

■ Application for the Electromagnet: GL600-F

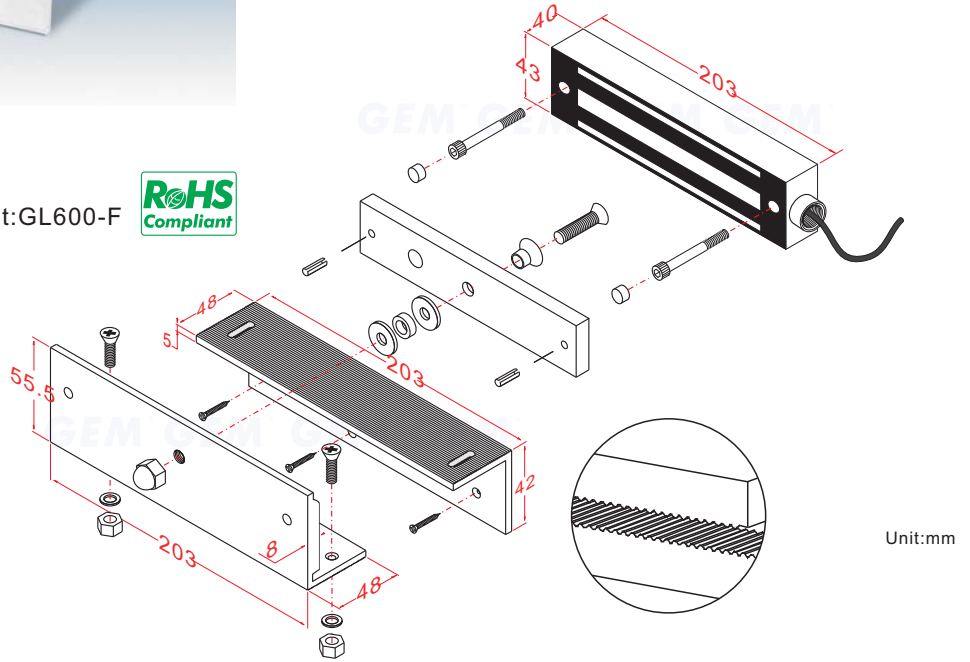

### Installation Steps of Z bracket for In-swinging doors

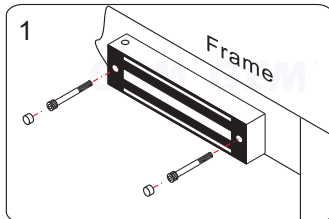

1 Tighten the electromagnetic lock on the L bracket by using the fixing screw.

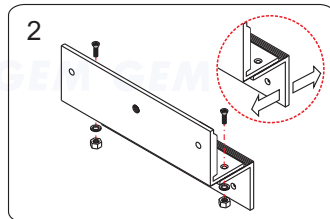

2 Assemble the Z bracket, and make sure that the Z bracket is adjustable.

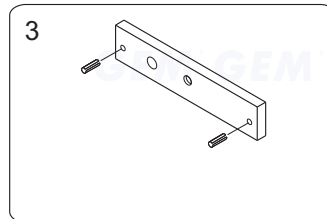

3 Insert the guide pins into the armature plate.

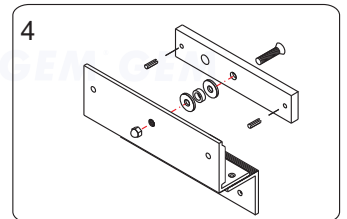

4 Put one rubber washer between armature plate and the Z bracket.

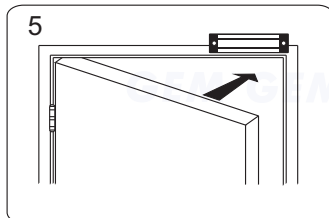

5 Close the door. Measure the correct position by bringing the armature plate close to the contact surface of the electromagnetic lock.

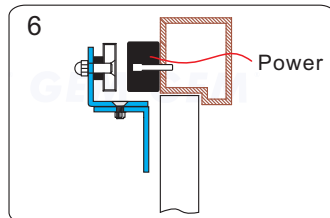

6 Turn on the power of EM-Lock, and let the armature plate bonds to the EM-lock. Adjust the position between the Z bracket and the door frame.

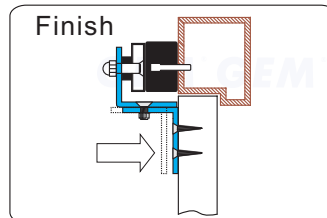

Finish Once the position is correct, use the screws to permanently mount the Z bracket on the door frame. This should be the last step.

### GIANNI INDUSTRIES, INC.

No. 13, Zhong Sing Road, Tu-Cheng Industrial Zone,  
 Tu-Cheng City, Taipei, Taiwan 23678  
 Tel: 886-2 2267 7986 / Fax: 886-2 2267 9876  
 E-Mail: info@gianni.com.tw  
 Website: gianni.tw  
 Copyright 2008 Gianni industries, inc. All rights reserved.  
 DM-CA-Z-GL600 Ver. C Published on 2008.05.29



The products are manufactured under an ISO 9001 & QC 080000 Certified Quality Management Program environment back its product quality, performance and commitment to customer satisfaction.

## Free Manuals Download Website

<http://myh66.com>

<http://usermanuals.us>

<http://www.somanuals.com>

<http://www.4manuals.cc>

<http://www.manual-lib.com>

<http://www.404manual.com>

<http://www.luxmanual.com>

<http://aubethermostatmanual.com>

Golf course search by state

<http://golfingnear.com>

Email search by domain

<http://emailbydomain.com>

Auto manuals search

<http://auto.somanuals.com>

TV manuals search

<http://tv.somanuals.com>