

GS-SR125EDL

Rack Mount Server

User's Manual

Dual Xeon™ Processor Motherboard / Server Solution

Rev. 1001

25A08-05EDL-C00

Table of Content

Safety, Care and Regulatory Information	4
Introduction	8
Contents Packages	8
WARNING!	8
Chapter 1 Features Summary	9
Chapter 2 System Hardware Installation	11
Step 2-1: Chassis Removal	11
Step 2-2: CPU Installation	11
Step 2-3: Heat Sink Installation	12
Step 2-4: Memory Installation	12
Step 2-5: PCI Expansion Card Installation	13
Step 2-6: Hard Disk Drive Installation	14
Step 2-7: FAN Duct Installation	15
Step 2-8: Reinstall Top Cover	15
Chapter 3 Appearance of GS-SR125EDL	16
3-1: Front View of GS-SR125EDL	16
3-2: Rear View of GS-SR125EDL	17
3-3: IDE Backplane Layout and Description	18
3-4: Switch and LED Indicators Description	19
3-5: HDD LED Indicators Description	20
3-6 : Connector Icon Description	21
Chapter 4 Motherboard Layout & Jumper Setting Introduction	22
GA-8EGPDRE Motherboard Layout	22
GA-8EGPDRE Motherboard Layout Description	23
Chapter 5 BIOS Setup	33
Main	35
Advanced	38
Advanced Processor Option	39
PCI Configuration	40

Table of Content

Cache Memory	41
I/O Device Configuration	43
Console Redirection	45
Security	48
Boot	50
Exit	51
Chapter 6 Appendix	53
6-1: Acronyms	53

Safety, Care and Regulatory Information

▮ Important safety information

Read and follow all instructions marked on the product and in the documentation before you operate your system. Retain all safety and operating instructions for future use.

- * The product should be operated only from the type of power source indicated on the rating label.
- * If your computer has a voltage selector switch, make sure that the switch is in the proper position for your area. The voltage selector switch is set at the factory to the correct voltage.
- * The plug-socket combination must be accessible at all times because it serves as the main disconnecting device.
- * All product shipped with a three-wire electrical grounding-type plug only fits into a grounding-type power outlet. This is a safety feature. The equipment grounding should be in accordance with local and national electrical codes. The equipment operates safely when it is used in accordance with its marked electrical ratings and product usage instructions.
- * Do not use this product near water or a heat source.
- * Set up the product on a stable work surface or so as to ensure stability of the system.
- * Openings in the case are provided for ventilation. Do not block or cover these openings. Make sure you provide adequate space around the system for ventilation when you set up your work area. Never insert objects of any kind into the ventilation openings.
- * To avoid electrical shock, always unplug all power cables and modem cables from the wall outlets before removing covers.
- * Allow the product to cool before removing covers or touching internal components.

▮ Precaution for Product with Laser Devices

Observe the following precautions for laser devices:

- * Do not open the CD-ROM drive, make adjustments, or perform procedures on a laser device other than those specified in the product's documentation.
- * Only authorized service technicians should repair laser devices.

▮ Precaution for Product with Modems, Telecommunications, or Local Area Network Options

Observe the following guidelines when working with options:

- * Do not connect or use a modem or telephone during a lightning storm. There may be a risk of electrical shock from lightning.

- * To reduce the risk of fire, use only No. 26 AWG or larger telecommunications line cord.
- * Do not plug a modem or telephone cable into the network interface controller (NIC) receptacle.
- * Disconnect the modem cable before opening a product enclosure, touching or installing internal components, or touching an uninsulated modem cable or jack.
- * Do not use a telephone line to report a gas leak while you are in the vicinity of the leak.

📌 Federal Communications Commission (FCC) Statement

Note: This equipment has been tested and found to comply with the limits for a Class B digital device, pursuant to Part 15 of the FCC Rules. These limits are designed to provide reasonable protection against harmful interference when the equipment is operated in a commercial environment. This equipment generates, uses, and can radiate radio frequency energy and, if not installed and used in accordance with the instruction manual, may cause harmful interference to radio communications. Operation of this equipment in a residential area is likely to cause harmful interference in which case the user will be required to correct the interference at his own expense.

Properly shielded and grounded cables and connectors must be used in order to meet FCC emission limits. Neither the provider nor the manufacturer are responsible for any radio or television interference caused by using other than recommended cables and connectors or by unauthorized changes or modifications to this equipment. Unauthorized changes or modifications could void the user's authority to operate the equipment.

This device complies with Part 15 of the FCC Rules. Operation is subject to the following two conditions:

- (1) this device may not cause harmful interference, and
- (2) this device must accept any interference received, including interference that may cause undesired operation.

📌 FCC part 68 (applicable to products fitted with USA modems)

The modem complies with Part 68 of the FCC Rules. On this equipment is a label that contains, among other information, the FCC registration number and Ringer Equivalence Number (REN) for this equipment. You must, upon request, provide this information to your telephone company.

If your telephone equipment causes harm to the telephone network, the Telephone Company may discontinue your service temporarily. If possible, they will notify in advance. But, if advance notice is not practical, you will be notified as soon as possible. You will be informed of your right to file a complaint with the FCC.

Your telephone company may make changes in its facilities, equipment, operations, or procedures that could affect proper operation of your equipment. If they do, you will be notified in advance to give you an opportunity to maintain uninterrupted telephone service.

The FCC prohibits this equipment to be connected to party lines or coin-telephone service.

The FCC also requires the transmitter of a FAX transmission be properly identified (per FCC Rules Part 68, Sec. 68.381 (c) (3)).

/ for Canadian users only /

Canadian Department of Communications Compliance Statement

This digital apparatus does not exceed the Class B limits for radio noise emissions from digital apparatus as set out in the radio interference regulations of Industry Canada.

Le présent appareil numérique n'émet pas de bruits radioélectriques dépassant les limites applicables aux appareils numériques de Classe B prescrites dans le règlement sur le brouillage radioélectrique édicté par Industrie Canada.

DOC notice (for products fitted with an Industry Canada-compliant modem)

The Canadian Department of Communications label identifies certified equipment. This certification means that the equipment meets certain telecommunications network protective, operational and safety requirements. The Department does not guarantee the equipment will operate to the user satisfaction. Before installing this equipment, users ensure that it is permissible to be connected to the facilities of the local Telecommunications Company. The equipment must also be installed using an acceptable method of connection. The customer should be aware that compliance with the above conditions might not prevent degradation of service in some situations.

Repairs to certified equipment should be made by an authorized Canadian maintenance facility designated by the supplier. Any repairs or alterations made by the user to this equipment, or equipment malfunctions, may give the telecommunications company cause to request the user to disconnect the equipment.

Users should ensure for their own protection that the electrical ground connections of the power utility, telephone lines and internal metallic water pipe system, if present are connected together. This precaution may be particularly important in rural areas.

Caution: Users should not attempt to make such connections themselves, but should contact the appropriate electric inspection authority, or electrician, as appropriate.

NOTICE: The Load Number (LN) assigned to each terminal device denotes the percentage of the total load to be connected to a telephone loop which is used by the device, to prevent overloading. The termination on a loop may consist of any combination of devices subject only to the requirement that the sum of the Load Numbers of all the devices does not exceed 100.

/ for European users only /



CAUTION

- ❖ Danger of explosion if battery is incorrectly replaced.
- ❖ Replace only with the same or equivalent type recommended by the manufacturer.
- ❖ Dispose of used batteries according to the manufacturer's instructions.



Introduction

Welcome to Gigabyte GS-SR125EDL Rack mount Server System Installation Guide. The guide provides instructions for configuration hardware for the GS-SR125EDL your system.

This installation guide will assist you in installing all the essential components for the server system. For your protection, please read and understand all of the safety and operating instructions regarding your Gigabyte Server and retain for future reference. The procedures in this guidebook assume that you are a system or network administrator experienced in installing similar hardware.

Contents Packages

When opening the package, please ensure the system components are not damaged during the shipping. Using the following checklist to verify the contents. If any component is missing or damaged in the system, please contact your vendor immediately.

- | | |
|---|--|
| <input checked="" type="checkbox"/> Chassis | <input checked="" type="checkbox"/> Power Supply (Installed) |
| <input checked="" type="checkbox"/> The 8EGPDRE Motherboard | <input checked="" type="checkbox"/> Slim type CD-ROM drive (Installed) |
| <input checked="" type="checkbox"/> Two CPU Heat Sinks | <input checked="" type="checkbox"/> Four Hard Disk Drive Trays |
| <input checked="" type="checkbox"/> GS-SR125EDL System Installation Guide | <input checked="" type="checkbox"/> Driver CD for motherboard driver & utility |
| <input checked="" type="checkbox"/> USB Floppy Drive (Optional Packages) | |



WARNING!

Computer motherboards and expansion cards contain very delicate Integrated Circuit (IC) chips. To protect them against damage from static electricity, you should follow some precautions whenever you work on your computer.

1. Unplug your computer when working on the inside.
2. Use a grounded wrist strap before handling computer components. If you do not have one, touch both of your hands to a safely grounded object or to a metal object, such as the power supply case.
3. Hold components by the edges and try not touch the IC chips, leads or connectors, or other components.
4. Place components on a grounded antistatic pad or on the bag that came with the components whenever the components are separated from the system.
5. Ensure that the ATX power supply is switched off before you plug in or remove the ATX power connector on the motherboard.

Chapter 1 Features Summary

Motherboard	<ul style="list-style-type: none"> GA-8EGPDRE
Processor Supported	<ul style="list-style-type: none"> Dual socket 604 for Intel® FC-PGA Xeon™ processor supports up to 3.06GB Intel® Xeon 533MHz FSB
Chipset	<ul style="list-style-type: none"> ServerWorks CMIC-SL Northbridge ServerWorks CIOB-E Dual Gigabit LAN and PCI-X Bridge ServerWorks CSB6 Southbridge
System Memory:	
Memory Capacity	<ul style="list-style-type: none"> 4 x 184-pin DDR266 DIMM Sockets Supports 4GB Maximum Capacity
Memory Type	<ul style="list-style-type: none"> DDR266; Registered DDR
DIMM Size	<ul style="list-style-type: none"> 64MB, 128MB, 256MB, 512MB, 1GB
Memory Voltage	<ul style="list-style-type: none"> 2.5V only
Error Correction:	<ul style="list-style-type: none"> Single-bit Errors Correction, Multiple-bit Errors Detection
Expansion Slot	<ul style="list-style-type: none"> 1 x Riser card with one full-height/full-length PCI-X 1 x Riser card with low-profile half-length PCI slot
Drive Bay:	
Hard Disk Drives:	<ul style="list-style-type: none"> 4 x IDE HDD
Floppy Drive	<ul style="list-style-type: none"> USB Floppy (Optional)
Slim Type CDROM	<ul style="list-style-type: none"> 1 Slim type CD-ROM
Cooling Fans:	<ul style="list-style-type: none"> 4 X Redundant System Fan 1 X Power Fan
Integrated LANs:	
Controller	<ul style="list-style-type: none"> ServerWorks CIOB-E Gigabit Ethernet Controllers x 2
Bus	<ul style="list-style-type: none"> PCI 64Bit/33 MHz PCI-X 64Bit/133 MHz
Advanced Software Function	<ul style="list-style-type: none"> Adapter Fault Tolerance Adaptive Load Balancing
Integrated Graphics:	
Controller	<ul style="list-style-type: none"> ATI® RAGE-XL VGA Controller
Graphics Memory	<ul style="list-style-type: none"> 8MB SDRAM

Integrated Super I/O:

- | | |
|----------------|---|
| Serial Ports | <ul style="list-style-type: none">• 1 x Serial Port COM1 (Rear I/O-Shield)• 1 x Serial Port COM2 (Front I/O Shield) |
| Keyboard/Mouse | <ul style="list-style-type: none">• Both Support Console Redirection• 1 x PS/2 Keyboard Port (Rear I/O-Shield)• 1 x PS/2 Mouse Port (Rear I/O-Shield) |
| USB: 1.1 | <ul style="list-style-type: none">• 2 x USB ports (Rear I/O-Shield)• 2 x USB Port (Front Panel) |
-

System BIOS:

- | | |
|------------------|--|
| BIOS Type | <ul style="list-style-type: none">• Phoenix® BIOS, Multi-bootBBS 1.0Compliant4Mb Flash Memory |
| Special Features | <ul style="list-style-type: none">• ACPI 1.1, DMI, WFM, PXE, Plug and Play, A/C Power Recovery |
-

Server Management Functions:(Optional)

- | | |
|-------------------|--|
| BMC Chip | <ul style="list-style-type: none">• NS IPMI 1.5 controller |
| Failure Detection | <ul style="list-style-type: none">• IPMI 1.5 specification of Server management |
| Event Logging | <ul style="list-style-type: none">• 32KB Nonvolatile Memory to Log System Failure Events |
| Remote Management | <ul style="list-style-type: none">• Follow the IPMI 1.5 specification of Server management |
-

Environment

- | | |
|---------------------|---|
| Ambient Temperature | <ul style="list-style-type: none">• Operating Temperature: 5°C to 35°C• Non-operating Temperature: 0°C to 50°C |
| Relative Humidity | <ul style="list-style-type: none">• 10-85% operating Humidity at 30° C |
-

Safety Regulations

- CE, FCC, BSMI, UL
-

System:

- Width: 430mm/19", Depth: 650mm/25.5, Height: 43.2mm
-

Electrical Power Supply:

- | | |
|--------------------------|--|
| AC Voltage and Frequency | <ul style="list-style-type: none">• 100V/240V; 47Hz/63Hz |
| DC Power Supply | <ul style="list-style-type: none">• 350W |
-

Chapter 2 System Hardware Installation



Please observe the safety information in chapter '§ Important Safety Information'. Do not expose the server to extreme environmental conditions. Protect it from dust, humidity, and heat.

Step 2-1: Chassis Removal

Step 1 Push down the two buttons located at two sides of the chassis.

Step 2 And slide toward to remove the top cover.

After removing the top cover, you can install CPU and other essential components.

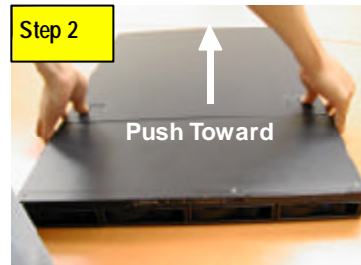

Step 2-2: CPU Installation



Please make sure the CPU type and speed that are supported by the motherboard.

Step 1 To install the CPU(s), lift up the bar that located next to the socket.

Step 2 The noticed corner should point toward the end of lever. The CPU will only fit in the orientation as shown below.

Step 3 Then, align the CPU and insert it into the socket. Then, push the lever to the original position.

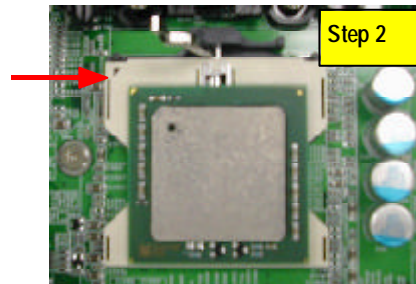
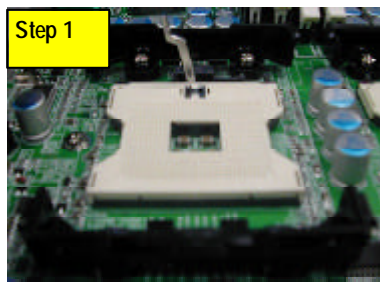

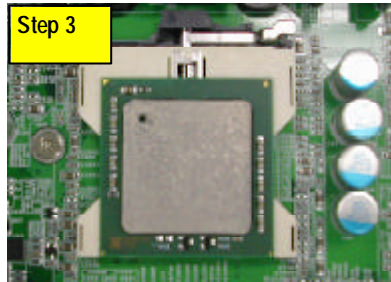

Step 2-3: Heat Sink Installation

Step 1 To install the heat sink, just simply put it on the retention module.

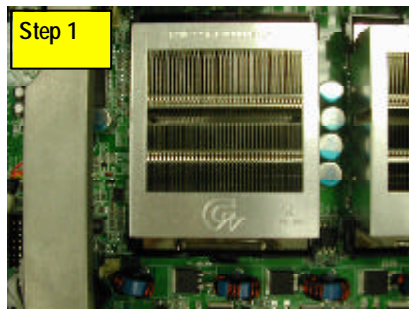

Step 2-4: Memory Installation

Step 1 The DIMM slot has a notch, the DIMM memory module only fit in one direction.

Step 2 Align the memory notch to the module and push the memory into the DIMM socket.

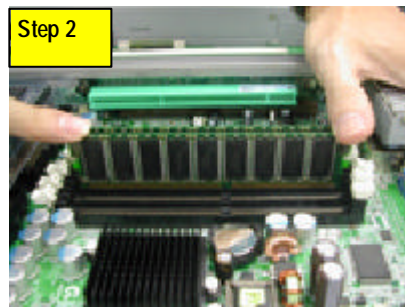
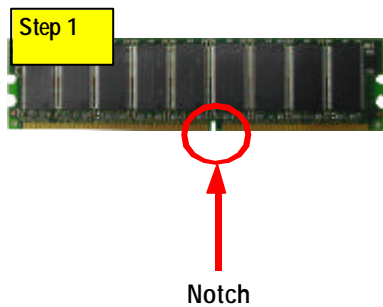

Step 2-5: PCI Expansion Card Installation



PCI Slot 2 is not compliance with this model.

GS-SR125EDL provides expansion riser slots for two peripheral cards, 100/133MHz , one full-height/ one half-length. To install the peripheral, please go through the following steps.

Step 1 Remove the screws on the riser bracket.

Step 2 Detach the riser bracket with both hands.

Step 3 Installing the PCI Riser card. To install the riser card, just simply push it into the module.

Step 4 Secure the card with screws.

Repeat **Step 3 & 4** to install the rest of add-on cards.

Step 5 Finally, align the stable racks to the system module (see the arrow direction mark 1), and push down vertically.

Step 6 Reverse Step 1 & 2 to secure the riser bracket firmly. Installation completed.

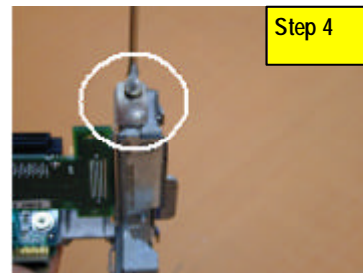
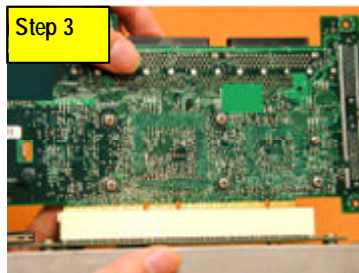
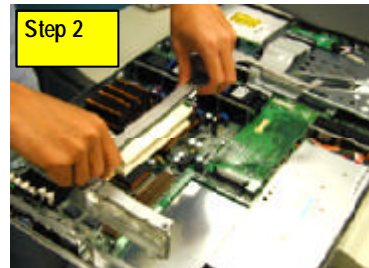
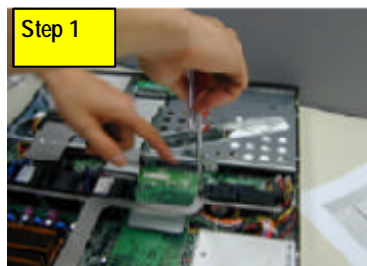

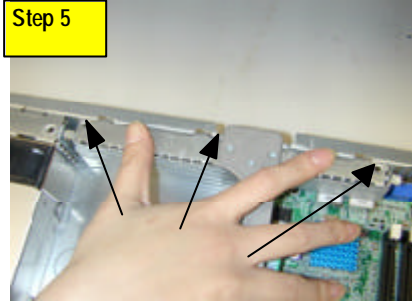

Step 2-6: Hard Disk Drive Installation

- Step 1 Pull the hard disk drive tray handle and remove the tray from the chassis.
- Step 2 Insert the hard disk drive into the tray.
- Step 3 Secure each hard disk drive with 4 screws.
- Step 4 After securing the hard disk drive with the screws, hold the hard drive handle at open position, place the tray into chassis and push the hard disk drive tray handle to the locked position.

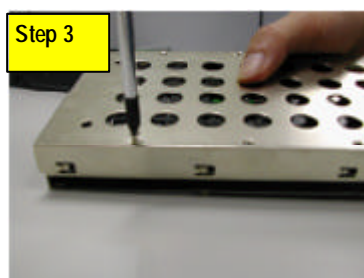
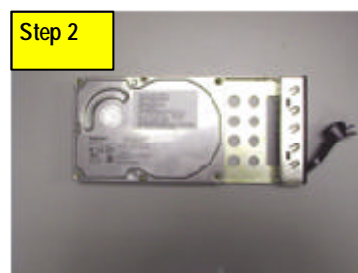

Step 2-7: FAN Duct Installation

Step 1 Place the fan duct on the top of heat sinks.

Step 2 Fasten the fan duct with two screws.

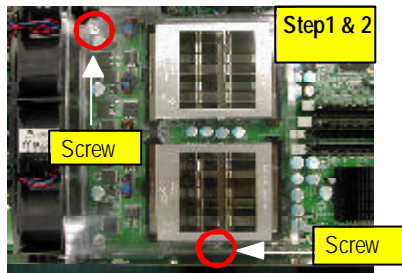

Step 2-8: Reinstall Top Cover

Step 1 Gently apply force to the indentures with your thumbs and push toward the chassis (See the arrow direction) to the lock position.

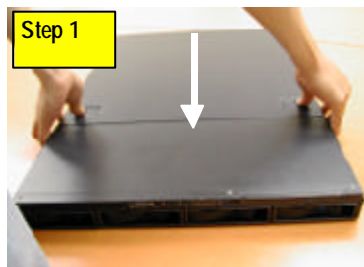

Chapter 3 Appearance of GS-SR125EDL

3-1: Front View of GS-SR125EDL

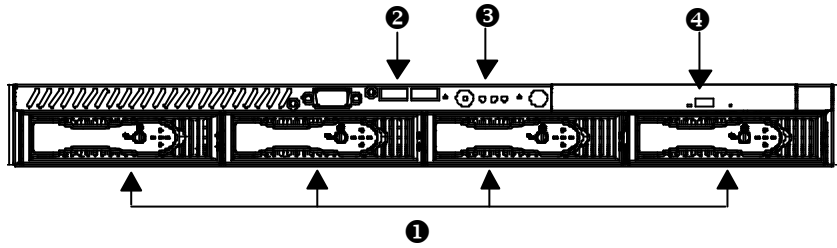

①	IDE HDD
②	USB Connectors
③	System LED
④	CD-ROM Disk

3-2: Rear View of GS-SR125EDL

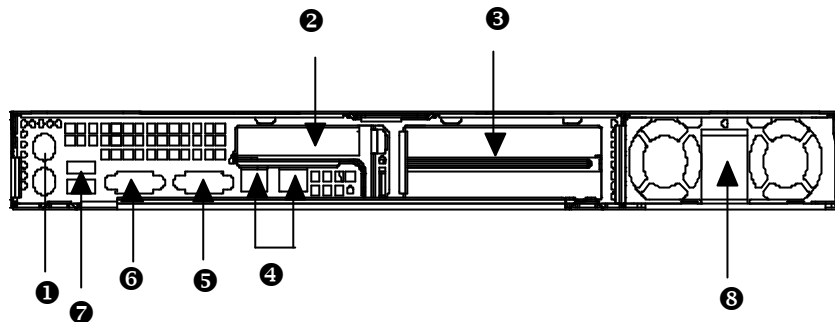

①	PS/2 Keyboard & Mouse Connector
②	Low Profile
③	Full-Height / Full- Length
④	LAN 1 / 2 Ports
⑤	VGA Port
⑥	COM Port
⑦	USB Connectors
⑧	Power Connector

3-3: IDE Backplane Layout and Description

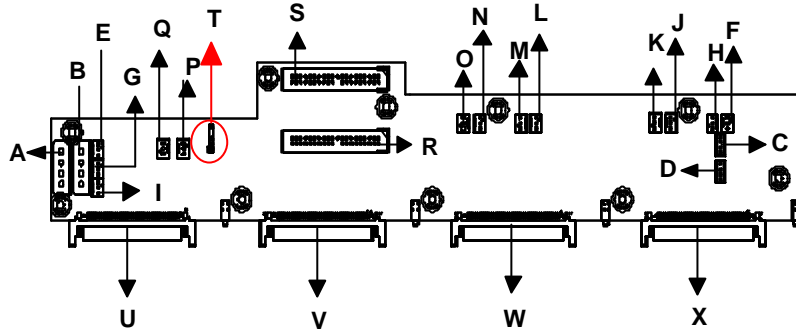

A ,C ,D	Power	G	FAN9
F , H	FAN1	I	FAN10
K , J	FAN2	R	IDE1
M , L	FAN3	S	IDE2
O, N	FAN4	T	SMBUS1
P	FAN5	U	CON1 (SCA80-1)
Q	FAN6	V	CON2 (SCA80-2)
E	FAN7	W	CON3 (SCA80-3)
B	FAN8	X	CON4 (SCA80-4)

3-4: Switch and LED Indicators Description

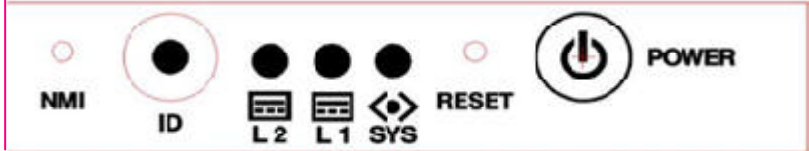





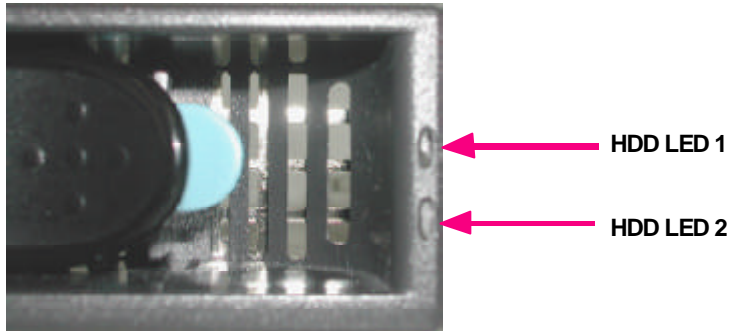

	Acting	Color	Status
Power LED	On	Green	Power On
	On	Amber	Power cable is plugged in
	Blink	Green	System stands by
	Off	N/A	No power
SYS LED	On	Amber	System is ready but degraded: some CPU Fault, DIMM Killed Critical PowerModules Failure, Critical FANs Failure, Voltage (Power Supply), critical Temperature and Voltage
	Off	N/A	Normal temperature and voltage
LAN LED	On	Green	LANonline
	Off	N/A	LANoffline
	Blink	Green	LANactive
ID (Service LED)	On	Blue	Identified by users
	Off	N/A	N/A

3-5: HDD LED Indicators Description



	Acting	Color	Status
HDD LED 1	Off	N/A	HDD power off
HDD LED 1	On	Green	HDD power on
HDD LED 2	Off	N/A	HDD non-active
HDD LED 2	Blink	Green	HDD active

3-6 : Connector Icon Description

Suggest Icon	Description
	Keyboard
	VGA
	Mouse
	LAN
	Parallel Port
	Serial Port
	USB

Chapter 4 Motherboard Layout & Jumper Setting

GA-8EGPDRE Motherboard Layout

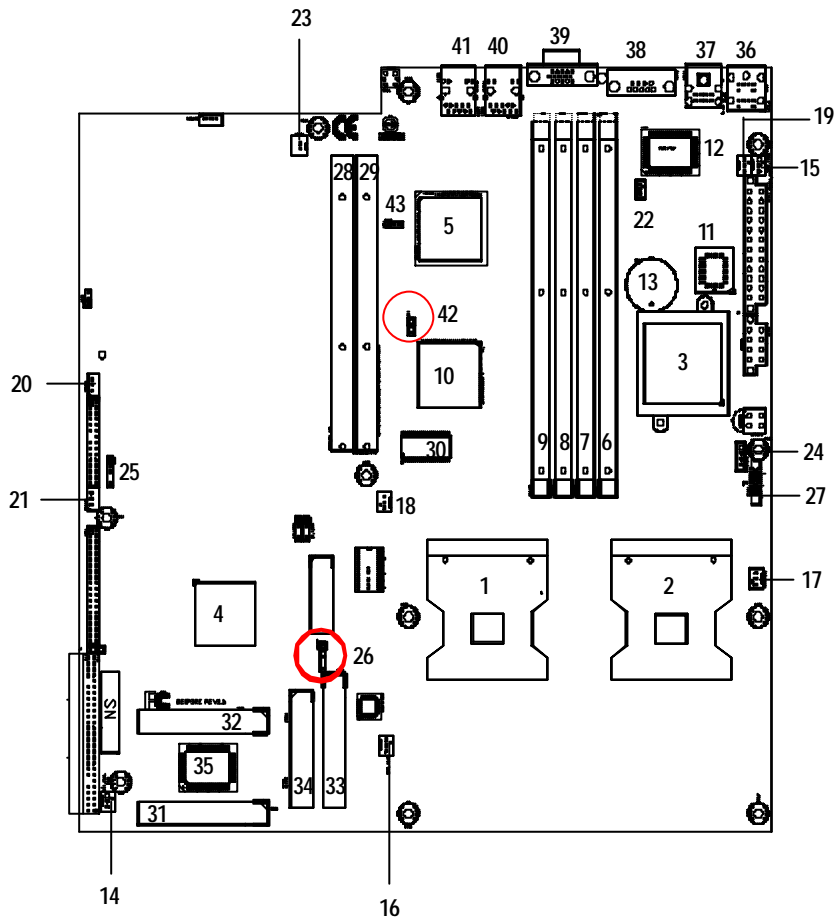

GA-8EGPDRE Motherboard Layout Description

1	CPU2 (Install First)	23	WOM1
2	CPU1	24	PWRDET1
3	CMIC-SL	25	SMBUS1
4	CSB6	26	SMBUS2
5	CIOBE	27	FFC1
6	DIMM1	28	PCIXSLOT2
7	DIMM2	29	PCI64_SLOT
8	DIMM3	30	Graphic Memory
9	DIMM4	31	IDE2
10	ATI Rage XL	32	IDE1
11	BIOS	33	IDE3
12	VS312AB	34	FDD1
13	BT1	35	Giga RAID
14	SYS_FAN1	36	KB_MS
15	SYS_FAN2	37	USB2
16	SYS_FAN3	38	COM1
17	CPU_FAN1	39	VGA
18	CPU_FAN2	40	GLAN1
19	POWER_FAN1	41	GLAN2
20	IPMB1	42	JP6
21	IPMB2	43	JP9
22	WOL1	44	

13) BT1 (Battery)

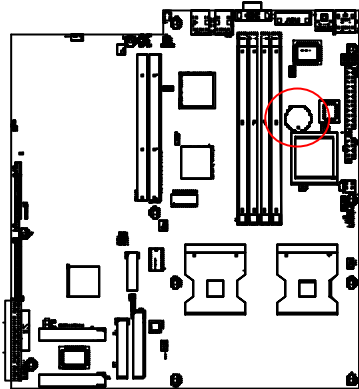

Li-Battery 3V

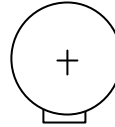

CAUTION

- ❖ Danger of explosion if battery is incorrectly replaced.
- ❖ Replace only with the same or equivalent type recommended by the manufacturer.
- ❖ Dispose of used batteries according to the manufacturer's instructions.

14 / 15 / 16) SYS_FAN1/2/3 (System Fan Connector)

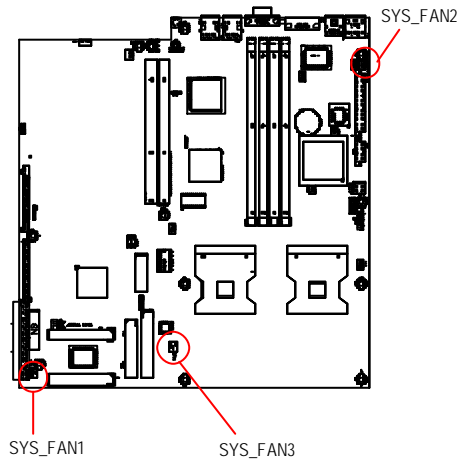

Pin No.	Definition
1	GND
2	+12v/Control
3	Sense

17 / 18) CPU_FAN1/2 (CPU Fan Connector)

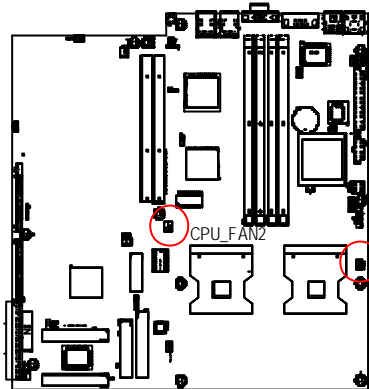

Pin No.	Definition
1	GND
2	+12v/Control
3	Sense

➤ Please note, a proper installation of the CPU cooler is essential to prevent the CPU from running under abnormal condition or damaged by overheating. The CPU fan connector supports Max. current up to 600mA .

19) POWER_FAN1 (Power Fan Connector)

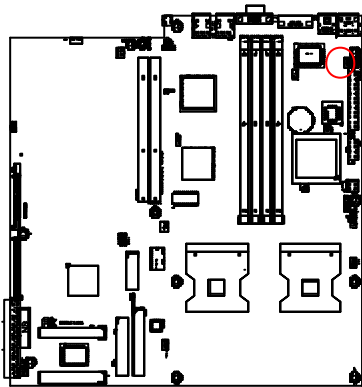

Pin No.	Definition
1	GND
2	+12v/Control
3	Sense

20 / 21) IPMB1/ IPMB 2 (IPMB Connector)

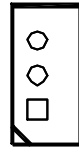
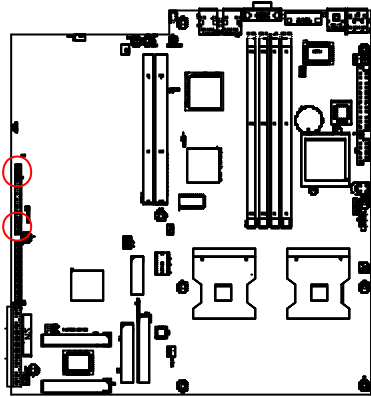

1

Pin No.	Definition
1	SCI_IPMB
2	GND
3	SDA_IPMB

22) WOL1 (Wake on LAN Connector)

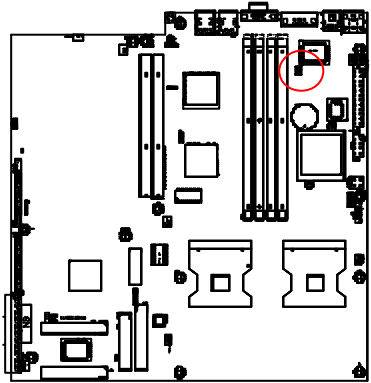

1

Pin No.	Definition
1	+5VSB
2	GND
3	Signal

23) WOM1 (Wake on Modem Connector)

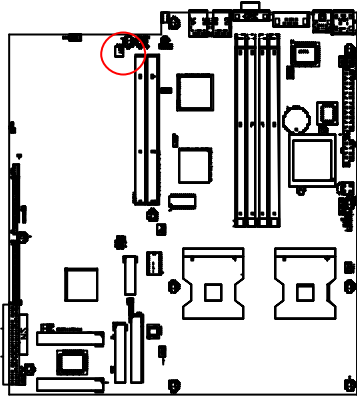

Pin No.	Definition
1	Signal
2	GND

24) PWRDET1 (Power Status Interface)

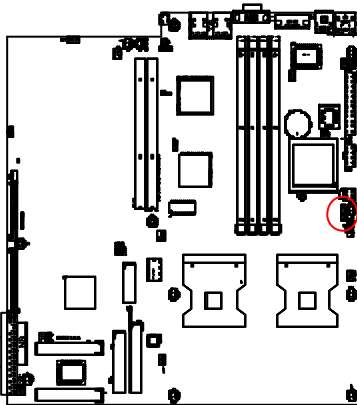

Pin	Definition
1	I2C_CLK
2	GND
3	I2C_Data
4	NC

25 / 26) SMBUS1 / 2 (SMBUS Connectors)

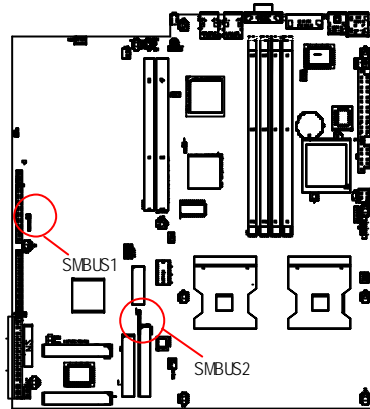

Pin	Definition
1	VCC
2	SDA
3	SCL
4	NC
5	GND

27) FFC1 (IPMB I2C Bus Connector)

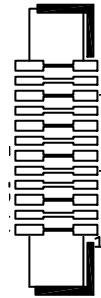
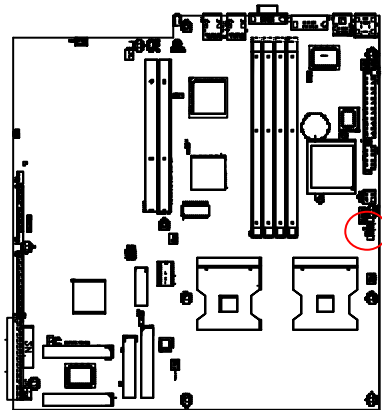

28 / 29) PCIX_SLOT2 / PCI64_SLOT(PCI Slots)

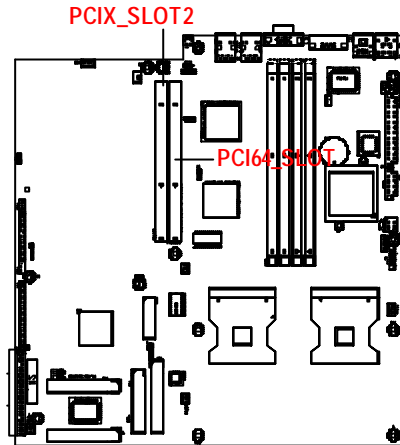

PCIX_SLOT2:
Supports full-height/full-length PCI-X

PCI64_SLOT:
Supports low-profile half-length PCI slot

31/ 32 /33) IDE2 /IDE1 / IDE3 (IDE1 / IDE2 / IDE3Connectors)

Important Notice:

Please connect first harddisk to IDE1 and connect CDROM to IDE2. The red stripe of the ribbon cable must be the same side with the Pin1.

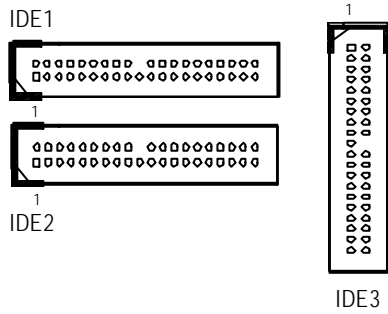
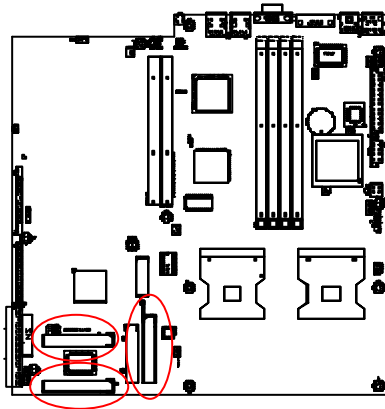

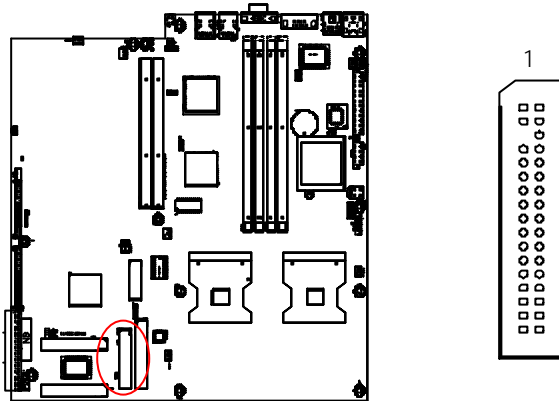

34) FDD1 (Floppy Connector)

Please connect the floppy drive ribbon cables to FDD. It supports 360K,720K,1.2M,1.44M and 2.88Mbytes floppy disk types. The red stripe of the ribbon cable must be the same side with the Pin1.



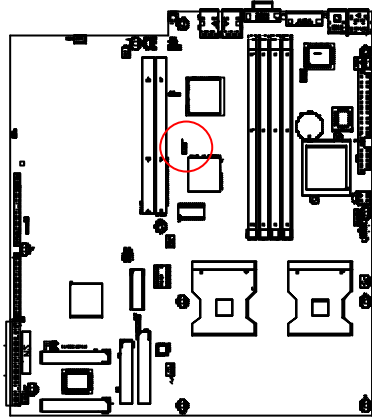



42) JP6 (PCIX_SLOT2 Bus Speed Functon)

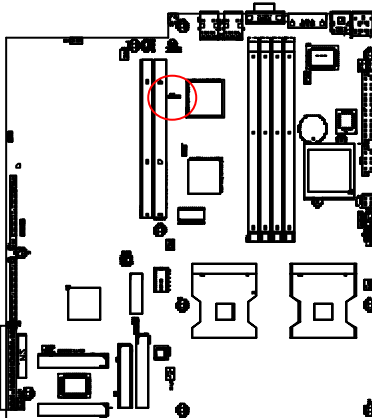

- 1  1-2 close: Set the PCI-X Bus Speed at 100MHz
- 1  2-3 close: Set the PCI-X Bus Speed at 133MHz (Default)

43) JP9 (PCI_SLOT1 Bus Speed Functon)



- 1  1-2 close: Conventional PCI Mode
- 1  2-3 close: PCI-X 66MHz(Default)
-  Open: Auto

Chapter 5 BIOS Setup

BIOS Setup is an overview of the BIOS Setup Program. The program that allows users to modify the basic system configuration. This type of information is stored in battery-backed CMOS RAM so that it retains the Setup information when the power is turned off.

ENTERING SETUP

Power ON the computer and press <F2> immediately will allow you to enter Setup.

CONTROL KEYS

<↑>	Move to previous item
<↓>	Move to next item
<←>	Move to the item in the left hand
<→>	Move to the item in the right hand
<Esc>	Main Menu - Quit and not save changes into CMOS Status Page Setup Menu and Option Page Setup Menu - Exit current page and return to Main Menu
<+/PgUp>	Increase the numeric value or make changes
<-/PgDn>	Decrease the numeric value or make changes
<F1>	General help, only for Status Page Setup Menu and Option Page Setup Menu
<F2>	Reserved
<F3>	Reserved
<F4>	Reserved
<F5>	Restore the previous CMOS value from CMOS, only for Option Page Setup Menu
<F6>	Reserved
<F7>	Load the Optimized Defaults
<F8>	Reserved
<F9>	Reserved
<F10>	Save all the CMOS changes, only for Main Menu

GETTING HELP**Main Menu**

The on-line description of the highlighted setup function is displayed at the bottom of the screen.

Status Page Setup Menu / Option Page Setup Menu

Press F1 to pop up a small help window that describes the appropriate keys to use and the possible selections for the highlighted item. To exit the Help Window press <Esc>.

- **Main**

This setup page includes all the items in standard compatible BIOS.

- **Advanced**

This setup page includes all the items of AMI special enhanced features.

(ex: Auto detect fan and temperature status, automatically configure hard disk parameters.)

- **Security**

Change, set, or disable password. It allows you to limit access the system and setup.

- **Boot**

This setup page include all the items of first boot function features.

- **Exit**

There are five options in this selection: Exit Saving Changes, Exit Discarding Changes, Load Optimal Defaults, Load Failsafe Defaults, and Discard Changes.

Main

Once you enter Phoenix BIOS Setup Utility, the Main Menu (Figure 1) will appear on the screen. Use arrow keys to select among the items and press <Enter> to accept or enter the sub-menu.

Phoenix BIOS Setup Utility				
Main	Advanced	Security	Boot	Exit
System Time:		[00:13:12]		Item Specific Help
System Date:		[04/30/2003]		
Legacy Diskte A		[1.44MB 3 ^{1/2}]		
▶ Primary IDE Master		[CD-ROM]		
▶ Primary IDE Slave		[None]		
※ System Memory		640KB		
※ Extended Memory		623264KB		
※ Language		[Englisg (US)]		
※ BIOS Version				
F1: Help	↑↓: Select Item	+ -: Change Values	F5: Setup Defaults	
Esc: Exit	←→: Select Menu	Enter: Select ▶ Sub-Menu	F10: Save&Exit	

Figure 1: Main

☞ System Time

The time is calculated based on the 24-hour military time clock. Set the System Time (HH:MM:SS)

☞ System Date

Set the System Date. Note that the "Day" automatically changed after you set the date.
(Weekend: DD: MM: YY) (YY: 1099~2099)



※ Indicates DISPLAY ONLY

Legacy Diskette A

This category identifies the type of floppy disk drive A that has been installed in the computer.

- ▶▶ None No floppy drive installed
- ▶▶ 360KB, 5^{1/4} in. 3^{1/2} inch AT-type high-density drive; 360K byte capacity
- ▶▶ 1.2MB, 3^{1/2} in. 3^{1/2} inch AT-type high-density drive; 1.2M byte capacity
- ▶▶ 720K, 3^{1/2} in. 3^{1/2} inch double-sided drive; 720K byte capacity
- ▶▶ 1.44M, 3^{1/2} in. 3^{1/2} inch double-sided drive; 1.44M byte capacity.
- ▶▶ 2.88M, 3^{1/2} in. 3^{1/2} inch double-sided drive; 2.88M byte capacity.

Note: The 1.25MB, 3^{1/2} reference a 1024 byte/sector Japanese media format. The 1.25MB, 3^{1/2} diskette requires 3-Mode floppy-disk drive.

IDE Primary Master, Slave / Secondary Master, Slave

The category identifies the types of hard disk from drive C to F that has been installed in the computer. There are two types: auto type, and manual type. Manual type is user-definable; Auto type which will automatically detect HDD type.

Note that the specifications of your drive must match with the drive table. The hard disk will not work properly if you enter improper information for this category.

If you select User Type, related information will be asked to enter to the following items. Enter the information directly from the keyboard and press <Enter>. Such information should be provided in the documentation form your hard disk vendor or the system manufacturer.

▶▶ TYPE

1-39: Predefined types.

Users: Set parameters by User.

Auto: Set parameters automatically. (Default Values)

CD-ROM/DVD-ROM: Use for ATAPI CD-ROM drives or double click [Auto] to set all HDD parameters automatically.

ATAPI Removable: Removable disk drive is installed here.

» **Multi-Sector Transfer**

This field displays the information of Multi-Sector Transfer Mode.

Disabled: The data transfer from and to the device occurs one sector at a time.

Auto: The data transfer from and to the device occurs multiple sectors at a time if the device supports it.

» **LBA Mode** This field shows if the device type in the specific IDE channel support LBA Mode.

» **32-Bit I/O** Enable this function to maximize the IDE data transfer rate.

» **Transfer Mode** This field shows the information of Transfer Mode.

» **Ultra DMA Mode** This field displays the DMA mode of the device in the specific IDE channel.

☞ **System Memory**

The POST of the BIOS will determine the amount of base (or conventional) memory installed in the system.

The value of the base memory is typically 512 K for systems with 512 K memory installed on the motherboard, or 640 K for systems with 640 K or more memory installed on the motherboard.

☞ **Exyended Memory**

The BIOS determines how much extended memory is present during the POST.

This is the amount of memory located above 1 MB in the CPU's memory address map.

☞ **Language**

This field displays the language that is applied by the current system.

☞ **BIOS version**

This field displays the information of BIOS version.

Advanced

Phoenix BIOS Setup Utility				
Main	Advanced	Security	Boot	Exit
<ul style="list-style-type: none"> ▶ Advanced Processor Option ▶ PCI Configuration ▶ Cache Memory ▶ I/O Device Configuration <ul style="list-style-type: none"> USB Host Controller [Disabled] Onboard PXE Function [Disabled] System After AC Back [Off] ▶ Console Redirection 				Item Specific Help
F1: Help	↑↓: Select Item	+ -: Change Values	F5: Setup Defaults	
Esc: Exit	←→: Select Menu	Enter: Select ▶ Sub-Menu	F10: Save&Exit	

Figure 2: Advanced

About This Section: Advanced

This section “Advanced” is divided into six sub-menus.

- ☛ Advanced Processor Option
- ☛ PCI Configuration
- ☛ Cache Memory
- ☛ I/O Device Configuration
- ☛ USB Host Controller
- ☛ Onboard PXE Function
- ☛ System After AC Back
- ☛ Console Redirection

With this section, allowing user to configure your system for basic operation. User can change the system's default boot-up sequence, keyboard operation, shadowing and security, etc.

Advanced Processor Option

Phoenix BIOS Setup Utility		
Advanced		
Advanced Processor Option		Item Specific Help
Fast String Operations	[Enabled]	
Compatible FPU COde	[Disabled]	
Spilt Lock Operations	[Enabled]	
F1: Help ↑↓: Select Item + -: Change Values F5: Setup Defaults Esc: Exit ←→: Select Menu Enter: Select ▶ Sub-Menu F10: Save&Exit		

Figure 2-1: Advanced Processor Option

Advanced Processor Option

▶ Fast String Operations

Set the CPU fast string features.

- ▶▶ Enabled Enable CPU fast string features. (Default)
- ▶▶ Disabled Disable this function.

▶ Compatible FPU Code

CPU compatible Floating Point Unit OPcode usage model.

- ▶▶ Enabled Enable CPU compatible FPU code.
- ▶▶ Disabled Disable this function. (Default)

▶ Spilt Lock Operation

CPU split-lock feature setting.

- ▶▶ Enabled Enable CPU spilt-lock features.
- ▶▶ Disabled Disable this function. (Default)

PCI Configuration

Phoenix BIOS Setup Utility	
Advanced	
PCI Configuration	Item Specific Help
PCI/PNP ISA UMB Region Exclusion PCI/PNP ISA IRQ Resource Exclusion ISA graphics device installed [No]	
F1: Help ↑↓: Select Item + -: Change Values F5: Setup Defaults Esc: Exit ←→: Select Menu Enter: Select ▶ Sub-Menu F10: Save&Exit	

Figure 2-2: PCI Configuration

☞ PCI Configuration

This section provide the additional setup menus for users to confiure PCI devices.

▶ PCI/PNP UMB Region Exclusion

Reserve specific upper memory blocks for use by legacy ISA devices.

▶ PCI/PNP ISA IRQ Resource Exclusion

Reserve specific IRQs for use by legacy ISA devices.

▶ ISA Graphics Device Installed

- ▶▶ Yes Enable ISA (NON-VGA) graphics devices to access palette data in PCI VGA device.
- ▶▶ No Disable ISA (NON-VGA) graphics devices to access palette data in PCI VGA device.

Cache Memory

Phoenix BIOS Setup Utility		
Advanced		
Cache Memory		Item Specific Help
▶ Memory Cache	[Enabled]	
▶ Cache System BIOS area	[Write Protect]	
▶ Cache Video BIOS area	[Write Protect]	
▶ Cache Base 0-512K	[Write Back]	
▶ Cache Base 512K-640K	[Write Back]	
▶ Extended Memory Area	[Write Back]	
▶ Cache A000-AFFF	[Disabled]	
▶ Cache B000-BFFF	[Disabled]	
▶ Cache C800-CFFF	[Disabled]	
▶ Cache CC00-CFFF	[Disabled]	
▶ Cache D000-DFFF	[Disabled]	
▶ Cache D400-D7FF	[Disabled]	
▶ Cache E000-E3FF	[Disabled]	
▶ Cache E400-F7FF	[Disabled]	
F1: Help	↑↓: Select Item	+ -: Change Values
Esc: Exit	←→: Select Menu	Enter: Select ▶ Sub-Menu
		F5: Setup Defaults
		F10: Save&Exit

Figure 2-3: Cache Memory

☞ Cache Memory

This section provide users to determines how to configure the specific block of memory.

▶ Memory Cache

Set the state of the memory.

- ▶▶ Enabled Enable the memory cache.
- ▶▶ Disabled Disable the memory cache. (Default)

▶ **Cache System BIOS area**

Controls caching of System BIOS area.

- ▶▶ Uncached System BIOS area is uncached.
- ▶▶ Write Protect Write/Saved settings is ignored. (Default)

▶ **Cache Video BIOS area**

Controls caching of Video BIOS area.

- ▶▶ Uncached Video BIOS area is uncached.
- ▶▶ Write Protect Write/Saved setting is ignored. (Default)

▶ **Cache Base 0-512K / 512K-640K**

Controls caching of 512K / 512K-640K base memory

- ▶▶ Uncached Video BIOS area is uncached.
- ▶▶ Write Through Writes are cached and sent to main memory at once.
- ▶▶ Write Protect Write/Saved settings is ignored.
- ▶▶ Write Back Writes are cached, but not sent to main memory until necessary.
(Default)

▶ **Cache Extended Memory Area**

Controls caching of system memory above one megabyte.

- ▶▶ Uncached Video BIOS area is uncached.
- ▶▶ Write Through Writes are cached and sent to main memory at once.
- ▶▶ Write Protect Write/Saved settings is ignored.
- ▶▶ Write Back Writes are cached, but not sent to main memory until necessary.
(Default)

▶ **Cache A000-AFFF / B000-BFFF / C800-CFFF / CC00-CFFF / D000-DFFF /
D400-D7FF / D800-DBFF / DC00-DFFF / E000-E3FF / E400-F7FF**

- ▶▶ Disabled This block is not cached. (Default)
- ▶▶ USWC Caching Uncached Speculative Write Combined.

I/O Device Configuration

Phoenix BIOS Setup Utility	
Advanced	
I/O Device Configuration	Item Specific Help
Serial Port A	[Auto]
Serial Port B	[Auto]
Floppy Disk controller	[Enabled]
Base I/O address	[Primary]
F1: Help ↑↓: Select Item + -: Change Values F5: Setup Defaults Esc: Exit ←→: Select Menu Enter: Select ▶ Sub-Menu F10: Save&Exit	

Figure 2-4: I/O Configuration

☞ I/O Device Configuration

▶ Serial Port A

This allows users to configure serial port A by using this option.

- ▶▶ Disabled Disable the configuration.
- ▶▶ Enabled Enable the configuration.
- ▶▶ Auto BIOS or O.S will select the configuration automatically.

▶ Serial Port B

This allows users to configure serial port B by using this option.

- ▶▶ Disabled Disable the configuration.
- ▶▶ Enabled Enable the configuration.
- ▶▶ Auto BIOS or O.S will select the configuration automatically.

▶ Floppy Disk Controller

Enable and disable the function of floppy disk controller.

- ▶▶ Disabled Disable the configuration.
- ▶▶ Enabled Enable the configuration.
- ▶▶ Auto BIOS or O.S will select the configuration automatically.

▶ Base I/O address

Set the base I/O address for the floppy disk controller by using this option.

- ▶▶ Primary Set the base I/O address to 3F0~3F7. (Default)
- ▶▶ Secondary Set the base I/O address to 370~377

☞ USB Host Controller

This option allows user to enable USB host controller.

- ▶▶ Enable Enable USB host controller. (Default Value)
- ▶▶ Disabled Disable this function.

☞ Onboard PXE Function

This option allows user to enable PXE function.

- ▶▶ Enable Enable PXE function.
- ▶▶ Disabled Disable this function. (Default Value)

☞ System After AC Back

- ▶▶ On State System power state when AC cord is re-plugged.
- ▶▶ Off State Do not power on system when AC power is back. (Default Value)
- ▶▶ Last State Set system to the last state when AC power is removed. Do not power on system when AC power is back.

Console Redirection

Phoenix BIOS Setup Utility		
Advanced		
Console Redirection		Item Specific Help
COM Port Address	[Disabled]	
Baud Rate	[19.2K]	
Console Type	[PC ANSI]	
Console Redirection	[Direct]	
Continue C.R after POST	[Off]	
# of Video pages to support	[1]	
F1: Help ↑↓: Select Item + -: Change Values F5: Setup Defaults Esc: Exit ←→: Select Menu Enter: Select ▶ Sub-Menu F10: Save&Exit		

Figure 2-5: Console Redirection

☞ Console Redirection

This option allow user to remote monitoring and controlling the BIOS by client computer.

▶ COM Port Address

Set the the COM Port address for Console Redirection by usine this option.

- ▶▶ COM A Attempt to redirect console via COM A.
- ▶▶ On-board COM B Attempt to redirect console via COM B.
- ▶▶ Disabled Disable Console Redirction. (Default Value)

👉 **Note:** If Console Redirection is set to Enabled, user is allowed to adjust the options of C.R Port Baud Rate and C.R after Post.

▶ Baud Rate

Enable the specified of C. R Port Baud Rate.

- ▶▶ 300 Enable the specific baud rate at 300.
- ▶▶ 1200 Enable the specific baud rate at 1200.
- ▶▶ 9600 Enable the specific baud rate at 9600.
- ▶▶ 19.2K Enable the specific baud rate at 19.2K. (Default)
- ▶▶ 38.4K Enable the specific baud rate at 38.4K.
- ▶▶ 57.6K Enable the specific baud rate at 57.6K.
- ▶▶ 115.2K Enable the specific baud rate at 115.2K.

▶ Console Type

Enable the specified Console Type.

- ▶▶ Options: PC-ANSI 7bit (Default), VT100, VT100 8bit, VT100F, VT-U TF8

▶ Flow Control

Enable the function of flow control.

- ▶▶ Options: CTS/RTS (Default), None, XON, XOFF

▶ Console Redirection

Identifies whether the console is connected directly to the system or a modem is functioned to connect.

- ▶▶ Direct Identifies the console is connected directly to the system. (Default)
- ▶▶ Via Modem Identifies the console is connected via the modem.

▶ **Continue C.R after POST**

Enable Console Redirection after O.S has loaded

- ▶▶ On Continue C.R after Power on Self Test.
- ▶▶ Off Disable this function. (Default)

▶ **# of Vedio pages to support**

This is the number of vedio pages to allocate for console redirection when vedio hardware is not available.

Security

Phoenix BIOS Setup Utility				
Main	Advanced	Security	Boot	Exit
		Set User Password	[Enter]	Item Specific Help
		Set Supervisor Password	[Enter]	
×		Password on boot	[Disabled]	
×		Fixed disk boot sector	[Normal]	
×		Diskette access	[Supervisor]	
		Virus check reminder	[Disabled]	
		System backup reminder	[Disabled]	
F1: Help	↑↓: Select Item	+ -: Change Values	F5: Setup Defaults	
Esc: Exit	←→: Select Menu	Enter: Select ▶ Sub-Menu	F10: Save&Exit	

Figure 3: Security

🔑 About This Section: Security

In this section, user can set either supervisor or user passwords, or both for different level of password securities. In addition, user also can set the virus protection for boot sector.

🔑 Set User Password

You can only enter but do not have the right to change the options of the setup menus. When you select this function, the following message will appear at the center of the screen to assist you in creating a password.

Type the password up to 6 characters in length and press <Enter>. The password typed now will clear any previously entered password from the CMOS memory. You will be asked to confirm the entered password. Type the password again and press <Enter>. You may also press <Esc> to abort the selection and not enter a specified password.

☞ **Set Supervisor Password**

You can install and change this options for the setup menus. Type the password up to 6 characters in length and press <Enter>. The password typed now will clear any previously entered password from the CMOS memory. You will be asked to confirm the entered password. Type the password again and press <Enter>. You may also press <Esc> to abort the selection and not enter a specified password or press <Enter> key to disable this option.

☞ **Password on boot**

Password entering will be required when system on boot.

- ▶▶ Enabled Requires entering password when system on boot.
- ▶▶ Disabled Disable this function. (Default)

☞ **Fixed disk boot sector**

- ▶▶ Write Protect Write protects boot sector on harddisk to protect against virus.
- ▶▶ Normal Set the fixed disk boot sector at Normal state. (Default)

☞ **Virus check reminder**

- ▶▶ Daily Daily displays virus check reminder message at boot.
- ▶▶ Every Monday Displays virus check reminder message at boot at every Monday.
- ▶▶ 1st of every month Displays virus check reminder message at boot at the 1st of every month.
- ▶▶ Disabled Disable this function. (Default)

☞ **System back up reminder**

- ▶▶ Daily Daily displays system backup reminder message at boot.
- ▶▶ Every Monday Displays system backup reminder message at boot at every Monday.
- ▶▶ 1st of every month Displays system backup reminder message at boot at the 1st of every month.
- ▶▶ Disabled Disable this function. (Default)

Boot

Phoenix BIOS Setup Utility				
Main	Advanced	Security	Boot	Exit
+ Removable Device			Item Specific Help	
+ Hard Drive				
CD-ROM Drive				
F1: Help	↑↓: Select Item	+ -: Change Values	F5: Setup Defaults	
Esc: Exit	← →: Select Menu	Enter: Select	▶ Sub-Menu	F10: Save&Exit

Figure 4: Boot

🔗 About This Section: Boot

The "Boot" menu allows user to select among four possible types of boot devices listed using the up and down arrow keys. By applying <+> and <Space> key, you can promote devices and by using the <-> key, you can demote devices. Promotion or demotion of devices alerts the priority that the system uses to search for boot device on system power on.

🔗 Boot Device Priority

▶ Removable Device / Hard Drive / CD-ROM Drive

These three fields determines which type of device the system attempt to boot from after **PhoenixBIOS Post** completed. Specifies the boot sequence from the available devices. If the first device is not a bootable device, the system will seek for next available device.

Exit

Phoenix BIOS Setup Utility				
Main	Advanced	Security	Boot	Exit
Exit Saving Changes			Item Specific Help	
Exit Discarding Changes				
Load Setup Default				
Discard Changes				
Save Changes				
F1: Help	↑↓: Select Item	+ -: Change Values	F5: Setup Defaults	
Esc: Exit	←→: Select Menu	Enter: Select ▶ Sub-Menu	F10: Save&Exit	

Figure 5: Exit

🔑 About This Section: Security

Once you have changed all of the set values in the BIOS setup, you should save your changes and exit BIOS setup program. Select **"Exit"** from the menu bar, to display the following sub-menu.

- Exit Saving Changes
- Exit Discarding Changes
- Load Setup Default
- Discard Change
- Save Changes

🔑 Exit Saving Changes

This option allows user to exit system setup with saving the changes.

Press <Enter> on this item to ask for the following confirmation message:

Pressing 'Y' to store all the present setting values that user made in this time into CMOS.

Therefore, when you boot up your computer next time, the BIOS will re-configure your system according to data in CMOS.

Exit Discarding Changes

This option allows user to exit system setup without changing any previous settings values in CMOS. The previous selection remain in effect. This will exit the Setup Utility and restart your computer when selecting this option. Press <Enter> on this item to ask for confirmation message.

Load Setup Default

This option allows user to load default values for all setup items. When you press <Enter> on this item, you will get a confirmation dialog box with a message as below:

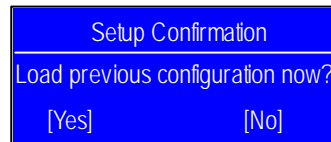
**Discard Changes**

This option allows user to load previous values from CMOS for all setup item. When you press <Enter> on this item, you will get a confirmation dialog box with a message as below:

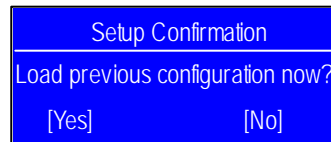

Press [Yes] to load the previous values from CMOS for all setup item.

Save Changes

This option allows user to save setup data to CMOS. When you press <Enter> on this item, you will get a confirmation dialog box with a message as below:

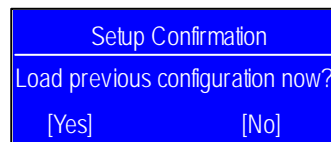

Press [Yes] to save setup data to CMOS.

Chapter 6 Appendix

6-1: Acronyms

Acronyms	Meaning
ACPI	Advanced Configuration and Power Interface
APM	Advanced Power Management
AGP	Accelerated Graphics Port
AMR	Audio Modem Riser
ACR	Advanced Communications Riser
BBS	BIOS Boot Specification
BIOS	Basic Input / Output System
CPU	Central Processing Unit
CMOS	Complementary Metal Oxide Semiconductor
CRIMM	Continuity RIMM
CNR	Communication and Networking Riser
DMA	Direct Memory Access
DMI	Desktop Management Interface
DIMM	Dual Inline Memory Module
DRM	Dual Retention Mechanism
DRAM	Dynamic Random Access Memory
DDR	Double Data Rate
ECP	Extended Capabilities Port
ESCD	Extended System Configuration Data
ECC	Error Checking and Correcting
EMC	Electromagnetic Compatibility
EPP	Enhanced Parallel Port
ESD	Electrostatic Discharge
FDD	Floppy Disk Device
FSB	Front Side Bus
HDD	Hard Disk Device
IDE	Integrated Dual Channel Enhanced
IRQ	Interrupt Request

Acronyms	Meaning
I/O	Input / Output
IOAPIC	Input Output Advanced Programmable Input Controller
ISA	Industry Standard Architecture
LAN	Local Area Network
LBA	Logical Block Addressing
LED	Light Emitting Diode
MHz	Megahertz
MIDI	Musical Instrument Digital Interface
MTH	Memory Translator Hub
MPT	Memory Protocol Translator
NIC	Network Interface Card
OS	Operating System
OEM	Original Equipment Manufacturer
PAC	PCI A.G.P. Controller
POST	Power-On Self Test
PCI	Peripheral Component Interconnect
RIMM	Rambus in-line Memory Module
SCI	Special Circumstance Instructions
SECC	Single Edge Contact Cartridge
SRAM	Static Random Access Memory
SMP	Symmetric Multi-Processing
SMI	System Management Interrupt
USB	Universal Serial Bus
VID	Voltage ID
ZCR	Zero Channel RAID

Free Manuals Download Website

<http://myh66.com>

<http://usermanuals.us>

<http://www.somanuals.com>

<http://www.4manuals.cc>

<http://www.manual-lib.com>

<http://www.404manual.com>

<http://www.luxmanual.com>

<http://aubethermostatmanual.com>

Golf course search by state

<http://golfingnear.com>

Email search by domain

<http://emailbydomain.com>

Auto manuals search

<http://auto.somanuals.com>

TV manuals search

<http://tv.somanuals.com>