

D V D + V C R C O M B O

DVR4550

USER'S GUIDE



SSC.4540.0121801

GO.VIDEO®

Congratulations...

...on your purchase of this Go-Video DVD+VCR!

We know you will enjoy this product for many years to come. In case warranty service is required, please take a moment to attach your receipt to this manual and write down your **Serial Number** (located on the back panel of the DVD+VCR): _____ .

CAUTION:

To prevent fire, shock hazard, or annoying interference, use only the recommended accessories.

To prevent electric shock, do not use this (polarized) plug with an extension cord, receptacle, or other outlet unless the blades can be fully inserted to prevent blade exposure.

To reduce the risk of electric shock, do not remove the unit cover or back. There are no serviceable parts inside. Refer servicing to qualified personnel only.

CUIDADO:

Para prevenir incendio, riesgo de choque, of interferencia enfadosa, use solamente los accesorios recomendados.

Para prevenir electrochoque, no use este enchufe (polarizado) con un cordón de extensión, toma de corriente, of cualquier otra toma a menos que los dientes puedan ser completamente insertados para prevenir exposición de los dientes.

Para reducir el riesgo de descarga eléctrica, no remueva la cubierta of la parte posterior del DVD+VCR. Dentro del DVD+VCR no hay partes que requieren servicio. Dirijase solamente a personal calificado cuando requiera servicio.

ATTENTION:

Pour éviter les incendis, risque de chocs, ou interférences fâcheuses, employer seulement les accessoires recommandés.

Pour éviter les chocs électriques, ne pas employer cette prise (polarisée) avec une rallonge, une prise de courant ou une autre sortie de courant à moins que les lames peuvent être insérées à fond pour l'exposition des lames.

Pour réduire les risques de chocs électriques, ne pas retirer le couvercle ou l'arrière du module. Il n'y a pas de pièce utilisable à l'intérieur. Ne faire effectuer l'entretien que par un personnel qualifié.

USER/INSTALLER CAUTION:

Your authority to operate this FCC certified equipment could be voided if you make changes or modifications not expressly approved by the manufacturer, who is responsible for compliance with Part 15 FCC rules.

NOTE TO CATV SYSTEM INSTALLER:



This reminder is provided to call the CATV system installer's attention to Article 820-40 of the National Electronic Code that provides guidelines for proper grounding and, in particular, specifies that the cable ground shall be connected to the grounding system of the building, as close to the point of cable entry as practical.

COPYRIGHT NOTICE

Federal law provides severe civil and criminal penalties for the unauthorized reproduction, distribution, or exhibition of copyrighted motion pictures and videotapes. (Title 17, United States Code, Sections 501 and 506).

MACROVISION NOTIFICATION

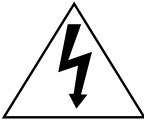
This product incorporates copyright protection technology that is protected by method claims of certain U.S. patents and other intellectual property rights owned by Macrovision Corporation and other rights owners. Use of this copyright protection technology must be authorized by Macrovision Corporation, and is intended for home and other limited viewing uses only unless otherwise authorized by Macrovision Corporation. Reverse engineering or disassembly is prohibited.

		<p>This symbol is intended to alert the user to the presence of uninsulated dangerous voltage within the product's enclosure that may be of sufficient magnitude to constitute risk of fire or electric shock.</p>
<p>CAUTION: TO REDUCE THE RISK OF ELECTRIC SHOCK DO NOT REMOVE COVER NO USER-SERVICEABLE PARTS INSIDE REFER SERVICING TO QUALIFIED SERVICE PERSONNEL</p>		<p>This symbol is intended to alert the user to the presence of important operating and maintenance instructions in the literature accompanying this product.</p>

Go-Video is a registered trademark of SONICblue Corporation. Dolby and the double-D symbol are trademarks of Dolby Laboratories Licensing Corp. DTS is a trademark of DTS Technology, LLC. VCR Plus+ and PlusCode are registered trademarks of Gemstar Development Corporation. The VCR Plus+ system is manufactured under license from Gemstar Development Corporation. All other brand and product names are trademarks or registered trademarks of their respective companies. © Copyright 2001-2002. SONICblue Corporation. All rights reserved.

<i>Important Safety Instructions</i>	iii
1 - GETTING STARTED	1
Unpacking	1
Basic Connections	2
Auto Setup	3
Remote Control Setup	4
2 - QUICK TOUR	5
Remote Control	5
DVD Control Keys	6
VCR Control Keys	7
Front Panel	8
Flap Door	9
Front Panel Display	10
Rear Panel	11
3 - BASIC OPERATIONS	12
Basic DVD Playback	12
Basic VCR Playback	13
Menu Navigation	14
4 - SPECIAL DVD FEATURES	15
Title/Chapter/Time Selection	15
Angle/Zoom	16
Subtitles/Audio/3D Sound	17
Repeat Features	18
Bookmarks	19
Random/Programmed Playback	20
MP3 Playback	21
5 - VCR RECORDING	22
Basic Recording	22
Record Settings	23
Copying From DVD to VHS	24
6 - TIMER RECORDING	25
Timer Recording	25
Timer Recording Errors	27
7 - VCR PLUS+	28
Channel Mapping	28
VCR Plus+ Worksheet	29
VCR Plus+ Recording	30
VCR Plus+ Timer Extend	32
8 - SEARCH/INDEX	33
About Index Marks	33
Index Search/Scan	34
Special Search Options	35



APPENDIX A - ADVANCED CONNECTIONS 36

S-Video/Component Hookup	36
Alt Video Out Setting	37
A/V Receiver/Stereo Hookup	38
Dolby/DTS Decoder Setting	39
Other A/V Hookup	40
Cable Box Hookup	41
Alternative Cable Box Hookup	42

APPENDIX B - SYSTEM SETTINGS 43

Language Settings	43
Auto Clock Settings	44
Manual Clock Settings	45
Daylight Savings Time	46
Channel Settings	47
Child Lock	48
Auto Play/Rewind	49
Front Panel Dimmer	50

APPENDIX C - ADVANCED DVD SETUP 51

TV Aspect Ratio	51
DVD Language Preferences	52
Dynamic Compression	53
Rating Control Settings	54
Changing Password	55
Changing Rating Level	56
Still Mode/Black Level	57

APPENDIX D - HELP 58

Troubleshooting	58
Technical Specifications	60
Warranty	61
Feature Summary	62

INDEX 63

IMPORTANT SAFETY INSTRUCTIONS

1. Read Instructions - All the safety and operating instructions should be read before the product is operated.
2. Retain Instructions - The safety and operating instructions should be retained for future reference.
3. Heed Warnings - All warnings on the product and in the operating instructions should be adhered to.
4. Follow Instructions - All operating and use instructions should be followed.
5. Cleaning - Unplug this product from the wall outlet before cleaning. Do not use liquid cleaners or aerosol cleaners. Use a damp cloth for cleaning.
6. Attachments - Do not use attachments not recommended by the product manufacturer as they may cause hazards.
7. Water and Moisture - Do not use this product near water - for example, near a bathtub, wash bowl, kitchen sink, or laundry tub; in a wet basement; or near a swimming pool; and the like.
8. Accessories - Do not place this product on an unstable cart, stand, tripod, bracket, or table. The product may fall, causing serious injury to a child or adult, and serious damage to the product. Use only with a cart, stand, tripod, bracket, or table recommended by the manufacturer, or sold with the product. Any mounting of the product should follow the manufacturer's instructions, and should use a mounting accessory recommended by the manufacturer.



9. A product and cart combination should be moved with care. Quick stops, excessive force, and uneven surfaces may cause the product and cart combination to overturn.

PORTABLE CART WARNING
(Symbol provided by RETAC)

10. Ventilation - Slots and openings in the cabinet are provided for ventilation and to ensure reliable operation of the product and to protect it from overheating, and these openings must not be blocked

or covered. The openings should never be blocked by placing the product on a bed, sofa, rug, or other similar surface. This product should not be placed in a built-in installation such as a bookcase or rack unless proper ventilation is provided or the manufacturer's instructions have been adhered to.

11. Power Sources - This product should be operated only from the type of power source indicated on the marking label. If you are not sure of the type of power supply to your home, consult your product dealer or local power company. For products intended to operate from battery power, or other sources, refer to the operating instructions.
12. Grounding or Polarization - This product may be equipped with a polarized alternating-current line plug (a plug having one blade wider than the other). This plug will fit into the power outlet only one way. This is a safety feature. If you are unable to insert the plug fully into the outlet, try reversing the plug. If the plug should still fail to fit, contact your electrician to replace your obsolete outlet. Do not defeat the safety purpose of the polarized plug.
13. Power-Cord Protection - Power-supply cords should be routed so that they are not likely to be walked on or pinched by items placed upon or against them, paying particular attention to cords at plugs, convenience receptacles, and the point where they exit from the product.
14. Protective Attachment Plug - The product is equipped with an attachment plug having overload protection. This is a safety feature. See Instruction Manual for replacement or resetting of protective device. If replacement of the plug is required, be sure the service technician has used a replacement plug specified by the manufacturer that has the same overload protection as the original plug.
15. Outdoor Antenna Grounding - If an outside antenna or cable system is connected to the product, be sure the antenna or cable system is grounded so as to provide some protection against voltage surges and built-up static charges. Article 810 of the National Electrical Code, ANSI/NFPA 70, provides information with re-



gard to proper grounding of the mast and supporting structure, grounding of the lead-in wire to an antenna discharge unit, size of grounding conductors, location of antenna-discharge unit, connection to grounding electrodes, and requirements for the grounding electrode. See figure below:

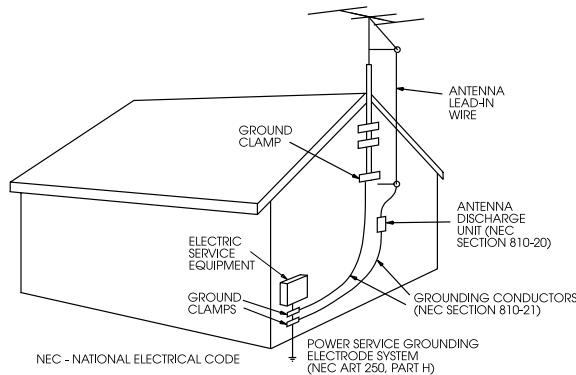

16. Lightning - For added protection for this product during a lightning storm, or when it is left unattended and unused for long periods of time, unplug it from the wall outlet and disconnect the antenna or cable system. This will prevent damage to the product due to lightning and power lines surges.
17. Power Lines - An outside antenna system should not be located in the vicinity of overhead power lines or other electric light or power circuits, or where it can fall into such power lines or circuits. When installing an outside antenna system, extreme care should be taken to keep from touching such power lines or circuits as contact with them might be fatal.
18. Overloading - Do not overload wall outlets, extension cords, or integral convenience receptacles as this can result in a risk of fire or electric shock.
19. Object and Liquid Entry - Never push objects of any kind into this product through openings as they may touch dangerous voltage points or short-out parts that could result in a fire or electric shock. Never spill liquid of any kind on the product.
20. Servicing - Do not attempt to service this product yourself as opening or removing covers may expose you to dangerous voltage or other hazards. Refer all servicing to qualified service personnel.
21. Damage Requiring Service - Unplug this product from the wall outlet and refer servicing to qualified service personnel under the following conditions:
 - a) When the power-supply cord or plug is damaged,
 - b) If liquid has been spilled, or objects have fallen into the product,
 - c) If the product has been exposed to rain or water,
 - d) If the product does not operate normally by following the operating instructions. Adjust only those controls that are covered by the operating instructions as an improper adjustment of other controls may result in damage and will often require extensive work by a qualified technician to restore the product to its normal operation,
 - e) If the product has been dropped or damaged in any way, and
 - f) When the product exhibits a distinct change in performance - this indicates a need for service.
22. Replacement Parts - When replacement parts are required, be sure the service technician has used replacement parts specified by the manufacturer or have the same characteristics as the original part. Unauthorized substitutions may result in fire, electric shock, or other hazards.
23. Safety Check - Upon completion of any service or repairs to this product, ask the service technician to perform safety checks to determine that the product is in proper operating condition.
24. Wall or Ceiling Mounting - The product should be mounted to a wall or ceiling only as recommended by the manufacturer.
25. Heat - The product should be situated away from heat sources such as radiators, heat registers, stoves, or other products (including amplifiers) that produce heat.

1

GETTING STARTED

This Chapter will guide you through initial setup of your DVD+VCR, including basic connections and Auto Setup.

Before you begin, please check that all items are included in your DVD+VCR box, then insert the enclosed batteries in the remote control.

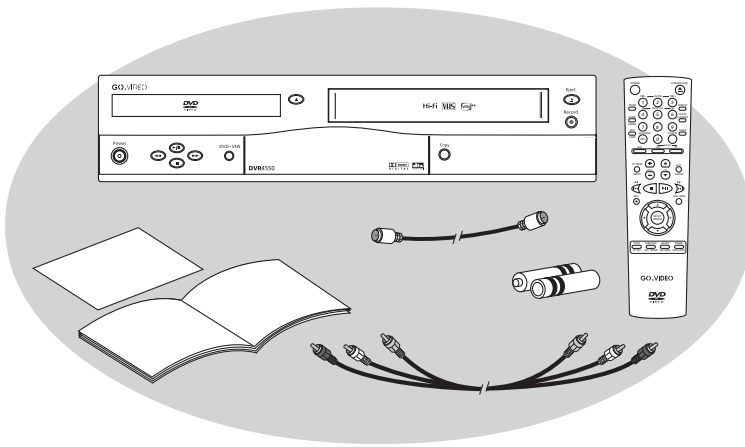

1 UNPACK YOUR DVD+VCR

As you unpack, please check that the following items are included in your DVD+VCR packing case:

- DVD+VCR
- Warranty Registration Card
- User's Guide
- Stereo A/V Cable
- RF Coaxial Cable
- Remote Control
- 1.5V "AA" Batteries (2)

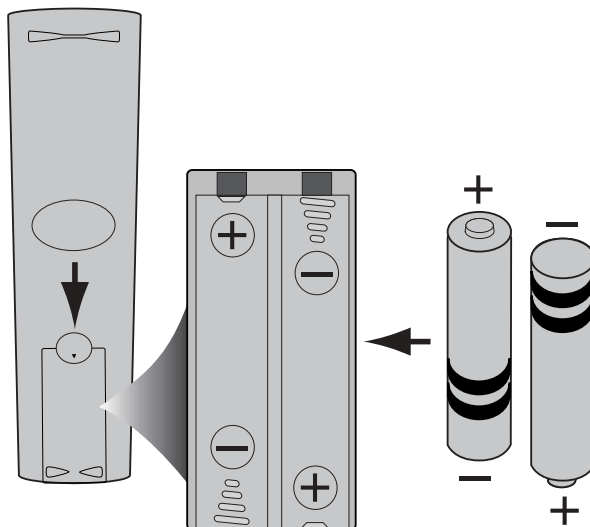

2 INSERT BATTERIES

- Remove the battery cover by pushing down on the thumb tab and sliding the cover in the direction of the arrow.
- Insert two 1.5V "AA" batteries as shown, paying attention to the correct polarities (+/-).
- When finished, slide the cover until it clicks back into place.



Follow these steps to connect the DVD+VCR to your television and antenna/cable TV.

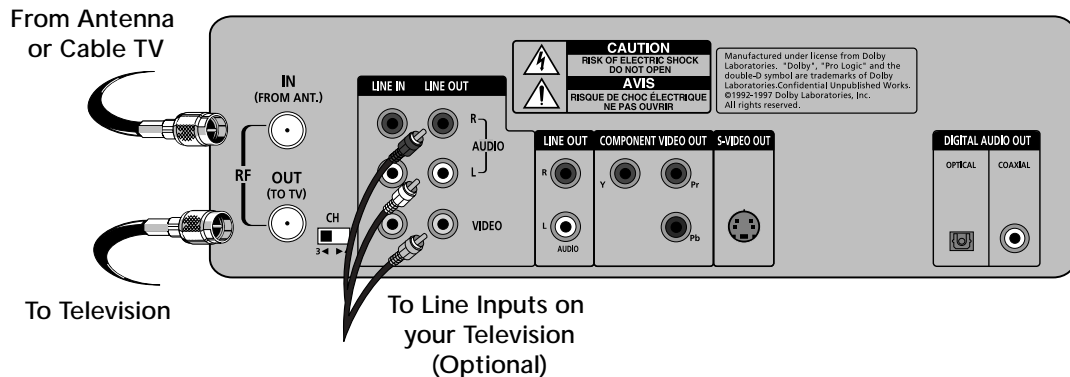

- 1 **CONNECT ANTENNA/CABLE TV**
Connect the RF coaxial cable from your indoor/outdoor antenna or cable wall outlet to the IN (FROM ANT.) jack on the back panel of the DVD+VCR.
- 2 **CONNECT DVD+VCR TO TV**
RF Connection
Connect the supplied RF coaxial cable from the "OUT (TO TV)" jack on the DVD+VCR back panel to your television's antenna in jack. Use this connection if your television is equipped with a basic antenna input.

OR
Line Connection
Connect the supplied stereo A/V cable from the "Line Out" jacks on the DVD+VCR back panel to your television's Line In jacks. Be sure to match yellow to video, red to right audio and white to left audio on your television and DVD+VCR. Use this connection for better sound and picture quality if your television is equipped with line inputs.
- 3 **SET DVD+VCR OUTPUT CHANNEL**
If you used the RF connection in Step 2, set the CH (Channel) switch on the back panel of the DVD+VCR to 3 or 4, whichever is not an active channel in your area. If you used the Line Connection, skip to Step 4.
- 4 **PLUG IN DVD+VCR**
Connect the DVD+VCR power cord to a standard 120V/60Hz wall outlet.
- 5 **TURN ON TV AND DVD+VCR**
Turn on your television, and press POWER on your DVD+VCR.
- 6 **SET TV TO CHANNEL 3, 4, OR LINE**
Set your TV to the same channel you selected in Step 3. If you used the Line Connection, set your TV to its Line input.
 - The "Language/Langue/Idioma" menu should appear on the screen.
 - Please proceed with Auto Setup on the following page.

NOTES

- For Advanced Connections, please refer to Appendix A.
- Even if you plan to use the S-Video or Component Video Outputs you MUST connect the DVD+VCR to your television with either the RF or Line Connection. This will enable you to operate the DVD+VCR setup menus.

Follow these steps to run Auto Setup, which will set the clock and search for local channels automatically.

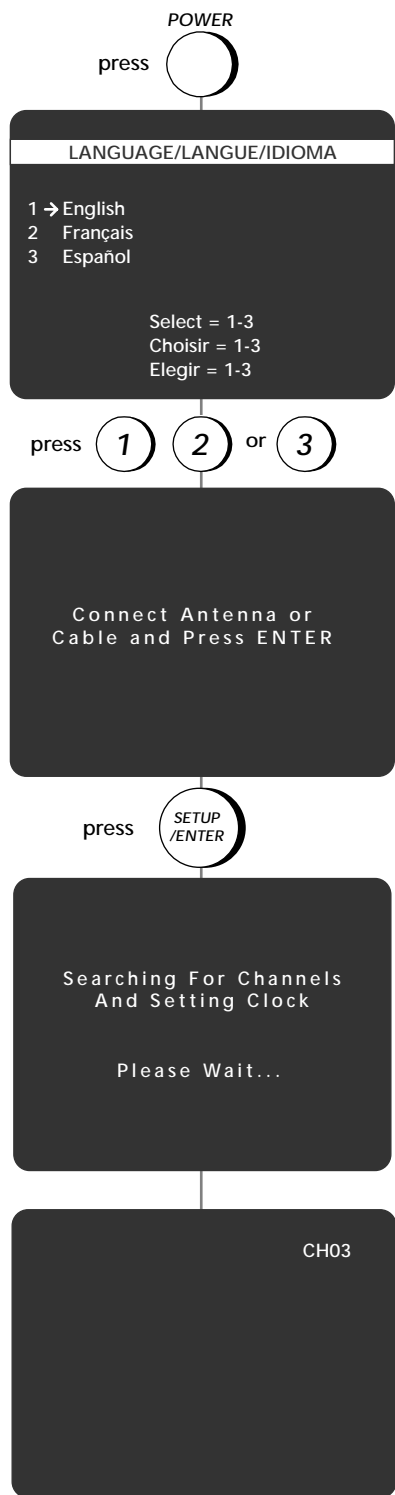

1 SET MENU LANGUAGE

The first time you turn on your DVD+VCR, you will be prompted to set the menu language. Press 1 for English, 2 for French or 3 for Spanish.

2 CONFIRM ANTENNA/CABLE CONNECTION

If you have not already done so, make sure you have connected an antenna or basic cable to the "IN (FROM ANT.)" jack on the DVD+VCR back panel. Press SETUP/ENTER to continue.

3 RUN AUTO SETUP

As soon as you press SETUP/ENTER, the DVD+VCR will automatically perform the following steps:

Auto Channel Search – Automatically detects whether an antenna or cable is connected, then searches for all active channels in your area. If Auto Channel Search is unable to locate channels in your area, you can search and add channels manually; see page 47.

Auto Clock Set – Sets the DVD+VCR's internal clock. If Auto Clock Set is unable to find a channel to set the clock, you can set the clock manually; see pages 45-46.

- This procedure may take a few minutes to complete. When finished, the DVD+VCR will display the lowest channel found.
- If you wish, you can now program your remote control to control your television; see page 4. Or you can proceed with Chapter 2 for a Quick Tour of the DVD+VCR system.

NOTES

- If no channels were found in your area, the DVD+VCR will alert you and then display the "Channel Setup" menu; see page 47.
- If Auto Setup was unable to detect the time, the DVD+VCR will alert you and then display the "Set Month" menu; see page 45.



Follow these steps to program the remote control to operate many brands of television.

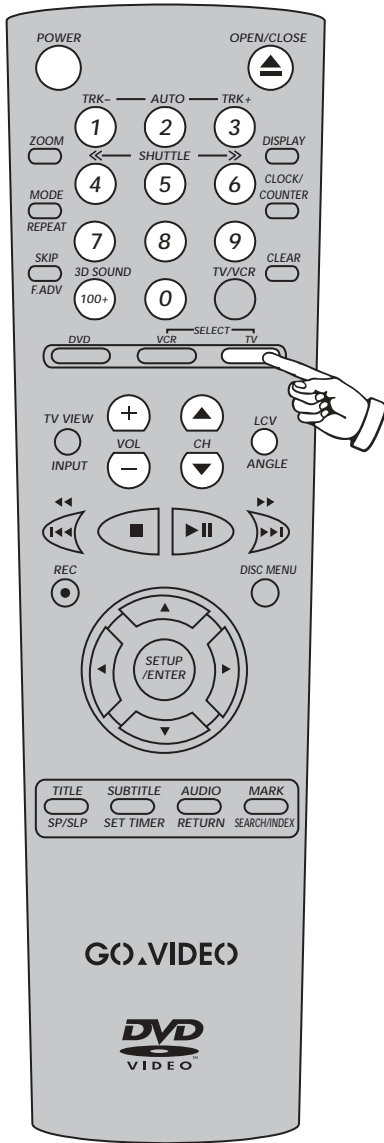

Pressing the TV key puts the remote control in TV mode. Some or all of the highlighted keys will be able to control your television.

1 TURN ON TELEVISION

Press POWER on your television.

2 ENTER CODE

Press and hold the TV key on the DVD+VCR remote control while entering the 2-digit code for your brand of television with the 0-9 keys (see table below). If there is more than one code for your brand of television, try them all until one works.

BRAND	CODE(S)
Daewoo	TV + 19
Emerson	TV + 21
Hitachi	TV + 10
JVC	TV + 11
LG (Goldstar)	TV + 06, 08, 18
Loewe	TV + 28
Magnavox	TV + 04
Mitsubishi	TV + 13
Newsan (S. America)	TV + 27
Noblex (S.America)	TV + 25
Panasonic	TV + 12, 24
RCA	TV + 07, 29
Samsung	TV + 01, 14, 15, 23
Sanyo	TV + 05, 20
Sharp	TV + 02, 16, 22
Sony	TV + 03
Telefunken	TV + 26
Toshiba	TV + 09
Zenith	TV + 17

3 CHECK YOUR RESULTS

If the television advances to the next active channel, programming is complete! If the television does not respond, try another 2-digit code. Some televisions are not listed but can be programmed.

4 OPERATE YOUR TELEVISION

When you want to control your television, press the TV key, then try any of the keys shown in the drawing at left.

- When the remote control is in TV mode, it WILL NOT operate your DVD+VCR.
- To restore DVD+VCR control, press the DVD or VCR key.

NOTE

- When the remote is in TV mode, it WILL NOT operate the DVD+VCR. Press DVD or VCR to restore normal DVD+VCR functionality.

2

QUICK TOUR

This Chapter provides an overview of the DVD+VCR remote control, front panel, front panel display and rear panel.

The following is an overview of the DVD+VCR remote control. The keys are described in four sections: System/Deck Select Keys, TV Control Keys, DVD Control Keys, and VCR Control Keys.

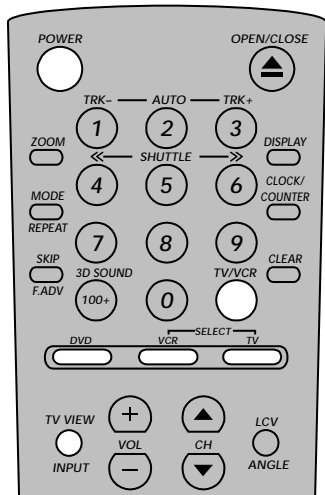

The System/Deck Select keys control the DVD+VCR system as a whole.

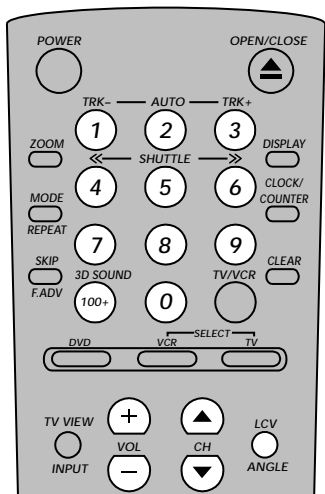

The TV Control keys operate the DVD+VCR's built-in television tuner.

SYSTEM/DECK SELECT KEYS

POWER

Press to power the DVD+VCR on and off.

DVD

Press to set the remote control to operate the DVD deck.

VCR

Press to set the remote control to operate the VCR deck.

TV

Press to set the remote control to operate your TV (optional); see page 4.

TV/VCR

Press to switch back and forth between the TV tuner and the DVD+VCR's internal tuner. This key has no effect if you connected the DVD+VCR to your TV with the Line connection; it is only applicable with the RF connection.

TV VIEW

Press to change the view on your television among all the DVD+VCR input sources: DVD, VCR, Tuner, Line 1, and Line 2.

TV CONTROL KEYS

0-9

Press to select channels directly.

100+

Press to select cable channels 100 and above.

LCV

Press to display the last channel viewed.

CH ▲▼

Press to select the next or previous channel.

VOLUME +/-

Press to adjust the volume up or down.

The DVD Control keys are active when the DVD deck is selected (by pressing the DVD key on the remote control or the DVD+VCR key on the front panel).

OPEN/CLOSE

Press to open and close the DVD disc drawer.

0-9

Press to select specific disc menu items.

ANGLE

While a DVD is playing, press to view the same scene from different angles (not available on all DVDs).

ZOOM

While a DVD is playing, press to zoom in at 2 or 4 times the normal magnification.

3D SOUND

While a DVD is playing, press to create the illusion of surround sound with only 2 speakers.

SKIP/SEARCH BACK ◀◀

While a DVD is playing, press once to return to the previous track. Press and hold to search in reverse.

STOP ■

Press to stop the DVD from playing.

PLAY/PAUSE ▶▶

Press to play a DVD. Press again to pause playback.

SKIP/SEARCH FORWARD ▶▶

While a DVD is playing, press once to advance to the next track. Press and hold to search forward.

DISC MENU

Press to access a DVD's disc menu (if available).

DISPLAY

While a DVD is playing, press to turn on the Title/Chapter/Time menu.

MODE/REPEAT

While a DVD or CD is stopped, press to select "Random Play" or "Programmed Play." While a DVD or CD is playing, press to view all Repeat Options (Title, Chapter, or A/B Repeat).

SKIP/F.ADV

While a DVD is paused, press to advance one frame at a time.

CLOCK/COUNTER

Press to display the current DVD counter value.

SETUP/ENTER

Press to bring up the DVD+VCR menu system. Also confirms settings in certain menus.

ARROW KEYS

Used to navigate up, down, left and right in menus.

TITLE

Press to access a DVD's title menu (for discs with multiple titles only).

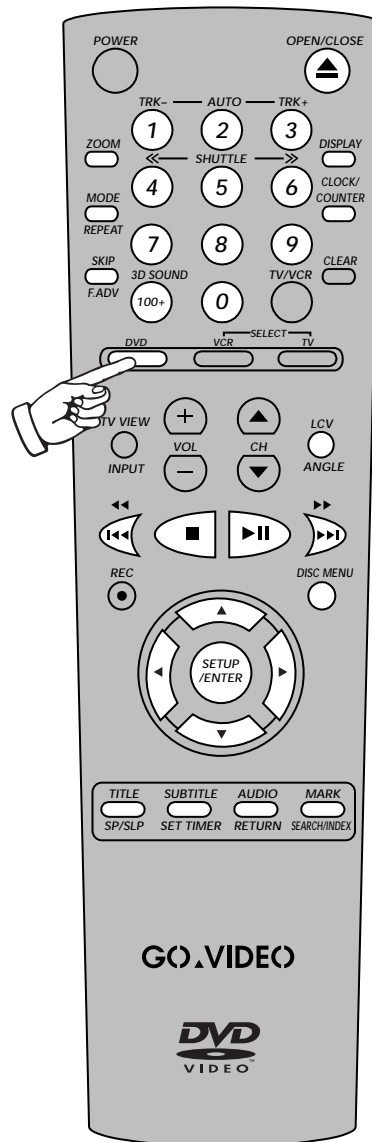

SUBTITLE

While a DVD is playing, press to select among all available subtitle languages.

AUDIO

While a DVD is playing, press to select among all available audio tracks/formats.

RETURN

When in the menu system, press to return to the last menu viewed or to exit the menu system.

MARK

While a DVD is playing, press to bookmark up to 3 scenes, which you can quickly jump to later.

The VCR Control keys are active when the VCR deck is selected (by pressing the VCR key on the remote control or the DVD+VCR key on the front panel).

OPEN/CLOSE

Press to eject the VHS tape from the VCR deck.

TRK-/AUTO/TRK+

While a tape is playing, press to adjust tracking (white lines on the screen). Press AUTO to resume automatic tracking.

SHUTTLE << >>

While a tape is playing, press SHUTTLE >> to gradually increase the cue speed (visual search forward). Press << SHUTTLE to slow down the tape, pause, then gradually increase the review speed (visual search in reverse).

REWIND ◀◀

While a tape is stopped, press to rewind the tape. While a tape is playing, press to review the tape (visual search in reverse).

STOP ■

Press to stop the tape in the VCR deck.

PLAY/PAUSE ▶◥

Press once to play the tape in the VCR deck. While a tape is playing or recording, press to pause.

FAST-FORWARD ▶▶

While a tape is stopped, press to fast-forward the tape. While a tape is playing, press to cue the tape (visual search forward).

REC ●

Press to start recording in the VCR deck. Press repeatedly to add recording time in 30-minute increments.

CLEAR

Press to reset the tape counter to zero (0:00:00). Also press to clear certain entries in the menu system.

DISPLAY

Press to turn on the VCR's On-Screen Display.

MODE/REPEAT

While a tape is playing, press to replay the last 30 seconds.

SKIP/F.ADV

While a tape is playing, press 1-5 times to skip ahead 1 minute at a time (up to 5 minutes).

While a tape is paused, press to advance one frame at a time.

CLOCK/COUNTER

Press to change the front panel display among the clock, tape counter, and time remaining on your tape.

SETUP/ENTER

Press to bring up the DVD+VCR menu system. Also confirms settings in certain menus.

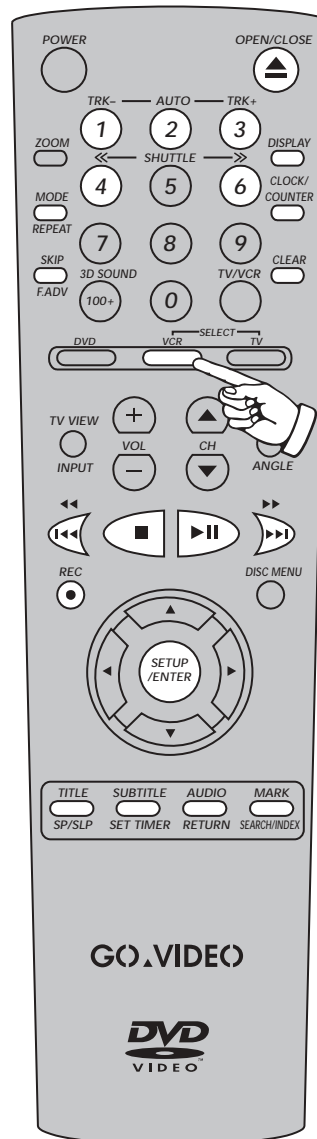

SP/SLP

Press to set the record speed to SP (Standard Play) or SLP (Super Long Play). SLP is three times longer than SP.

VCR PLUS+

Press to program a VCR Plus+ recording.

AUDIO

Press to set the VCR tuner audio to Stereo, Mono, SAP (Second Audio Program), or TV+SAP (mono from the left channel and SAP from the left), depending on availability.

SEARCH/INDEX

While a tape is stopped, playing, fast-forwarding or rewinding, press to display the "Search" Menu. While a tape is recording, press to place Index marks on the tape.

The following is an overview of the DVD+VCR front panel.

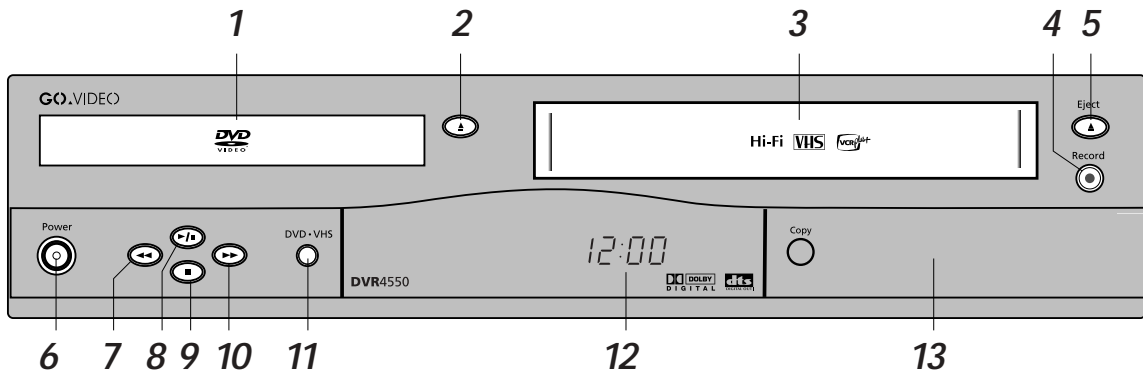

1 DVD DECK

Deck used for DVD/CD playback and other DVD functions.

2 DVD OPEN/CLOSE

Press to open and close the DVD disc drawer.

3 VCR DECK

Deck used for VCR playback and other VCR functions.

4 RECORD ●

Press to start recording in the VCR deck. Press repeatedly to add recording time in 30-minute increments (see page 22).

5 VCR EJECT

Press to eject the VHS tape from the VCR deck.

6 POWER

Press to power the DVD+VCR on and off.

7 DVD - SKIP/SEARCH BACK ◀◀

While a DVD is playing, press once to return to the previous track. Press and hold to search in reverse.

VCR - REWIND ◀◀

While a VHS tape is stopped, press to rewind the tape. While a tape is playing, press to review the tape (visual search in reverse).

8 PLAY/PAUSE ▶▶

Press to start playback in the active deck. Press again to pause playback. Also used to pause recording in the VCR deck.

9 STOP ■

Press to stop playback in the active deck.

10 DVD - SKIP/SEARCH FORWARD ▶▶▶

While a DVD is playing, press once to advance to the next track. Press and hold to search forward.

VCR - FAST-FORWARD ▶▶▶

While a VHS tape is stopped, press to fast-forward the tape. While a tape is playing, press to cue the tape (visual search forward).

11 DVD-VHS SELECT

Press to toggle control between the DVD deck and the VCR deck.

12 FRONT PANEL DISPLAY

Displays information pertaining to DVD+VCR operation.

13 FLAP DOOR

The front panel flap door opens to reveal additional keys, as well as the front line audio/video inputs (see next page).

The following is an overview of the keys and inputs located behind the front panel flap door.

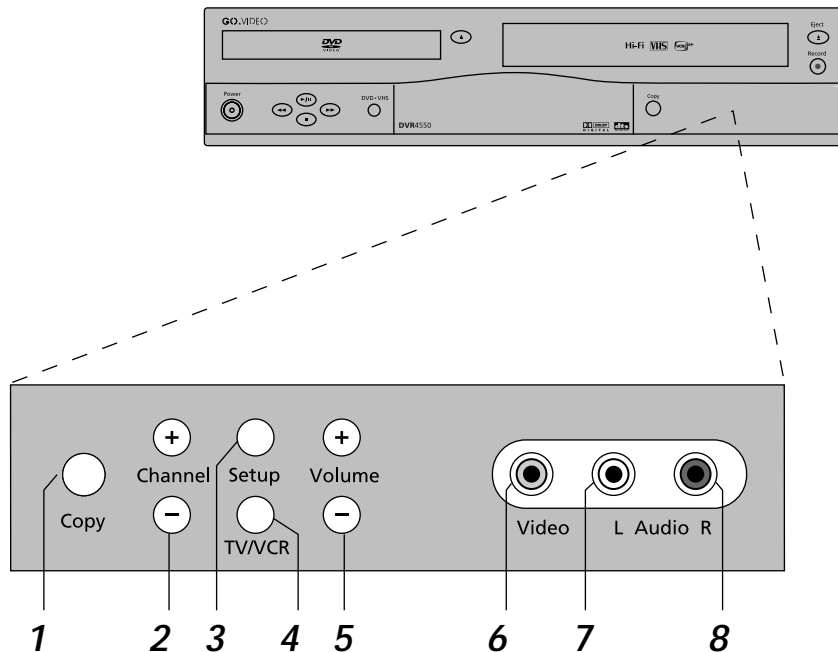

1 COPY

Press to copy a DVD in the DVD deck to a VHS tape in the VCR deck. Note: The DVD+VCR will not copy Macrovision® encoded DVDs.

2 CHANNEL +/-

Press to select the next or previous channel.

3 SETUP

Press to display the DVD+VCR "Setup Menu."

4 TV/VCR

Press to switch back and forth between your television's tuner and the DVD+VCR's internal tuner. This key has no effect if you connected the DVD+VCR to your television with the Line connection; it is only applicable with the RF connection (see page 2).

5 VOLUME +/-

Press to adjust the volume up or down.

6 LINE 1 VIDEO INPUT

Connect to the video output (yellow) of an external video source, such as a camcorder or video game.

7 LINE 1 LEFT AUDIO INPUT

Connect to the left audio output (white) of an external audio source. Use this jack when connecting mono sources.

8 LINE 1 RIGHT AUDIO INPUT

Connect to the right audio output (red) of an external audio source.

The following is an overview of the DVD+VCR front panel display.

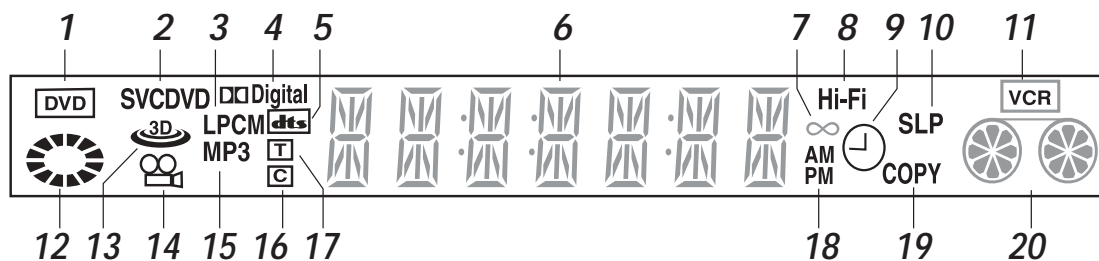

When the specified indicator is lit on the front panel display, it means that:

- | | |
|---|---|
| <p>1 DVD DECK INDICATOR
The DVD deck is active.</p> <p>2 DISC TYPE INDICATOR
A DVD, CD, VCD or SVCD is loaded.</p> <p>3 LPCM INDICATOR
A disc with LPCM (Linear Pulse Code Modulation), such as an audio CD, is loaded.</p> <p>4 DOLBY DIGITAL INDICATOR
A DVD with a Dolby Digital 5.1 soundtrack is loaded.</p> <p>5 DTS INDICATOR
A DVD with a DTS (Digital Theater Sound) 5.1 soundtrack is loaded.</p> <p>6 DECK STATUS INDICATOR
The time, counter position, time remaining, or current deck status is displayed.</p> <p>7 STEREO INDICATOR
The current television program is being broadcast in stereo sound.</p> <p>8 HI-FI INDICATOR
The Hi-Fi track of a VHS tape is playing.</p> <p>9 TIMER RECORD INDICATOR
A timer recording is programmed or in progress. If blinking there is an error. Also displays without the clock hands to indicate that a recording is in progress, and blinks when the DVD+VCR is paused.</p> <p>10 RECORD SPEED INDICATOR
The DVD+VCR record speed is set to SP or SLP.</p> | <p>11 VCR DECK INDICATOR
The VCR deck is active.</p> <p>12 DVD STATUS INDICATOR
The status of the DVD deck is graphically displayed.</p> <p>13 3D SOUND INDICATOR
3D Sound is active.</p> <p>14 ANGLE INDICATOR
The DVD has multiple angles to choose from.</p> <p>15 MP3 INDICATOR
A CD with MP3 audio tracks is loaded.</p> <p>16 CHAPTER INDICATOR
The number to the right of the "C" symbol is the current chapter number.</p> <p>17 TITLE INDICATOR
The number to the right of the "T" symbol is the current title number.</p> <p>18 AM/PM INDICATOR
The current time is a.m. or p.m.</p> <p>19 COPY INDICATOR
DVD to VHS copy is in progress.</p> <p>20 VCR STATUS INDICATOR
The status of the VCR deck is graphically displayed.</p> |
|---|---|

The following is an overview of the DVD+VCR rear panel.

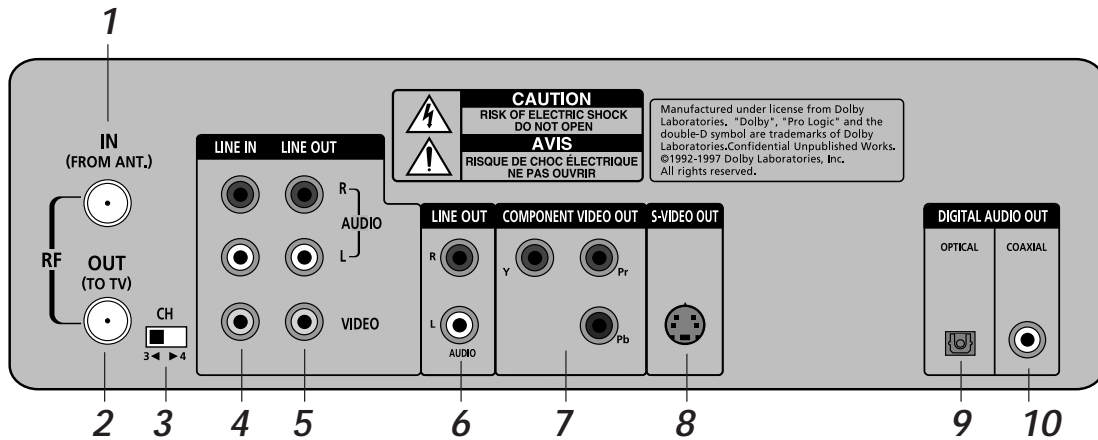

1 RF ANTENNA INPUT

Connect to your antenna, cable TV, or cable box with an RF coaxial cable.

2 RF OUT TO TV

Connect to your television with an RF coaxial cable.

3 VCR TUNER CHANNEL SWITCH

Set to channel 3 or 4 (whichever channel your television is tuned to).

4 LINE 2 INPUT

Connect from the outputs of an external audio/video device.

5 LINE OUT TO TV (COMPOSITE)

Connect to your television with standard RCA cables. Use these audio outputs ONLY with the composite video output (yellow).

6 LINE OUT TO TV (S-VIDEO OR COMPONENT)

Connect to your television with standard RCA cables. Use these audio outputs ONLY with the Component or S-Video outputs.

7 COMPONENT VIDEO OUT

Connect to your television with component video cables (Y, Pb, Pr). For audio, use the Line Out or Digital Audio Out (optical or coaxial).

8 S-VIDEO OUT

Connect to your television with an S-Video cable. For audio, use the Line Out or Digital Audio Out (optical or coaxial).

9 DIGITAL AUDIO OUT (OPTICAL)

Connect to your AV receiver with a digital optical cable.

10 DIGITAL AUDIO OUT (COAXIAL)

Connect to your AV receiver with a digital coaxial cable.

BASIC OPERATIONS

This Chapter shows you how to play DVDs and videotapes with your DVD+VCR.
You will also learn how to navigate in the DVD+VCR menu system.

Follow these steps to play a DVD.

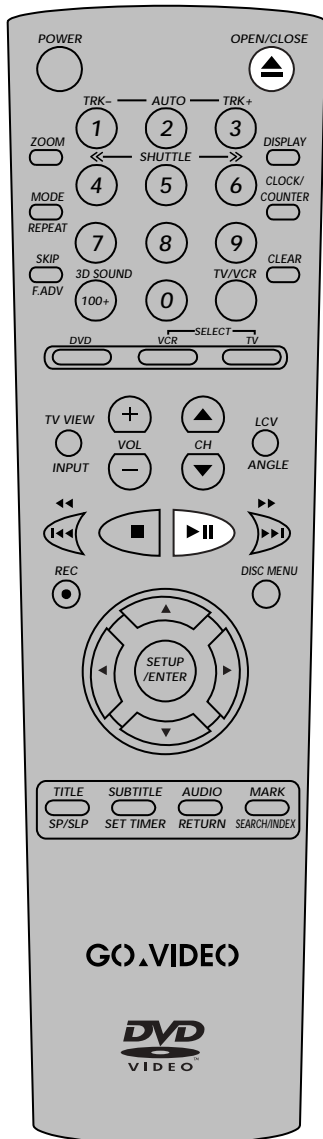

1 OPEN DISC DRAWER

Press OPEN/CLOSE to automatically power on the DVD+VCR and open the disc drawer.

2 INSERT DISC

Place the disc in the drawer with the label side facing up. If the disc has two sides, orient the disc with the desired label facing up.

3 CLOSE DISC DRAWER

Press OPEN/CLOSE again to close the disc drawer.

4 PLAY THE DVD

Press PLAY/PAUSE ►||.

- Many discs will begin playback automatically when the disc drawer closes.
- If the DVD has a disc menu, or more than one title, the disc menu may appear. If so, use the UP/DOWN/LEFT/RIGHT arrow keys to highlight choices, then press SETUP/ENTER to make selections.

5 ADDITIONAL DVD OPTIONS

- To freeze playback, press PLAY/PAUSE ►||. To advance one frame at a time, press SKIP/F.ADV. To resume playback, press PLAY/PAUSE ►|| again.
- To skip to the next or previous chapter/track, press SKIP FORWARD ►►| or SKIP BACK |◄◄.
- To search forward or backward at variable speeds, press and hold SEARCH FORWARD ►►| or SEARCH BACK |◄◄.
- To play in slow motion at variable speeds, first press PLAY/PAUSE ►||, then press SEARCH FORWARD ►►|. Each press will increase the rate of slow motion playback.
- To stop playback, press STOP ■ once. To resume playback from the same place in the movie/CD, press PLAY/PAUSE ►||. To stop playback completely and restart the disc, press STOP ■ twice.
- For special DVD features, see Chapter 4.
- For advanced DVD setup, see Appendix C.

NOTE

- If the player is left in Freeze mode for 2 minutes, it will stop automatically.

Follow these steps to play a VHS tape.

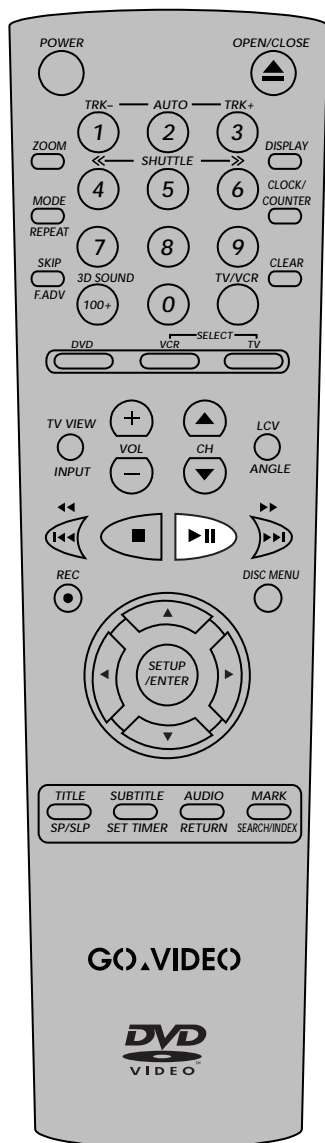

1 INSERT VHS TAPE

Insert a standard VHS videotape into the VCR deck. The DVD+VCR will power on automatically when you insert the tape.

2 PLAY TAPE

Press PLAY/PAUSE ►||.

- If the tape is missing the Record Safety Tab and Auto Play is turned on, the tape will begin playing automatically, see page 49.

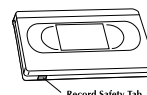

3 ADDITIONAL VCR OPTIONS

- To freeze playback, press PLAY/PAUSE ►||. To advance one frame at a time, press SKIP/F.ADV. To resume playback, press PLAY/PAUSE ►|| again.
- To visually search forward and backward at 5 times normal speed, press F.FORWARD ►► or REWIND ◀◀.
- To visually search forward and backward at 7 times normal speed, press and hold F.FORWARD ►► or REWIND ◀◀.
- To cue ahead one minute at a time up to 5 minutes, press SKIP/F.ADV 1-5 times.
- To replay the last 30 seconds of tape, press MODE/REPEAT.
- To gradually increase the cue speed, press SHUTTLE >> repeatedly. To slow down the tape, pause, then gradually increase the review speed, press << SHUTTLE repeatedly.
- To adjust tracking manually, press TRK +/- . To resume automatic tracking, press AUTO.
- For VCR recording features, see page 22.
- For Timer Recording, see page 25.

NOTE

- Tapes without Record Safety Tabs are set to play automatically when inserted. To disable this feature, see page 49.

The following keys are used to open and navigate through the DVD+VCR on-screen menu system.

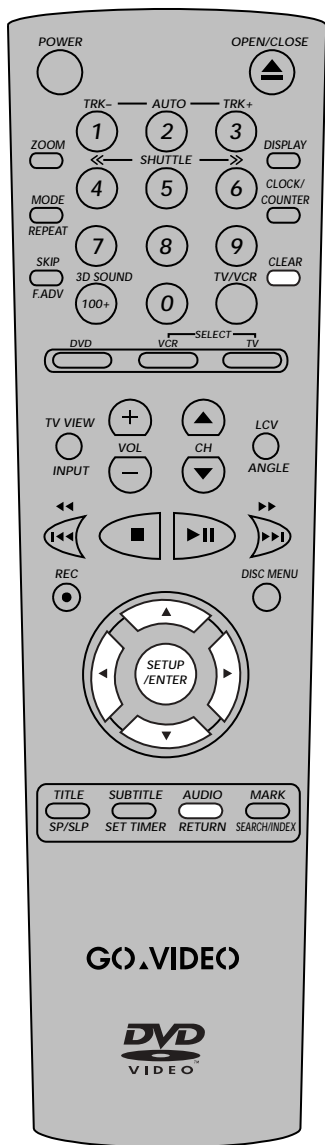

SETUP/ENTER KEY

Press to access the DVD+VCR on-screen menu system.



UP ARROW KEY

Moves pointer up the list of menu items.



DOWN ARROW KEY

Moves pointer down the list of menu items.



RIGHT ARROW KEY

Selects or changes menu options.



LEFT ARROW KEY

Moves backward through menu options in certain screens.



CLEAR KEY

Clears options in certain menus.



RETURN KEY

Moves backward or exits certain menus.

FRONT PANEL MENU KEYS

The following front panel keys can also be used to control the menu system:

- **Setup** (behind flap door) = SETUP/ENTER key
- **Play/Pause** = UP arrow key
- **Stop** = DOWN arrow key
- **Rewind** = LEFT arrow key
- **Fast-Forward** = RIGHT arrow key

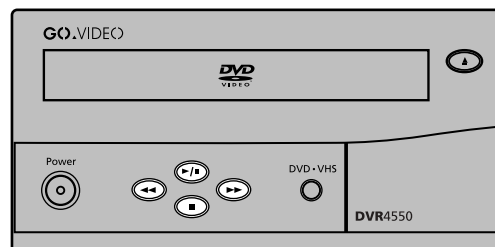

NOTE

- Some menus are not available while a DVD is playing or while the VCR deck is recording.

4

SPECIAL DVD FEATURES

This Chapter explains some of the special features of DVD/CD/VCD playback.

The DISPLAY button is a shortcut to view and select the desired title/track, chapter or time (counter position).

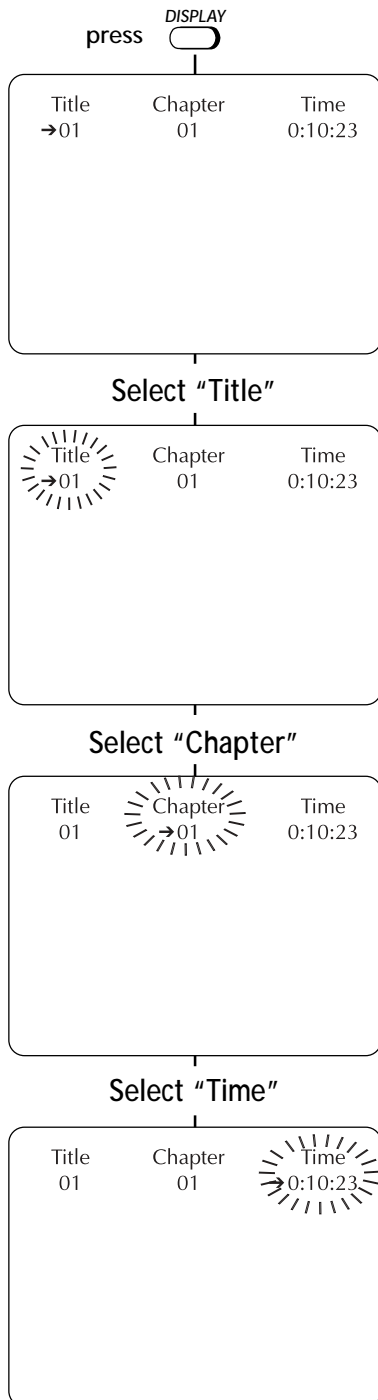

1 VIEW DVD/CD DISPLAY

Press DISPLAY during DVD/CD playback.

2 SELECT TITLE, CHAPTER OR TIME

Title or Track

Use the LEFT/RIGHT arrow keys to select "Title" or "Track" then use the UP/DOWN arrow keys to select from all available titles/tracks on the disc.

Press SETUP/ENTER to jump to the desired title/track.

The "T" icon will light on the front panel display, followed by the current title/track number.

Chapter

Use the LEFT/RIGHT arrow keys to select "Chapter," then use the UP/DOWN arrow keys to select from all available chapters on the disc.

Press SETUP/ENTER to jump to the desired chapter.

The "C" icon will light on the front panel display, followed by the current chapter number.

Time

Use the LEFT/RIGHT arrow keys to select "Time," then use the number keys (0-9) to enter the desired counter position in hours, minutes and seconds.

Press SETUP/ENTER to jump to the desired counter position.

The counter position will light on the front panel display in hours, minutes and seconds.

3 CLEAR DISPLAY

Press the RETURN key to clear the display.



Follow these instructions to view a DVD movie from multiple angles, or to zoom in during playback.

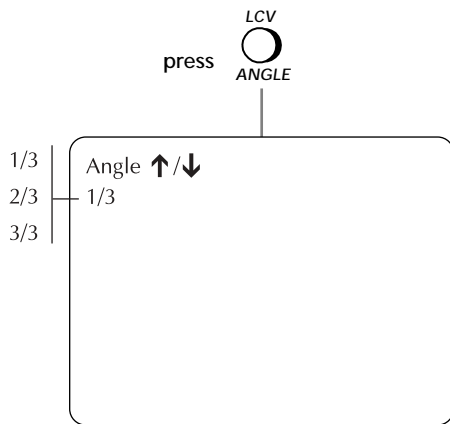

ANGLE 

Some DVDs allow you to view the same scene from different perspectives, or angles, while watching a movie. Press ANGLE during DVD playback to activate this feature.

- 1 If multiple Angles are available on the DVD, the Angle mark will appear on the front panel display during playback.
- 2 Press ANGLE to view the Angle Selection menu.
- 3 Use the UP/DOWN arrow keys to select one of the available screen angles.

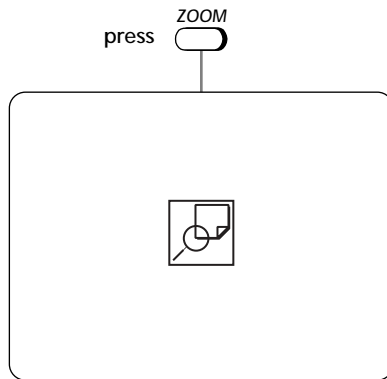

ZOOM 

With the Zoom feature, you can zoom in at 2 or 4 times normal magnification while watching a DVD.

- 1 While a DVD is playing or paused, press ZOOM to display the magnifying glass icon on the screen.
- 2 Use the arrow keys to move the magnifying glass to any position on the screen you want to zoom.
- 3 Press SETUP/ENTER repeatedly to zoom in at 2X, 4X, 2X, and then back to normal magnification.

NOTE

- The Angle and Zoom features are not available during VCD playback.

Follow these steps to select among all available subtitle languages and audio tracks on your DVD, or to activate 3D Sound.

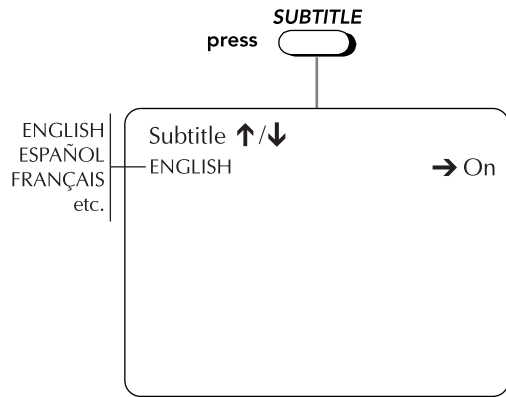

SUBTITLES

Many DVDs provide subtitles in one or more languages. The SUBTITLE key provides a shortcut to view and select from all available subtitle languages on the disc.

- 1 While playing a DVD, press SUBTITLE.
- 2 Use the UP/DOWN arrow keys to select from the available subtitle languages.
- 3 Use the LEFT/RIGHT arrow keys to turn the selected subtitle language on or off.
- 4 Press SETUP/ENTER to confirm your selection.

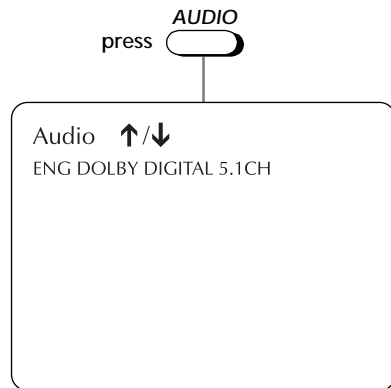

AUDIO

Many DVDs provide multiple language and audio setup options, such as Dolby Digital 5.1, Dolby Pro Logic, or LPCM 2 Channel audio. The AUDIO key provides a shortcut to view and select among all available options for a given disc.

- 1 While playing a DVD, press AUDIO.
- 2 Use the UP/DOWN arrow keys to select from all available audio languages/audio formats on the DVD.
- 3 Press SETUP/ENTER to confirm your selection.

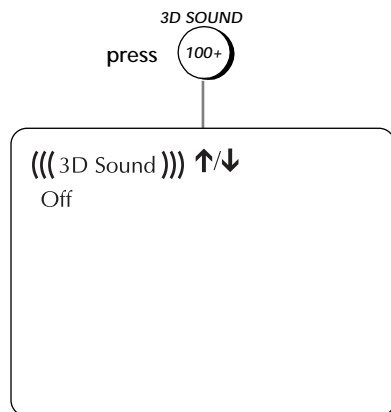

3D SOUND

3D Audio is an enhanced audio mode that creates the illusion of Surround Sound with only two speakers.

- 1 While playing a DVD, press 3D SOUND.
- 2 Use the UP/DOWN arrow keys to turn 3D Sound "On" or "Off."
- 3 Press 3D SOUND again to confirm your selection.

Follow these steps to repeat a chapter, title, or segment (A-B Repeat) of a DVD or CD.

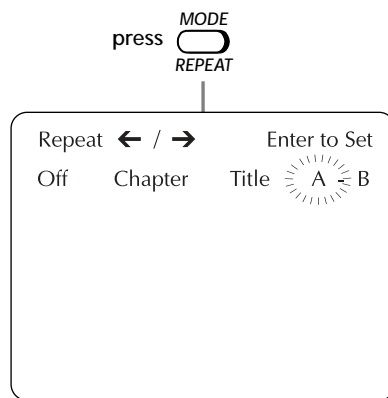
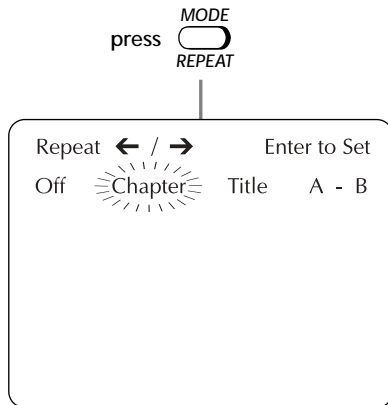

REPEAT CHAPTER/TITLE

You can repeat a single chapter or track over and over, or you can repeat a complete title of a DVD.

- 1 While playing a DVD or CD, press **MODE/REPEAT**. On the Repeat menu, the current Repeat Mode will blink.
- 2 Use the **LEFT/RIGHT** arrow keys to select Chapter/Track or Title.
- 3 Press **SETUP/ENTER** to repeat the current chapter/track or title.

A-B REPEAT

The A-B Repeat function allows you to repeat any segment of a DVD or CD over and over again. Simply mark the beginning point (A) and the ending point (B) of the segment you want to review.

- 1 While playing a DVD or CD, press **MODE/REPEAT**.
- 2 Use the **LEFT/RIGHT** arrow keys to select A-B. The "A" will blink when A-B Repeat is selected.
- 3 Press **SETUP/ENTER** at the beginning of the desired segment to set Point A. The "B" will blink after Point A is selected.
- 4 Press **SETUP/ENTER** again at the end of the desired segment to set Point B. The segment will repeat in a continuous loop.
- 5 To resume normal playback, press the **MODE/REPEAT** button to open the "Repeat Menu." Use the **LEFT/RIGHT** arrow keys to highlight "Off," then press **SETUP/ENTER**.

NOTE

- The minimum A-B Repeat time is 5 seconds.

You can insert up to three Bookmarks on your DVDs, so you can jump quickly to your favorite scene or song.

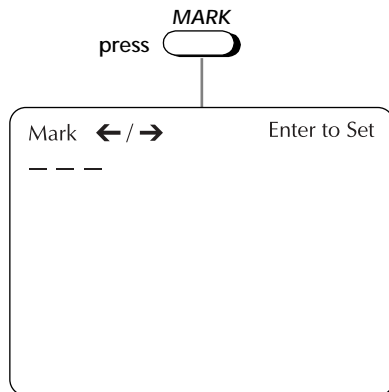

SET BOOKMARKS

- 1 While a DVD is playing, press MARK. The "Mark" header will appear on the screen.
- 2 Use the LEFT/RIGHT arrow keys to select one of the three bookmark placeholders (- - -). The selected placeholder will blink.
- 3 When the DVD is at the scene you want to bookmark, press SETUP/ENTER. The placeholder will change to a number (1, 2 or 3).
- 4 The bookmark is set!
 - To quickly locate your bookmarks, see "Jump to Bookmarks" below.
 - To add up to 3 bookmarks, repeat steps 2-3.
 - To cancel a bookmark, select it and press CLEAR.
 - To exit the Bookmark menu, press MARK again.

JUMP TO BOOKMARKS

- 1 During playback, press MARK.
- 2 Use the LEFT/RIGHT arrow keys to move to a previously set bookmark.
- 3 Press PLAY ►|| to begin playback at the desired bookmark.
 - To cancel the bookmark, press CLEAR.
 - To exit the Bookmark menu, press MARK again.

Follow these steps to program playback of a DVD or CD in a random or preset order.

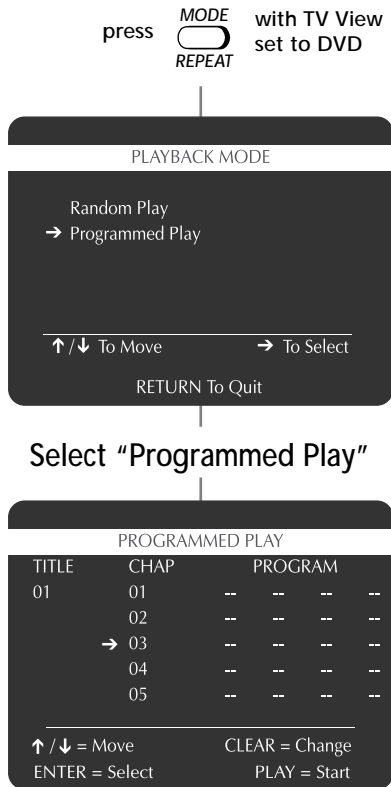

RANDOM PLAYBACK

Random Playback sets a random order for playback of chapters/tracks on a DVD or CD.

- 1 While a DVD/CD is stopped, press MODE/REPEAT.
- 2 Use the UP/DOWN arrow keys to move the pointer to "Random Play," then press the RIGHT arrow key to select. The disc will begin playback automatically in random order.
- 3 Press CLEAR to cancel "Random Play."

PROGRAMMED PLAYBACK

Programmed Playback lets you set a custom order for playback of chapters/tracks on a DVD or CD.

- 1 While a DVD/CD is stopped, press MODE/REPEAT.
- 2 Use the UP/DOWN arrow keys to move the pointer to "Programmed Play," then press the RIGHT arrow key to select.
- 3 Use the UP/DOWN arrow keys to move the pointer to the desired chapter/track in your playback list, then press SETUP/ENTER to add it to the list.
 - Continue in this fashion until all desired chapters/tracks are added.
 - To change a selection, press CLEAR and enter a new chapter/track.
- 4 Press PLAY/PAUSE. The disc will begin playback in the custom programmed order.
 - To cancel "Programmed Play," press OPEN/CLOSE to open the disc drawer.

Follow these steps to playback MP3 files burned on a CD-R disc.

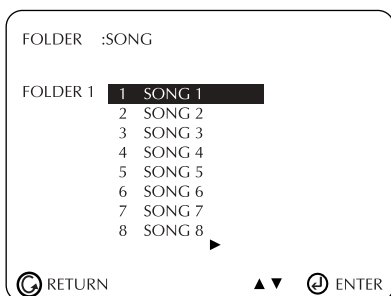
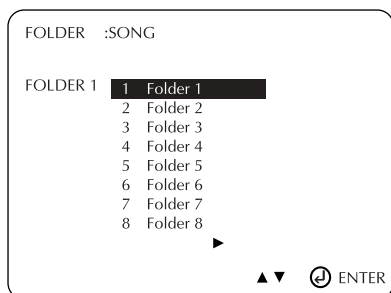

1 INSERT CD-R

Insert a CD-R with MP3 files into the DVD deck.

- The MP3 menu will appear after a few seconds and the first song on the disc will begin playing

2 SELECT FOLDER

Use the UP/DOWN arrow keys to select the folder on the CD-R which contains the MP3 files you want to hear, then press SETUP/ENTER.

- If there are more than 8 folders on the disc, use the LEFT/RIGHT arrow keys to view additional folders.

3 SELECT MP3 FILES

Use the UP/DOWN arrow keys to select the desired MP3 file.

- If there are more than 8 MP3 files in the selected folder, use the LEFT/RIGHT arrow keys to view additional MP3 files.
- File names are truncated to eight characters: the first six characters of the song, plus an asterisk (*), then a number.
- Press RETURN to back up to the previous menu and select another folder.

4 PLAY MP3 FILE

Press PLAY/PAUSE ►|| or SETUP/ENTER to play the selected song.

- While the song is playing, you can use the UP/DOWN arrows to browse through other folders.

5 STOP MP3 SELECTION

Press STOP ■ to stop playback.

5

VCR RECORDING

This Chapter will show you how to record television programs in the VCR deck and set recording preferences.

Follow these steps to record a television show in the VCR deck.

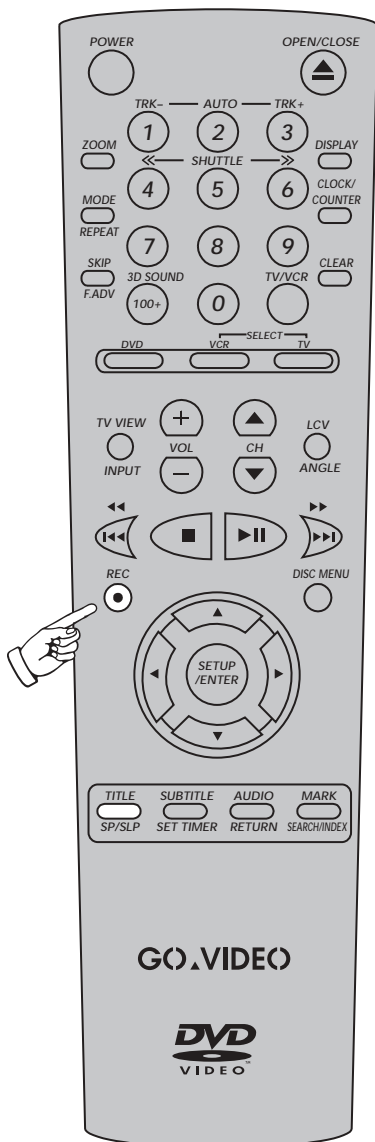

1 INSERT TAPE

Insert a VHS tape with a record safety tab into the VCR deck.



2 SET RECORD SPEED

Press SP/SLP to set the record speed to the following:

- **SP** – Standard Play, for best quality.
- **SLP** – Super Long Play, for maximum recording time (3 times longer than SP).

3 SELECT DESIRED CHANNEL

Use the 0-9 keys or the CH ▲▼ keys to select the channel you wish to record.

4 START RECORDING

Press REC ●.

5 OPTIONS DURING RECORDING

- Press PLAY/PAUSE ►|| to pause recording.
- Press REC ● again to resume recording.
- Press STOP ■ to stop recording.
- To watch another TV program, press TV/VCR to switch to TV mode, then select a channel on your TV.
- To watch a DVD, make sure the DVD deck is selected, then press PLAY/PAUSE ►||.
- **One-Touch Recording** – To add recording time in 30 minute increments, press REC ● repeatedly. "OTR" will appear on the on-screen display, followed by the number of minutes the DVD+VCR will record. Continue pressing REC ● to add up to 9 hours and 30 minutes. When the recording time has elapsed, the DVD+VCR will stop recording automatically.
- **OTR Loop Record** – When you reach OTR 9:30, press REC ● again to enter OTR Loop mode. The VCR deck will record over and over again until you press STOP ■. This can be used for continuous recording of security cameras.

NOTE

- If you press POWER during One-Touch Recording, the DVD+VCR will turn off automatically when the recording time has elapsed.

Follow these steps to set the default VCR record settings for your DVD+VCR.

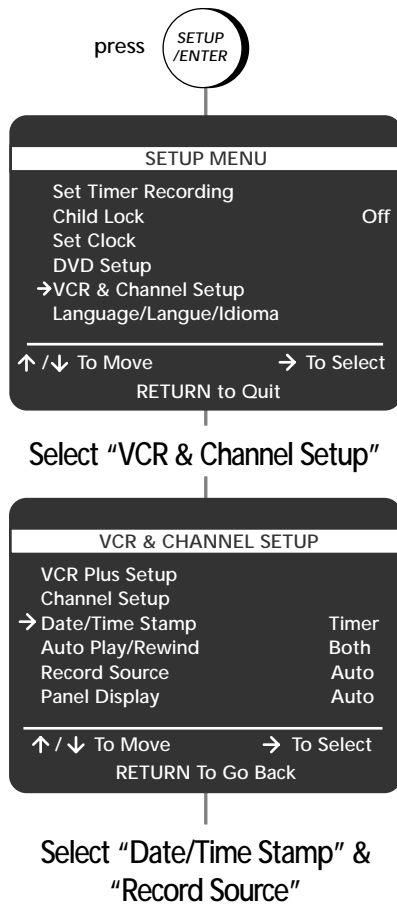

1 OPEN "SETUP MENU"

Press SETUP/ENTER.

2 SELECT "VCR & CHANNEL SETUP"

Use the UP/DOWN arrow keys to move the pointer to "VCR & Channel Setup," then press the RIGHT arrow key to select.

3 ADJUST RECORD SETTINGS

Use the UP/DOWN/RIGHT arrow keys to select and set the following:

Date/Time Stamp

Timer – The date, time, and record source will be "stamped" (superimposed) briefly at the start of all timer recordings.

All – The date, time, and record source will be stamped briefly at the start of all recordings.

None – The date, time, and record source will not be stamped.

Record Source

Set your VCR's default record source to one of the following:

Auto – The VCR will record whatever is currently visible on screen (default setting).

Tuner – The VCR will record from the DVD+VCR's built-in television tuner.

Line 1 – The VCR will record from an external source, such as a camcorder, connected to the front line inputs.

Line 2 – The VCR will record from an external source, such as a satellite receiver, connected to the rear line inputs.

DVD – The VCR will record from a DVD or CD playing in the DVD deck.



The DVD+VCR allows you to copy the contents of a DVD to a VHS tape with a press of the COPY button.

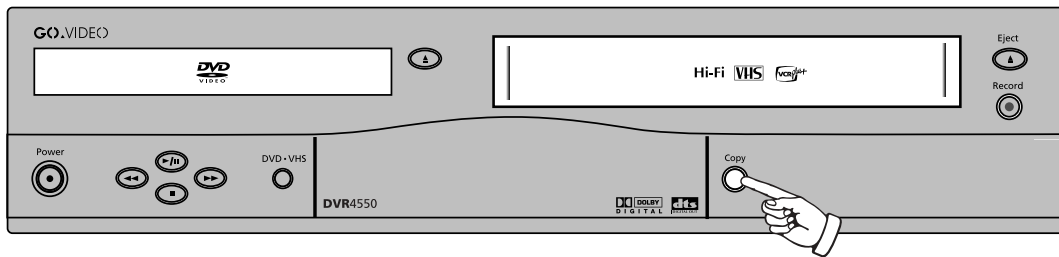

1 INSERT DISC

Insert the disc you wish to copy in the DVD deck and close the drawer.

2 INSERT VHS TAPE

Insert a VHS tape with a record safety tab into the VCR deck.

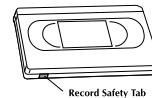

3 COPY THE DVD TO VHS TAPE

Press COPY on the DVD+VCR front panel.

- The DVD will begin playing and the VCR will begin recording (see note below).
- If the DVD disc menu appears, you may need to press PLAY/PAUSE ►|| manually on the DVD deck to begin copying.

4 STOP THE COPY PROCESS

When the DVD is finished playing, press VCR on the remote control and then press STOP ■ to end the copy.

- You must stop the copy process manually when the DVD movie ends, or the DVD may replay and record over and over again.

NOTE

- If the DVD you are attempting to copy is copy protected, you will not be able to copy the disc. It is not permitted to copy Macrovision® encoded DVDs.

6

TIMER RECORDING

This chapter provides step by step instructions for programming Timer Recordings.

Follow these steps to program your DVD+VCR to record up to 16 television shows.

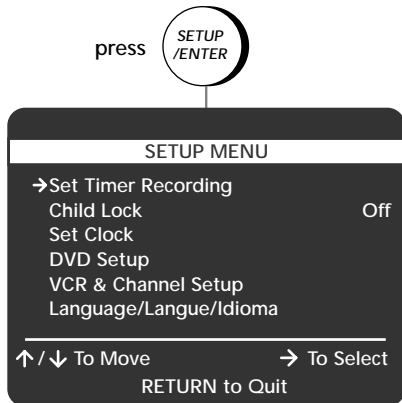

Select "Set Timer Recording"

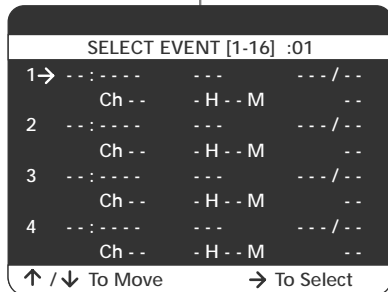

use **0** — **9** to select event 01-16

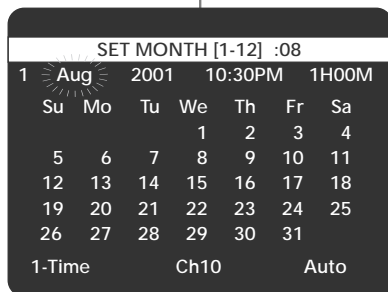

use **0** — **9** to set month, day, hour, minute, am/pm

continued...

NOTE

- If you select "Set Timer Recording" without having set the clock, the "Clock Settings" menu will appear. You MUST set the clock before you can program a Timer Recording (see page 45).

1 INSERT TAPE

Insert a blank tape with a record safety tab into the VCR deck.

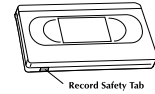

2 OPEN "SETUP MENU"

Press SETUP/ENTER.

3 SELECT "SET TIMER RECORDING"

Use the UP/DOWN arrow keys to move the pointer to "Set Timer Recording," then press the RIGHT arrow key to select.

4 SELECT EVENT NUMBER

Use the UP/DOWN arrow keys to move the pointer to any available event number from 1-16, then press the RIGHT arrow key to select.

- You can also use the 0-9 keys to directly select the desired event number.

5 SET DATE AND TIME

Use the 0-9 keys to set the date and time of the event. To edit an entry, press CLEAR and then enter the new numbers. To skip an entry without changing it, press the RIGHT arrow key.

Set Month

Enter the month as a 2-digit number; e.g., for January, press "01."

Set Day

Enter the day as a 2-digit number; e.g., for the ninth, press "09."

Set Hour

Enter the hour as a 2-digit number; e.g., for 12:00, press "12."

Set Minutes

Enter the minutes as a 2-digit number; e.g., for 12:00, press "00."

Set AM/PM

Press "1" for AM or "2" for PM.

...continued

SET LENGTH (H) [0-9] :00						
1	Aug	2001	10:30PM	1H00M		
Su	Mo	Tu	We	Th	Fr	Sa
			1	2	3	4
5	6	7	8	9	10	11
12	13	14	15	16	17	18
19	20	21	22	23	24	25
26	27	28	29	30	31	
1-Time		Ch10				Auto

press **0** — **9** to set hours and minutes

SET TYPE [1-4] : 1						
1	Aug	2001	10:30PM	1H00M		
Su	Mo	Tu	We	Th	Fr	Sa
			1	2	3	4
5	6	7	8	9	10	11
12	13	14	15	16	17	18
19	20	21	22	23	24	25
26	27	28	29	30	31	
1-Time		Ch10				Auto

press **1** — **4** to set type

SET SOURCE [1-4] : 1						
1	Aug	2001	10:30PM	1H00M		
Su	Mo	Tu	We	Th	Fr	Sa
			1	2	3	4
5	6	7	8	9	10	11
12	13	14	15	16	17	18
19	20	21	22	23	24	25
26	27	28	29	30	31	
1-Time		Ch10				Auto

press **1** — **3** to set source

SET SPEED [1-3] : 1						
1	Aug	2001	10:30PM	1H00M		
Su	Mo	Tu	We	Th	Fr	Sa
			1	2	3	4
5	6	7	8	9	10	11
12	13	14	15	16	17	18
19	20	21	22	23	24	25
26	27	28	29	30	31	
1-Time		Ch10				Auto

press **1** — **3** to set speed

continued...

6 SET LENGTH

Use the 0-9 keys to set the length of the event in hours and minutes.

Set Length (H)

Enter the hours as a 1-digit number; e.g., for one hour, press "1."

Set Length (M)

Enter the minutes as a 2-digit number; e.g., for 30 minutes, press "30."

7 SET TYPE

Press 1, 2, 3 or 4 to set how often the event will be recorded:

1 - 1-Time

The event will be recorded once.

2 - Mo-Fr

The event will be recorded weekdays only (Monday through Friday).

3 - Weekly

The event will be recorded once a week.

4 - Always

The event will be recorded every day.

8 SET SOURCE

Press 1, 2 or 3 to set the record source (if you are using a cable box, see note below):

1 - Ch##

Records from television. First, press 1 to select this option, then use the 0-9 keys to set the channel number you wish to record as a 2-digit number; e.g., to record on channel 8, press 1, then "08."

2 - Line 1

Records from an external source connected to the front line inputs.

3 - Line 2

Records from an external source connected to the rear line inputs.

9 SET SPEED

Press 1, 2, or 3 to set the record speed.

1 - Auto

Activates "Complete Program Record" (see note below).

2 - SP

Standard Play. Use for best quality (a T-120 tape will record for 2 hours).

3 - SLP

Super Long Play. Use for maximum recording time (a T-120 tape will record for 6 hours).

NOTE

- If you are recording with a cable box, set Source to Channel 2, 3, or 4—whichever your cable box uses—then select the desired channel on the cable box.

...continued



SELECT EVENT [1-16] :01			
1	→10:30 PM	On	Wednesdays
	Ch10	1H30M	Auto
2	--:--:--	---	---/--
	Ch --	-H --M	--
3	--:--:--	---	---/--
	Ch --	-H --M	--
4	--:--:--	---	---/--
	Ch --	-H --M	--
↑ / ↓ To Move		→ To Select	

10 VIEW EVENT SUMMARY

Press RETURN to confirm the event and view a summary of all programmed events.

- The event is now stored in memory and will record at the scheduled time. It is not necessary to turn the DVD+VCR off or put it into a "Timer" mode; the event will record regardless of the state of the DVD+VCR.
- The "Timer" indicator will light on the front panel display. If there is a timer recording error, the "Timer" indicator will blink and an error message will appear on the screen (see "Timer Recording Errors" below).
- To program another event, select any available event number.
- To edit an event, select its event number.
- To delete an event, use the UP/DOWN arrow keys to select it, then press CLEAR.
- To exit the Select Event screen, press SETUP/ENTER.

TIMER RECORDING ERRORS

Tape Missing

Solution: Insert a tape in the VCR deck.

Tape Missing Tab

Solution: Insert a tape with a record safety tab.

Not Ready

Solution: The VCR deck is already in use. Press STOP ■ on this deck.

Overlapping Events

Solution: If two programmed events overlap, you will be prompted to either delete one of the events, or allow them to overlap. If you allow them to overlap, the event with the earliest starting time will be completely recorded, then the remainder of the event with the next earliest starting time will be recorded.

NOTE

- **Complete Program Record (CPR)** adjusts the record speed to make sure the tape does not run out before the Timer Recording is complete. With Record Speed set to "Auto," the DVD+VCR will begin recording in SP. It will then calculate how much time is remaining on the tape and adjust the record speed to SLP if necessary. If there is not enough room to record the entire show, the DVD+VCR will record in SLP until the end of the tape is reached.

This chapter provides step by step instructions for setting up and programming VCR Plus+ recordings, a patented and simplified method of timer recording.

Follow these steps to match your local channels to the VCR Plus+ preassigned channels. This process is known as "Channel Mapping" and must be done before you can begin using VCR Plus+.

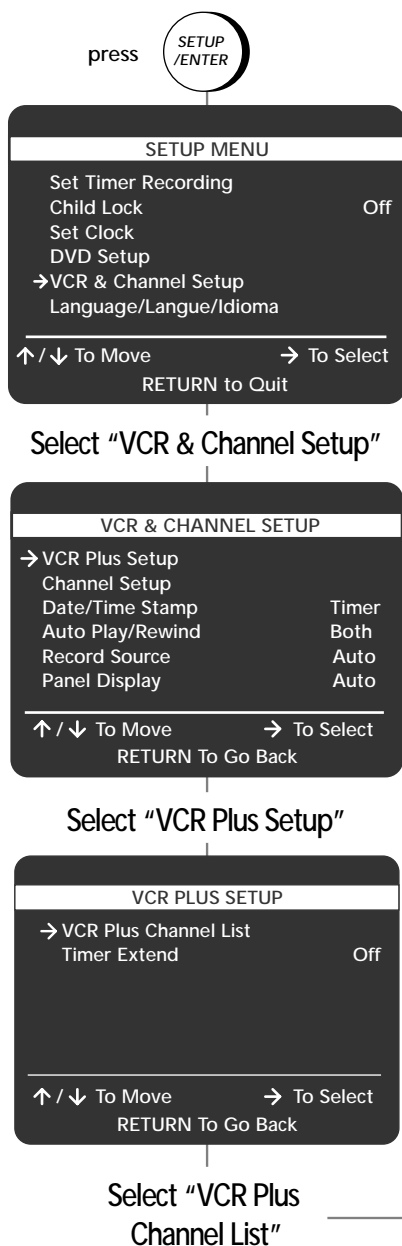

1 OPEN "SETUP MENU"

Press SETUP/ENTER.

2 SELECT "VCR & CHANNEL SETUP"

Use the UP/DOWN arrow keys to move the pointer to "VCR & Channel Setup," then press the RIGHT arrow key to select.

3 SELECT "VCR PLUS SETUP"

Use the UP/DOWN arrow keys to move the pointer to "VCR Plus Setup," then press the RIGHT arrow key to select.

4 SELECT "VCR PLUS CHANNEL LIST"

Press the RIGHT arrow key to select "VCR Plus Channel List."

5 MAP YOUR CHANNELS

Using the worksheet on the following page, determine the local equivalents of the VCR Plus+ channels for your viewing area. You can find this information in your local television listings or by contacting your local cable company.

- Use the UP/DOWN arrow keys to move up and down the channel list and use the 0-9 keys to edit the local channel.
- When finished, press RETURN to save and exit.

VCR PLUS CHANNEL LIST	
VCR+ CH	LOCAL CH
→ 01	01
02	02
03	03
04	04
05	05

↑ / ↓ To Move 0-9 To Change
Press RETURN To Finish

NOTE

- VCR Plus+ and PlusCode are registered trademarks of Gemstar Development Corporation. The VCR Plus+ system is manufactured under license from Gemstar Development Corporation.

Follow these steps to program a VCR Plus+ recording. You will need a local TV listing that includes VCR PlusCode numbers.

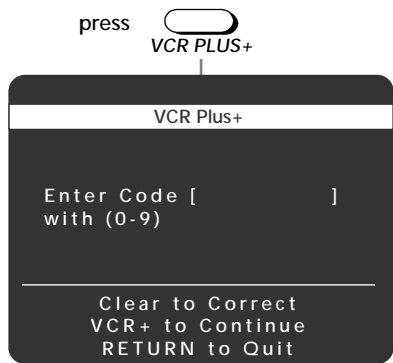

use -

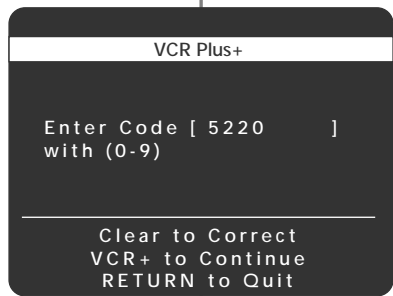

press VCR PLUS+

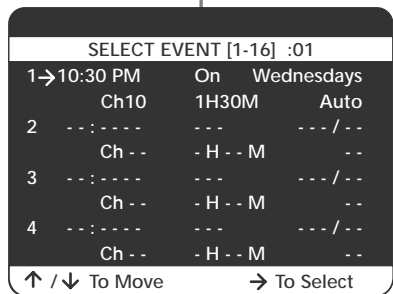

press repeatedly

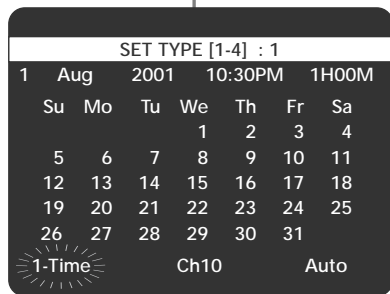

press - to set type

continued...

1 OPEN VCR PLUS+ MENU

Press VCR PLUS+ (see note below).

2 ENTER VCR PLUSCODE NUMBER

Use the 0-9 keys to enter the 2 to 8-digit VCR PlusCode number shown in your local television programming guide for the program you wish to record.

- To correct your entry, press CLEAR.
- Press VCR PLUS+ to continue.

3 VIEW EVENT SUMMARY

Basic programming is complete. The event will be recorded automatically on the date and time represented by the code you entered. As in Timer Recording, the event will appear on the Timer Summary screen.

- To set how often the event will record and/or to adjust the recording speed, continue with Step 4 below.
- To delete an event, use the UP/DOWN arrow keys to select it, then press CLEAR.
- To exit the Event Summary screen, press RETURN.

4 SELECT THE EVENT TO EDIT

Use the UP/DOWN arrow keys to move the pointer to the desired event number, then press the RIGHT arrow key to select.

5 SELECT "SET TYPE"

Press the RIGHT arrow key repeatedly until "Set Type" appears in the menu header.

- Do NOT make any changes to Set Month, Set Day, Set Hour, Set Minute, Set Length (H) or Set Length (M) because these were set automatically when you entered the VCR PlusCode.

6 SET TYPE (HOW OFTEN TO RECORD)

Press 1, 2, 3 or 4 to set how often the event will be recorded:

1 - 1-Time

The event will be recorded once.

NOTE

- If you haven't set the clock, the Clock Settings menu ("Set Month") will appear. You must set the local time before you can program a VCR Plus+ Recording (see page 45).

...continued

SET SPEED [1-3] : 1						
1	Aug	2001	10:30PM	1H00M		
Su	Mo	Tu	We	Th	Fr	Sa
			1	2	3	4
5	6	7	8	9	10	11
12	13	14	15	16	17	18
19	20	21	22	23	24	25
26	27	28	29	30	31	
1-Time		Ch10		Auto		

press **1** — **3** to set source

SELECT EVENT [1-16] :01			
1	→10:30 PM	On	Wednesdays
	Ch10	1H30M	Auto
2	--:--:--	--	-- / --
	Ch --	- H -- M	--
3	--:--:--	--	-- / --
	Ch --	- H -- M	--
4	--:--:--	--	-- / --
	Ch --	- H -- M	--
↑ / ↓ To Move		→ To Select	

2 - *Mo-Fr*

The event will be recorded weekdays only (Monday through Friday).

3 - *Weekly*

The event will be recorded once a week.

4 - *Always*

The event will be recorded every day.

7 SELECT "SET SPEED"

Press the RIGHT arrow key repeatedly until "Set Speed" appears in the menu header.

- Do NOT make any changes to Set Source because this was set automatically when you entered the VCR PlusCode.

8 SET RECORDING SPEED

Press 1, 2, or 3 to set the record speed:

1 - *Auto*

Activates "Complete Program Record" (see note below).

2 - *SP*

Standard Play. Use for best quality (a T-120 tape will record for 2 hours).

3 - *SLP*

Super Long Play. Use for maximum recording time (a T-120 tape will record for 6 hours).

9 CONFIRM SETTINGS

When all settings are complete, press RETURN to confirm the Timer event and view a summary of all programmed events.

- The event is now stored in memory and will record at the scheduled time. It is not necessary to turn the DVD+VCR off; the event will record regardless of the state of the DVD+VCR.
- The "Timer" indicator will light on the front panel display. If there is a timer recording error, the "Timer" indicator will blink and an error message will appear on the screen (see "Timer Recording Errors" on page 27).
- To exit the Event Summary screen, press RETURN.

NOTE

- **Complete Program Record (CPR)** adjusts the record speed to make sure the tape does not run out before the Timer Recording is complete. With Record Speed set to "Auto," the DVD+VCR will begin recording in SP. It will then calculate how much time is remaining on the tape and adjust the record speed to SLP if necessary. If there is not enough room to record the entire show, the DVD+VCR will record in SLP until the end of the tape is reached.



Follow these steps to extend VCR Plus+ recording a few minutes before and after the scheduled event. This will help to ensure that the entire event is recorded.

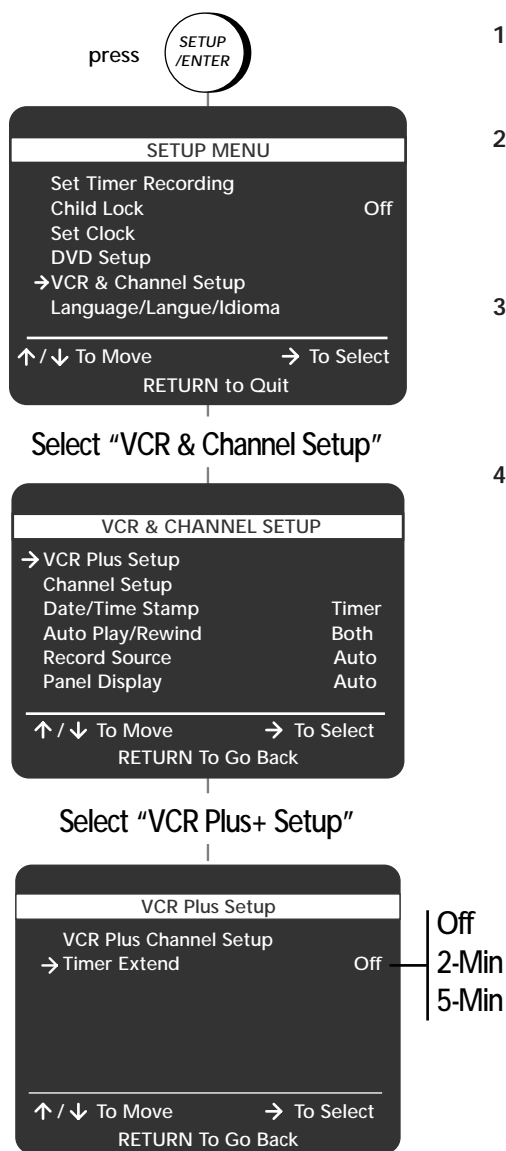

1 OPEN "SETUP MENU"

Press SETUP/ENTER.

2 SELECT "VCR & CHANNEL SETUP"

Use the UP/DOWN arrow keys to move the pointer to "VCR & Channel Setup," then press the RIGHT arrow key to select.

3 SELECT "VCR PLUS SETUP"

Use the UP/DOWN arrow keys to move the pointer to "VCR Plus Setup," then press the RIGHT arrow key to select.

4 SET "TIMER EXTEND"

Use the UP/DOWN arrow keys to move the pointer to "Timer Extend," then press the RIGHT arrow key to select and set the following:

- **Off** – Timer Extend is disabled.
- **2-Min** – VCR Plus+ recordings will record 2 minutes before and after their scheduled times.
- **5-Min** – VCR Plus+ recordings will record 5 minutes before and after their scheduled times.

8

SEARCH / INDEX

This Chapter will show you how to locate recordings on your VHS tapes using Index Marks.

Follow these steps to place Index Marks on your recordings.

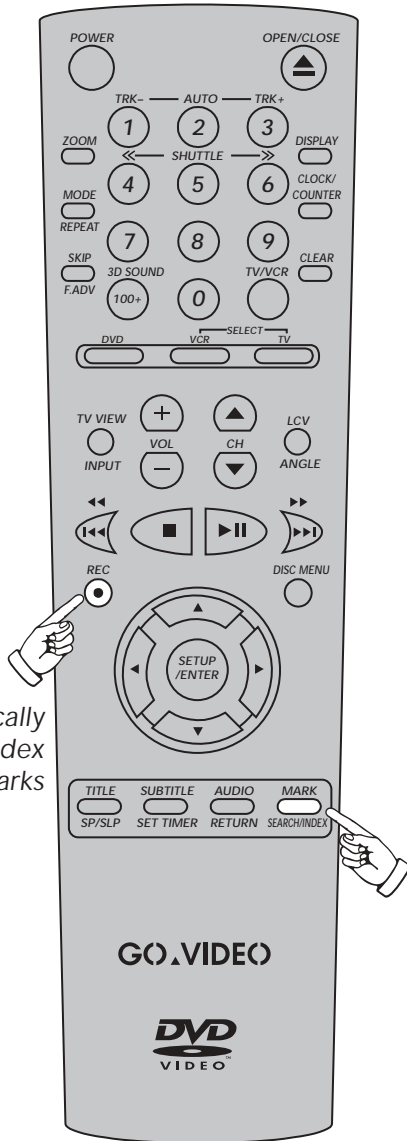

Automatically Places Index Marks

Press for Manual Index Marks

What are Index Marks?

Index Marks are like bookmarks on your videotapes. They are inserted automatically at the start of every recording, or you can place them manually anywhere on a tape. Later you can locate these "bookmarks" using Index Search or Index Scan (see page 34).

Automatic Index Marks

The DVD+VCR places an Index Mark on your tape the moment you start recording. This includes standard recording, One Touch Recording, Timer Recording or copying.

Manual Index Marks

You can place an Index Mark manually any time a tape is recording by pressing SEARCH/INDEX. "Index" will flash briefly on the On-Screen Display while the mark is recorded.

▶ Follow these steps to locate recordings by scanning or searching for Index Marks.

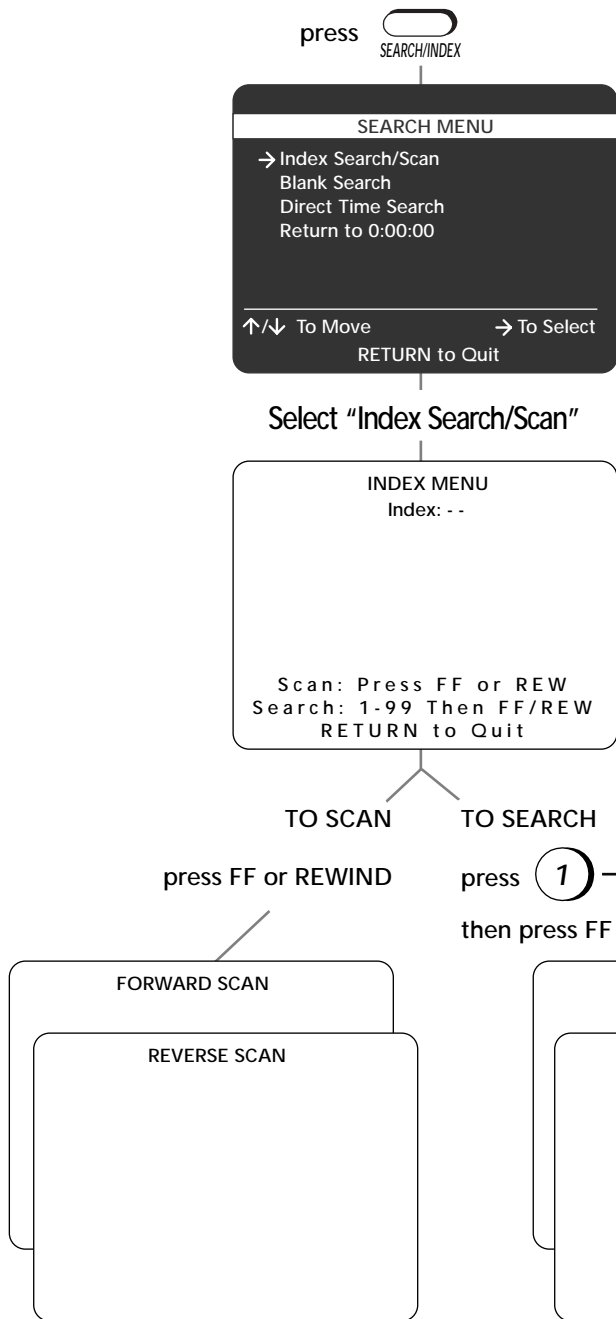

- 1 **INSERT TAPE**
Insert a videotape in the VCR deck.

- 2 **OPEN "SEARCH MENU"**
While the tape is stopped or playing, press SEARCH/INDEX.

- 3 **SELECT "INDEX SEARCH/SCAN"**
Use the UP/DOWN arrow keys to move the pointer to "Index Search/Scan," then press the RIGHT arrow key to select.

- 4 **SEARCH/SCAN FOR INDEX MARKS**

Scan

Press FAST-FORWARD ►► or REWIND ◀◀ to begin scanning for all Index Marks forwards or backwards.

- When Index Scan locates an Index Mark, it will play the tape for 5 seconds. If it is the scene you want to watch, press PLAY/PAUSE ►◄. If it is not, the DVD+VCR will automatically search for the next Index Mark.

Search

Enter a number from 1 to 99; e.g., for "5" press "0-5." Then press FAST-FORWARD ►► or REWIND ◀◀ to begin searching forward or backward the specified number of Index Marks.

- When the VCR locates the Index Mark, it will play the tape.

NOTE

• **Auto Show Finder** - Use Index Scan with the Date/Time Stamp to quickly find Timer Recordings on your tapes. For example, when Index Scan stops at an Index Mark and plays a few seconds of tape, you will see the date and time the show was recorded.

Follow these steps to find the nearest blank segment of tape, find a specific tape counter position, or return to 0:00:00.

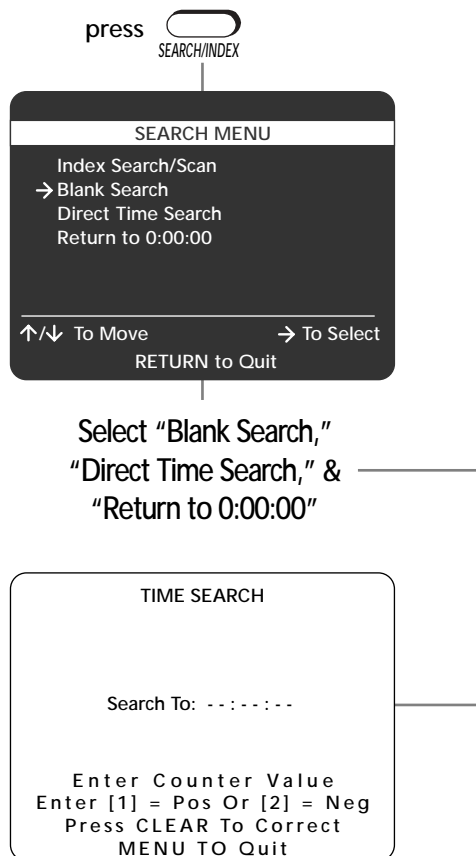

1 INSERT TAPE

Insert a VHS tape in the VCR deck.

2 OPEN "SEARCH MENU"

While the tape is stopped or playing, press SEARCH/INDEX.

3 SELECT A SPECIAL SEARCH FUNCTION

Use the UP/DOWN/RIGHT arrow keys to select from the following:

Blank Search

Searches for the next available blank (unrecorded) segment on your tape. This makes it easy to find available space when recording TV shows.

- If the DVD+VCR finds blank tape, it will stop at the beginning of the blank segment.
- If the DVD+VCR does not find blank tape, it will eject the tape.

Direct Time Search

Locates a specific tape counter position in hours, minutes and seconds.

- Press 1 for positive or 2 for negative counter values.
- Use the 0-9 keys to enter the desired time in hours, minutes and seconds.
- Press CLEAR if you need to back up and reenter a number.
- Press SEARCH/INDEX to advance the tape to the specified time.

Return to 0:00:00

Advances your videotape to tape counter position 0:00:00.

- When selected, the DVD+VCR will automatically rewind or fast-forward the tape to counter position 0:00:00.

ADVANCED CONNECTIONS

This Chapter will show you how to use the S-Video and Component Video outputs, as well as how to connect additional audio/video devices to your DVD+VCR.

Follow these steps to connect the DVD+VCR to your TV using the S-Video or Component Video outputs.

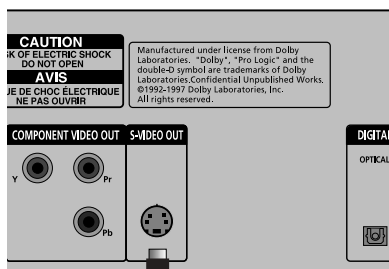

To S-Video Input
on your TV

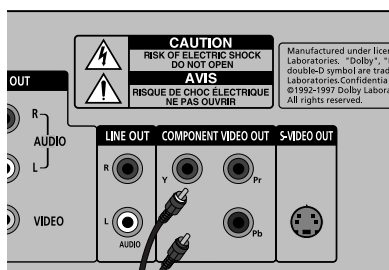

To Component
Video Inputs
on your TV

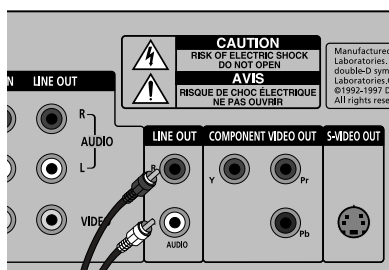

To Left/Right
Audio Inputs
on your TV

1 CONNECT S-VIDEO OUT TO TV

Connect an S-Video cable from the S-Video Output on the back panel of the DVD+VCR to the S-Video Input on your television.

OR

CONNECT COMPONENT VIDEO OUT TO TV

Connect a component video cable from the Component Video Output on the back panel of the DVD+VCR to the Component Video Input on your television.

2 CONNECT AUDIO OUT

Connect RCA audio cables from the Right/Left Line Out jacks on the back panel of the DVD+VCR to the Left/Right Audio Line In jacks on your television.

- You must use these Line Out audio jacks when connecting the DVD+VCR to your TV with the S-Video or Component Video Out.

3 SELECT "ALT VIDEO OUT"

Please continue on the next page with "Alt Video Out Setting" to activate your connection in the DVD+VCR menu system.

NOTES

- You must set the "Alt Video Out Setting" on page 37 to activate S-Video or Component Video.
- You can ONLY watch the DVD player with the S-Video or Component Video connection method. The tuner and VCR will still be viewed through the RF or line outputs.

If you have connected the DVD+VCR to your TV using the S-Video or Component Video Out jacks, you MUST set the "Alt Video Out" selection in the On-Screen menu system.

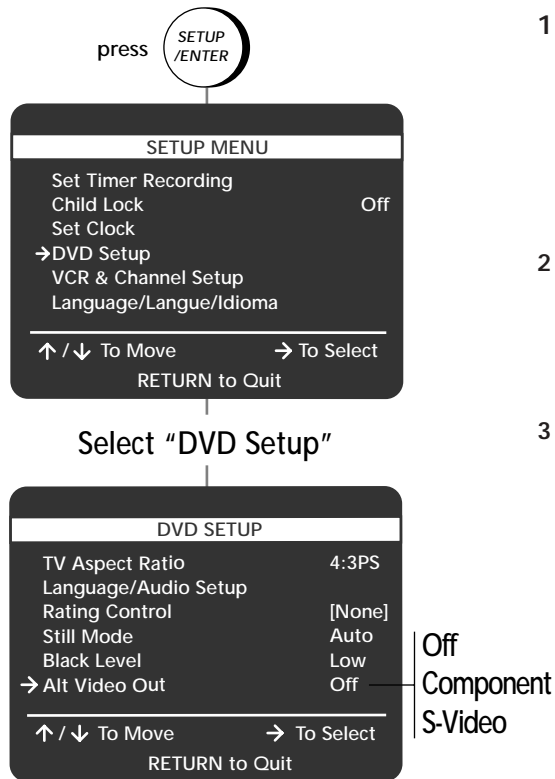

1 OPEN "SETUP MENU"

Press SETUP/ENTER.

- Make sure the DVD deck is stopped before pressing SETUP/ENTER. You will not be able to enter the "DVD Setup" menu if a DVD is playing.

2 SELECT "DVD SETUP"

Use the UP/DOWN arrow keys to move the pointer to "DVD Setup," then press the RIGHT arrow key to select.

3 SET "ALT VIDEO OUT"

Use the UP/DOWN arrow keys to move the pointer to "Alt Video Out," then press the RIGHT arrow key to select from the following:

Off

Indicates that you are using the standard RF or Line Out jacks to connect your DVD+VCR to your TV or display device. You are not using the S-Video or Component connection.

Component

The Component Video Output will be enabled. The S-Video output will be disabled.

S-Video

The S-Video Output will be enabled. The Component video output will be disabled.

NOTE

- You can ONLY watch the DVD player through the S-Video or Component Video connection method. The tuner and VCR will still be viewed through the RF or line inputs.

Follow these steps to connect your DVD+VCR to an A/V receiver or stereo system using the Line Out or Digital Audio Out jacks.

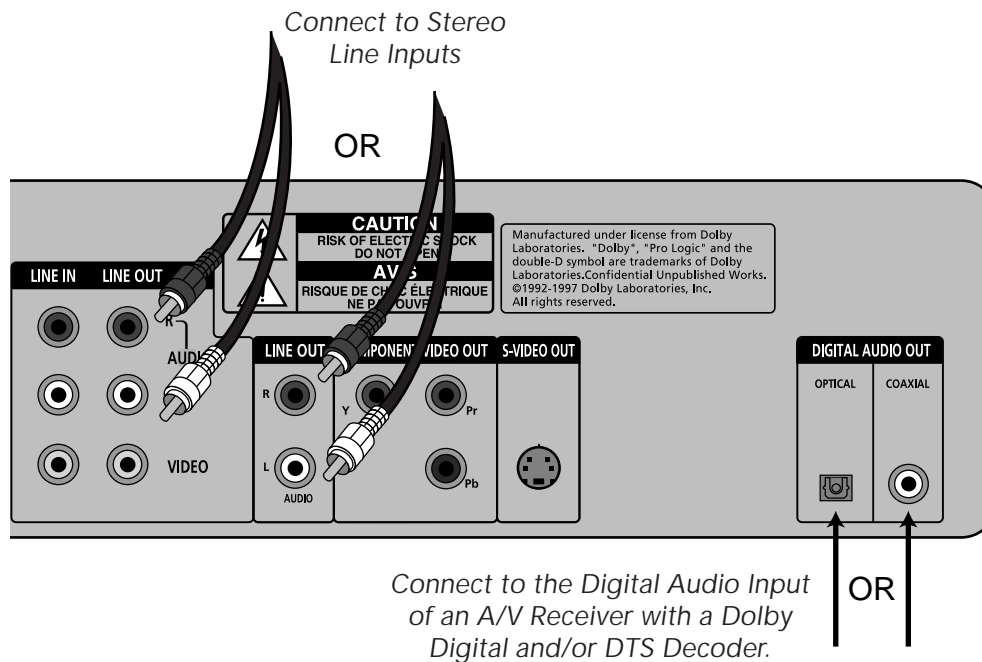

STEREO CONNECTION

- 1 CONNECT DVD+VCR TO STEREO**
Connect RCA cables from either of the "Line Out" audio jacks (R and L) on the back of the DVD+VCR to the line inputs of your stereo receiver.
- 2 SET STEREO TO AUXILIARY MODE**
Set your stereo receiver to "Aux" or "Line" (refer to your stereo owner's guide for the proper setting).

DIGITAL AUDIO OUT CONNECTION

- 1 CONNECT DVD+VCR TO A/V RECEIVER**
Connect EITHER a digital optical cable OR a digital coaxial cable from the Digital Audio Out jacks on the back panel of the DVD+VCR to their corresponding Digital Audio Inputs on your A/V Receiver.
 - Use whichever connection is available on your A/V Receiver (Optical or Coaxial).
- 2 SET DOLBY & DTS DECODER SETTINGS**
If your A/V Receiver is equipped with a Dolby Digital and/or DTS Decoder, you must enable these options in the menu system (see next page).

NOTE

- The Digital Audio Out connections ONLY carry DVD audio—not the VCR or tuner.

If you connected the DVD+VCR to your A/V receiver with the Optical or Coaxial Digital Audio Out AND your A/V receiver is equipped with a Dolby Digital or DTS Decoder, you must enable the correct digital output in the menu system.



- 1 **OPEN "SETUP MENU"**
Press SETUP/ENTER.
 - Make sure the DVD deck is stopped before pressing SETUP/ENTER. You will not be able to enter the "DVD Setup" menu if a DVD is playing.

- 2 **SELECT "DVD SETUP"**
Use the UP/DOWN arrow keys to move the pointer to "DVD Setup," then press the RIGHT arrow key to select.

- 3 **SELECT "LANGUAGE/AUDIO SETUP"**
Use the UP/DOWN arrow keys to move the pointer to "Language/Audio Setup," then press the RIGHT arrow key to select.

- 4 **SET "DOLBY D DECODER"**
Use the UP/DOWN arrow keys to move the pointer to "Dolby D Decoder," then press the RIGHT arrow key to select from the following:
 - No** – Indicates that your A/V Receiver is NOT equipped with a Dolby Digital Decoder.
 - Yes** – Indicates that your A/V Receiver is equipped with a Dolby Digital Decoder.

- 5 **SET "DTS DECODER"**
Use the UP/DOWN arrow keys to move the pointer to "DTS Decoder," then press the RIGHT arrow key to select from the following:
 - No** – Indicates that your A/V Receiver is NOT equipped with a DTS decoder.
 - Yes** – Indicates that your A/V Receiver is equipped with a DTS decoder.

NOTES

- You MUST enable this feature in the menu system to prevent damage to your speakers.
- Select "Yes" ONLY if you have connected a Dolby Digital and/or DTS-equipped A/V Receiver to the Digital Output (optical or coaxial) on the DVD+VCR back panel. The same settings apply to both digital outputs.

Follow these steps to connect your DVD+VCR to an external audio/video component, such as a camcorder, video game, etc.

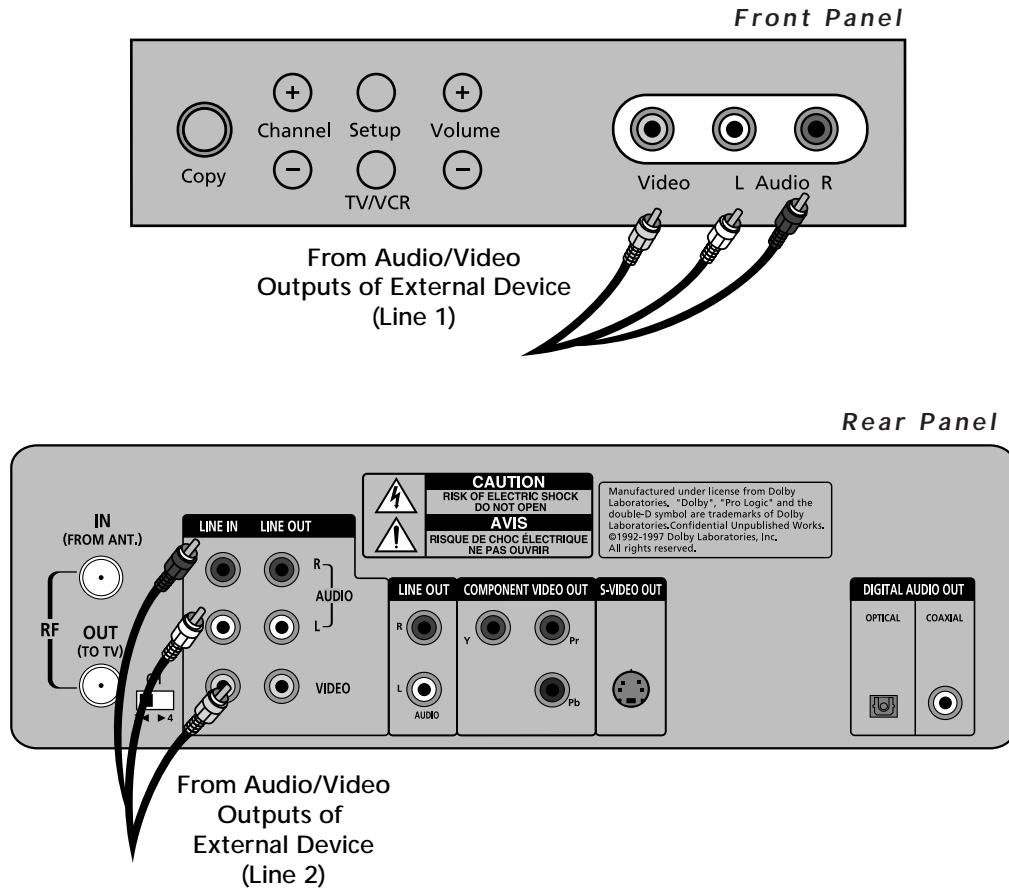

1 CONNECT DEVICE TO VCR

Connect RCA cables from the audio/video outputs of your external device to the audio/video inputs on the front (Line 1) or rear (Line 2) of the DVD+VCR.

2 EXTERNAL DEVICE OPTIONS

Once you have connected an external device to your DVD+VCR, you can perform the following functions:

Watch Device

Press TV VIEW until playback from "Line 1" or "Line 2" appears on your TV screen.

Record Device

Press TV VIEW until playback from "Line 1" or "Line 2" appears on your TV screen, then press REC on the VCR deck (make sure a tape is inserted and the VHS deck is selected).

Timer Record From Device

Select "Line 1" or "Line 2" as your Record Source in the Timer Record menu; see pages 25-26. All other Timer Record settings should be set in the usual manner.

Follow these instructions to connect a Cable Box to your DVD+VCR.

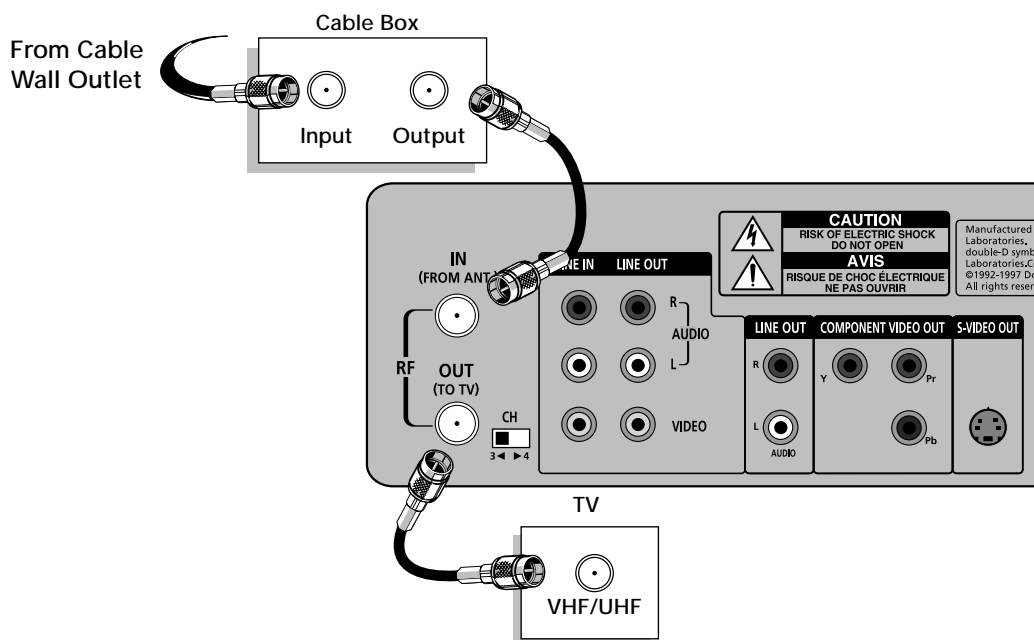

1 CONNECT CABLE TO CABLE BOX

Connect an RF coaxial cable from your cable wall outlet to the Input jack on the Cable Box.

2 CONNECT CABLE BOX TO DVD+VCR

Connect a second RF coaxial cable from the Output jack on the Cable Box to the "IN (FROM ANT.)" jack on the back panel of the DVD+VCR.

3 CONNECT DVD+VCR TO TV

Connect the supplied RF coaxial cable from the "OUT (TO TV)" jack on the back panel of the DVD+VCR to your television's "Antenna In" jack.

4 PLUG IN DVD+VCR

Connect the DVD+VCR power cord to a standard 120V/60Hz wall outlet.

5 TURN ON DVD+VCR, TV & CABLE BOX

Press POWER on the DVD+VCR, TV, and Cable Box.

6 SET DVD+VCR OUTPUT CHANNEL

Set the CH (channel) switch on the back panel of the DVD+VCR to 3 or 4, whichever is NOT used by your cable box.

7 TUNE TV TO THE SAME CHANNEL

Tune your TV to the same channel you selected in step 6.

8 CONNECTION IS COMPLETE!

The "Language/Langue/Idioma" menu will appear on your television screen. Please proceed with Auto Setup on page 3.

- Use your cable box to select channels.
- If you are not getting a good picture, repeat steps 6 and 7 using the other channel; i.e., try channel 4 instead of channel 3.

Follow these steps if you have a cable box and want to be able to watch a second channel while recording a TV program.

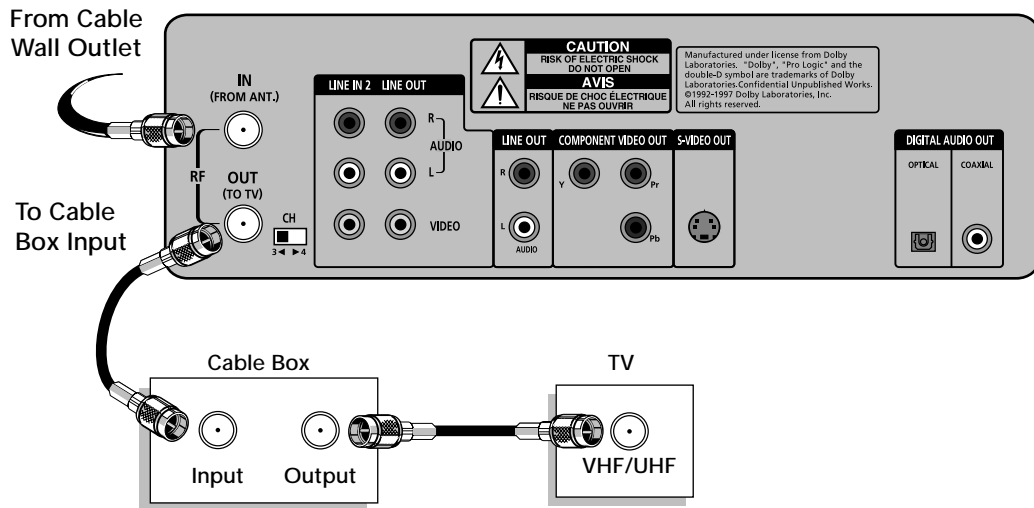

- 1 **CONNECT CABLE TO TV**
Connect an RF coaxial cable from the wall outlet to the "IN (FROM ANT.)" jack on the back panel of the DVD+VCR.
- 2 **CONNECT DVD+VCR TO CABLE BOX**
Connect the RF coaxial cable from the "OUT (TO TV)" jack on the back panel of the DVD+VCR to the Input jack on the Cable Box.
- 3 **CONNECT CABLE BOX TO TV**
Connect an RF coaxial cable from the Output jack on the Cable Box to the "Antenna In" connection on the back of the TV.
- 4 **TUNE THE TV**
Set the TV to channel 3 or 4, whichever is used by your cable box.
- 5 **TUNE CABLE BOX**
With all three devices turned on, set your Cable Box to channel 3 or 4 (whichever is set on the DVD+VCR), then press SETUP/ENTER.
- 6 **CONNECTION IS COMPLETE!**
The "Language/Langue/Idioma" menu will appear on your television screen. Please proceed with Auto Setup on page 3.

NOTES

- To view cable box channels, set the TV/VCR switch to TV. To watch the DVD+VCR through the RF output, set the TV/VCR switch to VCR and tune channel 3 or 4 on the cable box.
- With this hookup, you can watch scrambled channels, but you will not be able to record them.

SYSTEM SETTINGS

This Chapter will show you how to customize your DVD+VCR experience, with settings to adjust the language, time, channels, displays and more.

Follow these steps to set the On-Screen menu language to English, French or Spanish.

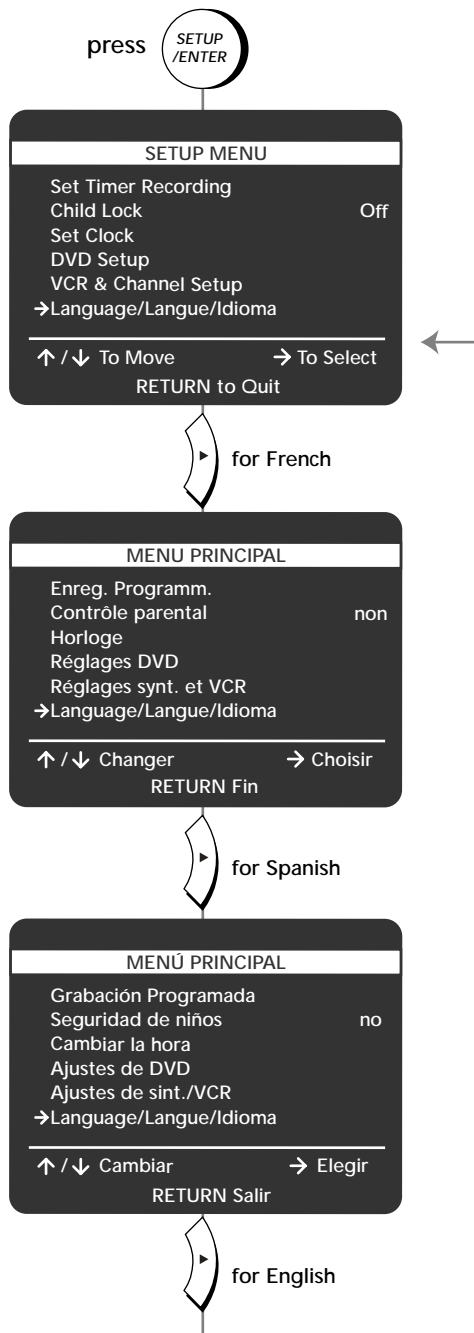

1 OPEN "SETUP MENU"

Press SETUP/ENTER.

2 SET THE LANGUAGE

Use the UP/DOWN arrow keys to move the pointer to "Language/Langue/Idioma," then press the RIGHT arrow key repeatedly to set the On-Screen menu language to English, French or Spanish.

NOTE

- Each time you press the RIGHT arrow key to select "Language/Langue/Idioma," the entire menu will be translated into English, French or Spanish.



Follow these steps to turn Auto Clock Set on or off. You can also specify the time zone and the channel that Auto Clock Set uses to determine your local time.

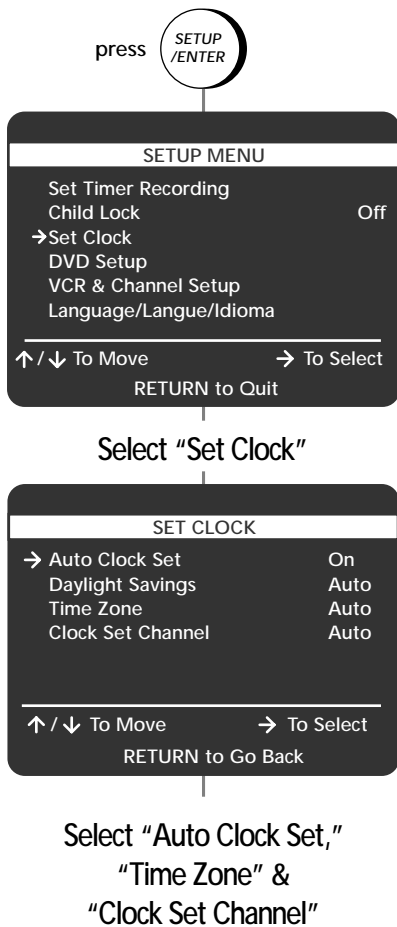

1 OPEN "SETUP MENU"

Press SETUP/ENTER.

2 SELECT "SET CLOCK"

Use the UP/DOWN arrow keys to move the pointer to "Set Clock," then press the RIGHT arrow key to select.

3 ADJUST CLOCK SETTINGS

Use the UP/DOWN/RIGHT arrow keys to select and set the following:

Auto Clock Set

On – Auto Clock Set will search for a local channel and detect the time automatically each time the unit is powered off.

Off – Auto Clock Set will be disabled. You must set the clock manually (see page 45).

Time Zone

Auto – Automatically detects your local time zone.

Eastern – Selects Eastern Standard Time.

Central – Selects Central Standard Time.

Mountain – Selects Mountain Standard Time.

Pacific – Selects Pacific Standard Time.

Alaska – Selects Alaska Standard Time.

Hawaii – Selects Hawaii Standard Time.

Clock Set Channel

Auto – Automatically searches for a local channel broadcasting the time.

Ch## –If you know of a station in your area that broadcasts time information (such as PBS), you can set the Auto Clock Set channel manually. Use the 0-9 keys to set the desired channel.

Line 1 – Allows the clock to be set from an audio/video device attached to your DVD+VCR's front line input.

Line 2 – Allows the clock to be set from an audio/video device attached to your DVD+VCR's rear line input.

NOTES

- If "Auto Clock Set" is set to "Off," then "Time Zone" and "Clock Set Channel" will not appear on the Clock Settings menu.
- If the DVD+VCR sets your clock incorrectly, try adjusting "Time Zone," "Daylight Savings" and "Clock Set Channel."

If Auto Clock Set is not available in your area, follow these steps to set the clock manually (see note below before proceeding).



Select "Set Clock"

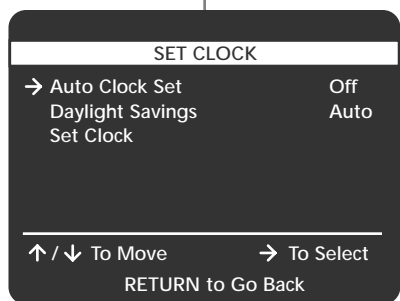

Turn "Auto Clock Set" Off

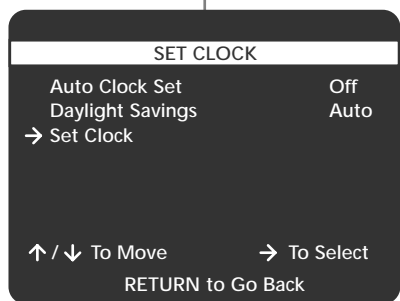

Select "Set Clock"

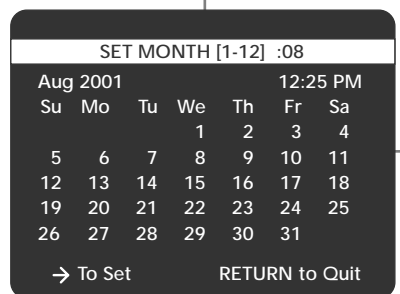

press 0 — 9
to SET MONTH,
SET YEAR,
SET DAY,
SET HOUR,
SET MINUTE,
SET AM/PM

- 1 **OPEN "SETUP MENU"**
Press SETUP/ENTER.
- 2 **SELECT "SET CLOCK"**
Use the UP/DOWN arrow keys to move the pointer to "Set Clock," then press the RIGHT arrow key to select.
- 3 **TURN OFF "AUTO CLOCK SET"**
Press the RIGHT arrow key to set Auto Clock Set to "Off."
- 4 **CHOOSE "SET CLOCK"**
Use the UP/DOWN arrow keys to move the pointer to "Set Clock," then press the RIGHT arrow key to select.
- 5 **SET THE TIME**
Use the 0-9 keys or the UP/DOWN arrow keys to set each of the following items. To skip an item, press the RIGHT arrow key:
Set Month – Enter the month as a 2-digit number; e.g., January = "01"
Set Year – Enter the year as a 2-digit number; e.g., 2001 = "01"
Set Day – Enter the day as a 2-digit number; e.g., the ninth = "09"
Set Hour – Enter the hour as a 2-digit number; e.g., 12:xx, = "12"
Set Minute – Enter the minute as a 2-digit number; e.g., xx:25 = "25"
Set AM/PM – Press "1" for AM or "2" for PM
- 6 **SAVE SETTINGS**
Press SETUP/ENTER to save and exit the menu system.

NOTE

- If Auto Clock Set is available but has set the time incorrectly, try adjusting Daylight Savings Time (page 46), Time Zone (page 55) and Clock Set Channel (page 55) before setting the clock manually.



Follow these steps to set Daylight Savings Time manually. You should only set "Daylight Savings" if Auto Clock Set has set the time incorrectly.

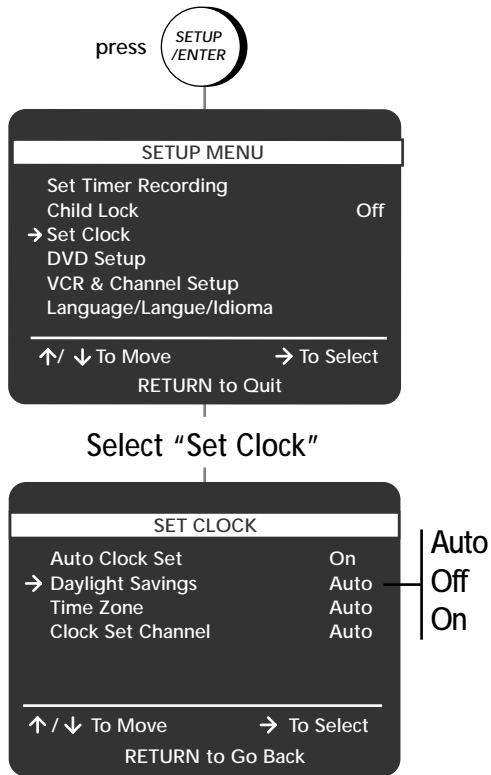

- 1 OPEN "SETUP MENU"**
Press SETUP/ENTER.
- 2 SELECT "SET CLOCK"**
Use the UP/DOWN arrow keys to move the pointer to "Set Clock," then press the RIGHT arrow key to select.
- 3 SET "DAYLIGHT SAVINGS"**
Use the UP/DOWN arrow keys to move the pointer to "Daylight Savings," then press the RIGHT arrow key to select from the following:
 - Auto** – The DVD+VCR will automatically use local channel information to determine the status of Daylight Savings Time in your area, and then set the clock accordingly.
 - Off** – The DVD+VCR will not adjust the clock for Daylight Savings Time.
 - On** – The DVD+VCR will adjust the clock for Daylight Savings Time as follows: One hour will be added to the time at 2:00 AM on the first Sunday of April and one hour will be subtracted from the time at 2:00 AM on the last Sunday in October.

NOTES

- If "Auto Clock Set" is set to "Off," then "Time Zone" and "Clock Set Channel" will not appear on the "Clock Settings" menu.
- If you are an Arizona resident, set "Daylight Savings" to "Off" and set "Time Zone" to "Mountain" (see page 44).

Follow these steps to set all Channel Settings for your DVD+VCR.

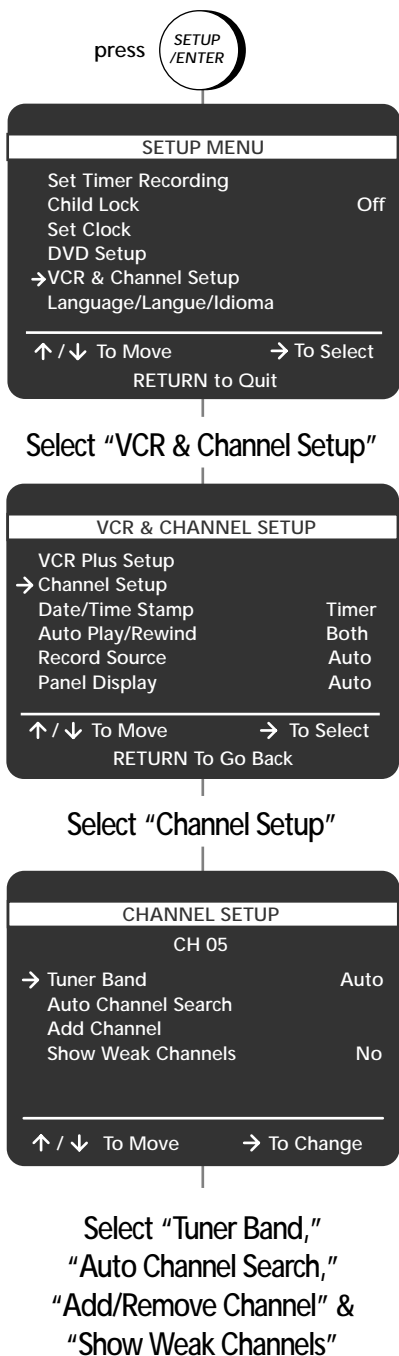

- 1 **OPEN "SETUP MENU"**
Press SETUP/ENTER.
- 2 **SELECT "VCR & CHANNEL SETUP"**
Use the UP/DOWN arrow keys to move the pointer to "VCR & Channel Setup," then press the RIGHT arrow key to select.
- 3 **SELECT "CHANNEL SETUP"**
Use the UP/DOWN arrow keys to move the pointer to "Channel Setup," then press the RIGHT arrow key to select.
- 4 **ADJUST CHANNEL SETTINGS**
Use the UP/DOWN/RIGHT arrow keys to select and set the following:

Tuner Band

Auto – Automatically detects whether you are receiving channels from antenna or cable (CATV).

Antenna – Specifies that you are receiving channels from an indoor/outdoor antenna.

Cable – Specifies that you are receiving channels from cable (CATV).

Auto Channel Search

Automatically searches for all available channels and stores them in memory. When finished, the DVD+VCR will display the lowest channel found.

Add/Remove Channel

Use the 0-9 keys to enter the channel number you wish to add or remove, then press the RIGHT arrow key to add or remove the channel.

Show Weak Channels

No – A blue screen will appear when a weak channel is received.

Yes – Channels with weak signal strength will be displayed instead of being replaced with a blue screen.

CHILD LOCK

Follow these steps to lock the front panel to prevent children from tampering with the DVD+VCR. Child Lock disables all front panel keys so the DVD+VCR can be operated only with the remote control.

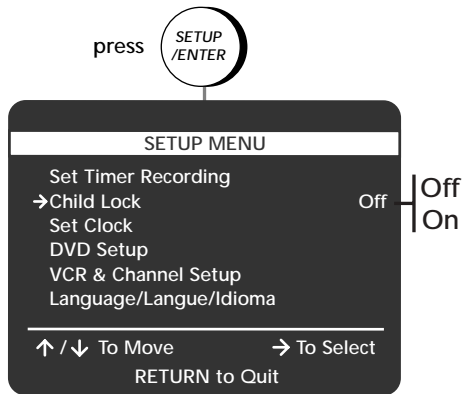

1 OPEN THE "SETUP MENU"

Press SETUP/ENTER.

2 SELECT "CHILD LOCK"

Use the UP/DOWN arrow keys to move the pointer to "Child Lock," then press the RIGHT arrow key to select from the following:

- **Off** - Child Lock is disabled. The front panel keys are fully functional.
- **On** - Child Lock is enabled. The front panel keys are locked.

NOTES

- You must use the remote control to disable Child Lock and restore normal front panel operation.
- The "Auto Play" and "Auto Power On" features are also disabled with Child Lock on.

Follow these steps to activate Auto Play (which plays tapes automatically when they are inserted) and Auto Rewind (which rewinds tapes automatically when they are finished playing).



- 1 OPEN THE "SETUP MENU"**
Press SETUP/ENTER.
- 2 SELECT "VCR & CHANNEL SETUP"**
Use the UP/DOWN arrow keys to move the pointer to "VCR & Channel Setup," then press the RIGHT arrow key to select.
- 3 SELECT "AUTO PLAY/REWIND"**
Use the UP/DOWN arrow keys to move the pointer to "Auto Play/Rewind," then press the RIGHT arrow key to select from the following:
 - **Both** - Enables both Auto Play and Auto Rewind.
 - **Play** - Enables Auto Play only. Tapes without Record Safety Tabs will play automatically when you insert them.
 - **Rew** - Enables Auto Rewind only. Tapes will rewind automatically when they are done playing.
 - **None** - Disables both Auto Play and Auto Rewind.

NOTE

- Only tapes that are missing the Record Safety Tab (including most rented movies) will play automatically when inserted.

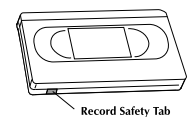

Follow these steps to dim the front panel display.

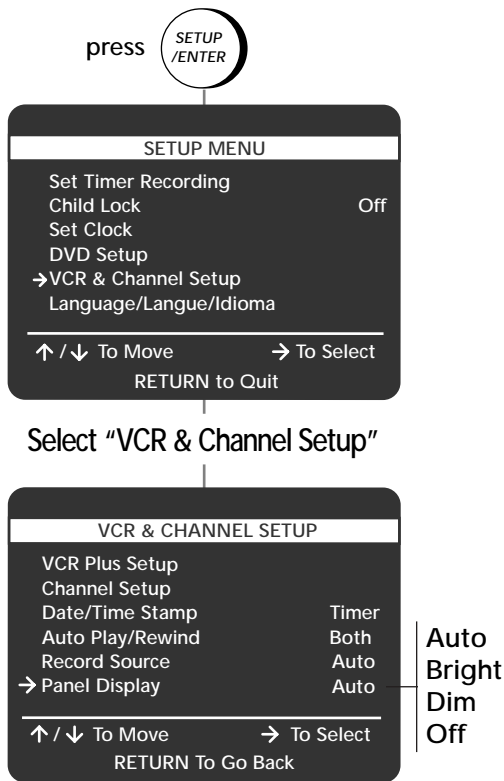

1 OPEN "SETUP MENU"

Press SETUP/ENTER.

2 SELECT "VCR & CHANNEL SETUP"

Use the UP/DOWN arrow keys to move the pointer to "VCR & Channel Setup," then press the RIGHT arrow key to select.

3 SET "PANEL DISPLAY"

Use the UP/DOWN arrow keys to move the pointer to "Panel Display," then press the RIGHT arrow key to select from the following:

Auto – The front panel display will dim between the hours of 10:00 p.m. and 6:00 a.m. It will also dim automatically during DVD playback.

Bright – The front panel display will be bright at all times.

Dim – The front panel display will be dim at all times.

Off – The front panel display will be off at all times.

ADVANCED DVD SETUP

This Chapter presents advanced DVD setup options, including Aspect Ratio, Language Preferences, Dynamic Compression, Rating Control, Still Mode and Black Level.

Follow these steps to set the TV Aspect Ratio so the DVD player will display movies at the appropriate size for your television.

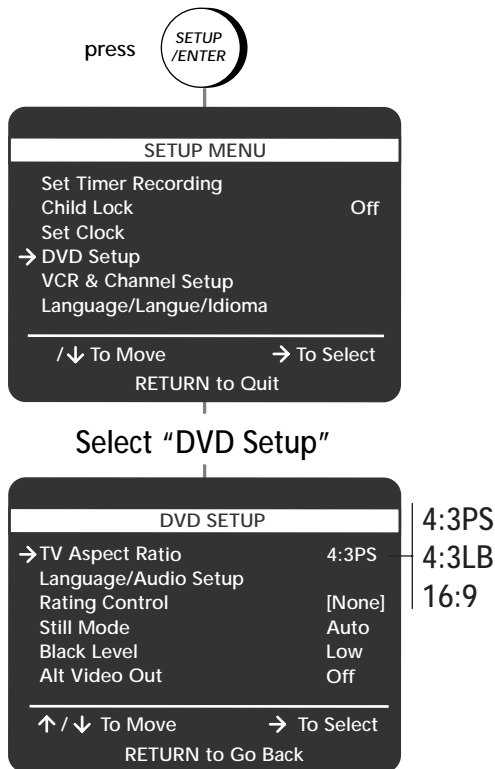

1 OPEN "SETUP MENU"

Press SETUP/ENTER.

- Make sure the DVD deck is stopped before pressing SETUP/ENTER. You will not be able to enter the "DVD Setup" menu if a DVD is playing.

2 SELECT "DVD SETUP"

Use the UP/DOWN arrow keys to select "DVD Setup," then press the RIGHT arrow key to select.

3 SET "TV ASPECT RATIO"

Use the UP/DOWN arrow keys to move the pointer to "TV Aspect Ratio," then press the RIGHT arrow key to select from the following:

- **4:3PS** - 4:3 Pan and Scan. The familiar way of watching VHS movies, this method selectively crops wide screen movies (by panning and scanning to keep the most important part of the picture visible) to fit a standard 4:3 television screen.
- **4:3LB** - Letterbox. This method displays the full width of the widescreen movie on a standard 4:3 television. As a result, black bars will appear at the top and bottom of the screen.
- **16:9** - Widescreen. This method allows you to view the full picture on a 16:9 widescreen television.



Follow these steps to choose the default language for DVD audio soundtracks, subtitles and disc menus.

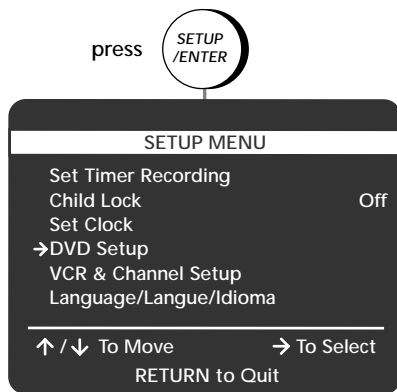

Select "DVD Setup"



Select "Language/Audio Setup"

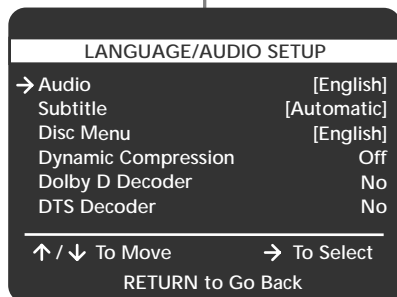

Select "Audio,"



"Subtitle,"

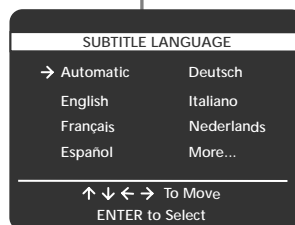

or "Disc Menu"



1 OPEN "SETUP MENU"

Press SETUP/ENTER.

- Make sure the DVD deck is stopped before pressing SETUP/ENTER. You will not be able to enter the "DVD Setup" menu if a DVD is playing.

2 SELECT "DVD SETUP"

Use the UP/DOWN arrow keys to move the pointer to "DVD Setup," then press the RIGHT arrow key to select.

3 SELECT "LANGUAGE/AUDIO SETUP"

Use the UP/DOWN arrow keys to move the pointer to "Language/Audio Setup," then press the RIGHT arrow key to select.

4 SET LANGUAGE PREFERENCES

Use the UP/DOWN/LEFT/RIGHT arrow keys to select and set the following:

Audio

Select your preferred language for DVD audio soundtracks, then press SETUP/ENTER.

Subtitle

Select your preferred language for DVD subtitles, then press SETUP/ENTER.

Disc Menu

Select your preferred language for DVD disc menus, then press SETUP/ENTER.

- Available languages vary from disc to disc. The disc itself may override your selection.

NOTES

- If you select "Original" on the "Audio Language" menu, the disc's default language will be selected.
- If you select "Automatic" on the "Subtitle" menu, the disc's default subtitle language will be selected.

Dynamic Compression constrains the dynamic range of a DVD soundtrack; i.e., the difference between the quietest and loudest passages.

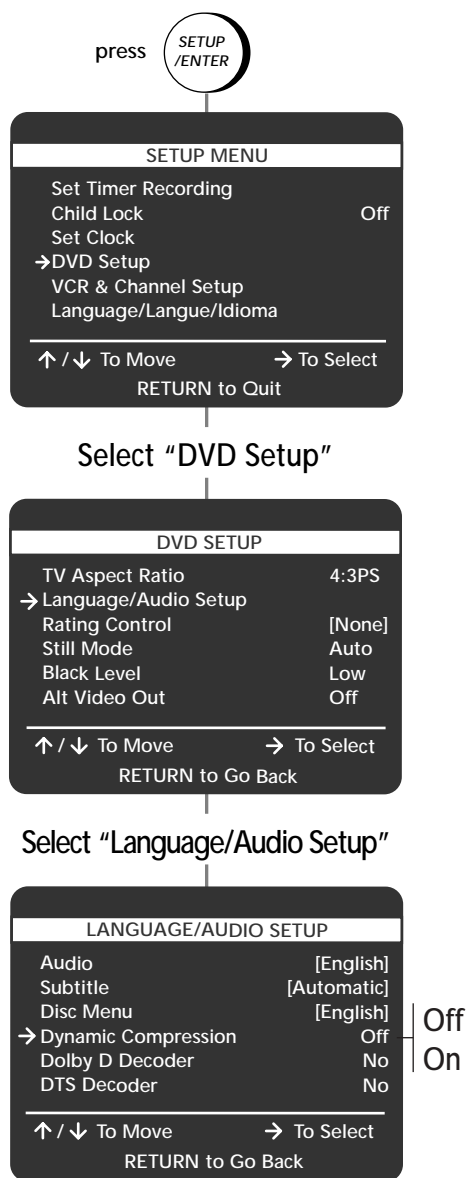

1 OPEN "SETUP MENU"

Press SETUP/ENTER.

- Make sure the DVD deck is stopped before pressing SETUP/ENTER. You will not be able to enter the "DVD Setup" menu if a DVD is playing.

2 SELECT "DVD SETUP"

Use the UP/DOWN arrow keys to move the pointer to "DVD Setup," then press the RIGHT arrow key to select.

3 SELECT "LANGUAGE/AUDIO SETUP"

Use the UP/DOWN arrow keys to move the pointer to "Language/Audio Setup," then press the RIGHT arrow key to select.

4 SET "DYNAMIC COMPRESSION"

Use the UP/DOWN arrow keys to move the pointer to "Dynamic Compression," then press the RIGHT arrow key to select from the following:

- **On** - The total dynamic range of the DVD soundtrack will be compressed, so quiet passages will be louder and loud passages will be softer. This is convenient for watching movies late at night, or whenever you want to constrain the volume to a steady level.
- **Off** - The original dynamic range will be preserved.



Follow these directions to set up a Rating Control system to prohibit playback of certain DVD movies.



Select "DVD Setup"

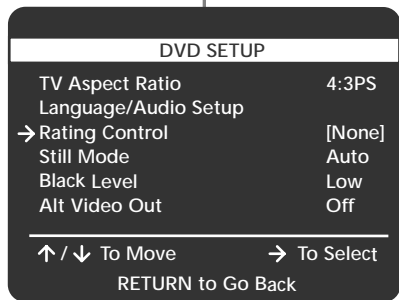

Select "Rating Control"

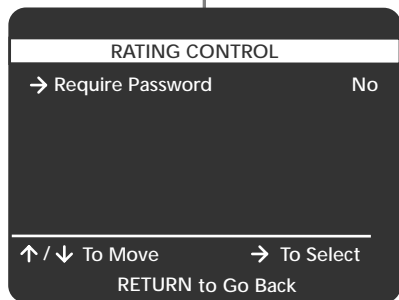

Set "Require Password" to "Yes"

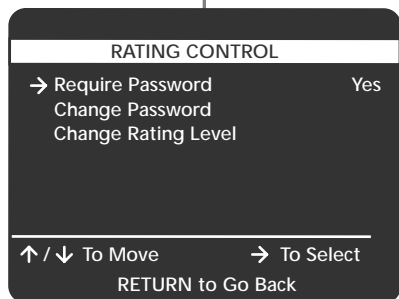

1 OPEN "SETUP MENU"

Press SETUP/ENTER.

- Make sure the DVD deck is stopped before pressing SETUP/ENTER. You will not be able to enter the "DVD Setup" menu if a DVD is playing.

2 SELECT "DVD SETUP"

Use the UP/DOWN arrow keys to move the pointer to "DVD Setup," then press the RIGHT arrow key to select.

3 SELECT "RATING CONTROL"

Use the UP/DOWN arrow keys to move the pointer to "Rating Control," then press the RIGHT arrow key to select. The current status of "Rating Control" is indicated in brackets; e.g. "[None]" or "[L8]":

- If Rating Control is currently set to "[None]," continue with Step 4.
- If Rating Control is already set to a Rating Level, you will be prompted to enter your existing password. Enter the password, then continue with Step 4.

4 SET "REQUIRE PASSWORD"

Press the RIGHT arrow key to set "Require Password":

- **No** – Select "No" if you do not want to use the Rating Control system; i.e., no password will be required to view any DVD.
- **Yes** – Select "Yes" if you want to use the Rating Control system; i.e., a password will be required to view DVDs at or above a particular rating. "Change Password" and "Change Rating Level" will appear on the "Rating Control" menu when Require Password is set to "Yes."

5 CHANGE PASSWORD OR RATING LEVEL

From here, you can choose either to:

- Set or change the Rating Control password; see page 55.
- OR
- Set or change the Rating Level; see page 56.

Follow these instructions to set or change the rating control password.

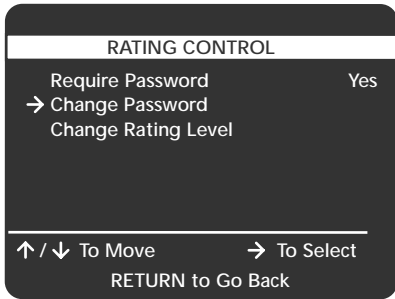

Select "Change Password"



press 0 — 9 to enter new password



press 0 — 9 to re-enter new password



1 SELECT "CHANGE PASSWORD"

From the "Rating Control" menu, use the UP/DOWN arrow keys move the pointer to "Change Password," then press the RIGHT arrow key to select.

2 ENTER NEW PASSWORD

Use the 0-9 keys on the remote control to enter a new 4-digit password.

- Remember to write down your password and store it in a safe place!

3 RE-ENTER PASSWORD

Use the 0-9 keys on the remote control to re-enter the same 4-digit password.

4 CONFIRM NEW PASSWORD

After you re-enter the password, a menu will appear to indicate whether or not the password has been successfully changed. Press RETURN to continue.

- To set the Rating Level, see page 56.
- To exit the menu system, press RETURN repeatedly.



Follow these instructions to prohibit viewing of DVDs at or above a particular rating.

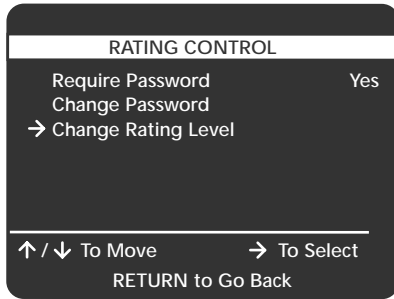

Select "Change Rating Level"

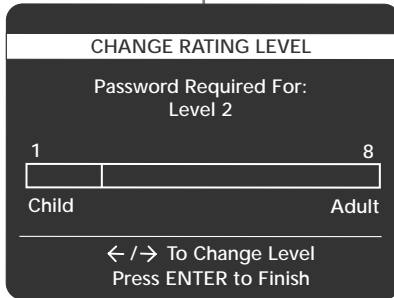

1 SELECT "CHANGE RATING LEVEL"

From the "Rating Control" menu, use the UP/DOWN arrow keys to move the pointer to "Change Rating Level," then press the RIGHT arrow key to select.

2 CHANGE RATING LEVEL

Use the LEFT/RIGHT arrow keys to select from the following:

- Level 1 (G)
- Level 2
- Level 3 (PG)
- Level 4 (PG-13)
- Level 5
- Level 6 (R)
- Level 7 (NC-17)
- Level 8

3 CONFIRM RATING LEVEL

Press SETUP/ENTER to confirm your rating level.

- To exit the menu system, press RETURN repeatedly.

NOTES

- Not all DVDs are rated.
- DVDs that are rated at or higher than the level you select will not play without entering the password you set.

Follow these steps to set Still Mode (the method used to freeze a single image) and Black Level (the reference level for black in the video signal).

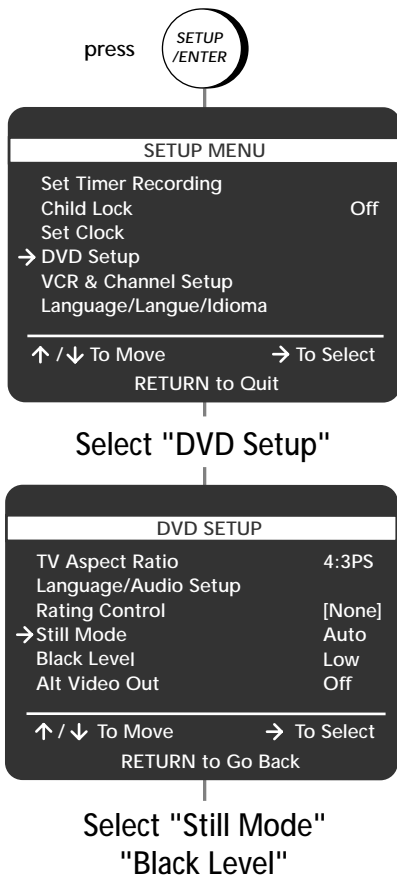

1 OPEN "SETUP MENU"

Press SETUP/ENTER.

- Make sure the DVD deck is stopped before pressing SETUP/ENTER. You will not be able to enter the "DVD Setup" menu if a DVD is playing.

2 SELECT "DVD SETUP"

Use the UP/DOWN arrow keys to select "DVD Setup," then press the RIGHT arrow key to select.

3 SET "STILL MODE/BLACK LEVEL"

Use the UP/DOWN arrow keys to select and set the following:

Still Mode

Auto – Selects "Still Mode" automatically by detecting motion in the scene.

Frame – Select if you want to see fine text more clearly than in Auto mode.

Field – Select if the screen shakes in Auto mode.

Black Level

High – Selects standard NTSC reference black level for consistent brightness/contrast across all sources.

Low – Selects enhanced black level for increased contrast when viewing DVDs.

D

HELP

This Chapter provides customer support information, as well as a list of FAQs, technical specifications, the product warranty and a special feature summary.

The chart below will help you solve common challenges with your DVD+VCR. If you don't find the answers you need here, you can contact our Customer Service Department as follows:

Phone: (480) 922-0896
E-Mail: "dvdhelp@sonicblue.com"
Web: "www.govideo.com" or
 "www.sonicblue.com"

SYMPTOM	SOLUTION(S)
Cannot access Setup menu.	<ul style="list-style-type: none"> Stop the DVD player. You cannot access the Setup menu while a disc is playing.
No sound from speakers.	<ul style="list-style-type: none"> Connect the DVD+VCR to a Dolby Digital-ready amplifier. You cannot connect speakers directly to the analog audio outputs because the unit does not have a built-in amplifier. Dolby Digital and/or DTS not enabled in the menu system; see page 39.
TV only shows Go-Video screen.	<ul style="list-style-type: none"> Connect the Composite and S-Video outputs to separate inputs on your television. If your television has one set of inputs for both S-Video and Composite, then the S-Video will most likely override the Composite input.
Cannot play other regional DVDs.	<ul style="list-style-type: none"> The DVD-VCR will play Region 1 encoded discs only.
Cannot record on DVD deck.	<ul style="list-style-type: none"> The DVD deck does not allow recording.
Can I connect to surround sound system?	<ul style="list-style-type: none"> Yes, you can connect the DVD+VCR to an audio/video receiver or amplifier using the coaxial or optical digital outputs or analog outputs.
What types of discs can I play?	<ul style="list-style-type: none"> DVD Video, CD Digital Audio, CD Video, SVCD and CD-ROM with MP3 tracks.
Picture has black bars.	<ul style="list-style-type: none"> Make sure your TV Aspect Ratio is set properly to 4:3 or 16:9; see page 51. Aspect ratios vary from disc to disc. The specific DVD may not offer a 4:3 full-screen version.
Auto Setup did not find all channels.	<ul style="list-style-type: none"> If a cable box/satellite receiver is connected, the DVD+VCR will only find the cable box output channel. Use the alternative cable box hookup on page 42.
No picture.	<ul style="list-style-type: none"> Press TV/VCR until the VCR indicator lights on the front panel display. Set Channel Switch to channel 4.

Poor picture quality on VCR.	<ul style="list-style-type: none"> • Set Channel Switch to channel 4. • Adjust tracking with AUTO and TRK -/+ keys. • Clean video heads with nonabrasive head cleaning tape.
Remote not working.	<ul style="list-style-type: none"> • Remove all obstacles and point directly at DVD+VCR. • Make sure batteries are fresh and properly installed. • Press DVD or VCR key. Note: If you press DVD key by accident, remote will only operate the DVD player. The same is true of the VCR key.
On-screen display shows "Error."	<ul style="list-style-type: none"> • Turn power off, then turn power on again. • Inspect tape/disc slots for foreign objects.
VCR doesn't work.	<ul style="list-style-type: none"> • Unplug DVD+VCR for 10 seconds, then plug it in again. • If still doesn't work, unplug DVD+VCR overnight (at least 6 hours), then plug it in again. Note: If the clock is still set, you haven't unplugged it long enough. • If still doesn't work, DVD+VCR must be serviced by an authorized service center.
Cannot record from cable box.	<ul style="list-style-type: none"> • Set DVD+VCR to cable box output channel 2, 3 or 4, then select desired channel on cable box.
Cannot Timer Record.	<ul style="list-style-type: none"> • Set clock to correct time.
Tape ejects during copy or record.	<ul style="list-style-type: none"> • Place piece of tape over record safety tab opening.
VCR automatically plays and rewinds.	<ul style="list-style-type: none"> • To turn Auto Play/Rewind off; see page 49.
Tape counters not moving on VCR deck.	<ul style="list-style-type: none"> • To display tape counters, the VCR deck requires control track, which is only present on prerecorded tapes.
No menu or On-Screen Displays.	<ul style="list-style-type: none"> • Tape may be blank ("snow" appears on screen). If so, menus and On-Screen Display cannot be shown. Stop tape or record on tape to enable displays.
TV shows blue screen.	<ul style="list-style-type: none"> • If current channel is too weak to display clear picture, DVD+VCR will display blue screen. • Double-check antenna connections or tuner settings.
Power button blinking.	<ul style="list-style-type: none"> • DVD+VCR is in Auto Power Off mode. If you press POWER while rewinding, copying, Timer Recording or One-Touch Recording, DVD+VCR will automatically turn off when the given function is complete. • Press POWER to toggle Auto Power on and off.
No stereo sound.	<ul style="list-style-type: none"> • Connect TV and DVD+VCR with RCA line cables. If your TV and DVD+VCR are connected with an RF coaxial cable, you will only hear stereo sound if the DVD+VCR is turned off.



The following are the technical specifications for your DVD+VCR.

INPUTS		
AUDIO		2 Stereo audio inputs, RCA Connector, -8dbm, 47K Ω , front and rear
VIDEO		2 Composite video inputs, RCA Connector, 75 Ω , 1Vp-p
RF		Antenna or CATV Input, F-Connector, 75 Ω – Ch 2-69, CATV Ch 1-125
OUTPUTS		
AUDIO		2 Stereo audio outputs, RCA Connector, -8dbm, 1.5k Ω
VIDEO		DVD+VCR: 1 Composite video output, RCA Connector, 75 Ω , 1Vp-p
		DVD only: 1 S-Video output, S-Connector, 75 Ω , Y = 1.0Vp-p, C = 0.286Vp-p
		DVD only: 1 Component video output, 75 Ω , Y = 1.0Vp-p, Pb = 0.7Vp-p, Pr = 0.7Vp-p
RF		Channel 3 or 4
VCR SPECIFICATIONS		
VIDEO SYSTEM		1/2-inch VHS system, 4 rotary head helical scanning; FM azimuth luminance; chrominance: converted sub system phase shift
AUDIO TRACK		Normal: 1 track; Hi-Fi: 2 track
PLAY/RECORD TIME		T-180 tape: SP 3 hours, SLP 9 hours
FF/REW TIME		T-120 tape: <2 minutes
HEADS		
Video:		DA 4 rotary
Audio:		2 rotary heads (Hi-Fi); 1 stationary head (Linear)
Control:		1 stationary head
Erase:		1 full track, 1 audio track
WOW & FLUTTER		Less than 0.005% (Hi-Fi)
FREQ. RESPONSE		20-20,000 Hz (Hi-Fi)
DVD SPECIFICATIONS		
DISC COMPATIBILITY		DVD-Video, CD-Digital Audio (5" and 3.5"), CD-Video, SVCD, CD-R
		Not compatible with CD-R/W
FREQ. RESPONSE		96/48 kHz Sampling: 4 Hz-22kHz
S/N RATIO		110 dB
DYNAMIC RANGE		96 dB
THD		0.003 %
SYSTEM SPECIFICATIONS		
POWER REQUIREMENT		120V AC, 60 Hz, 27 watts
CLOCK BACKUP TIME		~6 hours
ENVIRONMENT		41-104 F (5-40 C); 10%-75% humidity
UNIT WEIGHT		11.6 lbs.
UNIT DIMENSIONS		17in. X 14in. X 4in.



90 days labor
1 year parts

Who Provides the Limited Warranty

During the warranty period, the Go-Video Warranty Administrator will honor DVD+VCR service for 90 days labor, 1 year parts from the original date of consumer purchase. See below for Commercial, Industrial or Educational use coverage. The DVD+VCR remote control is warranted for 90 days from the date of purchase.

Who is Protected

This warranty protects the original consumer owner of this Go-Video product.

What is Covered and How Long

This warranty covers internal operating parts and service/labor to repair or replace covered parts in this Go-Video product for 90 days labor, 1 year parts, from the date of purchase, defined as follows: (1) Original Consumer Retail Purchase; (2) First Rental Purchase Agreement; or (3) First Lease Purchase Agreement (the "Warranty Period"). Labor and replacement parts supplied during the Warranty Period are covered only for the remaining portion of the original Warranty Period. The Go-Video Warranty Administrator shall have no liability for service under this warranty if non-OEM (Original Equipment Manufacturer) replacement parts are used in the repair of your Go-Video product.

What the Owner Must Do If Service is Required

If service under this warranty is required, contact the Go-Video Warranty Administrator at (480) 922-0896 to determine the nearest authorized Go-Video service center.

What are the Exceptions

This warranty does not cover: (1) Normal maintenance service, such as video head cleaning. (2) Damage from misuse, abuse neglect or accident, natural disasters or Acts of God. (3) Cabinetry, decorative parts, A/C adapters, knobs or buttons. (4) The foreign country use of this product. (5) Go-Video product which has been electronically or mechanically modified in any way or incorporated into other products. (6) Installation and setup service adjustments. (7) Owner instruction. Your Owner's Guide provides information regarding operating instructions and user controls. For additional information, contact your authorized Go-Video dealer.

- Go Video is not responsible for any shipping, handling or insurance charges.
- This Exclusive Limited Warranty excludes all incidental and consequential damages. Some states do not allow the exclusion of incidental and consequential damages, so the above exclusion may not apply to you.
- ALL IMPLIED WARRANTIES, INCLUDING IMPLIED WARRANTIES OF MERCHANTABILITY AND FITNESS FOR A PARTICULAR PURPOSE ARE LIMITED IN DURATION TO THE DURATION OF THIS WARRANTY PERIOD. Some states do not allow limitations on how long an implied warranty lasts, so the above limitation may not apply to you.
- This Exclusive Limited Warranty gives you specific legal rights and you may also have other rights which vary from state to state.

Go-Video Warranty Administrator

SONICblue Corporation
7835 East McClain Drive
Scottsdale, Arizona 85260-1732
(480) 922-0896
customerservice@sonicblue.com

Enjoy the following features of your DVD+VCR.

SYSTEM FEATURES

- Complete versatility to play DVDs, VCDs, audio CDs, CD-Rs or VHS Tapes
- Watch a DVD while recording a TV show with the VCR
- Auto Setup automatically sets clock and searches for channels
- A/V switching between TV, VCR and DVD deck with TV view button for ease of use
- Multi-brand remote with glow-in-the-dark keys controls both DVD and VCR decks
- Composite, S-Video and Component video outputs for high connectivity and optimum performance
- RF inputs and outputs for connection to all TVs—new or old
- Child Lock to protect children from tampering with DVD+VCR
- English/French/Spanish on-screen programming
- Records from DVD to VHS (unless DVD is copy protected with Macrovision®)
- Auto Head Cleaners

DVD FEATURES

- 10-bit video digital to analog converter and 27MHz advanced digital filter
- Playback of 96KHz/24-bit sources
- Dolby Digital® output
- DTS digital output for DTS-enhanced DVDs
- Playback MP3 files from CD-ROM
- Compatible with CD-R
- Continued audio during 2x speed playback

VCR FEATURES

- Hi-Fi Stereo VCR
- 4 heads for superior slow motion and stop action
- VCR Plus+™ programs your VCR in one easy step
- VISS Index Search/Scan, Zero Return, Direct Time Search, Blank Search
- 16-event/1 year timer recording
- Time remaining counter, real time counter



Symbols

0-9 5, 6
 100+ 5
 16:9 Widescreen 51
 3D Sound 6, 10, 17
 4:3 Letterbox 51
 4:3 Pan and Scan 51

A

A-B Repeat 18
 A/V Receiver 38
 Add/Remove Channel
 47
 Alt Video Out 37
 AM/PM 10, 45
 Angle 6, 10, 16
 Audio 6, 17, 38, 52
 Auto Channel Search
 3, 47
 Auto Clock Set 3, 44
 Auto Head Cleaners 62
 Auto Play 49
 Auto Rewind 49
 Auto Setup 3
 Auto Show Finder 34

B

Batteries, Insert 1
 Black Level 57
 Blank Search 35
 Bookmarks 19

C

Cable Box Record
 Source 26
 Channel
 +/- keys 9
 Settings 47
 Switch 11
 Channel Mapping 28
 Chapter
 Indicator 10
 Selecting 15
 Child Lock 48
 Clear key 7, 14
 Clock Set Channel 44
 Clock/Counter key 7
 Complete Program
 Record 26, 31
 Component Video Out
 11

Connections
 Advanced 36
 Alternative Cable
 Box 42
 Antenna 2
 Basic 2
 Cable Box 41
 Component 36
 Line Out 2
 Other A/V 40
 RF Antenna 2
 S-Video 36
 Stereo 38
 Copy
 DVD to VCR 24
 indicator 10
 key 9
 Customer Service 58

D

Date/Time Stamp
 23, 34
 Day 45
 Daylight Savings Time
 46
 Deck Status indicator
 10
 Digital Audio Out 11
 Direct Time Search 35
 Disc Menu 52
 Disc Menu key 6
 Disc Type indicator 10
 Display key 6, 7
 Dolby Digital Decoder
 39, 62
 Down Arrow key 14
 DTS 62
 DTS Decoder Setting
 39
 DVD Deck 8
 DVD Deck indicator 10
 DVD Display 15
 DVD Features 62
 DVD key 5
 DVD Language Prefer-
 ences 52
 DVD Playback 12
 DVD Status indicator
 10
 DVD-VHS key 8
 Dynamic Compression
 53

E

Event Number 25
 Event Summary 27, 30

F

Fast-Forward key 7, 8
 Feature Summary 62
 Field 57
 Flap Door 8, 9
 Frame 57
 Frame Advance 13
 Freeze 12, 13
 Front Panel 8
 Front Panel Dimmer 50
 Front Panel Display
 8, 10
 Front Panel Menu keys
 14

H

Help 58
 Hi-Fi indicator 10
 Hour 45

I

Index Marks
 Automatic 33
 Defined 33
 Manual 33
 Index Search/Scan 34
 Initial Setup 1

L

Language Settings
 3, 43
 LCV key 5
 Left Arrow key 14
 Line 1 Audio Input 9
 Line 1 Video Input 9
 Line In 2 11
 LPCM (Linear Pulse
 Code Modulation)
 10

M

Macrovision 62
 Mark key 6
 Menu Navigation 14
 Minute 45
 Mode/Repeat key 6, 7
 Mono 7
 Month 45



O

One-Touch Recording 22
Open/Close key 6, 7, 8
OTR 22
OTR Loop Record 22
Overlapping Events 27

P

Password 55, 56
Play/Pause key 6, 7, 8
Playback
 DVD 12
 VCR 13
PlusCode 2, 28, 30
Power key 5, 8
Programmed Playback 20

R

Random Playback 20
Rating Control 54
Rating Level 56
Rear Panel 11
Record key 7, 8
Record Safety Tab 25
Record Settings 23
Record Source 23, 26
Record Speed 22, 26, 31
Record Speed indicator 10
Recording, Basic 22
Remote Control 5
 Setup 4
Remove Channel 47
Repeat 13
Repeat Chapter/Title 18
Return key 6
Return to 0:00:00 35
Rewind key 7, 8
RF 2
RF Antenna Input 11
RF Out to TV 11
Right Arrow key 14

S

S-Video Out 11
Safety iii
SAP 7
Scan Index Marks 34
Search 12, 13
Search Features 33, 35
Search Index Marks 34
Search/Index key 7, 8
Setup key 9
Setup/Enter key 6, 7, 14
Show Weak Channels 47
Shuttle keys 7, 13
Skip 12
Skip/F.Adv key 6, 7
Skip/Search Back key 6, 8
Skip/Search Forward key 6, 8
Slow Motion 12
SLP 22, 26, 31
SP 22, 26, 31
SP/SLP key 7, 8
Stereo 7
Still Mode 57
Stop key 6, 7, 8
Subtitle 17, 52
Subtitle key 6
System/Deck Select keys 5

T

T-120 Tape 26, 31
Tape Missing 27
Tape Missing Tab 27
Technical Specifications 60
Time, Selecting 15
Time Zone 44
Timer Extend 32
Timer Record indicator 10
Timer Recording 25
Timer Recording Errors 27

Title

 Indicator 10
 Key 6
 Selecting 15
Tracking
 Automatic 7, 13
 Manual 7, 13
Troubleshooting 58
Tuner Audio 7
Tuner Band 47
TV Aspect Ratio 51
TV Mode 4
TV View key 5
TV+SAP 7
TV/VCR key 5, 9

U

Unpacking 1
Up Arrow key 14

V

VCR Deck 8
VCR Deck indicator 10
VCR Features 62
VCR key 5
VCR mode 4
VCR Plus+ key 7
VCR Plus+ Recording 28, 30
VCR Plus+ Worksheet 29
VCR Status indicator 10
Volume +/- keys 5, 9

W

Warranty 61
Weekly 26, 31

Y

Year 45

Z

Zoom 16
Zoom key 6

DVR 4550 MENU SYSTEM

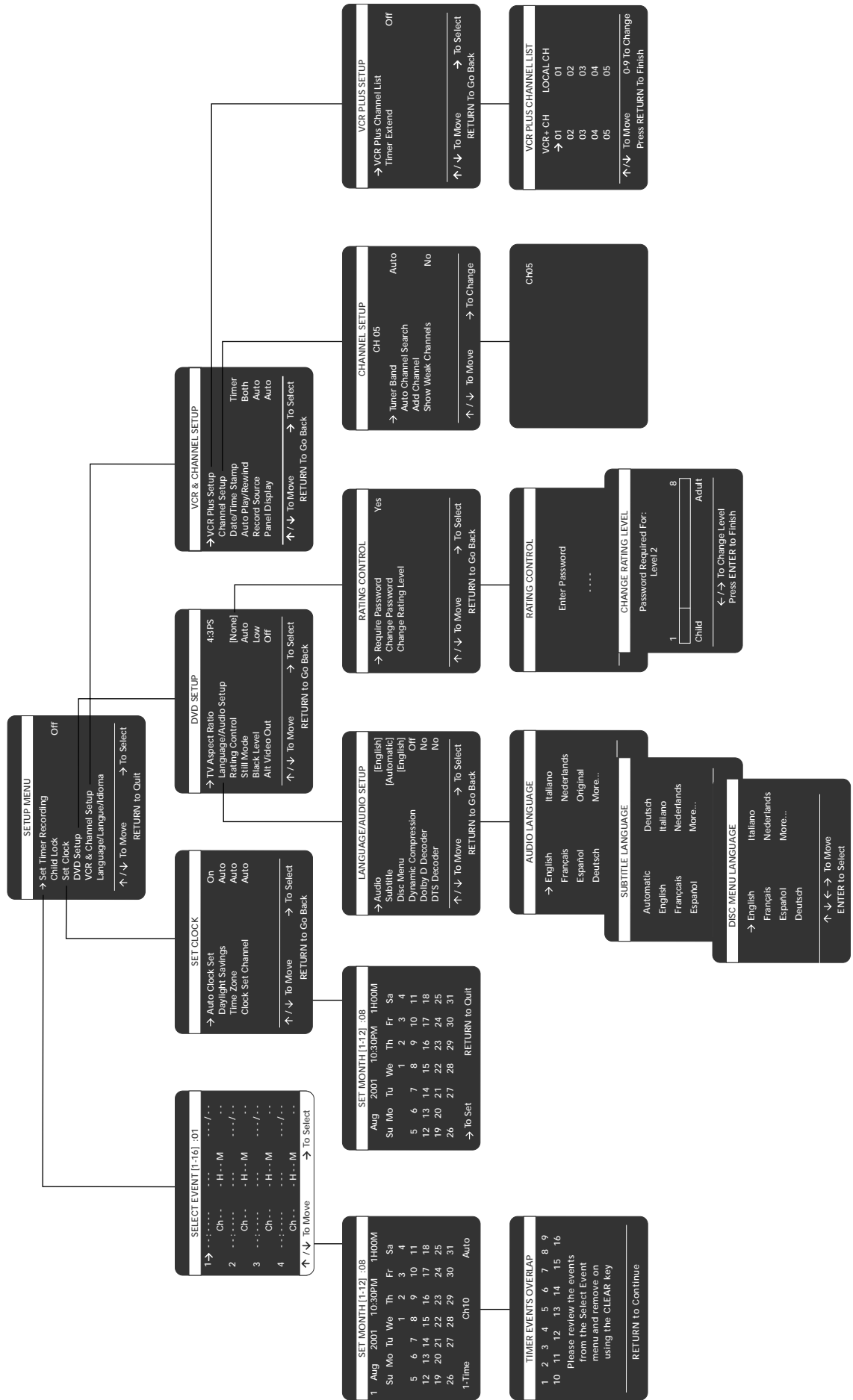

SONIC|blue™

7835 East McClain Drive
Scottsdale, AZ 85260 USA
www.sonicblue.com



Free Manuals Download Website

<http://myh66.com>

<http://usermanuals.us>

<http://www.somanuals.com>

<http://www.4manuals.cc>

<http://www.manual-lib.com>

<http://www.404manual.com>

<http://www.luxmanual.com>

<http://aubethermostatmanual.com>

Golf course search by state

<http://golfingnear.com>

Email search by domain

<http://emailbydomain.com>

Auto manuals search

<http://auto.somanuals.com>

TV manuals search

<http://tv.somanuals.com>