



DVD Recorder+VCR



VR4940 User Manual



Safety Precautions



CAUTION
RISK OF ELECTRIC SHOCK
DO NOT OPEN



CAUTION: TO REDUCE THE RISK OF ELECTRIC SHOCK DO NOT REMOVE COVER (OR BACK). NO USER-SERVICEABLE PARTS INSIDE REFER SERVICING TO QUALIFIED SERVICE PERSONNEL.



The lightning flash with arrowhead symbol within an equilateral triangle is intended to alert the user to the presence of uninsulated dangerous voltage within the product's enclosure that may be of sufficient magnitude to constitute a risk of electric shock to persons.



The exclamation point within an equilateral triangle is intended to alert the user to the presence of important operating and maintenance (servicing) instructions in the literature accompanying the product.

WARNING: TO REDUCE THE RISK OF FIRE OR ELECTRIC SHOCK, DO NOT EXPOSE THIS APPARATUS TO RAIN OR MOISTURE.

CAUTION: TO PREVENT ELECTRIC SHOCK, MATCH WIDE BLADE OF PLUG TO WIDE SLOT, FULLY INSERT.

ATTENTION: POUR ÉVITER LES CHOC ÉLECTRIQUES, INTRODUIRE LA LAME LA PLUS LARGE DE LA FICHE DANS LA BORNE CORRESPONDANTE DE LA PRISE ET POUSSER JUSQU'AU FOND.

WARNING: Do not install this equipment in a confined space such as a bookcase or similar unit.

NOTE TO CABLE/TV INSTALLER: This reminder is provided to call the cable TV system installer's attention to Article 820-40 of the National Electric Code (U.S.A.). The code provides guidelines for proper grounding and, in particular, specifies that the cable ground shall be connected to the grounding system of the building, as close to the point of the cable entry as practical.

CAUTION:

This DVD Recorder+VCR employs a Laser System.

To ensure proper use of this product, please read this owner's manual carefully and retain for future reference.

Should the DVD Recorder+VCR require maintenance, contact an authorized service center.

Use of controls, adjustments, or the performance of procedures other than those specified herein may result in hazardous radiation exposure.

To prevent direct exposure to laser beam, do not try to open the enclosure. Visible laser radiation when open. DO NOT STARE INTO BEAM.

CLASS 1 LASER PRODUCT
KLASSE 1 LASER PRODUKT
LUOKAN 1 LASER LAITE
KLASS 1 LASER APPARAT
CLASSE 1 PRODUIT LASER

CAUTION: The apparatus should not be exposed to water (dripping or splashing) and no objects filled with liquids, such as vases, should be placed on the apparatus.

FCC WARNING: This equipment may generate or use radio frequency energy. Changes or modifications to this equipment may cause harmful interference unless the modifications are expressly approved in the instruction manual. The user could lose the authority to operate this equipment if an unauthorized change or modification is made.

REGULATORY INFORMATION: FCC Part 15

This product has been tested and found to comply with the limits for a Class B digital device, pursuant to Part 15 of the FCC Rules. These limits are designed to provide reasonable protection against harmful interference when the product is operated in a residential installation. This product generates, uses, and can radiate radio frequency energy and, if not installed and used in accordance with the instruction manual, may cause harmful interference to radio communications. However, there is no guarantee that interference will not occur in a particular installation. If this product does cause harmful interference to radio or television reception, which can be determined by turning the product off and on, the user is encouraged to try to correct the interference by one or more of the following measures:

- Reorient or relocate the receiving antenna.
- Increase the separation between the product and receiver.
- Connect the product into an outlet on a circuit different from that to which the receiver is connected.
- Consult the dealer or an experienced radio/TV technician for help.

FCC COMPLIANCE: The responsible party for this product's compliance is: GoVideo, 7835 East McClain Drive, Scottsdale, AZ 85260, USA.

SERIAL NUMBER: The serial number is found on the back of the DVD Recorder+VCR. This number is for this unit only. You should record requested information here and retain this guide as a permanent record of your purchase.

Model No. _____

Serial No. _____

IMPORTANT SAFETY INSTRUCTIONS

CAUTION: PLEASE READ AND OBSERVE ALL WARNINGS AND INSTRUCTIONS IN THIS OWNER'S MANUAL AND THOSE MARKED ON THE PRODUCT. RETAIN THIS MANUAL FOR FUTURE REFERENCE.

This product has been designed and manufactured to assure personal safety. Improper use can result in electric shock or fire hazard. The safeguards incorporated in this product will protect you if you observe the following procedures for installation, use, and servicing.

This product does not contain any parts that can be repaired by the user.

DO NOT REMOVE THE CABINET COVER, OR YOU MAY BE EXPOSED TO DANGEROUS VOLTAGE. REFER SERVICING TO QUALIFIED SERVICE PERSONNEL ONLY.

- 1. Read these instructions.** - All these safety and operating instructions should be read before the product is operated.
- 2. Keep these instructions.** - The safety, operating and use instructions should be retained for future reference.
- 3. Heed all warnings.** - All warnings on the product and in the operating instructions should be adhered to.
- 4. Follow all instructions.** - All operating and use instructions should be followed.
- 5. Do not use this product near water.** - For example: near a bath tub, wash bowl, kitchen sink, laundry tub, in a wet basement; or near a swimming pool; and other areas located near water.
- 6. Clean only with dry cloth.** - Unplug this product from the wall outlet before cleaning. Do not use liquid cleaners.
- 7. Do not block any ventilation openings. Install in accordance with the manufacturer's instructions.** - Slots and openings in the cabinet are provided for ventilation and to ensure reliable operation of the product and to protect it from overheating. The openings should never be blocked by placing the product on a bed, sofa, rug or other similar surface. This product should not be placed in a built-in installation such as a bookcase or rack unless proper ventilation is provided or the manufacturer's instructions have been adhered to.
- 8. Do not install near any heat sources such as radiators, heat registers, stoves, or other apparatuses (including amplifiers) that produce heat.**
- 9. Do not defeat the safety purpose of the polarized or grounding-type plug.** A polarized plug has two blades with one wider than the other. A grounding type plug has two blades and a third grounding prong. The wide blade or the third prong are provided for your safety. If the provided plug does not fit into your outlet, consult an electrician for replacement of the obsolete outlet.
- 10. Protect the power cord from being walked on or pinched particularly at plugs, convenience receptacles, and the point where they exit from the product.**
- 11. Only use attachments/accessories specified by the manufacturer.**
- 12. Use only with the cart, stand, tripod, bracket, or table specified by the manufacturer, or sold with apparatus. When a cart is used, use caution when moving the cart/product combination to avoid injury from tip-over.**
- 13. Unplug this product during lightning storms or when unused for long periods of time.**
- 14. Refer all servicing to qualified service personnel. Servicing is required when the product has been damaged in any way, such as: Power-supply cord or plug is damaged; liquid has been spilled or objects have fallen into the product; the product has been exposed to rain or moisture, does not operate normally, or has been dropped.**



Table of Contents

INTRODUCTION

VR4940 Overview	6-9
Recordable Discs	6
Playable Discs	6
Disc-related Terms	6
Types of video CDs	6
About DVD-R and DVD-RW Discs	7
What are 'Recording Modes'?	7
• Is Editing a DVD like Editing a Videotape? ..	7
• "Original" Content vs "Playlist" Content ..	7
About DVD Recording	7-8
• Disc Types and Recording Formats	7
• Notes for Recording	8
• Recording TV Audio Channels	8
• Restrictions on Video Recording	8
• What is 'CPRM'?	8
• Copyright Notice	8
Precautions	9
• Handling the Unit	9
• Cleaning the Unit	9
• Remote Control Operating Range	9
• Remote Control Battery Installation	9
Notes on Discs	9
• Handling Discs	9
• Storing Discs	9
• Cleaning Discs	9
About Symbols	9
• About the  Symbol	9
• Symbols Used in this Manual	9
Front Panel Overview	10
Front Panel Display Overview	11
Remote Control Overview	12
Rear Panel Overview	13

CONNECTIONS & SETUP

Connections	14-17
Connecting Antenna/Cable	14
Connecting a TV	15
Connecting an Amplifier/Receiver	16
Connecting Optional Equipment	17
Connecting a Digital Camcorder	17
Initial Setup	18-29
Setup Menu Overview	18
Setup Menu Navigation	18
GENERAL Settings	18-20
• Tuning Band	18
• Auto Channel Set	18
• Channel Add/Delete	19
• Clock (Auto)	19
• Clock (Manual)	19
• TV Aspect Ratio	20
• Progressive Scan	20
• Factory Setting	20
LANGUAGE Settings	20
• Display Menu Language	20
• DISC Menu/Audio/Subtitle Language ..	20
AUDIO Settings	21
• Dolby Digital	21
• DTS	21
• MPEG	21
• Sampling Frequency	21
• DRC (Dynamic Range Control)	21
• Surround	21
LOCK Settings	22-23
• Movie Rating	22
• Password	22
• Country Code	23
RECORD Settings	23-24
• DISC Record Mode	23
• VCR Record Mode	23
• DV Record Audio	24
• Auto Chapter	24
DISC Settings	24-26
• DISC Initialize	24
• DISC Finalize	25
• DISC Protect	25
• PBC	25
• EZ Play	25
• My DVD	26
• DISC Name	26
On-Screen Display Overview	27
• Displaying Disc Information	27
• Displaying TV Information	27
• Changing TV Channels	27
• Changing TV Audio Channel	27
OSD Menu Options by Media Type	28-29
• DVD	28
• VR	28
• Video	29
• VHS	29

Table of Contents

PLAYBACK

DVD and Video CD Playback	30-33
Playing a DVD or Video CD	30
• Selecting Titles	30
• Selecting Chapters	30
• Slow Motion	30
• Still Picture and Frame-by-Frame Playback	31
• Search	31
• Random	31
• Repeat	31
• Repeat A-B	31
• Time Search	32
• Zoom	32
• Marker Search	32
• Disc Menus	32
• Title Menus	32
• Camera Angle	33
• Changing the Audio Language	33
• 3D Surround	33
• Subtitles	33
• Remember Disc Settings	33
Audio CD and MP3 Operation	34-35
Playing an Audio CD or MP3 Disc	34
Notes on MP3 Recordings	34
• Pause	35
• Skip Tracks	35
• Repeat	35
• Random	35
• Search	35
• Repeat A-B	35
Program Playback with Audio CD and MP3	36
Viewing a JPEG Disc	37
• Skip Images	37
• Rotate Images	37
• View Slide Shows	37
• Notes on JPEG Recordings	37
VCR Playback	
Before You Begin	38
Playing a VHS Tape	38
Tracking Control	38
Special Playback Features	38
• Search	38
• Still Picture and Frame-by-Frame Playback	38
• Slow Motion	38
• Counter Memory Function	38

RECORDING

Basic Recording	39-40
Recording from TV	39
One Touch Record (OTR)	39
One Touch Copy - DVD to VHS	40
One Touch Copy - VHS to DVD	40
Timer Recording	41
Checking Timer Recording Details	41
Canceling a Timer Recording	41
Stopping a Timer Recording in Progress	41
Timer Recording Troubleshooting	41
Recording from an External Input	42-43
Recording from External Components	42
Recording from a Digital Camcorder	42
Playing Recordings on other DVD Players	42
• Finalizing a Disc	42
What is DV?	43
• DV-Related Messages	43
• Troubleshooting	43



EDITING

VR Mode: Original and Playlist Editing	44-50
Titles and Chapters	44
Adding Chapter Markers	44
Changing Title or Chapter Thumbnails	44
Using the Original (Title) Menu	45
Using the Original (Chapter) Menu	45
Using the Playlist (Title) Menu	46
Using the Playlist (Chapter) Menu	46
Naming a Title	47
Making a New Playlist	47
Erasing an Original or Playlist Title/Chapter	48
Adding Titles/Chapters to the Playlist	48
Combining Two Chapters Into One	49
Moving a Playlist Chapter	49
Deleting a Part	50
Video Mode: Original editing	51
Using the Title List	51
Erasing a Title	51
If the Disc Has Already Been Finalized	51

REFERENCE

Programming the MultiBrand Remote to Control Your TV	52
Language Code List	53
Country Code List	54
Troubleshooting	55-56
Technical Specifications	57-58
Limited Warranty	59

Symbols Used in this Manual

-  Indicates hazards likely to cause harm to the unit itself or other material damage.
-  Indicates special operating features of the DVD Recorder+VCR.
-  Indicates helpful tips and hints.

VR4940 Overview

Recordable Discs

When you buy recordable discs, look for products with the following logos:

 12cm/8cm, single-sided, single layer disc.
Approx. max. recording time (LP mode):
240 minutes (4.7GB), 80 minutes (1.46GB)

 12cm/8cm, single-sided, single layer disc.
Approx. max. recording time (LP mode):
240 minutes (4.7GB), 80 minutes (1.46GB)

Notes

- The DVD Recorder+VCR cannot record on DVD+R, DVD+RW, CD-R or CD-RW discs.
- DVD-R/RW and CD-R/RW discs recorded using a personal computer or a DVD or CD recorder may not play if the disc is damaged or dirty, or if there is dirt or condensation on the DVD Recorder+VCR's lens.
- If you record a disc using a personal computer, even if it is recorded in a compatible format, there are cases in which it may not play because of the settings of the application software used to create the disc. (Check with the software publisher for more detailed information.)

Playable Discs

 DVD
(8 cm/12 cm disc)

 Video CD (VCD)
(8 cm / 12 cm disc)

 Audio CD
(8 cm/12 cm disc)

In addition, the DVD Recorder+VCR can play SVCD; DVD-R/DVD-RW discs; DVD+R/DVD+RW discs; CD-R/CD-RW discs that contain audio titles, MP3 files, or JPEG files; and Kodak Picture CDs.

Notes

- Depending on the conditions of the recording equipment or the recordable disc (including CD-R/RW, DVD-R/-RW, and DVD+R/+RW), some discs cannot be played on the DVD Recorder+VCR.
- Do not attach any seal or label to either side (the labeled side or the recorded side) of a disc.
- Do not use irregularly shaped CDs (e.g., heart-shaped or octagonal). Doing so may result in malfunctions.

Regional code of the DVD Recorder+VCR and DVDs

This DVD Recorder+VCR is designed and manufactured for playback of Region 1 encoded DVD software. The region code on the labels of some DVD discs indicates which type of DVD Recorder+VCR can play those discs. The DVD Recorder+VCR can play only DVD discs labeled 1 or



ALL. If you try to play any other discs, the message "Incorrect region code. Can't playback" will appear on the TV screen. Some DVD discs may not have a region code label even though their playback is prohibited by area limits.

Notes on DVDs and Video CDs

Some DVD and Video CD playback operations may be intentionally set by the software manufacturer. As this DVD Recorder+VCR plays DVDs and Video CDs according to disc content designed by the software manufacturer, some DVD and Video CDs playback features may not be available or other functions may be added. Refer also to the instructions supplied with your DVDs and Video CDs. Some DVDs made for business purposes may not be played on this unit.

Disc-related Terms

Title (DVD only)

The main film content or accompanying feature content or music album. Each title is assigned a title reference number enabling you to locate it easily.

Chapter (DVD only)

Sections of a picture or a musical piece that are smaller than titles. A title is composed of one or several chapters. Each chapter is assigned a number to enable you to easily locate the chapter you want. Depending on the disc, chapters may not be labeled.

Track (Video CD and Audio CD only)

Sections of a picture or a musical piece on a video CD or an audio CD. Each track is assigned a number, enabling you to easily locate the track you want.

Scene

On a video CD with PBC (Playback Control), movies and pictures are divided into "Scenes". Each scene is displayed on a menu and assigned a number, enabling you to quickly locate the scene you want. A scene may be composed of one or several tracks.

Types of video CDs

There are two types of video CDs:

Video CDs equipped with PBC (Version 2.0)

PBC (Playback control) allows you to interact with the contents of a Video CD using menus, search functions, and other special operations. High resolution pictures can be displayed if they are included on the disc.

Video CDs not equipped with PBC (Version 1.1)

Video CDs without PBC are similar to audio CDs, except they allow playback of video as well as sound.

VR4940 Overview (Continued)

About DVD-R and DVD-RW Discs

How are DVD-R and DVD-RW discs different?

DVD-R is a record-once medium, while DVD-RW is a re-recordable/erasable medium. You can re-record/erase a DVD-RW disc approximately 1,000 times.

Can I play my discs in a regular DVD player?

DVD-R discs and DVD-RW discs recorded in "Video mode" are playable in most standard DVD players, but they must be finalized first. This process fixes the contents of your discs so they are readable on other DVD players as standard DVD-Video discs. DVD-RW discs recorded in "VR mode" (Video Recording mode) are only readable on players with the "RW Compatible" logo.



This logo indicates that a product is capable of playing DVD-RW discs recorded in "VR mode".

What are "Recording Modes"?



Two recording modes are available on your DVD Recorder+VCR: "Video mode" and "VR mode":

About "VR mode"

- Compatible with DVD-RW discs only
- Allows extensive editing of DVD-RW recordings
- Discs are not playable on regular DVD players
- 3 different picture quality/recording time settings are available: XP (1 hr/disc), SP (2 hrs/disc), and LP (4 hrs/disc)

About "Video mode"

- Compatible with both DVD-R and DVD-RW discs
- Provides limited editing features
- Playable on most regular DVD players (after finalizing)
- 3 different picture quality/recording time settings are available: XP (1 hr/disc), SP (2 hrs/disc), and LP (4 hrs/disc)

Many DVD Recorder+VCR functions are dependent on the Recording mode. One or more of the symbols ( , ) appears by each function explained in this manual so you can see at a glance whether it is available for the type of disc you have loaded.

Note

DVD-R/RW discs formatted in "Video mode" are recorded in the DVD-Video format, which was approved by the DVD Forum in 2000. As a result, you may experience problems playing your discs in some older players. Symptoms include video artifacts, audio and/or video dropouts and playback suddenly stopping. Our company cannot take responsibility for problems playing discs recorded on this DVD Recorder+VCR in other players.

Is Editing a DVD like Editing a Videotape?

No. When you edit a videotape you need one video deck to play the original tape and another to record the edits. With DVD, you edit by making a "Playlist" of what to play and when to play it. During playback, the DVD Recorder+VCR plays the disc according to your Playlist.

"Original" Content vs "Playlist" Content

Throughout this manual, you will often see the words "Original" and "Playlist" to distinguish between the actual content on your DVD-R/RW and the edited version.

- **Original:** Refers to what is actually recorded on the disc.
- **Playlist:** Refers to the edited version of the disc — i.e., how the Original content is to be played.

About DVD Recording

Notes

- The DVD Recorder+VCR cannot make recordings on DVD+R, DVD+RW, CD-R, or CD-RW discs.
- Our company takes no responsibility for recording failure due to power outages, defective discs, or damage to the DVD Recorder+VCR.
- Fingerprints and small scratches on a disc can affect playback and/or recording performance. Please take proper care of your discs.

Disc Types and Recording Formats

The DVD Recorder+VCR can play these kinds of DVD discs:

1. Pre-recorded DVD-Video discs
2. DVD-R/DVD-RW discs
3. DVD+R/DVD+RW discs

DVD-R discs are always formatted in "Video mode"—the same format as pre-recorded DVD-Video discs. This means that once a DVD-R disc is finalized, you can play it in most standard DVD players.

DVD-RW discs can be formatted in either "Video mode" or "VR mode" (Video Recording mode). Keep in mind that changing between these modes requires you to re-initialize the disc, which will erase its contents.

VR4940 Overview (Continued)

Notes for Recording

- The recording times shown are not exact because the DVD Recorder+VCR uses variable bit-rate video compression. This means that the exact recording time will depend on the material being recorded.
- When recording a TV broadcast, if the reception is poor or the picture contains interference, the recording times may be shorter.
- If you record still pictures or audio only, the recording time may be longer.
- The displayed times for recording and time remaining may not always add up to exactly the length of the disc.
- The recording time available may decrease if you heavily edit a disc.
- If using a DVD-RW disc, make sure you change the recording format (Video mode or VR mode) before you record anything on the disc. See page 24 (“DISC Initialize”) for how to do this.
- When using a DVD-R disc, you can keep recording until the disc is full, or until you finalize the disc. Before you start a recording session, check the amount of recording time left on the disc.
- When using a DVD-RW disc in Video mode, recording time available will only increase if you erase the last title recorded on the disc.
- The Erase Title option in the Original (Title) menu only hides the title, it does not actually erase the title from the disc and increase the recording time available (except for the last recorded title on a DVD-RW disc in Video mode).

Recording TV Audio Channels

The DVD Recorder+VCR can record one or two channel audio. For TV broadcasts, this usually means mono or stereo, but some programs are broadcast with a main and a SAP (Secondary Audio Program) audio channel.

If you're recording in Video mode (or in VR mode), you can record either the main audio or the SAP audio.

Restrictions on Video Recording

- You cannot record copy-protected video using this DVD Recorder+VCR. Copy-protected video includes DVD-Video discs and some satellite broadcasts. If copy-protected material is encountered during a recording, recording will pause or stop automatically and an error message will be displayed on-screen.
- Video that is 'copy-once only' can only be recorded using a DVD-RW disc in VR mode with CPRM (see below).

What is 'CPRM'?

CPRM is a copy protection system (with scramble system) only allowing the recording of 'copy once' broadcast programs. CPRM stands for Content Protection for Recordable Media.

The DVD Recorder+VCR is CPRM compatible, which means that you can record copy-once broadcast programs, but you cannot then make a copy of those recordings. CPRM recordings can only be made on DVD-RW discs formatted in VR mode, and CPRM recordings can only be played on players that are specifically compatible with CPRM.

Copyright Notice

- Audio and video recordings you make using the DVD Recorder+VCR are for your personal use only. You may not sell, lend or rent them to other people.
- This product incorporates copyright protection technology that is protected by method claims of certain U.S. patents and other intellectual property rights owned by Macrovision Corporation and other rights owners. Use of this copyright protection technology must be authorized by Macrovision Corporation, and is intended for home and other limited viewing uses only unless otherwise authorized by Macrovision corporation. Reverse engineering or disassembly is prohibited.

Disc type	Disc format	Recording mode	Functions
DVD-Video	Video format	n/a	Playback only
DVD-RW	Video Recording format (default)	VR mode	Playback, recording, Original/Playlist editing
	Video format	Video mode	Playback, limited recording, limited editing
DVD-R	Video format	Video mode	Playback, limited recording, limited editing
DVD+R	Video format	n/a	Playback only
DVD+RW	Video format	n/a	Playback only

VR4940 Overview (Continued)

Precautions

Handling the Unit

When shipping the unit

The original shipping carton and packing materials come in handy. For maximum protection, re-pack the unit as it was originally packaged at the factory.

When setting up the unit

The picture and sound of a nearby TV, VCR, or radio may be distorted during playback. In this case, position the unit away from the TV, VCR, or radio, or turn off the unit after removing the disc.

To keep the surface clean

Do not use volatile liquids, such as insecticide spray, near the unit. Do not leave rubber or plastic products in contact with the unit for a long period of time. They will leave marks on the surface.

Cleaning the Unit

To clean the cabinet

Use a soft, dry cloth. If the surfaces are extremely dirty, use a soft cloth lightly moistened with a mild detergent solution. Do not use strong solvents such as alcohol, benzene, or thinner, as these might damage the surface of the unit.

To obtain a clear picture

The DVD Recorder+VCR is a high-tech, precision device. If the optical pick-up lens and disc drive parts are dirty or worn, the picture quality will be poor. Regular inspection and maintenance are recommended after every 1,000 hours of use. (This depends on the operating environment.)
For details, please contact your nearest dealer.

Remote Control Operation Range

Point the remote control at the remote sensor and press the buttons.

- **Distance:** About 23 ft (7 m) from the front of the remote sensor.
- **Angle:** About 30° in each direction of the front of the remote sensor.

Remote Control Battery Installation

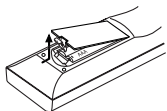

Detach the battery cover on the rear of the remote control, and insert two size AAA batteries with **+** and **-** aligned correctly.

Caution

Do not mix old and new batteries. Never mix different types of batteries (standard, alkaline, etc.).

Notes on Discs

Handling Discs

Do not touch the playback side of the disc. Hold the disc by the edges so that fingerprints will not get on the surface. Do not stick paper or tape on the disc.



Storing Discs

After playing, store the disc in its case.

Do not expose the disc to direct sunlight or sources of heat, or leave it in a parked car exposed to direct sunlight, as there may be a considerable temperature increase inside the car.

Cleaning Discs

Fingerprints and dust on the disc can cause poor picture quality and sound distortion. Before playing, clean the disc with a clean cloth. Wipe the disc from the center outward.

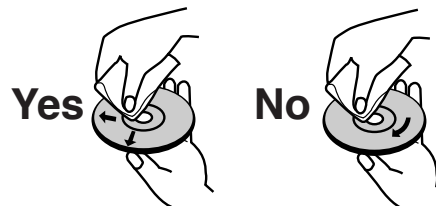

Do not use strong solvents such as alcohol, benzene, thinner, commercially available cleaners, or anti-static spray intended for older vinyl records.

About Symbols

About the Symbol

“” may appear on the TV screen during operation. This icon means the function explained in this owner's manual is not available on that specific disc.

Symbols Used in this Manual

A section whose title has one of the following symbols is applicable only to those discs represented by the symbol.

 DVD-R/RW in “Video mode”

 DVD-RW in “VR mode”

 DVD-Video disc

 Video CDs

 Audio CD

 MP3 Disc

 JPEG Disc

 VHS Tape

Front Panel Overview

POWER button and indicator

Switches the DVD Recorder+VCR ON and OFF.
Lights green when the DVD Recorder+VCR is turned on.

EJECT (VCR)

Ejects the tape in the VCR deck.

Cassette Compartment (VCR deck)

Insert a video cassette here.

EJECT (DVD) (▲)

Opens or closes the disc tray.

Disc Tray (DVD deck)

Insert a disc here.

SELECT DVD/VCR

Toggles control between the DVD deck and the VCR deck.

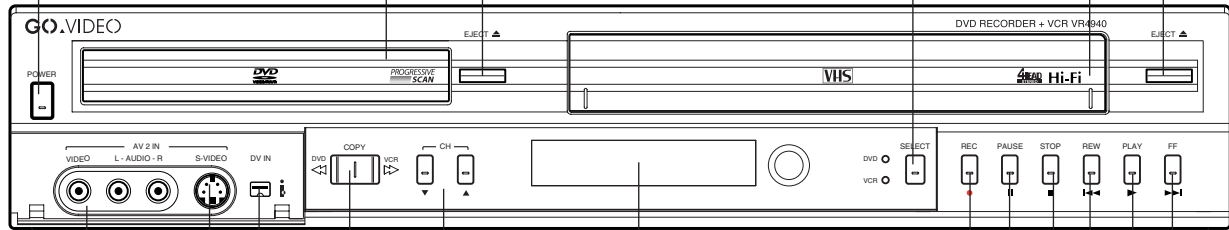

FLAP
DOOR
OPEN

Front Panel Display

Shows the current status of the DVD Recorder+VCR.

CH (▼ / ▲)

Scans up or down through memorized channels.

REC (●)

Starts recording. Press repeatedly to set the recording time.

COPY

Copies from DVD to VCR (or from VCR to DVD).

PAUSE (II)

Pauses playback or recording temporarily. Press repeatedly for frame-by-frame playback.

DV IN

Connects to the DV output of a digital camcorder.

STOP (■)

Stops playback.

S-VIDEO IN

Connects to the S-Video output of an external source (VCR, Camcorder, etc.).

AV 2 IN (VIDEO, L-AUDIO-R)

Connects to the audio/video output of an external source (VCR, Camcorder, etc.).

REW (◀◀)

DVD: Skips to the beginning of the current chapter/track or to the previous chapter/track. Press and hold for fast reverse search.
VCR: Rewinds the tape during Stop mode. Press during Play mode for fast reverse picture search.

PLAY (▶)

Starts playback of a disc or tape.

FF (▶▶)

DVD: Skips to the next chapter/track. Press and hold for fast forward search.
VCR: Advances the tape during Stop mode. Press during Play mode for fast forward picture search.

Front Panel Display Overview

Disc Type indicators

Indicates the type of disc loaded.

 Indicates that a timer recording is in progress or is programmed.

REC Indicates that a recording is in progress.

PRG Indicates that program playback is active.

TTL Indicates current title number.

 Indicates a disc is inserted in the DVD deck.

 Indicates a VHS tape is inserted in the VCR deck.

 Indicates a DVD-RW disc (VR mode only) is inserted in the DVD deck.

CHP/TRK Indicates the current chapter or track number.

TV Indicates the DVD Recorder+VCR is in TV mode (as set by the TV/VCR button).

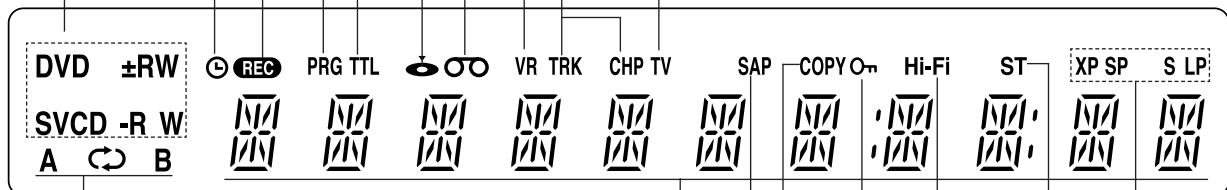

REPEAT Indicates current Repeat mode.

Front Panel Display Message

Indicates clock, total playing time, elapsed time, remaining time, title number, chapter/track number, channel, etc.

SAP Indicates when a Second Audio Program (SAP) broadcast is being received.

COPY Indicates that a DVD to VCR (or VCR to DVD) copy is in progress.

Indicates when the DVD Recorder+VCR is locked.

Hi-Fi Indicates when the DVD Recorder+VCR is playing or recording a tape in Hi-Fi.

ST Indicates that a stereo broadcast is being received.

SP, SLP, LP, XP Indicates the current Recording mode.

Remote Control Overview

POWER
Turns DVD Recorder+VCR on and off.

TV/VCR
Switches between the DVD Recorder+VCR tuner and your TV tuner.

DVD
Selects DVD mode.

VCR
Selects VCR mode.

INPUT
Switches the DVD Recorder+VCR input to Tuner, AV1, AV2, or DV IN.

0-9 buttons
Selects numbered options in menus.
Selects TV channels.

TV Control Buttons
TV POWER: Turns TV on and off.
TV INPUT: Selects TV input source.

CH ▲/▼: Selects TV channels.
VOL +/-: Adjusts TV volume.
MUTE: Turns TV sound on or off.

REC MODE
Selects Recording mode:
- DVD : XP (1 hr), SP (2 hrs), or LP (4 hrs).
- VCR : SP or SLP.

TIMER RECORD
Displays Timer Recording menu.

REC (●)
Starts recording. Press repeatedly to set the recording time.

REW/FF (◀◀ / ▶▶)
DVD: Searches backward/forward.
VCR: Rewinds/advances during Stop mode. Press during Play mode for fast reverse/forward picture search.

PREV/NEXT (◀◀ / ▶▶)
Skips to next chapter/track. Returns to beginning of current chapter/track or skips to previous chapter/track.

AUDIO
Selects an audio language (DVD) or audio channel (CD).

SUBTITLE
Selects a subtitle language.

ANGLE
Selects a DVD camera angle, if available.

ZOOM
Enlarges DVD video image.

CHILD LOCK

The Lock feature disables the front panel buttons to prevent children from tampering with the DVD Recorder+VCR. Simply press LOCK on the remote control to toggle this feature on and off.

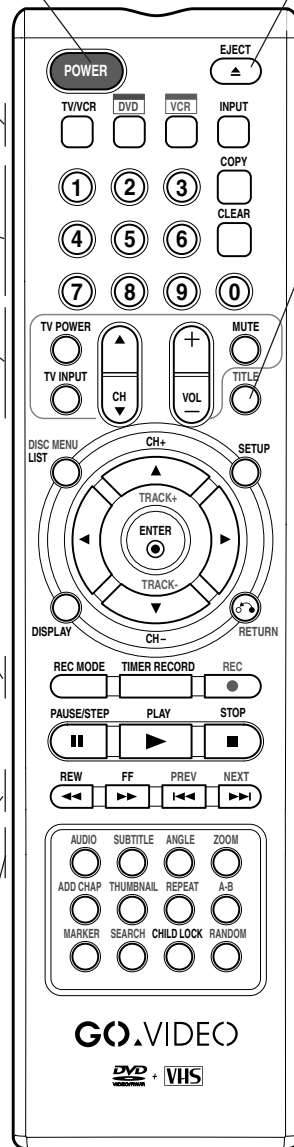

Tip

All buttons on the remote control light for approximately 5 seconds whenever you press a button. This allows you to see the remote functions clearly in a dark or dimly lit room.

EJECT
- Opens and closes disc tray.
- Ejects tape in VCR deck.

COPY
Copies DVD to VCR (or VCR to DVD).

CLEAR
Removes bookmarks from Marker Search menu.

TITLE
Displays disc's Title menu, if available.

DISC MENU/LIST
Accesses menus on DVD discs.
Switches between Original and Playlist editing in VR mode.

SETUP
Displays or exits Setup menu.

DISPLAY
Displays or exits On-Screen Display.

RETURN (↶)
Exits or returns to previous screen in Setup menu.

◀ ▶ ▲ ▼ (left/right/up/down)
Selects menu options.

CH/TRACK(▲/▼): Selects channels in VCR mode. Manually adjusts tracking.

ENTER
Confirms menu selections.

PAUSE/STEP (||)
Pauses playback or recording temporarily. Press again to exit Pause mode. Press repeatedly for frame-by-frame playback.

PLAY (▶)
Starts playback.

STOP (■)
Stops playback or recording.

ADD CHAP
Inserts chapter marker when playing/recording DVD-RW disc in VR mode.

THUMBAIL
Selects thumbnail picture for current title for use in Original (Title).

REPEAT
Repeats chapter, track, title, or all.

A-B
Repeats sequence between two points (A and B).

MARKER
Marks any point during playback.

SEARCH
Displays Marker Search menu.

CHILD LOCK
Locks/unlocks front panel buttons.

RANDOM
Plays tracks in random order.

Rear Panel Overview

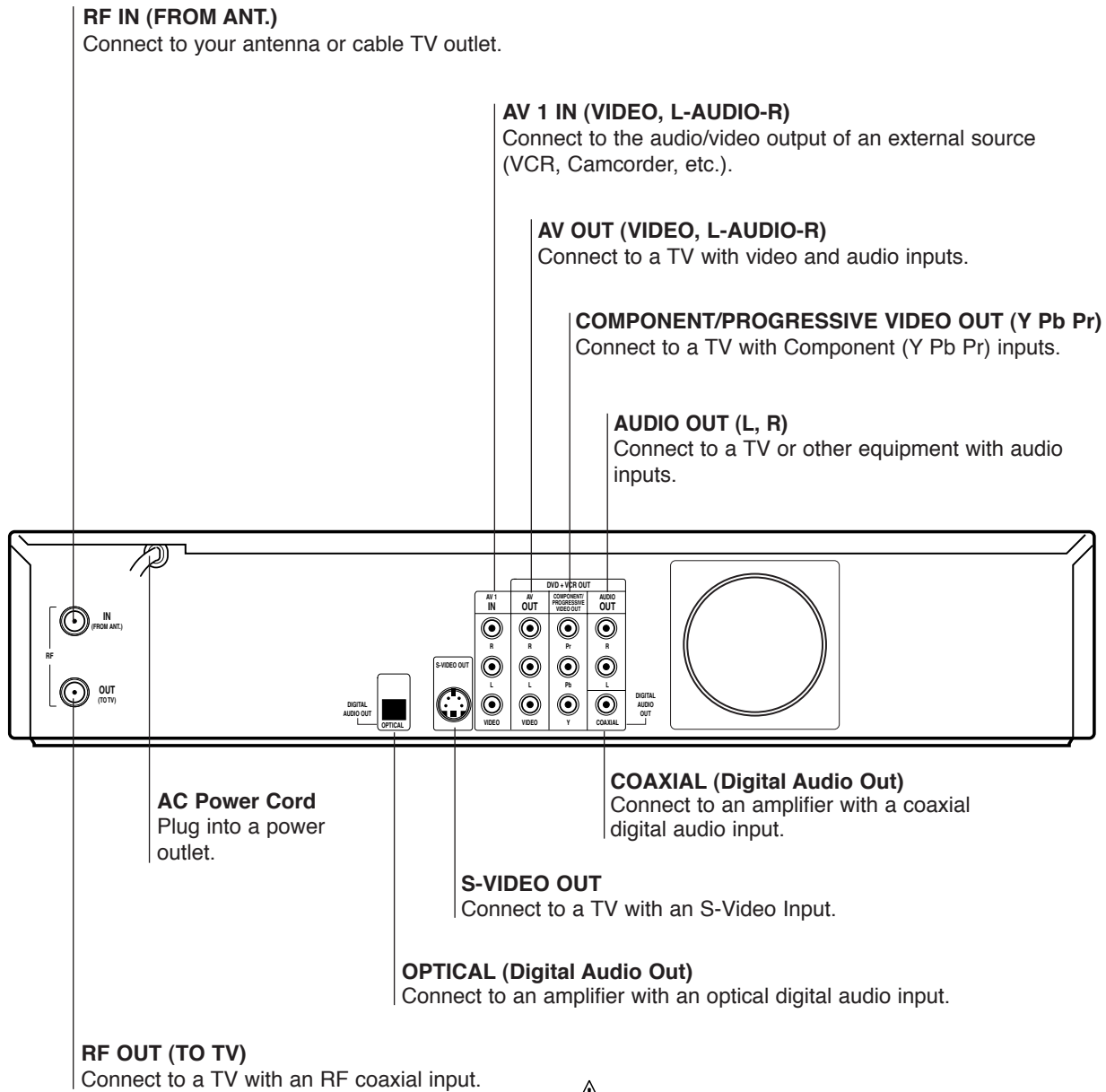

Caution

Do not touch the inner pins of the jacks on the rear panel. Electrostatic discharge may cause permanent damage to the DVD Recorder+VCR.

Connections

Tips

- There are a variety of ways to connect the DVD Recorder+VCR to your TV and other equipment. Use only one of the connections described below. Whichever TV connection you use will work with all input sources.
- Please refer to the manuals for your TV, VCR, stereo system or other devices as necessary to make the best connections.
- For better sound reproduction, connect the DVD Recorder+VCR's AUDIO OUT jacks to the audio in jacks of your amplifier, receiver, stereo or audio/video equipment. See "Connecting an Amplifier/Receiver" on page 16.

Caution

- Make sure the DVD Recorder+VCR is connected directly to the TV, and the TV is set to the correct video input.
- Do not connect the DVD Recorder+VCR's AUDIO OUT jack to the phono in jack (record deck) of your audio system.
- Do not connect the DVD Recorder+VCR via your VCR. The DVD image could be distorted by the copy protection system.

Connecting Antenna/Cable

- 1 Disconnect the antenna/cable from the rear of your TV.
- 2 Identify the type of cable from your antenna. If it is a round cable as illustrated, it is a 75 ohm coaxial antenna cable. This cable will connect directly to the jack marked RF IN (FROM ANT.) on the DVD Recorder+VCR.

Tip

If your antenna lead wire is a flat type antenna cable, connect it to a 300-ohm to 75-ohm antenna adaptor (not supplied) and slip the adaptor onto the RF IN (FROM ANT.) jack. The Adapter does not screw on to the unit, it just slips over the jack.

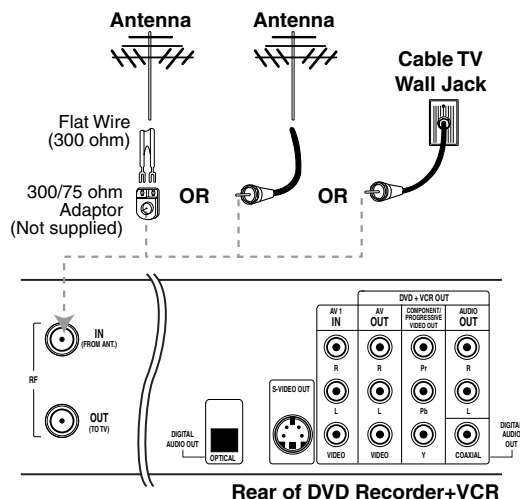

Cable Service Without Cable Box

If your cable wire is connected to your TV without a converter or descrambler box, unscrew the wire from your TV and attach it to the RF IN (FROM ANT.) jack on the DVD Recorder+VCR. Use the supplied coaxial cable to connect between the DVD Recorder+VCR's OUT (TO TV) jack and the 75 ohm antenna input jack on your TV. With this connection, you can receive all midband, superband, and hyperband channels (all cable channels).

Cable Service With Cable Box

If a cable box is required in your cable system, follow the instructions shown below. This hookup permits both TV and DVD Recorder+VCR operation.

To view or record a CATV channel:

- 1 Tune the TV to the correct video input channel.
- 2 Set the DVD Recorder+VCR to the output channel of the cable box using the CH (▲ / ▼) or the 0-9 keys on your DVD Recorder+VCR (e.g., CH3).
- 3 Select the channel you wish to view on the cable box.

Note

If you are using a cable box to tune channels, it is not necessary to run Auto Channel Set as indicated on page 18.

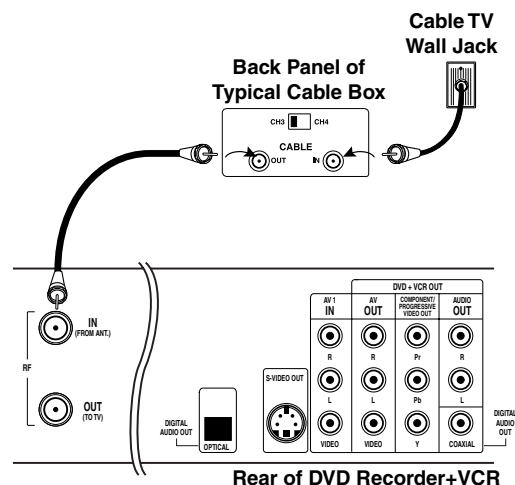

Connections (Continued)

Connecting a TV

Choose one of the following TV connections, depending on the capabilities of your equipment.

Note

All video signals are available from all video outputs. That means that whichever TV connection you use, it will work with all input sources, including VHS out of the Component/Progressive Video Output.

RF Coaxial Connection

Connect the RF OUT (TO TV) jack on the DVD Recorder+VCR to the antenna in jack on your TV using the supplied 75-ohm coaxial cable (R). If you use this connection, tune your TV to the DVD Recorder+VCR's RF output channel (CH 3 or 4).

How to set the DVD Recorder+VCR's RF output channel

Turn off the DVD Recorder+VCR, then press and hold CH (▲/▼) on the front panel for about five seconds to change the RF output channel (CH 03 or CH 04). "RF 03" or "RF 04" appears on the front panel display.

Audio/Video Connection

- 1 Connect the VIDEO OUT jack on the DVD Recorder+VCR to the video in jack on your TV using the supplied video cable (V).
- 2 Connect the Left and Right AUDIO OUT jacks from the DVD Recorder+VCR to the left/right audio in jacks on your TV using the supplied audio cables (A).

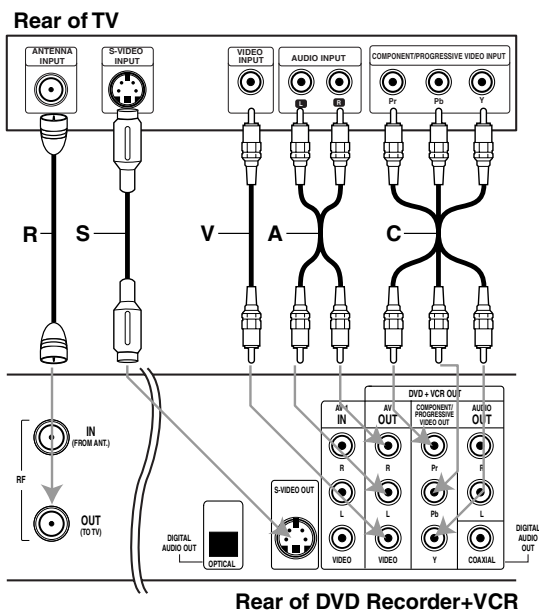

S-Video Connection

- 1 Connect the S-VIDEO OUT jack on the DVD Recorder+VCR to the S-Video in jack on your TV using an S-Video cable (S).
- 2 Connect the Left and Right AUDIO OUT jacks from the DVD Recorder+VCR to the left/right audio in jacks on your TV using the supplied audio cables (A).

Component Video Connection

- 1 Connect the COMPONENT/PROGRESSIVE VIDEO OUT jacks on the DVD Recorder+VCR to the corresponding in jacks on your TV using a Y Pb Pr cable (C).
- 2 Connect the Left and Right AUDIO OUT jacks from the DVD Recorder+VCR to the left/right audio in jacks on your TV using the supplied audio cables (A).

Progressive Scan Connection

- If your television is a high-definition or "digital ready" television, you may take advantage of the DVD Recorder+VCR's Progressive Scan output for the highest video resolution possible.
- If your TV does not accept the Progressive Scan format, the picture will appear scrambled.

- 1 Connect the COMPONENT/PROGRESSIVE VIDEO OUT jacks on the DVD Recorder+VCR to the corresponding in jacks on your TV using an optional Y Pb Pr cable (C).
- 2 Connect the Left and Right AUDIO OUT jacks from the DVD Recorder+VCR to the left/right audio in jacks on your TV using the supplied audio cables (A).

Notes

- Be sure to set the Progressive Scan option to "ON" in the General menu; see page 20.
- Progressive Scan does not work with the RF, Audio/Video or S-Video connections.

Connections (Continued)

Connecting an Amplifier/Receiver

Connecting to an amplifier equipped with two channel analog stereo or Dolby Pro Logic II/ Pro Logic

Connect the Left and Right AUDIO OUT jacks on the DVD Recorder+VCR to the left and right audio in jacks on your amplifier, receiver, or stereo system, using the supplied audio cables (A).

Connecting to an amplifier equipped with two channel digital stereo (PCM) or to an Audio/ Video receiver equipped with a multi-channel decoder (Dolby Digital™, MPEG 2, or DTS)

- 1 Connect one of the DVD Recorder+VCR's DIGITAL AUDIO OUT jacks (OPTICAL **O** or COAXIAL **X**) to the corresponding in jack on your amplifier. Use an optional digital (optical **O** or coaxial **X**) audio cable.
- 2 You will need to activate the DVD Recorder+VCR's digital output; see "AUDIO Settings" on page 21.

Digital Multi-Channel Sound

A digital multi-channel connection provides the best sound quality. For this you need a multi-channel audio/video receiver that supports one or more of the audio formats supported by your DVD Recorder+VCR (MPEG 2, Dolby Digital and DTS). Check the receiver manual and the logos on the front of the receiver.

Caution:

Due to the DTS Licensing agreement, the digital output will be in DTS digital out when DTS audio stream is selected.

Notes

- If the audio format of the digital output does not match the capabilities of your receiver, the receiver will produce a strong, distorted sound or no sound at all.
- 5.1 channel digital surround sound via the digital connection can only be obtained if your receiver is equipped with a digital multi-channel decoder.
- To see the audio format of the current DVD on the on-screen display, press AUDIO.

Note

The DVD Recorder+VCR does not perform internal (2-channel) decoding of DTS sound tracks. To enjoy DTS multi-channel surround, you must connect the DVD Recorder+VCR to a DTS compatible receiver via one of the DVD Recorder+VCR's digital audio outputs.

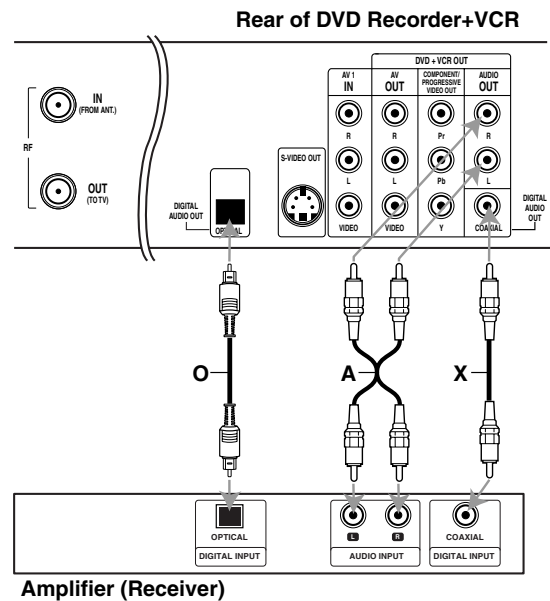

Connections (Continued)

Connecting Optional Equipment

Connect the AV 1 IN or AV 2 IN jacks on the DVD Recorder+VCR to the audio/video out jacks on your external component, using optional audio/video cables.

Note

If you use the S-VIDEO jack on the front panel, there will be no signal output from the front panel VIDEO jack.

Jack Panel of Accessory Component (VCR, Camcorder, etc.)

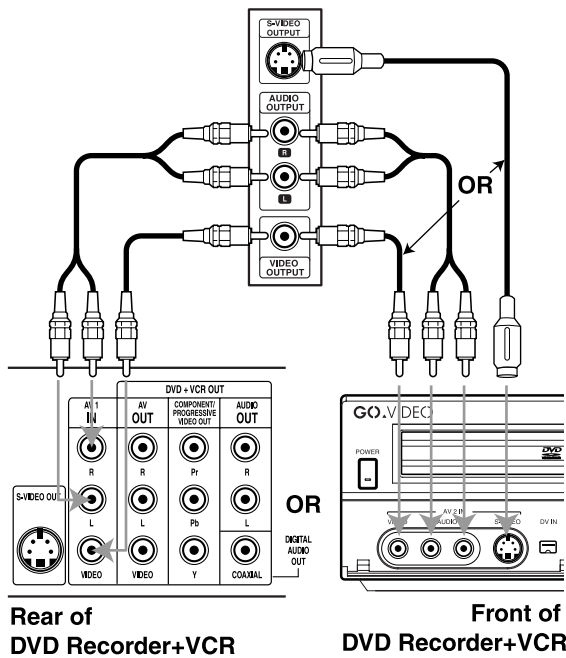

Rear of
DVD Recorder+VCR

Front of
DVD Recorder+VCR

Connecting a Digital Camcorder

Using the front panel DV IN jack, it is possible to connect a DV digital camcorder, video deck or DVD-R/RW recorder and digitally transfer DV tapes or DVD-R/RW discs to DVD-R/RW.

Use a DV cable (not supplied) to connect the DV in/out jack of your DV camcorder/video deck to the front panel DV IN jack of the DVD Recorder+VCR.

Note

This jack is for connection to DV equipment only. It is not compatible with digital satellite tuners or D-VHS video decks.

DV Digital Camcorder

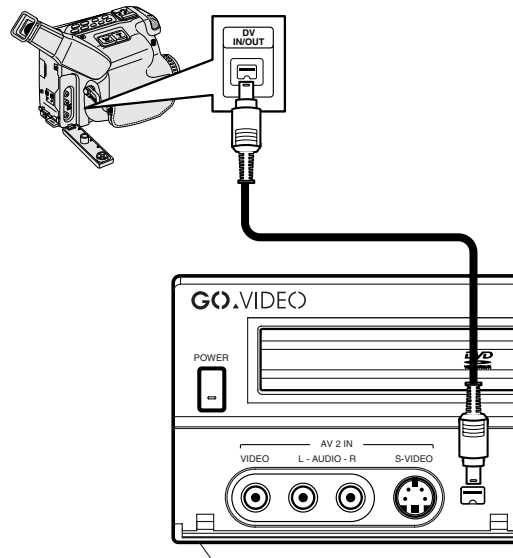

Front of DVD Recorder+VCR

Initial Setup

Setup Menu Overview

The DVD Recorder+VCR Setup menu includes system settings in six categories GENERAL, LANGUAGE, AUDIO, LOCK, RECORD and DISC. Press SETUP on the remote control to view the first and second levels of the Setup menu, and press ► to display the third level. You will see the “►” symbol on the right side of the menu label whenever additional levels are available.

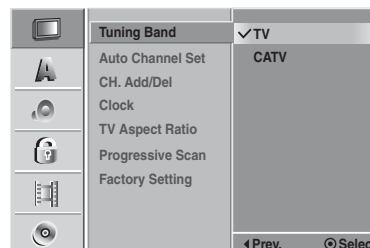

Setup Menu Navigation

- 1 Press SETUP.**
The Setup menu appears.
- 2 Use ▲ / ▼ to select the desired option.**
- 3 While the desired item is selected, press ► to move to the second level.**
- 4 Use ▲ / ▼ to select the second desired option.**
- 5 Press ► to move to the third level.**
- 6 Use ▲ / ▼ to select the desired setting then press ENTER to confirm your selection.**
Some items require additional steps. Press ◀ or RETURN (↵) at any time to return to the previous menu.
- 7 Press SETUP to exit the Setup menu.**

GENERAL Settings

Tuning Band

- 1 Press SETUP.**
The Setup menu appears.
- 2 Use ▲ / ▼ to select the GENERAL option.**
- 3 While the GENERAL option is selected, press ► to move to the second level.**
- 4 Use ▲ / ▼ to select the Tuning Band option.**
- 5 Press ► to move to the third level.**
- 6 Use ▲ / ▼ to select the tuning band option (TV or CATV) then press ENTER.**
TV: If you are using a standard antenna to receive channels.
CATV: If you are using basic cable to receive channels.

Auto Channel Set

The DVD Recorder+VCR is equipped with a frequency synthesized tuner capable of receiving up to 181 channels. These include VHF channels 2-13, UHF channels 14-69 and CATV channels 1-125.

Preparation:

- Connect the DVD Recorder+VCR to the desired type of antenna or cable TV system, as shown in “Connecting Antenna/Cable” on page 14

- 1 Press SETUP.**
The Setup menu appears.
- 2 Use ▲ / ▼ to select the GENERAL option.**
- 3 While the GENERAL option is selected, press ► to move to the second level.**
- 4 Use ▲ / ▼ to select the Auto Channel Set option.**
- 5 Press ► to move to the third level.**
The Start icon is highlighted.
- 6 Press ENTER to begin the channel search.**
The tuner will automatically search for all available channels in your area and place them in the tuner’s memory.

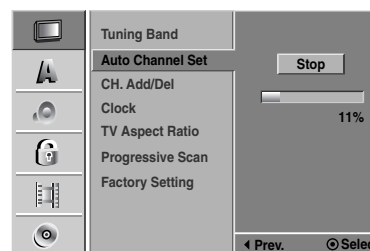

Note

After the Auto Channel Set is complete, follow the instructions at left to make sure the Tuning Band is set correctly (TV or CATV).

Initial Setup (Continued)

Channel Add/Delete

This feature allows you to manually add or delete channels from your channel list.

- 1 Follow steps 1-3 as shown under Auto Channel Set.
- 2 Use **▲ / ▼** to select the CH. Add/Del option.
- 3 Press **▶** to move to the third level.
The Edit icon is highlighted.
- 4 Press **ENTER**.
The Channel Edit menu appears.



- 5 Use **▲ / ▼** or **0-9** to select a channel to add or delete then press **ENTER**.
The Add or Delete icon is highlighted.
- 6 Press **ENTER** to confirm your setting.
- 7 Repeat steps 5-6 to add or delete additional channels.

Clock (Auto)

The DVD Recorder+VCR gives you two ways to set the time and date: Auto or Manual. Auto is the default setting and enables the DVD Recorder+VCR to set the clock whenever the DVD Recorder+VCR is off or in Standby mode.



- 1 Press **SETUP**.
The Setup menu appears.
- 2 Use **▲ / ▼** to select the General option.
- 3 While the General option is selected, press **▶** to move to the second level.
- 4 Use **▲ / ▼** to select the Clock option.
- 5 Press **▶** to move to the third level.

- 6 Use **▲ / ▼** to select the Auto option then press **ENTER**.

The Auto option is set at the factory. In the Auto option, the DVD Recorder+VCR looks for a channel carrying XDS (Extended Data Services) information. XDS updates the clock using the Coordinated Universal Time.

- 7 Use **▲ / ▼** to choose your Time Zone.
You can set your local Time Zone manually. When Time Zone is set to Auto, the DVD Recorder+VCR will use XDS information to determine the proper setting.

- 8 Use **▶** to choose the Daylight Saving option.
Use **▲ / ▼** to choose Auto, On, or Off.
You can turn Daylight Savings On or Off manually. When set to Auto, the DVD Recorder+VCR will use XDS information to determine the proper setting.

- 9 Press **ENTER** to confirm your setting, then press **SETUP** to exit the Setup menu.

Note

If your local TV station does not send date and time information, or sends incorrect information, you can set the clock manually.

Clock (Manual)

- 1 Follow steps 1-5 as shown under Clock (Auto).
- 2 Use **▲ / ▼** to select the Manual option then press **ENTER**.



- 3 Enter the necessary information for date and time.
◀ / ▶ (left/right): Moves the cursor to the previous or next column.
▲ / ▼ (up/down): Changes the setting at the current cursor position.
- 4 Press **ENTER** to confirm your setting, then press **SETUP** to exit the Setup menu.

Initial Setup (Continued)

TV Aspect Ratio

4:3 Letterbox: Select when a standard 4:3 TV is connected. Displays theatrical images with masking bars above and below the picture.

4:3 Fullscreen: Select when a standard 4:3 TV is connected. Displays pictures cropped to fill your TV screen. Both sides of the picture are cut off.

16:9 Widescreen: Select when a 16:9 widescreen TV is connected.

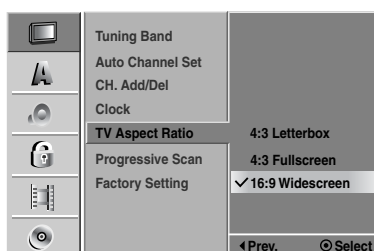

Progressive Scan

Progressive Scan Video provides the highest picture quality with reduced flickering.

- If you are using the COMPONENT/PROGRESSIVE VIDEO OUT jacks, but are connecting the DVD Recorder+VCR to a standard (analog) television, set Progressive Scan to OFF.
- If you are using the COMPONENT/PROGRESSIVE VIDEO OUT jacks for connection to a TV or monitor that is compatible with a Progressive Scan signal, set Progressive Scan to ON.

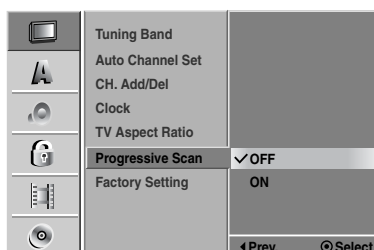

Caution

Once the setting for Progressive Scan output is entered, an image will only be visible on a Progressive Scan compatible TV or monitor. If you set Progressive Scan to ON in error, you must reset the DVD Recorder+VCR. First, remove the disc in the DVD Recorder+VCR. Next, press STOP (■) and hold it for five seconds before releasing it. The video output will be restored to the standard setting, and a picture will once again be visible on a conventional analog TV or monitor.

Factory Setting

If you wish, you can reset the DVD Recorder+VCR to its original factory settings. Select "SET" then press ENTER.

The Initialize menu will appear. Use the ◀ ▶ buttons to select "Yes" and press ENTER.

Note

Some options cannot be reset, including Movie Rating, Password, and Country Code.

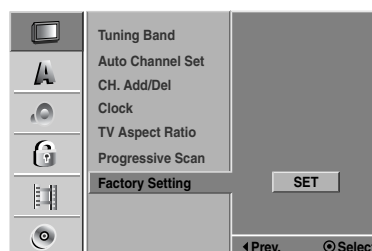

LANGUAGE Settings

Display Menu Language

Select a language for the DVD Recorder+VCR Setup menu and on-screen displays.



DISC Menu/Audio/Subtitle Language

Select your preferred language for Disc Menus, Audio soundtracks, and Subtitles.

Original: The disc's default language is selected.

Other: To select another language, select Other then press ENTER. Use the 0-9 and ENTER buttons to input the corresponding 4-digit number according to the "Language Code List" on page 53. If you make a mistake before pressing ENTER, press ◀ to move the cursor back and correct it.



Initial Setup (Continued)

AUDIO Settings

Each DVD disc has a variety of audio output options. Set the DVD Recorder+VCR's Audio Output according to the type of audio system you use.

Dolby Digital

PCM: Select when connected to a 2-channel digital stereo amplifier. The DVD Recorder+VCR's digital audio signal will be output in the PCM 2ch format when you play a DVD recorded with a Dolby Digital soundtrack.

Bitstream: Select when connected to a Dolby Digital decoder (or an amplifier or other equipment with a Dolby Digital decoder).

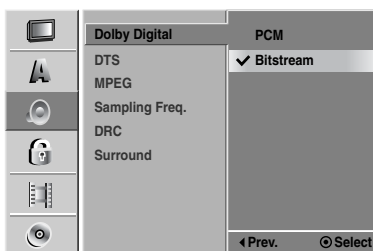

DTS

OFF: The DTS signal will not be output from the DIGITAL AUDIO OUT jacks.

Bitstream: Select when connected to a DTS decoder (or an amplifier or other equipment with a DTS decoder).

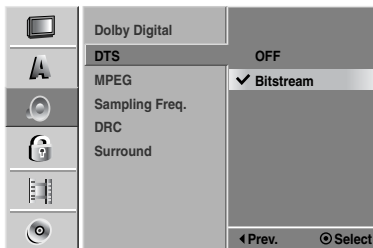

MPEG

PCM: Select when connected to a 2-channel digital stereo amplifier. The DVD Recorder+VCR's digital audio signal will be output in the PCM 2ch format when you play a DVD recorded with an MPEG1 or MPEG2 soundtrack.

Bitstream: Select when connected to an MPEG decoder (or an amplifier or other equipment with an MPEG decoder).

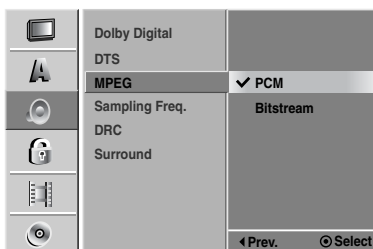

Sampling Frequency

- If your receiver or amplifier is NOT capable of handling 96 kHz signals, select 48 kHz. The DVD Recorder+VCR will automatically convert any 96 kHz signals to 48 kHz so your system can decode them.
- If your receiver or amplifier is capable of handling 96 kHz signals, select 96 kHz. The DVD Recorder+VCR will pass each type of signal through without any further processing.

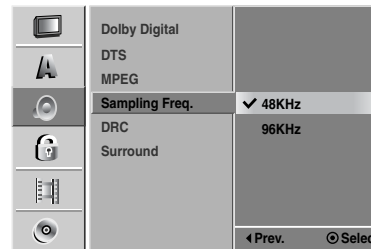

DRC (Dynamic Range Control)

While watching DVD movies, you may wish to compress the dynamic range of the audio output (the difference between the loudest and quietest passages). This allows you to listen to a movie at a lower volume without losing clarity of sound. Set DRC to ON for this effect.

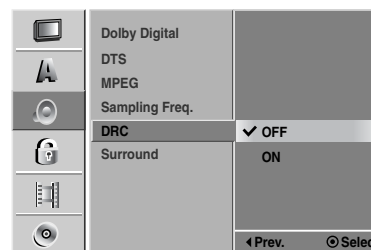

Surround

Select the appropriate Surround Sound option for your audio equipment:

Stereo: Select when connected to an analog amplifier, stereo receiver or stereo television.

3D: Select for a simulated 3D effect from two speakers.

Dolby Digital: Select when connected to a Dolby Digital decoder (or an amplifier or other equipment with a Dolby Digital decoder).

DTS: Select when connected to a DTS decoder (or an amplifier or other equipment with a DTS decoder).

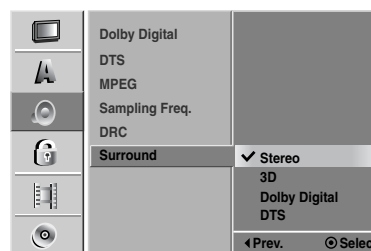

Initial Setup (Continued)

LOCK Settings

Movie Rating

The Lock feature allows you to prevent DVDs from being played based on their ratings or to have certain discs played with alternative scenes.

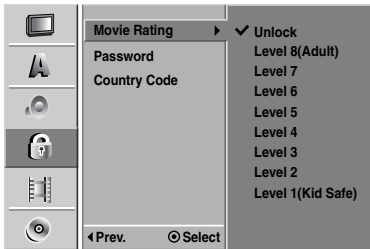

- 1** Press **SETUP**.
The Setup menu appears.
- 2** Use **▲ / ▼** to select the **Lock** option.
- 3** While the **Lock** option is selected, press **▶** to move to the second level.
- 4** Use **▲ / ▼** to select the **Movie Rating** option.
- 5** Press **▶** to move to the third level.
- 6** When you have not entered a password yet.
Enter a 4-digit password using the 0-9 buttons.
Enter the 4-digit password again to confirm.
When you have already entered a password;
Enter your 4-digit password using the 0-9 buttons.



Tip
If you make a mistake before pressing **ENTER**, press **◀** to back up and then re-enter your password.

- 7** Select a rating from 1 to 8 using the **▲ / ▼** buttons. One (1) has the most playback restrictions. Eight (8) has the least playback restrictions.
Unlock: If you select **Unlock**, the **Lock** feature is not active. The disc will play in full.
Level 1 to 8: Some discs contain scenes not suitable for children. If you set a rating for the **DVD Recorder+VCR**, all scenes with the same rating or lower will be played. Higher rated scenes will not be played unless an alternative scene is available on the disc. The alternative must have the same rating or a lower one. If no suitable alternative is found, playback will stop. You must enter the 4-digit password or change the rating level in order to play the disc.
- 8** Press **ENTER** to confirm your rating selection, then press **SETUP** to exit the menu.

Password

Changing the 4-digit code

- 1** Follow steps 1-3 as shown under **Movie Rating**.
- 2** Use **▲ / ▼** to select the **Password** option.
- 3** Press **▶** to move to the third level.
- 4** Follow step 6 as shown under **Movie Rating**.
- 5** While “**Change**” is selected, press **ENTER**.
If you select “**Delete**” then press **ENTER**, the password will be deleted.
- 6** Enter a 4-digit password using the 0-9 buttons.
- 7** Enter the 4-digit password again.



Tip
If you make a mistake before pressing **ENTER**, press **◀** to back up and then re-enter your password.

If you forget your 4-digit code

If you forget your password, follow the procedure below:

- 1** Press **SETUP** to display the Setup menu.
- 2** Use the 0-9 buttons to enter the 5-digit number “21019”. The following message appears on the TV screen: “Memorized password will be erased. Are you sure?”
- 3** Select “**Yes**” then press **ENTER**. The 4-digit password is cleared. Enter a new code as shown above.

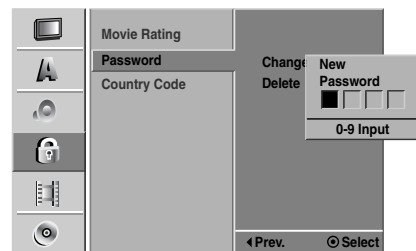

Initial Setup (Continued)

Country Code

Enter the 2-letter code for the country/area whose standards were used to rate your DVDs, referring to the "Country Code List" on page 54.

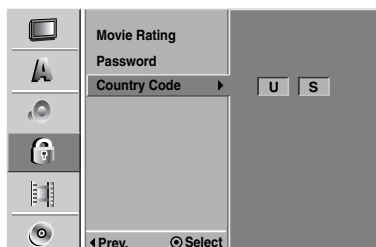

- 1** Press **SETUP**.
The Setup menu appears.
 - 2** Use **▲ / ▼** to select the **Lock** option.
 - 3** While the **Lock** option is selected, press **▶** to move to the second level.
 - 4** Use **▲ / ▼** to select the **Country Code** option.
 - 5** Press **▶** to move to the third level.
 - 6** When you have not entered a password yet.
Enter a 4-digit password using the 0-9 buttons.
Enter the 4-digit password again to confirm.
When you have already entered a password;
Enter your 4-digit password using the 0-9 buttons.
- T**ip
If you a mistake before pressing **ENTER**, press **◀** to back up and then re-enter your password.
- 7** Select the first character using the **▲ / ▼** buttons.
 - 8** Shift the cursor using the **▶** button and select the second character using the **▲ / ▼** buttons.
 - 9** Press **ENTER** to confirm your **Country Code** selection, then press **SETUP** to exit the menu.

RECORD Settings

DISC Record Mode

You can set the default DVD recording quality to: SP (Standard, 2 hrs/disc), LP (Low, 4 hrs/disc), or XP (High, 1 hr/disc).

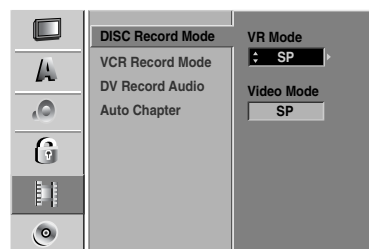

- 1** Press **SETUP**.
The Setup menu appears.
- 2** Use **▲ / ▼** to select the **Record** option.
- 3** While the **Record** option is selected, press **▶** to move to the second level.
- 4** Use **▲ / ▼** to select the **DISC Record Mode** option.
- 5** Press **▶** to move to the third level.
- 6** Use **◀ / ▶** to select **Video Mode** or **VR Mode**.
- 7** Use **▲ / ▼** to select the desired **DISC Record Mode** (SP, LP, or XP).
- 8** Press **ENTER** to confirm your selection, then press **SETUP** to exit the menu.

VCR Record Mode

You can set the default VCR recording quality to SP (Standard Play) or SLP (Super Long Play). SP is higher quality, but SLP provides 3 times the recording time; e.g., a 2 hour tape will record for 6 hours in SLP mode.

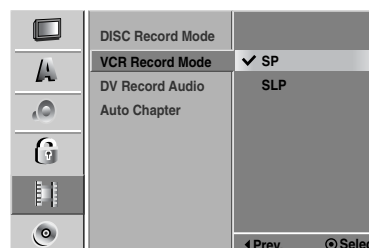

Initial Setup (Continued)

DV Record Audio

You only need to set DV Record Audio if you have a digital camcorder with 32kHz/12-bit sound connected to the front panel DV IN jack. Some digital camcorders have two stereo tracks for audio. One is recorded at the time of shooting; the other is for overdubbing after shooting.

- With the Audio 1 setting, the sound that was recorded while shooting is used.
- With the Audio 2 setting, the overdubbed sound is used.

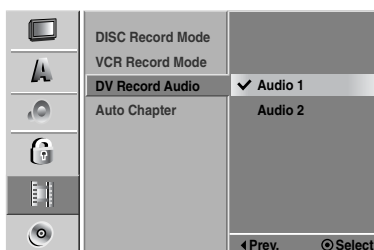

Auto Chapter

During recording (Video mode only), chapter markers are added automatically at fixed intervals. You can set this interval to 3 minutes, 5 minutes or 10 minutes. To turn off automatic chapter marking, select "Not Use".

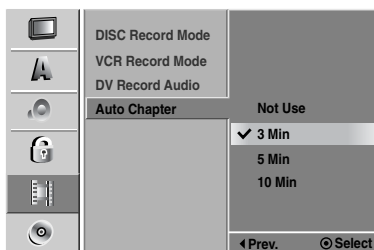

DISC Settings

DISC Initialize

- If you load a blank DVD-R disc, it will always be initialized in Video mode, which allows the disc to be played in most standard DVD players.
- If you load a blank DVD-RW disc, you will be prompted to initialize the disc in Video mode (for maximum compatibility) or VR mode (to enable advanced editing features).
- If you load a DVD-RW that has already been used, you can change between Video mode and VR mode by erasing the disc using the DISC Initialize feature.

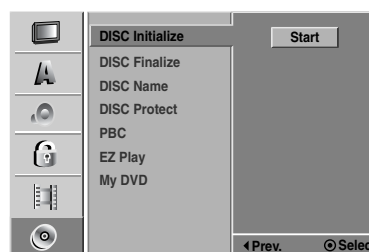

- 1 Press SETUP.**
The Setup menu appears.
- 2 Use ▲ / ▼ to select the Disc option.**
- 3 While the Disc option is selected, press ▶ to move to the second level.**
- 4 Use ▲ / ▼ to select the DISC Initialize option.**
- 5 Press ▶ to move to the third level.**
The Start icon is highlighted.
- 6 Press ENTER.**
The DISC Initialize menu appears.

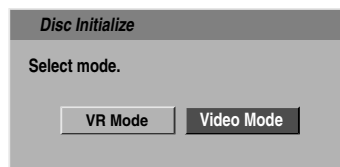

- 7 Use ◀ / ▶ to select the desired DISC Initialize Mode (VR Mode or Video Mode) then press ENTER.**
It may take a few minutes to initialize the disc.

⚠ Caution

If you change the disc format, everything recorded on the disc will be erased.

- 8 Press SETUP to exit the menu.**

Initial Setup (Continued)

DISC Finalize

Finalizing a DVD-R/RW 'locks' its recordings in place so the disc can be played on most standard DVD players or computers equipped with DVD-ROM drives.

Finalizing a disc formatted in Video mode will automatically create a menu screen for navigating the disc. This menu screen is accessible by pressing DISC MENU or TITLE.

Caution

- Once you have finalized a DVD-R disc, you cannot edit or record anything else on that disc. However, you can record and edit a DVD-RW disc by choosing Unfinalize.

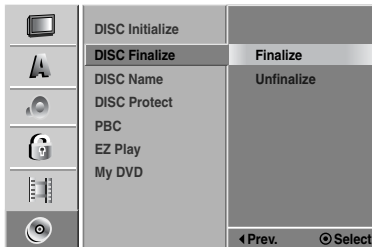

1 Follow steps 1-3 as shown under DISC Initialize.

2 Use ▲ / ▼ to select the DISC Finalize option.

3 Press ► to move to the third level. Finalize is highlighted.

4 Press ENTER. The Finalize menu appears.

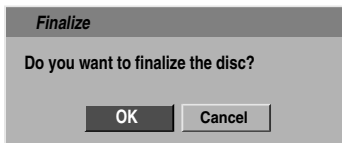

5 Select OK then press ENTER. The DVD Recorder+VCR starts finalizing the disc.

Note

Finalization can take up to 3-4 minutes depending on the type of disc, how much is recorded on the disc, and the number of titles on the disc.

Tip

If you load a DVD-RW that has already been finalized on a different DVD Recorder, you can 'Unfinalize' it by choosing Unfinalize from the Finalize menu. After doing this, you can edit and re-record onto the disc. You cannot unfinalize a DVD-R disc.

DISC Protect

When a DVD-RW disc is formatted in VR mode, set DISC Protect to ON to prevent accidental recording, editing or erasing of the loaded disc. If you need to unlock the disc to make edits, select OFF.

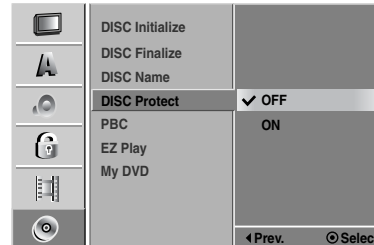

EZ Play

When you load a DVD with EZ Play turned on, the DVD Recorder+VCR will bypass the Disc menu and trailers and start playing the movie automatically. Set Ez Play to ON or OFF.

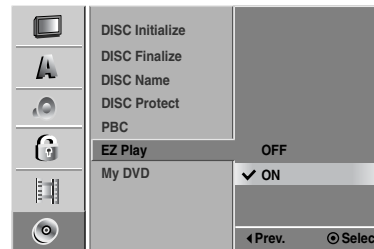

PBC

PBC stands for Playback Control and refers to special menus and navigation features that are available on some Video CDs.

- ON: Video CDs are played according to the PBC, if available.
- OFF: Video CDs are played the same way as Audio CDs.



Initial Setup (Continued)

My DVD

When you load a DVD with the My DVD feature turned on, the DVD Recorder+VCR will automatically search the disc for your Audio, Subtitle and Surround preferences and choose them if available on the disc. Set My DVD to ON or OFF.

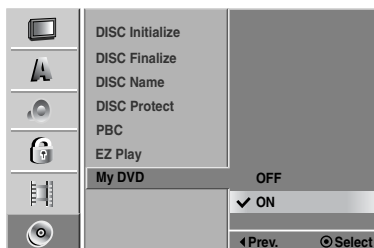

DISC Name

Use the DISC Name feature to enter the name that appears when you load the disc and when you display disc information on-screen.

- The disc name can be up to 32 characters long.
- For discs formatted on a different DVD Recorder, you will see only a limited character set.

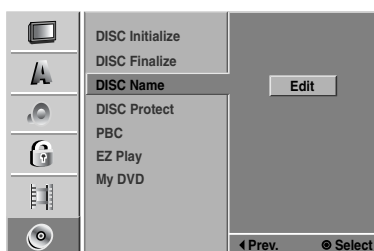

- 1** Follow steps 1-3 as shown under DISC Initialize.
- 2** Use ▲ / ▼ to select the DISC Name option.
- 3** Press ► to move to the third level.
The Edit icon is highlighted.
- 4** Press ENTER.
The Keyboard menu appears.



5 Enter a name for the disc. Use ▲ ▼ ◀ ▶ to select a character, then press ENTER to confirm your selection.

- **English/Latin Capital:** Selects a keyboard with uppercase characters.
- **English/Latin Lowercase:** Selects a keyboard with lowercase characters .
- **Symbols:** Selects a keyboard with all symbols.
- **OK:** Confirms the name you have entered.
- **Cancel:** Deletes all characters and exits the Keyboard menu.
- **Space:** Inserts a space at the cursor position.
- **Delete:** Deletes the character to the left of the cursor.
- ◀ / ▶: Moves the cursor left or right.

T You can also use the remote control to enter DISC Names:

PREV/NEXT (◀◀ / ▶▶): Moves the cursor left or right.

PLAY (▶): Inserts a space at the cursor position.

PAUSE/STEP (||): Deletes the character to the right of the cursor position.

STOP (■), CLEAR: Deletes the character to the left of the cursor position.

0-9: Enters the character corresponding to the selected column.

DISC MENU/LIST, DISPLAY: Switches the keyboard type (English/Latin Capital, English/Latin Lowercase, Symbols).

6 Choose OK then press ENTER to save the name and return to the DISC menu.

7 Press SETUP to exit the menu.

Initial Setup (Continued)

On-Screen Display Overview

The On-Screen Display provides feedback on the status of the DVD Recorder+VCR and/or the currently loaded disc or tape. To access the On-Screen Display (or OSD), press the DISPLAY button.

Displaying Disc Information

To display information about the currently loaded disc or tape:

On-screen display operation

1 Press DISPLAY repeatedly to display/change the information displayed on-screen.

2 To remove the on-screen display, press DISPLAY or RETURN (↵) repeatedly until it disappears.

See the descriptions on pages 28 and 29 for detailed explanations of on-screen displays for each media type.

Notes

- Some discs may not provide all the features shown in the on-screen display examples.
- The on-screen display disappears automatically if no button is pressed for seven seconds.

Temporary Feedback Icons

- ■ ■ Resume play from this point
- ⊘ Action prohibited or not available

Displaying TV Information

While watching TV, press DISPLAY to display/remove the on-screen display.

For example, when a DVD-RW in VR mode is inserted, you would see a screen similar to the following:

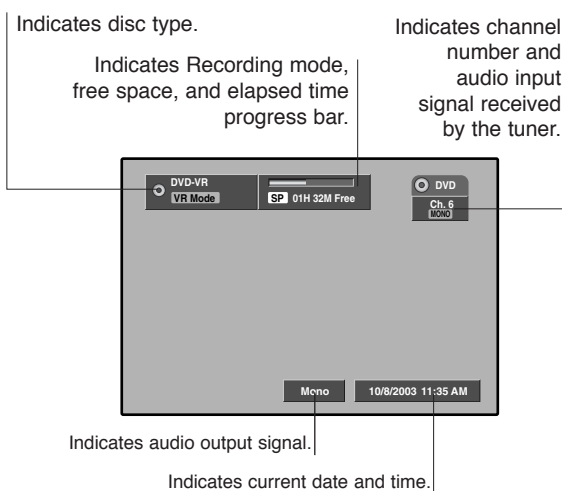

Changing TV Channels

If no disc is playing, you can change TV channels using the 0-9 or CH (+/-) buttons on the remote control or CH (▲ / ▼) buttons on the front panel.

Note

Antenna channels are numbered 2 through 69. Cable channels are numbered 1 through 125.

Changing TV Audio Channel

Some TV programs are broadcast with both a main and a Secondary Audio Program (SAP). You can change the TV audio using the AUDIO button.

Press AUDIO repeatedly to change the TV audio, according to Broadcast audio signal as shown below.

- **STEREO+SAP Audio Signal**
Stereo → SAP → Mono → Stereo
- **STEREO Audio Signal**
Stereo → L → R → Mono → Stereo
- **SAP Audio Signal**
Mono → SAP → Mono
- **MONO Audio Signal**
Mono

The current audio channel is displayed on-screen.

- If SAP is selected, but there is no SAP channel being broadcast, you will still hear the main audio channel.
- If the sound is poor quality when set to Stereo, you can often improve it by changing to Mono.
- When an external input is selected, the audio channel can be switched only to Stereo.

Initial Setup (Continued)

OSD Menu Options by Media Type

DVD

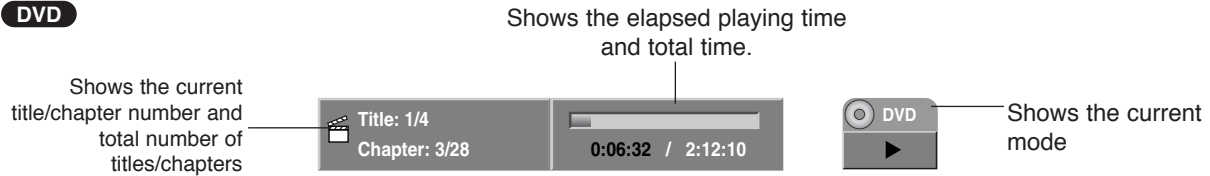

Menu Options	Function (Use ▲ / ▼ to select desired option)	Selection Method
Title number	Shows the current title number and total number of titles, and skips to the desired title number.	◀ / ▶, or 0-9, ENTER
Chapter number	Shows the current chapter number and total number of chapters, and skips to the desired chapter number.	◀ / ▶, or 0-9, ENTER
Time search	Shows the elapsed playing time, and skips to the desired time.	0-9, ENTER
Audio language and Digital Audio Output mode	Shows the current audio soundtrack language, encoding method, and channel number, and changes the setting.	◀ / ▶
Subtitle language	Shows the current subtitle language, and changes the setting.	◀ / ▶
Angle	Shows the current angle number and total number of angles, and changes the angle number.	◀ / ▶
Sound	Shows the current sound mode, and changes the setting.	◀ / ▶

VR

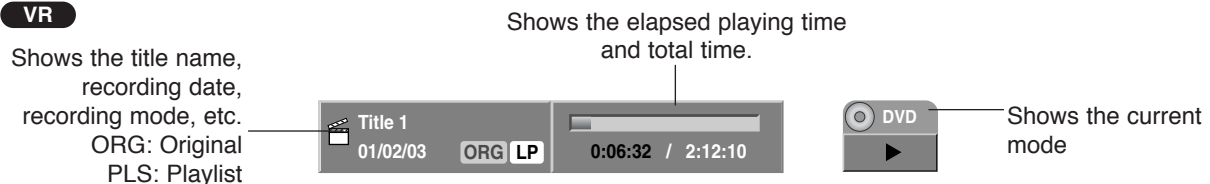

Menu Options	Function (Use ▲ / ▼ to select desired option)	Selection Method
	Shows the current title number and total number of titles, and skips to the desired title number.	◀ / ▶, or 0-9, ENTER
	Shows the current chapter number and total number of chapters, and skips to the desired chapter number.	◀ / ▶, or 0-9, ENTER
	Shows the elapsed playing time, and skips to the desired time.	0-9, ENTER
	Shows the current sound mode, and changes the setting.	◀ / ▶

Initial Setup (Continued)



OSD Menu Options by Media Type (Continued)

Video

Shows the title name, recording date, recording mode, etc.
ORG: Original
PLS: Playlist

Shows the elapsed playing time and total time.

Shows the current mode.

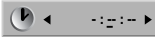
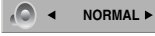



Menu Options	Function (Use ▲ / ▼ to select desired option)	Selection Method
Title number 	Shows the current title number and total number of titles, and skips to the desired title number.	◀ / ▶, or 0-9, ENTER
Chapter number 	Shows the current chapter number and total number of chapters, and skips to the desired chapter number.	◀ / ▶, or 0-9, ENTER
Time search 	Shows the elapsed playing time, and skips to the desired time.	0-9, ENTER
Sound 	Shows the current sound mode, and changes the setting.	◀ / ▶

VCD

Shows the current track number and total number of tracks, or shows PBC On mode.

Shows the elapsed playing time and total time.

Shows the current mode.

Menu Options	Function (Use ▲ / ▼ to select desired option)	Selection Method
Track Number 	Shows the current track number and total number of tracks or PBC On mode, and skips to the desired track number.	◀ / ▶, or 0-9, ENTER
Time 	Shows the elapsed playing time (Display only).	-
Audio Channel 	Shows the current audio channel, and changes the audio channel.	◀ / ▶
Sound 	Shows the current sound mode, and changes the setting.	◀ / ▶

VHS

Shows playback speed, recording information and elapsed playing time progress bar.

Shows the current mode.

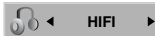
Menu Options	Function (Use ▲ / ▼ to select desired option)	Selection Method
Time 	Shows the elapsed playing time (Display only).	-
Audio channel 	Shows the audio channel, and changes the audio channel.	◀ / ▶

DVD and Video CD Playback

Playing a DVD or Video CD

Playback Setup

- Press the DVD button to set the remote control to operate the DVD deck.
- Turn the TV on and select the video input source connected to the DVD Recorder+VCR.
- Audio system: Turn the audio system on and select the input source connected to the DVD Recorder+VCR.

1 Press EJECT to open the disc tray.

2 Load your disc in the tray with the playback side down.

3 Press EJECT to close the tray. READING appears on the front panel display, and playback starts automatically. If playback does not start, press PLAY (▶). In some cases, the Disc menu might appear instead.

Tip

If a Disc menu is displayed

A Disc menu may be displayed when you load a DVD or Video CD.

DVD

Use the ◀▶ ▲▼ buttons to select the title/chapter you want to view, then press ENTER to start playback. Press TITLE or DISC MENU to return to the Disc menu.

VCD

- Use the number buttons to select the track you want to view.
Press RETURN to return to the menu screen.
- Menu settings and the exact operating procedures for using the menu may differ depending on the disc. Follow the instructions on each menu screen. You may also set PBC to OFF under the DISC Settings menu. See page 25.

Notes

- If the Parental Lock feature is set and the disc is not within the current Movie Rating setting, the 4-digit code must be entered and/or the disc must be authorized; see “Movie Rating” on page 22.
- The DVD Recorder+VCR will not play discs with Region codes different from the DVD Recorder+VCR. The Region code for this DVD Recorder+VCR is 1 (one).

Note

Unless stated otherwise, all operations described use the remote control. Some features may also be available in the Setup menu.

Selecting Titles



When a disc has more than one title, you can select another title as follows:

- Press DISPLAY twice and use ▲ / ▼ to select the Title icon. Then, press 0-9 or ◀ / ▶ to select the desired title number and press ENTER to confirm.

Selecting Chapters/Tracks



When a title on a disc has more than one chapter/track, you can select another chapter/track as follows:

- Press PREV (◀◀) or NEXT (▶▶) briefly during playback to select the next chapter/track or to return to the beginning of the current chapter/track.
- Press PREV (◀◀) twice briefly to step back to the previous chapter/track.
- To skip directly to any chapter/track during playback, press DISPLAY twice. Use ▲ / ▼ to select the Chapter icon (or for a Video CD, select the Track icon), then enter the desired chapter/track number using 0-9 or ◀ / ▶ and press ENTER.

Note

On a Video CD with PBC, you must set PBC to OFF in the DISC Settings menu to use this function. See page 25.

Slow Motion



- 1 Press REW (◀◀) or FF (▶▶) during Pause mode. The DVD Recorder+VCR will enter Slow Motion mode.
- 2 Use REW (◀◀) or FF (▶▶) to select the desired speed: ◀◀ 1/16, ◀◀ 1/8, ◀◀ 1/4, ◀◀ 1/2, or ▶▶ 1/16, ▶▶ 1/8, ▶▶ 1/4, ▶▶ 1/2.
With a Video CD, the Slow speed changes to: ▶▶ 1/8, ▶▶ 1/4 or ▶▶ 1/2 (forward).
- 3 To exit Slow Motion mode, press PLAY (▶).

Note

Slow motion playback in reverse is not possible with Video CDs.

DVD and Video CD Playback (Continued)

Playing a DVD or Video CD (Continued)

Still Picture and Frame-by-Frame Playback

DVD **Video** **VR** **VCD**

- 1 Press PAUSE/STEP (II) during playback.
The DVD Recorder+VCR will go into Pause mode.
- 2 You can back up or advance the picture frame-by-frame by pressing ◀ / ▶ repeatedly during Pause mode.

Note

Frame-by-frame reverse playback is not available on Video CDs.

Search **DVD** **Video** **VR** **VCD**

- 1 Press REW (◀◀) or FF (▶▶) during playback.
The DVD Recorder+VCR will go into Search mode.
- 2 Press REW or FF to select the desired speed: ▶▶X2, ▶▶X4, ▶▶X8, ▶▶X16, ▶▶X100, ▶ (forward) or ◀, ◀◀X2, ◀◀X4, ◀◀X8, ◀◀X16, ◀◀X100 (backward).
With a Video CD, the Search speed changes to: ◀◀X2, ◀◀X4, ◀◀X8 (backward) or ▶▶X2, ▶▶X4, ▶▶X8 (forward).
- 3 To exit Search mode, press PLAY (▶).

Note

When you press REW or FF during Search mode to resume normal speed, Search mode is canceled.

Random **Karaoke DVD**

- 1 Press RANDOM during Play mode.
The DVD Recorder+VCR automatically begins Random playback and "RANDOM" appears on the front panel display.
- 2 To return to normal playback, press RANDOM until "NORMAL" appears on the front panel display.

Tip

By pressing NEXT during Random playback, the DVD Recorder+VCR selects another title (track) and resumes Random playback.

Notes

- This function only works with DVD Karaoke discs or video CDs without PBC.
- On a Video CD with PBC, you must set PBC to OFF in the DISC Settings menu to use the Random function. See page 25.

Repeat **DVD** **Video** **VR** **VCD**



DVD Video Discs - Repeat Chapter/Title/Off

- 1 To repeat the currently playing chapter, press REPEAT.
REPEAT CHAPTER appears on the TV screen.
- 2 To repeat the currently playing title, press REPEAT a second time.
REPEAT TITLE appears on the TV screen.
- 3 To exit Repeat mode, press REPEAT a third time.
REPEAT OFF appears on the TV screen.

Video CDs - Repeat Track/All/Off

- 1 To repeat the track currently playing, press REPEAT.
The REPEAT TRACK icon appears on the TV screen.
- 2 To repeat the disc currently playing, press REPEAT a second time.
The REPEAT ALL icon appears on the TV screen.
- 3 To exit Repeat mode, press REPEAT a third time.
The REPEAT OFF icon appears on the TV screen.

Note

On a Video CD with PBC, you must set PBC to OFF in the DISC Settings menu to use the Repeat function. See page 25.

Repeat A-B



To repeat a sequence in a title:

- 1 Press A-B at your chosen starting point.
REPEAT A- appears on the TV screen.
- 2 Press A-B again at your chosen end point.
REPEAT A-B appears briefly on the TV screen, and the repeat sequence begins.
- 3 To cancel the sequence, press A-B repeatedly to select REPEAT OFF.

DVD and Video CD Playback (Continued)

Playing a DVD or Video CD (Continued)

Time Search **DVD** **Video** **VR**

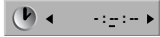

The Time Search function allows you to start playback from any chosen time on the disc.

- 1 Press DISPLAY during playback. The on-screen display appears on the TV screen.
The Time Search box shows the elapsed playing time of the current disc.
- 2 Within 7 seconds, use ▲ / ▼ to select the Time Search icon on the on-screen display.
“-:-:-” appears in the Time Search box.
- 3 Within 7 seconds, use the 0-9 buttons to enter the desired start time. Enter hours, minutes, and seconds from left to right in the box.
You cannot enter an invalid time.
If you enter an incorrect number, press ◀ / ▶ to move the cursor to the desired position, then re-enter the correct numbers.
- 4 Within 7 seconds, press ENTER to confirm the start time.
Playback starts from the selected time on the disc.

Zoom **DVD** **Video** **VR** **VCD**

The Zoom function allows you to magnify the video image and scroll around the enlarged image.

- 1 Press ZOOM during Play mode or Pause mode to activate the Zoom function.
A square frame will be displayed in the lower right corner of the screen. If no button is pressed for more than 5 seconds, the square frame will disappear.
Each press of the ZOOM button changes Zoom level as follows:
X1 (normal size) → X2 → X4 → X1 (normal size)
- 2 Use the ◀ ▶ ▲ ▼ buttons to scroll around the zoomed picture.
- 3 To resume normal playback, press CLEAR or press ZOOM repeatedly until the X1 (normal picture) appears.

Note

The Zoom function may not work on some DVDs.

Marker Search



You can bookmark up to six scenes during DVD or VCD playback and start playback from those scenes with the MARKER and SEARCH button.

- 1 During disc playback, press MARKER when you see the scene you want to bookmark.
The Marker icon will appear briefly on the TV screen.
- 2 Repeat step 1 to enter up to six bookmarks on a disc.

To Recall a Marked Scene

- 1 During disc playback, press SEARCH.
The Marker Search menu will appear on the TV screen.

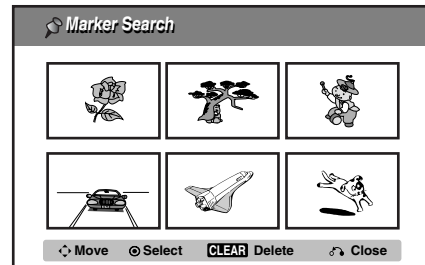

- 2 Use the ◀ ▶ ▲ ▼ buttons to select the Marked scene you want to recall.
- 3 Press ENTER.
Playback will start from the Marked scene.
- 4 To exit the Marker Search menu, press RETURN (↵).

To Clear a Marked Scene

- 1 During disc playback, press SEARCH.
The Marker Search menu will appear on the TV screen.
- 2 Use ◀ ▶ ▲ ▼ to select the Marked scene you want to erase.
- 3 Press CLEAR.
The message, “Delete selected marker. Continue?” appears.
- 4 Use ◀ / ▶ to select “Yes” then press ENTER.
- 5 Repeat steps 2-4 to erase additional Marked scenes.
- 6 To exit the Marker Search menu, press RETURN (↵).

Disc Menus **DVD**

Many DVDs contain Disc menus that allow you to access special features. To open a Disc menu, press DISC MENU. Then use the 0-9 buttons to directly select the desired option, or use the ◀ ▶ ▲ ▼ buttons to highlight your selection and press ENTER.

- 1 Press DISC MENU.
The Disc menu is displayed.
- 2 To exit the Disc menu, press STOP (■).

Title Menus **DVD**

- 1 Press TITLE.
If the current title has a menu, the Title menu will appear on the TV screen. Otherwise, the Disc menu may appear.
- 2 The Title menu may contain camera angles, spoken languages and subtitle options, as well as the chapters for the title.

DVD and Video CD Playback (Continued)

Playing a DVD (Continued)

Camera Angle **DVD** 1/3

If a DVD contains scenes recorded at different camera angles, you can select among these angles during playback.

- Press ANGLE then press ◀ / ▶ repeatedly during playback to select the desired angle.

The number of the current angle appears on the TV screen.



The Camera Angle icon is displayed on the TV screen when alternate angles are available.

Changing the Audio Language **DVD**

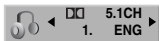

Press AUDIO then press ◀ / ▶ repeatedly during playback to hear a different audio language or audio track.

Changing the Audio Channel



With a Video CD, press AUDIO then press ◀ / ▶ repeatedly during playback to hear a different audio channel (STEREO, LEFT or RIGHT).

3D Surround **DVD** **Video** **VR** **VCD**



The DVD Recorder+VCR can produce a 3D Surround effect, which simulates multi-channel audio playback from two conventional stereo speakers.

- 1 Press DISPLAY twice then use ▲ / ▼ to select the Sound icon. Then, use ◀ / ▶ to select "3D SUR."
- 2 To turn off the 3D Surround effect, select "NORMAL."

Subtitles **DVD** OFF

Press SUBTITLE then press ◀ / ▶ repeatedly during playback to select among all available subtitle languages.

Finding Locations on a Disc **VCD**

Use the SEARCH button to access virtually any point during Video CD playback.

- 1 Press SEARCH during playback.
The progress bar appears on the TV screen.



- 2 Use ◀ / ▶ to find the desired starting position for playback.
- 3 Press ENTER to confirm the selected position.
Playback starts from the selected position.



This function will not work if any bookmarks have been set; see page 32.

Remember Disc Settings **DVD**

The DVD Recorder+VCR automatically memorizes the settings from the last disc you viewed. Settings remain in memory even if you remove the disc from the DVD Recorder+VCR or switch off the DVD Recorder+VCR. If you load a disc that had its settings memorized, the latest Stop position is automatically recalled.



- Settings are stored in memory for use at any time.
- The DVD Recorder+VCR does not memorize disc settings if you switch off the DVD Recorder+VCR before playing the disc again.
- This function may not work on some DVDs.

Audio CD and MP3 Operation

Playing an Audio CD or MP3 Disc

CD **MP3**

The DVD Recorder+VCR can play audio CDs and MP3 files on CD-ROM, CD-R or CD-RW discs. Before playing MP3 files, read “Notes on MP3 Recordings” at right.

- 1 Insert the disc and close the tray.**
The AUDIO CD or MP3 CD menu appears on the TV screen.

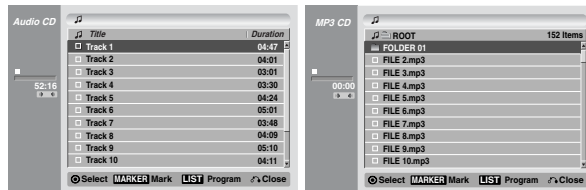

AUDIO CD Menu

MP3 CD Menu

- 2 Use ▲/▼ to select a track then press PLAY (▶).**
Playback starts.
During playback, the current track's elapsed playing time will appear on the front panel display and menu. Playback will stop at the end of the disc.

Tips

- If audio tracks and MP3 files are mixed on the disc, you can switch between the AUDIO CD menu and MP3 CD menu by pressing TITLE repeatedly in Stop mode.
- On the MP3 CD menu, you can display the folders on the disc. Use ▲▼◀▶ to select the Folder icon on the MP3 CD menu then press ENTER. Also, you can display only tracks in the folders. Use ▲▼◀▶ to select a folder then press ENTER.
- If you select a track and press DISPLAY, detailed file information is displayed. If you select a folder and press DISPLAY, the number of subfolders and number of MP3 files in the folder are displayed.
- If you are in a file list and want to return to the Folder list, use the ▲/▼ to highlight  and press ENTER to return to the previous menu screen.
- You can view TV channel or video input source by pressing RETURN. If you want to return to the MP3 or AUDIO CD menu, press DISC MENU/LIST.

- 3 To stop playback at any time, press STOP.**

Notes on MP3 Recordings

About MP3

- An MP3 file is audio data compressed using the MPEG1 audio layer 3 file-encoding scheme. Files that have the “.mp3” file extension are called “MP3 files”.
- The DVD Recorder+VCR cannot read MP3 files that have file extensions other than “.mp3”.

MP3 Disc compatibility with the DVD Recorder+VCR is limited as follows:

1. CD-R/RW physical format should be “ISO 9660” and “JOLIET”.
2. If you record MP3 files using software which cannot create a FILE SYSTEM (e.g., Direct-CD, etc.), it is impossible to playback MP3 files. “Easy-CD Creator” is recommended.
3. The total number of files and folders on the disc are free but the total number of files and folders on the folder should be less than 1999.

This DVD Recorder+VCR requires discs/recordings to meet certain technical standards in order to achieve optimal playback quality. Pre-recorded DVDs are automatically set to these standards. There are many different types of recordable disc formats (including CD-R containing MP3 files) that require certain pre-existing conditions (see above) to insure compatible playback.

Please note that permission is required in order to download MP3 files and music from the Internet. Our company has no right to grant such permission. Permission should always be sought from the copyright owner.

Audio CD and MP3 Operation (Continued)

Pause **CD** **MP3**

- 1 Press PAUSE/STEP during playback.
- 2 To return to playback, press PLAY (▶) or press PAUSE/STEP again.

Skip Tracks **CD** **MP3**

- Press PREV (◀◀) or NEXT (▶▶) briefly during playback to go to the next track or to return to the beginning of the current track.
- Press PREV (◀◀) twice briefly to step back to the previous track.
- To skip directly to any track during Audio CD playback, enter the track number using the 0-9 buttons.

Repeat **CD** **MP3**

Press REPEAT to select the desired Repeat mode.

- CD
 - TRACK: Repeats the current track.
 - ALL: Repeats all tracks on the disc.
 - OFF: Cancels Repeat mode (no display).
- MP3
 - TRACK: Repeats the current track.
 - FOLDER: Repeats all tracks in the selected folder.
 - OFF: Cancels Repeat mode (no display).

Random **CD** **MP3**

- 1 Press RANDOM during Play or Stop mode.
The DVD Recorder+VCR automatically begins Random Playback and RANDOM appears on the menu screen.
- 2 To return to normal playback, press RANDOM again, then RANDOM disappears from the menu screen.

Search **CD**

- 1 Press REW or FF during playback.
The DVD Recorder+VCR will go into Search mode.
- 2 Press REW or FF to select the desired speed: ◀◀X2, ◀◀X4, ◀◀X8 (backward) or ▶▶X2, ▶▶X4, ▶▶X8 (forward).
Search speed and direction are indicated on the menu screen.
- 3 To exit Search mode, press PLAY (▶).

Repeat A-B **CD**

To repeat a sequence in a track:

- 1 Press A-B at your chosen start point.
The Repeat icon and "A" appear on the menu screen.
- 2 Press A-B again at your chosen end point.
The Repeat icon and "A - B" appear on the menu screen, and the repeat sequence begins.
- 3 To exit the sequence and return to normal play, press A-B again.
The Repeat icon disappears from the menu screen.

Program Playback with Audio CD and MP3

Program Playback enables you to make custom playlists of Audio CD or MP3 tracks. Programs can contain up to 99 Audio CD tracks or 256 MP3 tracks.

1 Insert an Audio CD or MP3 disc.
The Audio CD or MP3 CD menu will appear.

2 Use ▲ ▼ to select a track on the list then press ENTER.
The options appear on the left side of the menu.

Note

- Press and hold ▼ to move quickly to the next track or folder.
- Press and hold ▲ to move quickly to the previous track or folder.

3 Use ▲ ▼ to highlight Program Add then press ENTER.
The selected track is added to the Program List.

4 Repeat steps 2-3 to place additional tracks in your Program list.

Tip

To add multiple tracks to your Program List:

1. Select a track then press MARKER.
2. Repeat step 1 to mark additional tracks.
3. Select any marked track then press ENTER.
The options appear on the left side of the menu.
4. Use ▲ / ▼ to highlight Program Add then press ENTER.
All marked tracks are added to your Program List.

Notes

- Use the CLEAR button to select all tracks, or cancel all marked tracks.
- If you select folder for Programmed Playback, all tracks in the folder are added to the program list.

5 Use ► to move to the Program list.
The programmed track you selected last is highlighted on the program list.

6 Use ▲ / ▼ to select the track you want to start playing.

7 Press PLAY (▶) to start.
Playback begins in the programmed order and "PRG" appears on the front panel display.
Playback stops after playing the last programmed track in the program list.

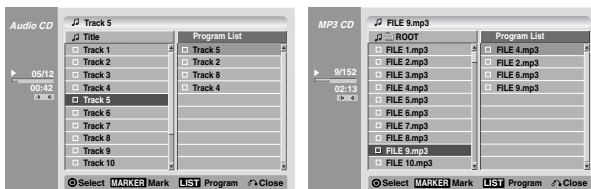

8 To exit Program Playback and resume normal playback, select a track on the List and press PLAY (▶) .

"PRG" indicator disappears from the front panel display.

Repeat Programmed Tracks

Press REPEAT to select the desired Repeat mode.

- TRACK : Repeats the current track.
- ALL : Repeats all tracks on the disc.
- OFF : Cancels Repeat mode (no display).

Erasing a Track from the Program List

1 Select the track you wish to erase from the Program List then press ENTER.
The options appear on the left side of the menu.

2 Select Delete then press ENTER.
The selected track is deleted from the Program List.

3 Repeat steps 1-2 to delete additional tracks from the Program List.

Erasing multiple tracks from the Program List

1 Select a track on the Program List then press MARKER.

2 Repeat step 1 to mark additional tracks.

3 Select any marked track then press ENTER.
The options appear on the left side of the menu.

4 Use ▲ / ▼ to highlight Delete then press ENTER.
All marked tracks are deleted from the Program List.

Changing Track Order in the Program List

1 Select the track you wish to move on the Program List then press ENTER.
The options appear on the left side of the menu.

2 Select Move then press ENTER.
A yellow bar appears in the Program List.

4 Use ▲ / ▼ to move the yellow bar to the desired location, then press ENTER.
The selected track is moved.

Tip

Use MARKER to move multiple tracks.

JPEG Disc Operation

Viewing a JPEG Disc **JPEG**

The DVD Recorder+VCR can play discs with JPEG files. Before playing JPEG recordings, read "Notes on JPEG Recordings" at right.

- 1 Insert a disc and close the tray.**
The Photo menu appears on the TV screen.

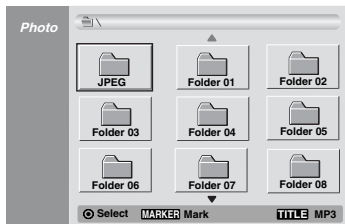

- 2 Use ▲▼◀▶ to select a folder, then press ENTER.**
The Open icon is highlighted on the left side of the menu.

- 3 Press ENTER.**
A list of files in the selected folder appears.



Note

If the  icon displays in a JPEG file list, it means you cannot see those JPEG files.

- 4 Use ▲▼◀▶ to select a file, then press ENTER.**
The options appear on the left side of the menu.

Tip

If you are in a file list and want to return to the Folder list, use the ▲ / ▼ buttons on the remote to highlight the  icon and press ENTER.

- 5 Use ▲ / ▼ to select "Full Screen" then press ENTER.**

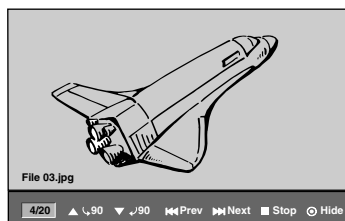

- 6 To stop viewing at any time, press STOP or RETURN (⏮).**

The Photo menu reappears.

Skip Images

While viewing a picture, press PREV (◀◀) or NEXT (▶▶) once to advance to the next file or return to the previous file.

Rotate Images

Use ▲ / ▼ while viewing a picture to flip the picture clockwise or counterclockwise.

View Slide Shows

- Select Slide Show on the Photo menu.
- Press ENTER.
The Slide Show menu appears.

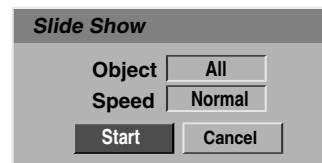

- Use ▲▼◀▶ to set the options.
Object: Selected file or All files.
Speed: Sets the Slide Show speed to Slow, Normal, Fast.
- Select the Start icon then press ENTER to start the Slide Show.
- Press STOP to stop the Slide Show and return to the Photo menu.

Note

Use the MARKER button to select multiple files.

Notes on JPEG Recordings

- Depending on the size and number of JPEG files, it may take several minutes for the DVD player to read the disc's content. If you don't see an on-screen display after several minutes, some of the files are too big — reduce the resolution of the JPEG files to less than 4 megapixels and burn another disc.
- The total number of files and folders on the disc are free but the total number of files and folders on the folder should be less than 1999.
- Some discs may be incompatible due to different recording formats or the condition of the discs.
- When you are using software such as "Easy CD Creator" to burn JPEG files on a CD-R, ensure that all selected files have the ".jpg" extension before copying them into the CD layout.
- If the files have ".jpe" or ".jpeg" extensions, please rename them as ".jpg" files.
- File names without the ".jpg" extension cannot be read by this DVD player, even though the files are shown as JPEG image files in Windows Explorer®.
- On CDs with mixed content (audio tracks, MP3 files and JPEG files), you can select among the AUDIO CD menu, MP3 CD menu, and Photo CD menu by pressing TITLE repeatedly in Stop mode.

VCR Playback

Before You Begin

- Press the VCR button to set the remote control to operate the VCR deck.
- Turn the TV on and select the video input source connected to the DVD Recorder+VCR.
- Audio system: Turn the audio system on and select the input source connected to the DVD Recorder+VCR.

Playing a VHS Tape **VHS**

Preparation:

- Turn on the TV.
- Tune the TV to the DVD Recorder+VCR output channel (CH 3 or 4) or select the video input connected to the DVD Recorder+VCR.

1 Insert a prerecorded video cassette.

The  indicator will light and the DVD Recorder+VCR will power up automatically.

- Make sure the TIMER indicator on the front panel display is not lit. If it is, press **POWER** once.
- If a tape without a safety tab is inserted, the DVD Recorder+VCR will start playback automatically.

2 Press **PLAY** (▶).

PLAY icon appears on the TV screen.

- It is not necessary to select the tape speed for playback. It will be automatically selected by the DVD Recorder+VCR.
- During playback, the **TV/VCR** selector switches to VCR mode automatically.

3 Press **STOP** (■) to stop playback.

STOP icon appears on the TV screen.

- If the tape reaches the end before **STOP** (■) is pressed, the DVD Recorder+VCR will automatically stop, rewind, eject the tape, and turn itself off.

Tracking Control **VHS**

Auto Tracking

The automatic tracking function adjusts the picture to remove snow or streaks. It works in the following cases:

- When a tape is played for the first time.
- When the tape speed (SP, LP, SLP) changes.
- When streaks or snow appear because of scratches on the tape.

Manual Tracking

If noise appears on the screen during playback, press either **TRACK (+/-)** on the remote control or **CH (▲/▼)** on the front panel until the noise on the screen is reduced.

- In case of vertical jitter, adjust these controls very carefully.
- Tracking is automatically reset to normal when the tape is ejected or the power cord is unplugged for more than 3 seconds.

Special Playback Features **VHS**



Notes on special playback features

- Horizontal lines (noise bars) will appear on the TV screen. This is normal.
- The audio is automatically muted during special playback modes, so there is no sound during search, slow motion, etc.
- During high-speed picture search, a short time is needed to stabilize tape speed when re-entering Play mode. Slight interference may be observed during this time.

Search

This function lets you visually search forward and backward for a desired scene on your tape.

- 1 Press **REW** (◀◀) or **FF** (▶▶) during playback. Search mode will be activated.

- If the DVD Recorder+VCR is left in Search mode for more than 3 minutes, the DVD Recorder+VCR will automatically enter Play mode to protect the tape and video heads.

- 2 To return to normal playback, press **PLAY** (▶).

Still Picture and Frame-by-Frame Playback

- 1 Press **PAUSE/STEP** (||) during playback. A still picture appears on the TV screen.

- If a still picture vibrates vertically, stabilize it by using **TRACK (+/-)** on the remote control.
- If the DVD Recorder+VCR is left in Still mode for more than 5 minutes, the DVD Recorder+VCR will automatically enter Stop mode to protect the tape and video heads.

- 2 Press **PAUSE/STEP** (||) repeatedly to advance the video picture one frame at a time while viewing a still picture.

- 3 To return to normal playback, press **PLAY** (▶).

Slow Motion

- 1 While in Still mode, press **FF** (▶▶).

The tape will be played back at a speed 1/19 times slower than normal speed.

- During Slow Motion playback, use **TRACK (+/-)** on the remote control to minimize noise.
- If Slow Motion mode continues for more than 3 minutes, the DVD Recorder+VCR will automatically change to normal Play mode.

- 2 To return to normal playback, press **PLAY** (▶).

Counter Memory Function

This is useful if there is a section of tape you want to view immediately after recording or if you want to return to the same point several times.

- 1 Begin recording or playing a tape.
- 2 Press **DISPLAY** repeatedly to display the real-time counter on the TV screen.
- 3 At the point you want to locate later, reset the real-time counter to 0:00:00 by pressing **CLEAR**. Continue to play or record.
- 4 Press **STOP** when recording or playback finishes.
- 5 Press **RETURN** (↺).

The tape automatically stops when the tape counter returns to about "0:00:00".

Basic Recording

Recording from TV

Follow the instructions below to record a TV program.

1 Turn on the DVD Recorder+VCR and load a recordable disc or tape.

Make sure your TV input is set to view the DVD Recorder+VCR.

- If you load a blank DVD-RW disc, you will be prompted to set the DISC Record mode. Choose VR mode for maximum editing options or Video mode for maximum compatibility with other DVD players; see page 24.

2 Set the desired Recording mode by pressing REC MODE repeatedly.

DVD: SP (Standard Quality - 2hrs/disc), LP (Low Quality - 4 hrs/disc), XP (High Quality - 1 hr/disc)

VCR: SP (Standard Play), SLP (Super Long Play - 3 times SP)

3 Use the CH (▲ / ▼) buttons to select the TV channel you wish to record.

4 Press AUDIO to select the audio channel to record (Stereo, SAP, or Mono).

The table below shows what audio channel will be recorded with different settings and different types of broadcasts. The last column (Monitor Audio) shows what you will hear during recording. For example, if the TV broadcast is in Stereo, then setting the DVD Recorder+VCR to Stereo will record the broadcast in Stereo, and the Monitor Audio will also be in Stereo.

- If you set the audio channel to SAP, but no SAP channel is broadcast, the main audio (Mono or Stereo) will be recorded.

TV Broadcast	Selected Audio	Broadcast Audio		Monitor Audio
		L Ch	R Ch	
MONO	MONO	MONO	MONO	MONO
STEREO	STEREO	L	R	STEREO
	Left	L	L	Left
	Right	L	R	Right
MONO+SAP	MONO	MONO	MONO	MONO
	SAP	SAP	SAP	SAP
STEREO+SAP	STEREO	L	R	STEREO
	SAP	SAP	SAP	SAP
	MONO	MONO	MONO	MONO

5 Press REC (●) once.

Recording will start. The REC indicator lights on the front panel display.

- Recording continues until you press STOP (■) or the disc is full.
- To record for a fixed length of time, see One Touch Record at right.

6 Press STOP (■) to stop recording.

Note

- The maximum number of DVD titles is 99.
- If the DVD Recorder+VCR is powered off during DVD recording, the recording will not be saved.

One Touch Record (OTR)

One Touch Recording allows you add recording time in fixed increments at the touch of a button.

1 Follow steps 1-4 under Recording from TV.

2 Press REC (●) repeatedly to set the length of the recording.

Recording starts after the first press. Each subsequent press increases the recording time by 10 minutes (DVD, to a maximum of 240 minutes) within the available space or 30 minutes (VCR, to a maximum of 540 minutes).

The recording time is displayed on the TV screen.

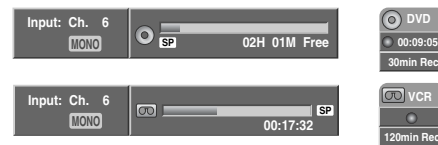

One Touch Recording Menu

Checking the Recording Time

Press REC (●) or DISPLAY to show the elapsed recording time on the on-screen display.

The remaining recording time is shown on the front panel display.

To Extend the Recording Time

The recording time can be extended anytime by pressing REC (●). Each subsequent press increases the recording time by 10 minutes (DVD) within the available space or 30 minutes (VCR).

To Pause the Recording

- 1 Press PAUSE/STEP (||) to pause the disc during recording.
- 2 When you want to continue recording, press PAUSE/STEP (||) or REC (●).

Notes

- If you press PAUSE/STEP (||) during One Touch Recording, it will be canceled.
- The DVD Recorder+VCR will automatically power off when the One Touch Recording ends.

To record one TV program while watching another

- 1 Press TV/VCR to select TV mode during recording. The VCR indicator disappears.
- 2 Select the channel you wish to view on your TV.

Tip (VCR mode only)

Always use PAUSE/STEP (||) for best results when making changes during recording.

For example: To change channels during recording, first press PAUSE/STEP (||) to put the unit in Pause mode. Then select the desired channel on the DVD Recorder+VCR, and press PAUSE/STEP (||) again to resume recording.

Basic Recording

One Touch Copy - DVD to VHS

You can copy the contents of a DVD to a VHS tape using the COPY button.

Note

If the DVD you are attempting to copy is copy-protected, you will not be able to copy the disc. It is not permitted to copy Macrovision encoded DVDs. "Copy-protected. Cannot record." is displayed on the TV screen.

- 1 Insert a Disc**
Insert the disc you wish to copy in the DVD deck and close the disc tray.
- 2 Insert a VHS Tape**
Insert a blank VHS videotape into the VCR deck.
- 3 Select DVD mode by pressing DVD on the remote control or pressing DVD/VCR on the front panel.**
- 4 Find the place on the DVD (or Disc) from which you want to start recording using the PLAY and PAUSE functions.**
For best results, pause playback at the point from which you want to record.
- 5 Press the COPY button on the remote control or front panel.**
The Copy to VCR menu appears.

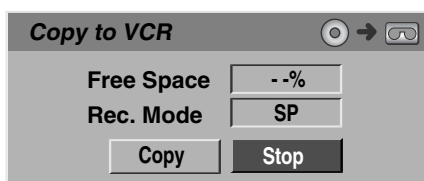

- 6 Use ▲ / ▼ / ◀ / ▶ to select the desired Record Mode:**
 - SP (Standard Play)
 - SLP (Super Long Play, 3 times SP).
- 7 Select Copy then press ENTER or COPY to start copying.**

Tip

If you press PAUSE during Copy mode, both the DVD and VCR decks go into Pause mode and the "COPY" indicator blinks on the front panel display. While in Pause mode, you can adjust the DVD playback position using PLAY, REW, FF, PAUSE/STEP, etc. The VCR deck will remain in Pause mode. To resume copying, press the COPY button twice.

- 8 Stop the Copy Process**
To stop copying at any other time, press STOP (■). You must stop the Copy process manually when the DVD movie ends, or the unit may replay and record over and over again.

One Touch Copy - VHS to DVD

You can copy the contents of a VHS tape to a DVD-R or DVD-RW using the COPY button. This allows you to archive your old VHS tapes to DVD.

Note

If the VHS videotape you are attempting to copy is copy-protected, you will not be able to copy the tape. It is not permitted to copy Macrovision encoded tapes.

- 1 Insert a VHS Tape**
Insert the VHS videotape you wish to copy into the VCR deck.
- 2 Insert a DVD-R or DVD-RW disc.**
Insert a blank DVD-R or DVD-RW disc in the DVD deck and close the disc tray.
- 3 Select VCR mode by pressing VCR on the remote control or pressing DVD/VCR on the front panel.**
- 4 Find the place on the VHS tape from which you want to start recording using the PLAY, FF, REW and PAUSE functions.**
For best results, pause playback at the point from which you want to record.
- 5 Press the COPY button on the remote control or front panel.**
The Copy to DVD menu appears.



- 6 Use ▲ / ▼ / ◀ / ▶ to select the desired Record Mode:**
 - LP (Low Quality, 4 hrs/disc)
 - SP (Standard Quality, 2 hrs/disc)
 - XP (High Quality, 1 hr/disc)
- 7 Select Copy then press ENTER or COPY to start copying.**

Tip

If you press PAUSE during Copy mode, both the DVD and VCR decks go into Pause mode and the "COPY" indicator blinks on the front panel display. While in Pause mode, you can adjust the VCR playback position using PLAY, REW, FF, PAUSE/STEP, etc. The DVD deck will remain in Pause mode. To resume copying, press the COPY button twice.

- 8 Stop the Copy Process**
To stop copying at any other time, press STOP (■). Copying will stop automatically when the VHS tape ends.

Timer Recording

The Timer Recording function allows you to record up to 8 programs within a period of one month.

- 1 **Press TIMER RECORD.**
The Timer Record menu appears.

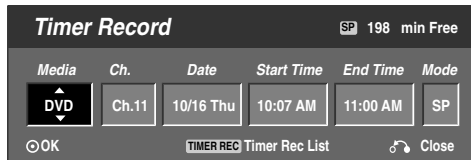

- **Media** – Choose the desired media (DVD or VCR).
- **Ch.** – Choose the desired channel, or one of the external inputs from which to record.
- **Date** – Choose a date up to 1 month in advance, or select a daily or weekly program.
- **Start Time** – Set the recording start time.
- **End Time** – Set the recording end time.
- **Mode** – Choose a Record mode.
DVD: SP, LP, XP, or AT (Auto)
VCR: SP, SLP, AT (Auto)
AUTO mode determines how much time is available on the disc or tape and switches the Record mode, if necessary, to complete recording the program.

- 2 **Enter the necessary information for your Timer Recording(s).**

- ◀ / ▶ (left/right) – Moves the cursor left/right
- ▲ / ▼ (up/down) – Changes the setting at the current cursor position
- Press RETURN to exit the Timer Record menu.
- Press ENTER after filling in all the program information.
- Press TIMER RECORD to display the Timer Record List.

- 3 **Press ENTER to save the program.**
The Timer Record List will appear.

- 4 **Press RETURN (↵) to exit the Timer Record List.**

- 5 **Be sure to load a recordable disc or tape.**

Note

- The Timer indicator lights on the front panel display.
- If the Disc and Tape indicator are blinking, either no disc or tape is loaded, or the loaded disc is not recordable.
- The DVD Recorder+VCR will record the audio according to the current TV tuner setting (Stereo, Mono or SAP). Use the AUDIO button to set the audio before switching the DVD Recorder+VCR to Standby mode.
- You must press STOP to stop the Timer Recording.
- The DVD Recorder+VCR will automatically power off when the Timer Recording ends.
- There is a short delay when a timer recording finishes to confirm the recorded program. If two timer recordings are set to record sequentially (one right after the other), the very beginning of the later program may not be recorded.

Checking Timer Recording Details

Press TIMER RECORD twice to check your Timer Recording settings.

- Use ▲ / ▼ to select a program.
- Press **ENTER** to edit the selected program.
The Timer Record menu appears.
- Press **CLEAR** to delete the selected program from the Timer Record List.



Canceling a Timer Recording

You can clear a Timer Recording any time before the recording actually starts.

- Use ▲ / ▼ to select the program you want to erase on the Timer Recorder List, then press CLEAR.

Stopping a Timer Recording in Progress

After a Timer Recording has started, you can still cancel the program by pressing STOP.

Timer Recording Troubleshooting

Even if a Timer Recording is set, the DVD Recorder+VCR will not record if:

- No disc is loaded.
- A non-recordable disc is loaded.
- DISC Protect is set to ON in the DISC Settings menu; see page 25.
- There are already 99 titles recorded on the disc.

You cannot enter a Timer Recording if:

- A recording is already underway.
- The start time has already passed.
- Eight Timer Recordings have already been set.

If two or more Timer Recordings overlap:

- The earlier program takes priority.
- When the earlier program finishes, the later program starts.
- If two programs are set to start at exactly the same time, the program entered first takes priority.

Confirmation is not possible when:

- The DISC Protect setting is set to ON.
- There are already 99 titles recorded on the disc.

If the disc is damaged, the recording may not complete successfully, even if the Check field shows "Rec. OK".

Recording from an External Input

Recording from External Components

You can record from an external component, such as a camcorder or VCR, connected to any of the DVD Recorder+VCR's external inputs.

1 Make sure the component you want to record from is connected properly to the DVD Recorder+VCR; see page 17.

2 Press INPUT repeatedly to select the external input to record from.

- Tuner: Built-in tuner
- AV1: Audio/Video Input on back panel
- AV2 (AV2 COMP) : Audio/Video or S-Video Input on front panel
- DV: DV Input on front panel

Note

Check that the Audio In settings under DV Record Audio are as you want them; see page 24.

3 Load a recordable disc or tape.

4 Set the desired Recording mode by pressing REC MODE repeatedly.

DVD: SP (Standard Quality - 2hrs/disc), LP (Low Quality - 4 hrs/disc, XP (High Quality - 1 hr/disc)

VCR: SP (Standard Play), SLP (Super Long Play - 3 times SP)

5 Press REC (●) once.

Recording will start. The REC indicator lights on the front panel display.

- Recording continues until you press STOP (■) or the disc is full.
- To record for a fixed length of time, see "One Touch Record" on page 39.

6 Press STOP (■) to stop recording.

Note

If your source is copy-protected, you will not be able to record it using the DVD Recorder+VCR. See "Copyright Notice" on page 8 for more details.

Recording from a Digital Camcorder

You can record from a digital camcorder connected to the DV IN jack on the front panel of the DVD Recorder+VCR. You can use the DVD Recorder+VCR remote to control both the camcorder and the DVD Recorder+VCR. Before recording, make sure that the audio input for the DV IN jack is set up; see page 24.

Tips

- The source signal must be DVC-SD format.
- Some camcorders cannot be controlled using the DVD Recorder+VCR remote.
- If you connect a second DVD recorder using a DV cable, you cannot control the second recorder from this one.
- You cannot control the DVD Recorder+VCR remotely from a component connected to the DV IN jack.
- You cannot record date and time information from a DV cassette.

1 Make sure your digital camcorder is connected to the front panel DV IN jack; see page 17.

2 Make sure DV Record Audio is set correctly.

Choose between Audio 1 (original audio) and Audio 2 (overdubbed audio); see page 24 for details.

3 Press INPUT repeatedly to select the DV input.

DV appears on the front panel display and on the TV screen.

4 Find the place on the camcorder tape from which you want to start recording.

For best results, pause playback at the point you want to start recording.

- Depending on your camcorder, you can use the DVD Recorder+VCR remote to control the camcorder using the STOP, PLAY and PAUSE functions.

5 Press REC (●) once to start recording.

- Recording is automatically stopped if the DVD Recorder+VCR detects no signal.
- You can pause or stop the recording by pressing PAUSE/STEP or STOP. You cannot control the camcorder from the remote control during recording.
- In Video mode, the final frame of the recording may remain displayed on screen for a while after recording stops.

Playing Recordings on Other DVD Players

Most regular DVD players can play finalized discs recorded in Video mode. A small number of players can also play DVD-RW discs recorded in VR mode, finalized or not. Check the manual that came with the other player to check what kinds of discs it will play.

Finalizing a Disc

Finalizing 'fixes' the recordings in place so that the disc can be played on a regular DVD player or computer equipped with a suitable DVD-ROM drive. Finalizing a Video mode disc creates a menu screen for navigating the disc. This is accessed by pressing DISC MENU or TITLE. To finalize a disc, refer to "DISC Finalize" on page 25.

Recording from an External Input (Continued)

What is DV?

Using DV, also known as i.LINK, you can connect a DV-equipped camcorder to the DVD Recorder+VCR using a single DV cable for input and output of audio, video, data and control signals.

The i.LINK interface is also known as IEEE 1394-1995. "i.LINK" and the "i.LINK" logo are trademarks.

- The DVD Recorder+VCR is only compatible with DV-format (DVC-SD) camcorders. Digital satellite tuners and Digital VHS video recorders are not compatible.
- You cannot connect more than one DV camcorder at a time to the DVD Recorder+VCR.
- You cannot control the DVD Recorder+VCR from external equipment connected via the DV IN jack (including two DVD Recorders).
- It may not always be possible to control the connected camcorder via the DV IN jack.
- Digital camcorders can usually record audio as stereo 16-bit/48kHz, or twin stereo tracks of 12-bit/32kHz. The DVD Recorder+VCR can only record one stereo audio track. Set DV Record Audio to Audio 1 or Audio 2 as desired; see page 24.
- Audio input to the DV IN jack should be 32 or 48kHz (not 44.1kHz).
- Picture disturbance on the recording may occur if the source component pauses playback or plays an unrecorded section of tape, or if the power fails in the source component, or if the DV cable becomes disconnected.
- If DV Record Audio is set to Audio 2 and the Audio 2 signal is not present, DV Record Audio will be reset to Audio 1 automatically.

DV-Related Messages

You may see the following messages appear on your TV screen when using the DV IN jack.

Camcorder not connected

The camcorder is not connected properly, or the camcorder is switched off.

Too many devices connected

The DV jack on the DVD Recorder+VCR supports connection to just one camcorder.

Check tape

There is no cassette loaded in the connected equipment.

Uncontrollable device

The DVD Recorder+VCR cannot control the camcorder. Try switching off the camcorder then switching it back on.

Updating device information

The camcorder is updating information for DV.

Camera Mode

The camcorder is set to camera mode.

Troubleshooting

If you cannot get a picture and/or audio through the DV IN jack, check the following:

- Make sure the DV cable is properly connected.
- Try switching off the connected equipment then switching it back on.
- Try switching the audio input.

Note

Depending on the connected camcorder, you may not be able to control it using the remote control supplied with the DVD Recorder+VCR.

VR Mode: Original and Playlist Editing

In this section, you will learn about editing DVD-RW discs in VR Mode.

It is important to understand the difference between edits to the Original content of the disc and edits to the Playlist. Edits you make to the Original content of a disc change the actual content of the disc. For example, if you erase a title or chapter from the Original content, that title or chapter is erased from the disc, freeing up extra recording time.

When you edit the Playlist, however, you are not changing the content of the disc. For example, when you erase a title from the Playlist (Program), you are just telling the DVD Recorder+VCR not to play that title; nothing is actually erased from the disc.

Titles and Chapters **VR**

Titles in the disc's Original content contain one or more chapters. When you insert an Original title into the Playlist (Program), all the chapters within that title also appear. In other words, chapters in the Playlist behave exactly as chapters on a DVD disc.

Adding a title or chapter to the Playlist creates a new title made up of chapters of the Original title. Erasing a chapter removes that chapter from the Original or Playlist (Program).

Caution

- When editing using the Erase, Add and Move functions, the start and end frames may not be exactly as set in the start and end point display.
- During Playlist playback, you may notice a momentary pause between edits. This is not a malfunction.

Adding Chapter Markers **VR**



You can add a chapter marker anywhere in a Playlist or Original title during recording or playback.

Once the chapter is marked, you can use the Chapter Search feature, as well as erase, combine and move chapters in the Original (Chapter) or Playlist (Chapter) menu.

You can insert up to 999 chapter markers in both the Original and Playlist contents.

1 Play the title (Original or Playlist).

2 At the point you want to start a new chapter, press **ADD CHAP**.

A Chapter Marker icon appears on the TV screen.

- You can also add chapter markers during recording.

Changing Title or Chapter Thumbnails



Each title and chapter displayed in the Original or Playlist menu is represented by a thumbnail picture taken from the start of that title or chapter. If you prefer, select a different still picture from within a title.

1 Play the title (Original or Playlist).

2 Press **THUMBNAIL** to make the currently displayed picture the one that appears in the Original or Playlist menu.

The still picture that you choose appears in both the Original (Title) and Playlist (Title) menu.

Tip

You can also change the thumbnail picture of the title on the Original (Chapter) or Playlist (Chapter) menu. Select a chapter on the Original (Chapter) or Playlist (Chapter) menu then press **THUMBNAIL**. The thumbnail picture of the title that includes the chapter is changed.

VR Mode: Original and Playlist Editing (Continued)

Using the Original (Title) Menu **VR**

The Original (Title) menu is where you build and edit your Playlist, and where you can erase titles and make other changes to the Original content of the disc. You can also play individual titles directly from the Original (Title) menu.

1 Press DISC MENU/LIST repeatedly to display the Original (Title) menu.

- Use the ▲ / ▼ buttons to display the previous/next page if there are more than 6 titles.
- To exit the menu, press RETURN (↵).

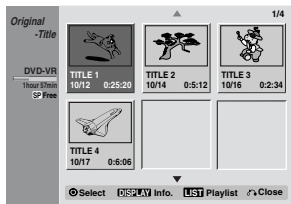

Note

To switch between the Original (Title) and Playlist (Title) menu, press DISC MENU/LIST repeatedly. The Original and Playlist heading at the top of the screen indicate which mode you are in.

2 To view Original (Title) options, select the title you want then press ENTER.

Title List options appear on the left side of the Title List display.

3 Use ▲ / ▼ to select an option then press ENTER to confirm.

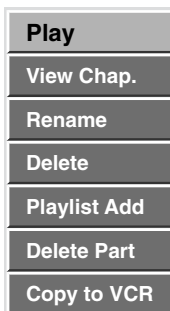

Play: Starts playback of the selected title.

View Chap.: Moves to Original (Chapter) menu; Refer to right column on this page.

Rename: Edits the title name; see page 47.

Delete: Deletes the title from the Original (Title) menu; see page 48.

Playlist Add: Adds the title to the Playlist; see page 48.

Delete Part: Deletes a part of the Title; see page 50.

Copy to VCR: Copies the title to a VHS tape.

4 Press RETURN (↵) repeatedly to exit the Original (Title) menu.

Tip

Press DISPLAY to display more detailed title information for the selected title.

Using the Original (Chapter) Menu

VR

1 Press DISC MENU/LIST repeatedly to display the Original (Title) menu.

2 Use ▲ ▼ ◀ ▶ to choose the title you want to view on the Original (Title) menu then press ENTER.

The options appear on the left side of the Original (Title) menu.

3 Use ▲ / ▼ to select 'View Chap.' from the Original (Title) options then press ENTER.

The Original (Chapter) menu appears on the TV screen.

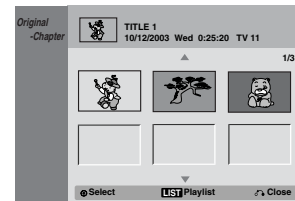

4 Use ▲ / ▼ to select a chapter then press ENTER to confirm.

The options appear on the left side of the Original (chapter) menu.



Play: Starts playback of the selected chapter.

View Title: Moves to the Original (Title) menu; Refer to left column on this page.

Delete: Deletes the chapter from the Original (Chapter) menu; see page 48.

Merge: Merges two chapters into one; see page 49.

Playlist Add: Adds the chapter to the Playlist; see page 48.

5 Press RETURN (↵) repeatedly to exit the Original (Chapter) menu.

VR Mode: Original and Playlist Editing (Continued)

Using the Playlist (Title) Menu **VR**

- 1 Press DISC MENU/LIST repeatedly to display the Playlist (Title) menu.
 - Use the ▲ / ▼ buttons to display the previous/next page if there are more than 6 titles/chapters.
 - To exit the menu, press RETURN (↵).

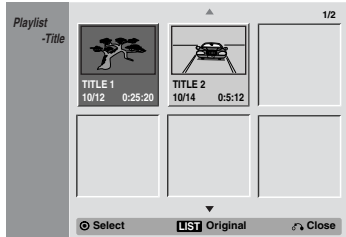

- 2 Use ▲▼◀▶ to choose a title then press ENTER.
Playlist options appear on the left side of the Playlist (Title) screen.

- 3 Use ▲ / ▼ to select an option then press ENTER to confirm.

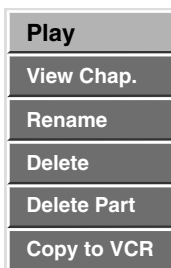

Play: Starts playback of the selected title.

View Chap.: Moves to the Playlist (Chapter) menu; Refer to right column on this page.

Rename: Edits the title name; see page 47.

Delete: Deletes the title from the Playlist (Title) menu; see page 48.

Delete Part: Deletes a part of the Title; see page 50.

Copy to VCR: Copies the title to a VHS tape.

- 4 Press RETURN (↵) repeatedly to exit the Playlist (Title) menu.

Using the Playlist (Chapter) Menu **VR**

- 1 Press DISC MENU/LIST repeatedly to display the Playlist (Title) menu.
- 2 Use ▲▼◀▶ to choose the title you want to view on the Playlist (Title) menu then press ENTER.
The options appear on the left side of the Playlist (Title) menu.
- 3 Use ▲ / ▼ to select 'View Chap.' from the Playlist (Title) options then press ENTER.
The Playlist (Chapter) menu appears on the TV screen.

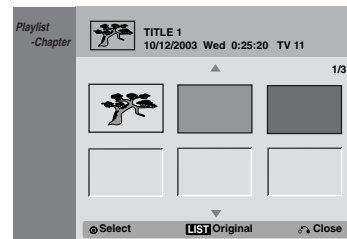

- 4 Use ▲ / ▼ to select a chapter then press ENTER to confirm.
The options appear on the left side of the Original (Chapter) menu.



Play: Starts playback of the selected chapter.

View Title: Moves to the Original (Title) menu; Refer to left on this page.

Delete: Deletes the chapter from the Original (Chapter) menu; see page 48.

Move: Moves a chapter of the Playlist (Chapter) to a position within the title; see page 48.

Merge: Merges two chapters into one; see page 49.

- 5 Press RETURN (↵) repeatedly to exit the Playlist (Chapter) menu.

VR Mode: Original and Playlist Editing (Continued)

Naming a Title **VR**

You can name Original and Playlist titles independently. Names can be up to 32 characters long.

1 Press **DISC MENU/LIST** repeatedly to display the **Original (Title)** or **Playlist (Title)** menu.

2 Use **▲▼◀▶** to choose the title you want to name then press **ENTER**.

The **Original (Title)** or **Playlist (Title)** options appear on the left side of the menu.



Original (Title)

Playlist (Title)

3 Use **▲/▼** to select the 'Rename' option then press **ENTER**.

The Keyboard menu appears.



4 Enter a name for the title. Use **▲▼◀▶** to select a character then press **ENTER** to confirm your selection. Refer step 5 as shown on page 26 (DISC Name).

5 Choose **OK** then press **ENTER** to save the name and return to the Disc menu screen.

6 Press **RETURN** (↵) repeatedly to exit the **Original (Title)** menu.

Note

For discs formatted on a different DVD Recorder, you will see only a limited character set.

Making a New Playlist **VR**

Use this function to add an Original title or chapter to your Playlist (Program). When you do this, the whole title is added to the Playlist (you can erase parts you don't need later — see "Erasing an Original or Playlist Title/Chapter" on page 48).

The title appears in the Playlist complete with the chapter markers that appear in the Original. However, if you add more chapter markers to the Original later, these will not be automatically copied over into the Playlist title.

You can add up to 999 chapters to one disc. If you only want to add a chapter of a title, see "Adding Titles/Chapters to the Playlist" on page 48.

1 Press **DISC MENU/LIST** repeatedly to display **Original (Title)**.

If you want to display the Chapter menu, refer to "Using the Original (Chapter) menu" on page 45.

2 Choose an **Original title** or **chapter** to add to the **Playlist**, then press **ENTER**.

The **Original (Title or Chapter)** options appear on the left side of the **Original (Title or Chapter)** menu.

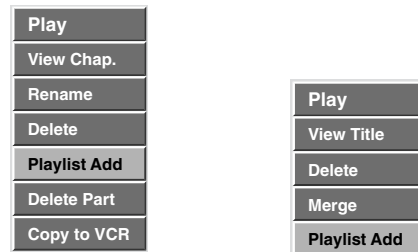

Original (Title)

Original (Chapter)

3 Use **▲ / ▼** to select 'Playlist Add' from the **Original (Title)** or **Original (Chapter)** options then press **ENTER**.

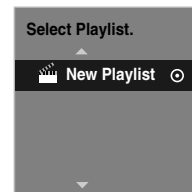

4 Select 'New Playlist' then press **ENTER**.

The new title appears in the updated Playlist. All chapters in the title are added to the Playlist.

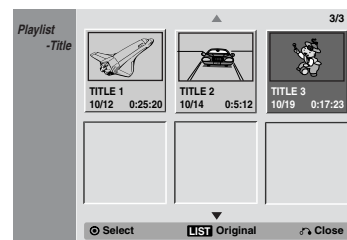

VR Mode: Original and Playlist Editing (Continued)

Erasing an Original or Playlist Title/Chapter **VR**

When you erase a title or chapter from the Playlist menu, you only remove it from the Playlist; the title/chapter remains in the Original menu.

If you choose to erase a title or chapter from the Original title/chapter list, the title or chapter is actually erased from the disc and the remaining time available for recording increases. Titles/chapters erased from the Original are also removed from the Playlist.

Note

It may not be possible to erase chapters that are less than 3 seconds long.

1 Press DISC MENU/LIST repeatedly to display Original (Title) or Playlist (Title).

If you want to display the Original (Chapter) or Playlist (Chapter) menu, refer to "Using the Original (Title) Menu" or "Using the Playlist (Title) Menu" on pages 45-46.

2 Use ▲▼◀▶ to choose a chapter or title you want to erase then press ENTER.

The Playlist or Original options appear on the left side of the screen.

3 Select 'Delete' on the menu.

e.g., If you select "Delete" on Original (Title) menu:

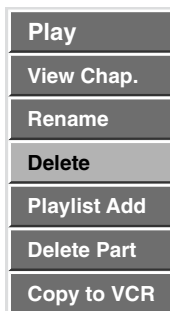

4 Press ENTER to confirm.

The confirm message for deleting will appear.

5 Use ◀/▶ to select 'Yes' then press ENTER.

The selected chapter or title is deleted. After pressing ENTER, the new, updated menu is displayed.

6 Repeat steps 2 - 5 to continue to delete from the menu.

7 Press RETURN (↵) repeatedly to exit the menu.

Adding Title/Chapters to the Playlist **VR**

You can add an Original title/chapter to a Playlist title even if it is already registered.

1 Press DISC MENU/LIST repeatedly to display the Original (Title) menu.

If you want to show the Original (Chapter) menu, refer to "Using the Original (Chapter) menu" on page 45.

2 Choose an Original title or chapter to put into the Playlist, then press ENTER.

The Original (Title) or Original (Chapter) options appear on the left side of the screen.

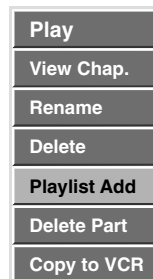

Original (Title)



Original (Chapter)

3 Use ▲ / ▼ to select 'Playlist Add' from the Original (Title) or Original (Chapter) options then press ENTER.

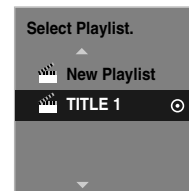

4 Choose the Playlist title that is already registered to insert a title, then press ENTER.

The title appears in the updated Playlist.

5 Repeat steps 1-4 to continue adding to the Playlist.

6 Press RETURN (↵) to exit, or DISC MENU/LIST to go back to the Original (Title) menu.

VR Mode: Original and Playlist Editing (Continued)

Combining Two Chapters Into One **VR**

Use this function to combine two adjacent Playlist or Original chapters into one.

1 Press **DISC MENU/LIST** repeatedly to display the **Original (Title)** or **Playlist (Title)** menu. If you want to display the **Original (Chapter)** or **Playlist (Chapter)** menu, refer to "Using the Original (Title) menu" and "Using the Playlist (Chapter)" on page 45-46.

2 First, select the second chapter of the two chapters you want to combine then press **ENTER**. The **Playlist (Chapter)** or **Original (Chapter)** options appear on the left side of the screen.



Original (Chapter)



Playlist (Chapter)

3 Use **▲ / ▼** to select 'Merge' then press **ENTER**. The confirm message for combining will appear.

4 Use **◀ / ▶** to select 'Yes' then press **ENTER**. After pressing **ENTER**, the new, updated menu is displayed.

5 Repeat steps 2 - 5 to continue to merge from the menu.

6 Press **RETURN** (↵) repeatedly to exit the menu.

Note

This function cannot operate listed below;

- If there is only one chapter within the title.
- If two chapters created by erasing a part from an original title.
- If two chapters created from different titles.
- If two chapters created by moving an order from an original title.

Moving a Playlist Chapter **VR**

Use this function to rearrange the playback order of Playlist chapters on the **Playlist (Title)** menu.

1 Press **DISC MENU/LIST** repeatedly to display **Playlist (Title)** menu.

To display the **Playlist (Chapter)** menu, refer to "Using the Playlist (Chapter)" on page 46.

Note

This function is not available if there is only one chapter.

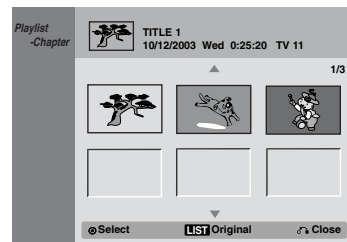

2 Select a chapter from the **Playlist (Chapter)** menu.

3 Press **ENTER**. The **Playlist (Chapter)** options appear on the left side of the screen.

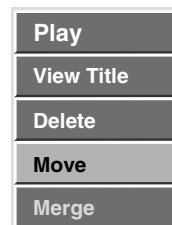

4 Use **▲ / ▼** to select 'Move' from the **Playlist** options then press **ENTER**.

5 Use **▲ ▼ ◀ ▶** to choose the place you want to move the chapter to then press **ENTER**. The confirm message for moving will appear.

6 Use **◀ / ▶** to select 'Yes' then press **ENTER**. After pressing **ENTER**, the new, updated menu is displayed.

7 Repeat steps 2 - 6 to continue to move from the menu.

8 Press **RETURN** (↵) repeatedly to exit the menu.

VR Mode: Original and Playlist Editing (Continued)

Deleting a Part **VR**

You can erase a part which you do not want in a title.

1 Press **DISC MENU/LIST** repeatedly to display the Original (Title) or Playlist (Title) menu.

2 Use **▲ ▼ ◀ ▶** to choose the title you want to delete then press **ENTER**.

The options appear on the left side of the menu.

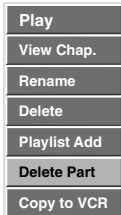

Original (Title)

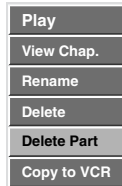

Playlist (Title)

3 Use **▲ / ▼** to select 'Delete Part' then press **ENTER**.

The Title Edit menu appears on the TV screen and the DVD Recorder+VCR goes into Pause mode.

The Start Point option is highlighted.

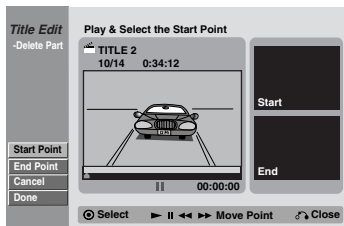

4 Use **PLAY, PAUSE/STEP, FF, REW,** and **Slow Motion playback** to find the starting point.

The segment is indicated in yellow on the Progress Bar.

5 Press **ENTER** at the starting point of the segment you want to erase.

The End Point option is selected.

6 Use **PLAY, PAUSE/STEP, FF, REW,** and **Slow Motion playback** to find the ending point.

7 Press **ENTER** at the ending point of the section you want to edit.

The Done option is selected.

To cancel the Edit mode, select **Cancel** using **▲ / ▼** then press **ENTER**.

8 Press **ENTER** to delete the selected part.

When the confirm menu appears, select "Yes" using **◀ / ▶** then press **ENTER**.

To erase additional segments, repeat steps 4-8.

9 When finished editing, press **RETURN** (↵).

The Original (Title) or Playlist (Title) menu appears.

Note

If you select **Cancel** then press **ENTER**, the DVD Recorder+VCR will go to former option and into Pause mode.

Video Mode: Original Editing

In this section, you will learn about editing DVD-R and DVD-RW discs in Video Mode.

Using the Title List Video

From the Title List display you can play, name and erase titles.

Once a Video mode disc is finalized, the Title List screen changes its appearance and all you can do is select titles to play.

1 Press DISC MENU/LIST to display the Title List.

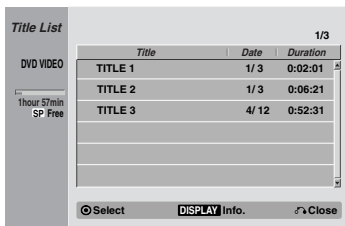

2 Use ▲ / ▼ to choose a title then press ENTER.

The Title List options appear on the left side of the Title List display.

For more information, press Display

3 Use ▲ / ▼ to select an option then press ENTER to confirm.



Play: Starts playback of the selected title.

Rename: Edits the title name; see page 47.

Delete: Deletes the title from the Title List.

Copy to VCR: Copies the title to a VHS tape.

4 Press RETURN (↵) repeatedly to exit Title List.

Erasing a Title Video

Before a disc is finalized, you can erase titles recorded on the disc.

⚠ Caution

- If you erase a title from a DVD-R disc, the title will disappear from the Title List, but the available recording time will not increase.
- When erasing a title from a DVD-RW disc, the remaining time available for recording will only increase if it is the last title on the disc.

1 Press DISC MENU/LIST to display the Title List.

2 Use ▲ ▼ ◀ ▶ to choose the title you want to erase then press ENTER.

The Title List options appear on the left side of the Title List screen.



3 Use ▲ / ▼ to select 'Delete' then press ENTER to confirm.

The confirm message for deleting will appear.

4 Use ◀ / ▶ to select 'Yes' then press ENTER.

The selected chapter or title is deleted.

After pressing ENTER, the new, updated menu is displayed.

5 Repeat steps 2 - 4 to continue to delete from the menu.

6 Press RETURN (↵) to exit the menu.

If the Disc Has Already Been Finalized

You will see a screen like the one shown below:

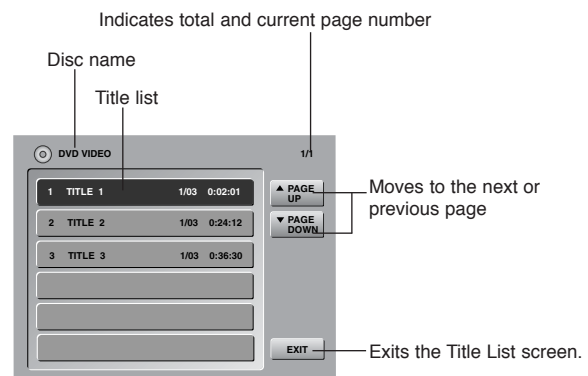

Programming the MultiBrand Remote to Control Your TV

You can program the DVD Recorder+VCR MultiBrand remote control to operate many TV brands and models.

- 1** In the chart below, find the code(s) corresponding to your brand of TV.
- 2** While holding down the TV POWER button, enter the 2-digit code number using the 0-9 buttons.
- 3** If your TV powers off or on, programming is complete. If not, repeat step 2 using the next code listed for your brand of TV.

Note

Due to the variety of codes used by manufacturers, our company cannot guarantee that the remote control will operate every model of the brands listed.

Buttons Used to Operate Your TV

Once the remote control is programmed, you can use the following buttons to control your TV:

- TV POWER
- TV INPUT
- CH ▼/▲
- VOL +/-
- MUTE

TV CODES BY BRAND

TV Brand Name	Codes	TV Brand Name	Codes
ADMIRAL	16,33,37,44,45	MONTGOMERY	01,06,08,09,
AIWA	70	WARD	23,24,32,33,34
AKAI	01	NEC	01,08
AMARK	09	NOBLEX	07
AOC	01	PACKARD BELL	43
BELL & HOWELL	33	PANASONIC	07,11,13,25,35,36
BROKSONIC	18,19	PHILCO	01,06,07,08,09,
CANDLE	51		15,38,43,58
CCE	07	PHILIPS	06,07,43,61,62,65
CENTURION	08	PIONEER	30
CINERAL	43	PORTLAND	09
CITIZEN	49,50,51,52,53,54,55	PROSCAN	03,37,44
CORONADO	09	QUASAR	11,13
CROWN	09	RADIO SHACK	16,17,23
CURTIS MATHES	01,03,08,33,35,37,44	RCA	01,03,37,44,69
DAEWOO	16,38,39,40,41,42,43	REALISTIC	16,17,23
DAYTRON	01,08	SAMPO	08
EMERSON	01,09,16,17,18,19	SAMSUNG	01,08,09,25,68
FISHER	28,29	SANYO	28,29
FUNAI	46,47	SCOTT	01,08
GENERAL ELECTRIC	03,10,11,13,37,44	SEARS	09,25,26,27,28,29
GRADIENTE	01,56,57,63,67	SEMP	64
HITACHI	09,14,15,43	SHARP	09,22,23,24,60,66
JC PENNEY	01,08,10,27,35	SIGNATURE 2000	01,06,08,09,10,
JVC	20,21,63,67		23,24,33,34
KIOTE	43	SONY	12,62
KMC	09	SOUNDESIGN	51
KTV	01,08,09,31	SYLVANIA	01,04,05,06,07,
LG (GOLDSTAR)	01,07,08,09,35,39,40		08,35,51
LODGENET	33	SYMPHONIC	46,47
LOGIK	33	TATUNG	11
LXI	09,24,25,26,27,28,29	TEKNIKA	07,09,16,33,51
MAGNAVOX	01,02,04,05,06,	TELERENT	09,33
	07,08,09,20,	THOMSON	69
	34,35,43,51,61,62,65	YORX	08
MAJESTIC	33	TOSHIBA	01,25,26,27,64
MARANTZ	01,32	WARDS	01,06,08,09,10,33,34
MEMOREX	33	XR1000	48
MGM/DAIICHI	01,08,32,34	ZENITH	02,33,59

Language Code List

Use this list to enter the appropriate code number for your preferred Disc Menu, Disc Audio, and Disc Subtitle languages; see page 20.

Code	Language	Code	Language	Code	Language	Code	Language
6566	Abkhazian	7074	Fiji	7678	Lingala	8373	Singhalese
6565	Afar	7073	Finnish	7684	Lithuanian	8375	Slovak
6570	Afrikaans	7082	French	7775	Macedonian	8376	Slovenian
8381	Albanian	7089	Frisian	7771	Malagasy	8379	Somali
6577	Amharic	7176	Galician	7783	Malay	6983	Spanish
6582	Arabic	7565	Georgian	7776	Malayalam	8385	Sudanese
7289	Armenian	6869	German	7784	Maltese	8387	Swahili
6583	Assamese	6976	Greek	7773	Maori	8386	Swedish
6588	Aymara	7576	Greenlandic	7782	Marathi	8476	Tagalog
6590	Azerbaijani	7178	Guarani	7779	Moldavian	8471	Tajik
6665	Bashkir	7185	Gujarati	7778	Mongolian	8465	Tamil
6985	Basque	7265	Hausa	7865	Nauru	8484	Tatar
6678	Bengali; Bangla	7387	Hebrew	7869	Nepali	8469	Telugu
6890	Bhutani	7273	Hindi	7879	Norwegian	8472	Thai
6672	Bihari	7285	Hungarian	7982	Oriya	6679	Tibetan
6682	Breton	7383	Icelandic	8065	Panjabi	8473	Tigrinya
6671	Bulgarian	7378	Indonesian	8083	Pashto, Pushto	8479	Tonga
7789	Burmese	7365	Interlingua	7065	Persian	8482	Turkish
6669	Byelorussian	7165	Irish	8076	Polish	8475	Turkmen
7577	Cambodian	7384	Italian	8084	Portuguese	8487	Twi
6765	Catalan	7465	Japanese	8185	Quechua	8575	Ukrainian
9072	Chinese	7487	Javanese	8277	Rhaeto-Romance	8582	Urdu
6779	Corsican	7578	Kannada	8279	Romanian	8590	Uzbek
7282	Croatian	7583	Kashmiri	8285	Russian	8673	Vietnamese
6783	Czech	7575	Kazakh	8377	Samoan	8679	Volapük
6865	Danish	7589	Kirghiz	8365	Sanskrit	6789	Welsh
7876	Dutch	7579	Korean	7168	Scots Gaelic	8779	Wolof
6978	English	7585	Kurdish	8382	Serbian	8872	Xhosa
6979	Esperanto	7679	Laothian	8372	Serbo-Croatian	7473	Yiddish
6984	Estonian	7665	Latin	8378	Shona	8979	Yoruba
7079	Faeroese	7686	Latvian, Lettish	8368	Sindhi	9085	Zulu

Country Code List

Use this list to enter the appropriate code number for the "Country Code" setting; see page 23.

Code	Country	Code	Country	Code	Country	Code	Country
AD	Andorra	ER	Eritrea	LC	Saint Lucia	SC	Seychelles
AE	United Arab Emirates	ES	Spain	LI	Liechtenstein	SD	Sudan
AF	Afghanistan	ET	Ethiopia	LK	Sri Lanka	SE	Sweden
AG	Antigua and Barbuda	FI	Finland	LR	Liberia	SG	Singapore
AI	Anguilla	FJ	Fiji	LS	Lesotho	SH	Saint Helena
AL	Albania	FK	Falkland Islands	LT	Lithuania	SI	Slovenia
AM	Armenia	FM	Micronesia	LU	Luxembourg	SJ	Svalbard and Jan Mayen Islands
AN	Netherlands Antilles	FO	Faroe Islands	LV	Latvia	SK	Slovak Republic
AO	Angola	FR	France	LY	Libya	SL	Sierra Leone
AQ	Antarctica	FX	France (European Territory)	MA	Morocco	SM	San Marino
AR	Argentina	GA	Gabon	MC	Monaco	SN	Senegal
AS	American Samoa	GB	Great Britain	MD	Moldavia	SO	Somalia
AT	Austria	GD	Grenada	MG	Madagascar	SR	Suriname
AU	Australia	GE	Georgia	MH	Marshall Islands	ST	Saint Tome and Principe
AW	Aruba	GF	French Guyana	MK	Macedonia	SU	Former USSR
AZ	Azerbaijan	GH	Ghana	ML	Mali	SV	El Salvador
BA	Bosnia-Herzegovina	GI	Gibraltar	MM	Myanmar	SY	Syria
BB	Barbados	GL	Greenland	MN	Mongolia	SZ	Swaziland
BD	Bangladesh	GM	Gambia	MO	Macau	TC	Turks and Caicos Islands
BE	Belgium	GN	Guinea	MP	Northern Mariana Islands	TD	Chad
BF	Burkina Faso	GP	Guadeloupe (French)	MQ	Martinique (French)	TF	French Southern Territories
BG	Bulgaria	GQ	Equatorial Guinea	MR	Mauritania	TG	Togo
BH	Bahrain	GR	Greece	MS	Montserrat	TH	Thailand
BI	Burundi	GS	S. Georgia & S. Sandwich Isls.	MT	Malta	TJ	Tadjikistan
BJ	Benin	GT	Guatemala	MU	Mauritius	TK	Tokelau
BM	Bermuda	GU	Guam (USA)	MV	Maldives	TM	Turkmenistan
BN	Brunei Darussalam	GW	Guinea Bissau	MW	Malawi	TN	Tunisia
BO	Bolivia	GY	Guyana	MX	Mexico	TO	Tonga
BR	Brazil	HK	Hong Kong	MY	Malaysia	TP	East Timor
BS	Bahamas	HM	Heard and McDonald Islands	MZ	Mozambique	TR	Turkey
BT	Bhutan	HN	Honduras	AN	Namibia	TT	Trinidad and Tobago
BV	Bouvet Island	HR	Croatia	NC	New Caledonia (French)	TV	Tuvalu
BW	Botswana	HT	Haiti	NE	Niger	TW	Taiwan
BY	Belarus	HU	Hungary	NF	Norfolk Island	TZ	Tanzania
BZ	Belize	ID	Indonesia	NG	Nigeria	UA	Ukraine
CA	Canada	IE	Ireland	NI	Nicaragua	UG	Uganda
CC	Cocos (Keeling) Islands	IL	Israel	NL	Netherlands	UK	United Kingdom
CD	Central African Republic	IN	India	NO	Norway	UM	USA Minor Outlying Islands
CG	Congo	IO	British Indian Ocean Territory	NP	Nepal	US	United States
CH	Switzerland	IQ	Iraq	NR	Nauru	UY	Uruguay
CI	Ivory Coast	IR	Iran	NU	Niue	UZ	Uzbekistan
CK	Cook Islands	IS	Iceland	NZ	New Zealand	VA	Vatican City State
CL	Chile	IT	Italy	OM	Oman	VC	Saint Vincent & Grenadines
CM	Cameroon	JM	Jamaica	PA	Panama	VE	Venezuela
CN	China	JO	Jordan	PE	Peru	VG	Virgin Islands (British)
CO	Colombia	JP	Japan	PF	Polynesia (French)	VI	Virgin Islands (USA)
CR	Costa Rica	KE	Kenya	PG	Papua New Guinea	VN	Vietnam
CS	Former Czechoslovakia	KG	Kyrgyzstan	PH	Philippines	VU	Vanuatu
CU	Cuba	KH	Kambodia6	PK	Pakistan	WF	Wallis and Futuna Islands
CV	Cape Verde	KI	Kiribati	PL	Poland	WS	Samoa
CX	Christmas Island	KM	Comoros	PM	Saint Pierre and Miquelon	YE	Yemen
CY	Cyprus	KN	Saint Kitts & Nevis Anguilla	PN	Pitcairn Island	YT	Mayotte
CZ	Czech Republic	KP	North Korea	PR	Puerto Rico	YU	Yugoslavia
DE	Germany	KR	South Korea	PT	Portugal	ZA	South Africa
DJ	Djibouti	KW	Kuwait	PW	Palau	ZM	Zambia
DK	Denmark	KY	Cayman Islands	PY	Paraguay	ZR	Zaire
DM	Dominica	KZ	Kazakhstan	QA	Qatar	ZW	Zimbabwe
DO	Dominican Republic	LA	Laos	RE	Reunion (French)		
DZ	Algeria	LB	Lebanon	RO	Romania		
EC	Ecuador			RU	Russian Federation		
EE	Estonia			RW	Rwanda		
EG	Egypt			SA	Saudi Arabia		
EH	Western Sahara			SB	Solomon Islands		

Troubleshooting

Check the following guide for the possible cause of a problem before contacting customer support.

Symptom	Cause	Solution
No power.	<ul style="list-style-type: none"> The power cord is disconnected. 	<ul style="list-style-type: none"> Plug the power cord into the wall outlet securely.
No picture.	<ul style="list-style-type: none"> The TV is not set to receive DVD Recorder+VCR signal output. 	<ul style="list-style-type: none"> Select the appropriate video input on the TV so the picture from the DVD Recorder+VCR appears on the TV screen.
	<ul style="list-style-type: none"> The video cable is not connected securely. 	<ul style="list-style-type: none"> Connect the video cable securely.
	<ul style="list-style-type: none"> The TV power is turned off. 	<ul style="list-style-type: none"> Turn on the TV.
No sound.	<ul style="list-style-type: none"> The equipment connected with the audio cable is not set to receive DVD Recorder+VCR signal output. 	<ul style="list-style-type: none"> Select the correct input mode on the audio receiver so you can listen to the sound from the DVD Recorder+VCR.
	<ul style="list-style-type: none"> The audio cables are not connected securely. 	<ul style="list-style-type: none"> Connect the audio cable securely.
	<ul style="list-style-type: none"> The power of the equipment connected with the audio cable is turned off. 	<ul style="list-style-type: none"> Turn on the equipment connected with the audio cable.
	<ul style="list-style-type: none"> The audio connecting cord is damaged. 	<ul style="list-style-type: none"> Replace it with a new one.
Playback picture is poor.	<ul style="list-style-type: none"> The disc is dirty. 	<ul style="list-style-type: none"> Clean the disc.
	<ul style="list-style-type: none"> Tape heads are dirty. 	<ul style="list-style-type: none"> Clean video heads.
	<ul style="list-style-type: none"> Tape is a rental or was recorded on another VCR. 	<ul style="list-style-type: none"> Use ▲/▼ for manual tracking adjustment while tape is playing.
DVD Recorder+VCR does not start playback.	<ul style="list-style-type: none"> No disc is inserted. 	<ul style="list-style-type: none"> Insert a disc or tape. (Check that the disc indicator on the front panel display is lit.)
	<ul style="list-style-type: none"> No tape is inserted. 	<ul style="list-style-type: none"> Insert a playable disc. (Check the disc type, color system, and regional code.)
	<ul style="list-style-type: none"> An unplayable disc is inserted. 	<ul style="list-style-type: none"> Insert a playable disc. (Check the disc type, color system, and regional code.)
	<ul style="list-style-type: none"> The disc is placed upside down. 	<ul style="list-style-type: none"> Place the disc with the playback side down.
	<ul style="list-style-type: none"> The disc is not placed within the guide. 	<ul style="list-style-type: none"> Place the disc on the disc tray correctly inside the guide.
	<ul style="list-style-type: none"> The disc is dirty. 	<ul style="list-style-type: none"> Clean the disc.
Picture from external input is distorted	<ul style="list-style-type: none"> The video signal from the external component is copy-protected. 	<ul style="list-style-type: none"> You cannot connect via the DVD Recorder+VCR. Connect the component directly to your TV.
	<ul style="list-style-type: none"> The skipped channels were deleted with the CH. Add/Del feature. 	<ul style="list-style-type: none"> Use the CH. Add/Del feature to restore channels. See "Channel Add/Delete" on page 18.
Some channels are skipped over when using CH (▲ / ▼)	<ul style="list-style-type: none"> Antenna or cables are loose. 	<ul style="list-style-type: none"> Tighten connections or replace cable.
	<ul style="list-style-type: none"> Wrong Tuning Band is selected in the DVD Recorder+VCR Setup menu. 	<ul style="list-style-type: none"> Try all "Tuning Band" options; see page 18 for details.
Camcorder image not shown.	<ul style="list-style-type: none"> Camcorder is off. 	<ul style="list-style-type: none"> Turn camcorder on and operate properly.
Camcorder image via A/V input or DV IN to DVD Recorder+VCR is not shown on TV screen.	<ul style="list-style-type: none"> DVD Recorder+VCR's source is not set to AV1, AV2 COMP, AV2 S-V, or DV IN. 	<ul style="list-style-type: none"> Use INPUT to select AV input channel (AV1, AV2 COMP, AV2 S-V or DV IN).
Can't play disc recorded on this DVD Recorder+VCR on another DVD player.	<ul style="list-style-type: none"> The disc was recorded in Video mode. 	<ul style="list-style-type: none"> Finalize the disc; see page 25.
	<ul style="list-style-type: none"> Some players will not play even a finalized disc recorded in Video mode. 	<ul style="list-style-type: none"> No solution.
	<ul style="list-style-type: none"> The disc was recorded in VR mode. 	<ul style="list-style-type: none"> The other player must be RW compatible in order to play it.
	<ul style="list-style-type: none"> Discs recorded with copy-once material cannot be played on other players. 	<ul style="list-style-type: none"> No solution.

Troubleshooting (Continued)

Symptom	Cause	Solution
Cannot record or did not record successfully.	• The remaining blank space on the disc is insufficient.	• Use another disc.
	• The source you are trying to record is copy-protected.	• You cannot record the source.
	• When setting the recording channel, the channel is tuned on the TV's own tuner.	• Select the channel on the DVD Recorder+VCR's built-in TV tuner.
	• When recording to a Video mode disc, programs that are copy-once protected cannot be recorded.	• Use a VR mode formatted disc for copy-once material.
Timer Recording not possible.	• Clock in DVD Recorder+VCR is not set to correct time.	• Set clock to correct time. See "Clock (Auto)" or "Clock (Manual)" on page 19.
	• Timer has been programmed incorrectly.	• Reprogram Timer. See "Timer Recording" on page 41.
	• TIMER indicator light does not appear after programming timer.	• Reprogram Timer.
Stereo Audio Record and/or Playback not present.	• TV is not Stereo-compatible.	• No solution.
	• Broadcast program is not in stereo format.	• No solution.
	• DVD Recorder+VCR A/V Out jacks are not connected to TV A/V In jacks.	• Make A/V connections. Stereo is available only via A/V output from DVD Recorder+VCR.
	• DVD Recorder+VCR Audio/Video Out is not selected for viewing at the TV.	• Select AUX or A/V source as TV input.
	• DVD Recorder+VCR's TV audio channel is set to SAP or MONO.	• Set TV audio channel mode to Stereo. See "Changing TV Audio Channel" on page 27.
Remote control does not work properly.	• The remote control is not pointed at the remote sensor of the DVD Recorder+VCR.	• Point the remote control at the remote sensor of the DVD Recorder+VCR.
	• The remote control is too far from the DVD Recorder+VCR.	• Operate the remote control within 23 ft (7 m).
	• There is an obstacle in the path of the remote control and the DVD Recorder+VCR.	• Remove the obstacle.
	• The batteries in the remote control are exhausted.	• Replace the batteries with new ones.

Moisture Condensation

Moisture condensation can occur:	In locations where moisture condensation may occur:
<ul style="list-style-type: none"> • When the DVD Recorder+VCR is moved from a cold place to a warm place. • Under extremely humid conditions. 	<ul style="list-style-type: none"> • Keep the DVD Recorder+VCR plugged into an AC power outlet with POWER On. This will help prevent condensation. • When condensation has occurred, wait a few hours for the DVD Recorder+VCR to dry before using it.

Reset the DVD Recorder+VCR

If you observe any of the following symptoms...

- The unit is plugged in, but the power will not turn on or off.
- The front panel display is not working.
- The DVD Recorder+VCR is not operating normally.

...you can reset the DVD Recorder+VCR as follows:

- Press and hold the POWER button for at least five seconds. This will force the unit to power off. Press the POWER button again to turn the unit back on.
- Unplug the power cord, wait at least five seconds, and then plug it in again.

Technical Specifications

General

Power requirements	AC 120V, 60 Hz
Power consumption	35W
Dimensions (approx.)	16.9 x 3.25 x 14.2 inches (430 X 83.5 X 360 mm) (w x h x d)
Mass (approx.)	14.9 lbs (6.8 kg)
Operating temperature	41°F to 95°F (5°C to 35°C)
Operating humidity	5% to 90%
Signal system	NTSC

Recording

Recording formats	DVD Video Recording, DVD-VIDEO
Recordable discs	DVD-ReRecordable, DVD-Recordable
Recordable time	DVD ; Approx. 1 hour (XP mode), 2 hours (SP mode), 4 hours (LP mode) VCR ; SP: 2 HOURS (T-120), SLP: 6 HOURS (T-120)/8 HOURS (T-160)
Video recording format	
Sampling frequency	27MHz
Compression format	MPEG 2
Audio recording format	
Sampling frequency	48kHz
Compression format	Dolby Digital

VCR Specifications

Head system	Four head helical scan azimuth system
Timer	12-hour display type with AM, PM
Tape speed	SP: 33.35 mm/sec, LP: 16.67 mm/sec, SLP: 11.12 mm/sec
Tape width	12.7 mm
Rewind time	About 65 seconds (T-120)
Antenna	75 ohms (VHF/UHF)
VHF output signal	Channel 3 or 4 (Switchable)
Channel coverage	VHF: 2-13, UHF: 14-69, CATV: 1-125 (4A, A-W, W+1 - W+84, A-5 - A-1)
Frequency range	20Hz to 20kHz
Signal-to-noise ratio	43dB
Dynamic range	88 dB
Channel separation	60 dB

DVD Specifications

Laser system	Semiconductor laser, wavelength 650 nm
Frequency response	DVD (PCM 48 kHz): 8 Hz to 22 kHz, CD: 8 Hz to 20 kHz
Signal-to-noise ratio	More than 95 dB
Harmonic distortion	Less than 0.008%
Dynamic range	More than 90 dB

Inputs

ANTENNA IN	Antenna or CATV input, 75 Ω
VIDEO IN	1.0 Vp-p 75 Ω, sync negative, RCA jack x 2
AUDIO IN	-6 dBm more than 47 kΩ, RCA jack (L, R) x 2
DV IN	4 pin (i.LINK/IEEE 1394 standard)

Technical Specifications (Continued)

Outputs

VIDEO OUT	1 Vp-p 75 Ω , sync negative, RCA jack x 1
S-VIDEO OUT	(Y) 1.0 V (p-p), 75 Ω , negative sync, Mini DIN 4-pin x 1 (C) 0.286 V (p-p) 75 Ω
COMPONENT VIDEO OUT (PROGRESSIVE SCAN)	(Y) 1.0 V (p-p), 75 Ω , negative sync, RCA jack x 1 (Pb)/(Pr) 0.7 V (p-p), 75 Ω , RCA jack x 2
Audio output (digital audio)	0.5 V (p-p), 75 Ω , RCA jack x 1
Audio output (optical audio)	Optical connector x 1
Audio output (analog audio)	1.1 Vrms (1 kHz, -6 dB), 600 Ω , RCA jack (L, R) x 2
RF OUT	Channel 3 or 4 (Switchable)

Accessories:

Video cable1	Audio cable1
RF 75 Ω Coaxial Cable1	Blank DVD-R disc2
Remote control1	Batteries2

- Design and specifications are subject to change without notice.

Manufactured under license from Dolby Laboratories. "Dolby", "Pro Logic" and the double-D symbol are trademarks of Dolby Laboratories.

DTS and DTS Digital Out are registered trademarks of Digital Theater Systems, Inc.

Limited Warranty

GoVideo DVD Recorder+VCR Limited Warranty

Who Provides the Limited Warranty

During the warranty period, the GoVideo Warranty Administrator will honor DVD Recorder+VCR service for 90 days labor, 1 year parts from the original date of consumer purchase. See below for Commercial, Industrial or Educational use coverage. The DVD Recorder+VCR remote control is warranted for 90 days from the date of purchase.



Who is Protected

This warranty protects the original consumer owner of this GoVideo product.

What is Covered and How Long

This warranty covers internal operating parts and service/labor to repair or replace covered parts in this GoVideo product for 90 days labor, 1 year parts, from the date of purchase, defined as follows: (1) Original Consumer Retail Purchase; (2) First Rental Purchase Agreement; or (3) First Lease Purchase Agreement (the "Warranty Period"). Labor and replacement parts supplied during the Warranty Period are covered only for the remaining portion of the original Warranty Period. The GoVideo Warranty Administrator shall have no liability for service under this warranty if non-OEM (Original Equipment Manufacturer) replacement parts are used in the repair of your GoVideo product.

What the Owner Must Do If Service is Required

If service under this warranty is required, log onto "www.govideo.com" to determine the nearest authorized GoVideo service center.

Other Warranty Coverage

Commercial, Industrial or Educational use has the same warranty coverage as stated in this warranty.

What are the Exceptions

This warranty does not cover: (1) Normal maintenance service, such as video head cleaning. (2) Damage from misuse, abuse, neglect or accident, natural disasters or Acts of God. (3) Cabinetry, decorative parts, A/C adapters, knobs or buttons. (4) The foreign country use of this product. (5) GoVideo product which has been electronically or mechanically modified in any way or incorporated into other products. (6) Installation and setup service adjustments. (7) Owner instruction. Your Owner's Guide provides information regarding operating instructions and user controls. For additional information, contact your authorized GoVideo dealer.

Go Video is not responsible for any shipping, handling or insurance charges.

This Exclusive Limited Warranty excludes all incidental and consequential damages. Some states do not allow the exclusion of incidental and consequential damages, so the above exclusion may not apply to you.

ALL IMPLIED WARRANTIES, INCLUDING IMPLIED WARRANTIES OF MERCHANTABILITY AND FITNESS FOR A PARTICULAR PURPOSE ARE LIMITED IN DURATION TO THE DURATION OF THIS WARRANTY PERIOD. Some states do not allow limitations on how long an implied warranty lasts, so the above limitation may not apply to you.

This Exclusive Limited Warranty gives you specific legal rights and you may also have other rights which vary from state to state.

GoVideo WARRANTY ADMINISTRATOR

7835 East McClain Drive • Scottsdale, Arizona 85260-1732

GO.VIDEO®

3834RV0002?

Printed in Korea

Free Manuals Download Website

<http://myh66.com>

<http://usermanuals.us>

<http://www.somanuals.com>

<http://www.4manuals.cc>

<http://www.manual-lib.com>

<http://www.404manual.com>

<http://www.luxmanual.com>

<http://aubethermostatmanual.com>

Golf course search by state

<http://golfingnear.com>

Email search by domain

<http://emailbydomain.com>

Auto manuals search

<http://auto.somanuals.com>

TV manuals search

<http://tv.somanuals.com>