

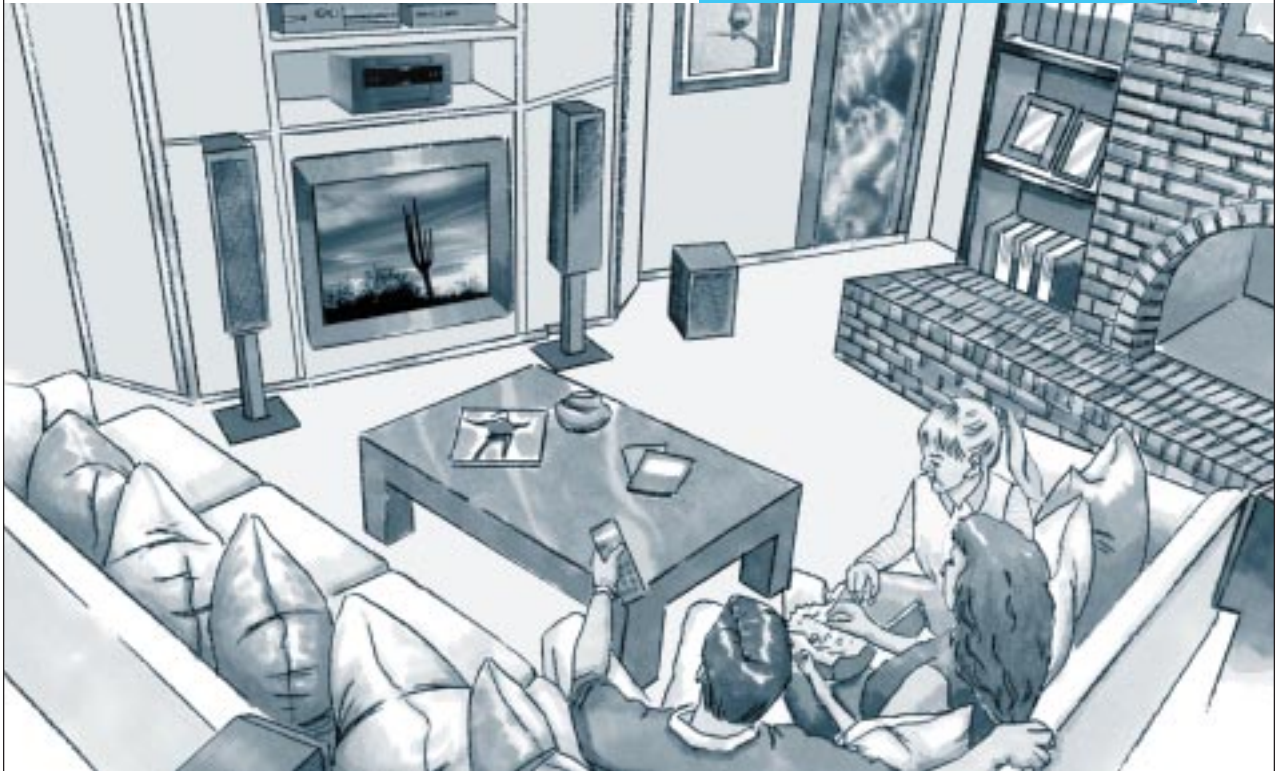

USER'S GUIDE



▶ Dual-Deck™ Video Cassette

*Featuring Space-Saving
Stacked Deck Design*

Recorder

▶
VHS-VHS
4-Head Hi-Fi to
4-Head Hi-Fi



Safety Instructions



1. **READ INSTRUCTIONS** - All the safety and operating instructions should be read before the unit is operated.
2. **RETAIN INSTRUCTIONS** - The safety and operating instructions should be retained for future reference.
3. **HEED WARNINGS** - All warnings on the unit and in the operating instructions should be adhered to.
4. **FOLLOW INSTRUCTIONS** - All operating and maintenance instructions should be followed.
5. **CLEANING** - Unplug this video unit from the wall outlet before cleaning. Do not use liquid or aerosol cleaners. Use a dry cloth for dusting cabinet.
6. **ATTACHMENTS** - Do not use attachments not recommended by the video product manufacturer, as they may be hazardous.
7. **WATER & MOISTURE** - Do not use this video unit near water — for example, near a bathtub, wash bowl, kitchen sink, laundry tub, in a wet basement, near a swimming pool or the like.
8. **ACCESSORIES** - Do not place this video unit on an unstable cart, stand, tripod, bracket or table. The video unit may fall, causing serious injury to a child or adult, and serious damage to the unit. Use only with a cart, stand, tripod, bracket or table recommended by the manufacturer or sold with the video unit. Any mounting of the unit should follow the manufacturer's instructions and should use a mounting accessory recommended by the manufacturer.
- 8a. An appliance and cart combination should be moved with care. Quick stops, excessive force, and uneven surfaces may cause the appliance and cart combination to overturn.
9. **VENTILATION** - Slots and openings in the cabinet are provided for ventilation to ensure reliable operation of the video unit and to protect it from overheating. These openings must not be blocked or covered. Never place your VCR on a bed, sofa, rug or other similar surface, on or near a radiator or heat register. This video unit should not be placed in a built-in installation such as a bookcase or rack unless proper ventilation is provided or the manufacturer's instructions have been adhered to.
10. **POWER SOURCES** - This video unit should be operated only from the type of power source indicated on the marking label. If you are not sure of the type of power supply to your home consult your appliance dealer or local power company. For video units intended to be operated from battery power, or other sources, refer to the operating instructions.
11. **GROUNDING OR POLARIZATION** - This video unit may be equipped with either a polarized 2-wire AC line plug (a plug having one blade wider than the other) or a 3-wire grounding plug having a third (grounding) pin.

The 2-wire polarized plug will fit into the power outlet only one way. This is a safety feature. If you are unable to insert the plug fully into the outlet try reversing the plug. If the plug still fails to fit, contact your electrician to replace your obsolete outlet. Do not defeat the safety purpose of the polarized plug.
12. **POWER-CORD PROTECTION** - Power-supply cords should be routed so that they are not likely to be walked on or pinched by items placed upon or against them, paying particular attention to cords of plugs, convenience receptacles, and the point where they exit from the unit.

PORTABLE CART WARNING

(Symbol provided by RETAC)



13. **OUTDOOR ANTENNA GROUNDING** - If an outside antenna or cable system is connected to the video unit, be sure the antenna or cable system is grounded to provide some protection against voltage surges and built-up static charges. Section 810 of the National Electrical Code, ANSI/NFPA No. 70-1984, provides information with respect to proper grounding of the mast and supporting structure, grounding of the lead-in wire to an antenna discharge unit, size of grounding conductors, location of antenna-discharge unit, connection to grounding electrodes, and requirements for the grounding electrode.

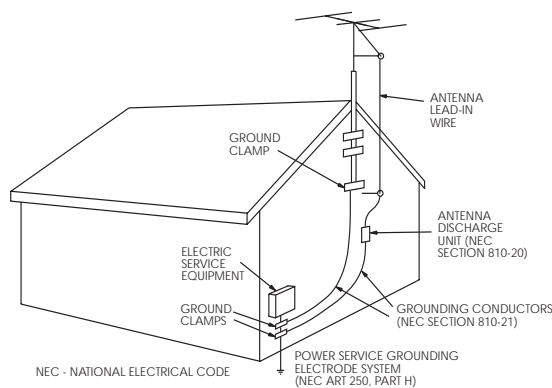

14. **LIGHTNING** - For added protection of this video unit during a lightning storm, or when it is left unattended and unused for long periods of time, unplug it from the wall outlet and disconnect the antenna or cable system. This will prevent damage to the video unit due to lightning and power line surges.
15. **POWER LINES** - An outside antenna system should not be located in the vicinity of overhead power lines or other electric light or power circuits, where it can fall into such power lines or circuits. When installing an outside antenna system extreme care should be taken to keep from touching such power lines or circuits as contact with them might be fatal.
16. **OVERLOADING** - Do not overload wall outlets and extension cords as this can result in the risk of fire or electric shock.
17. **OBJECTS AND LIQUIDS** - Never push objects of any kind into this video unit through openings as they may touch dangerous voltage points or short out parts that could result in a fire or electric shock. Never spill liquids of any kind onto the unit. Should spillage occur, unplug unit and have it checked by a technician before use.
18. **SERVICING** - Do not attempt to service this video unit yourself as opening or removing covers may expose you to a dangerous voltage or other hazards. Refer all servicing to qualified service personnel.
19. **DAMAGE REQUIRING SERVICE** - Unplug this video unit from the wall outlet and refer servicing to qualified service personnel under the following conditions:

- a. When the power supply cord or plug is damaged.
- b. If any liquid has been spilled onto or objects have fallen into the video unit.
- c. If the video unit has been exposed to rain or water.
- d. If the video unit does not operate normally by following the operating instructions. Adjust only those controls that are covered by the operating instructions. Improper adjustment of other controls may result in damage and will often require extensive work by a qualified technician to restore the video unit to its normal operation.
- e. If the video unit has been dropped or the cabinet has been damaged.
- f. When the video unit exhibits a distinct change in performance — this indicates a need for service.
20. **REPLACEMENT PARTS** - When replacement parts are required, be sure the service technician has used replacement parts specified by the manufacturer.
21. **SAFETY CHECK** - Upon completion of any service or repairs to this video unit, ask the service technician to perform safety checks to determine that the video unit is in proper operating condition.
22. **HEAT** - This video unit should be situated away from heat sources such as radiators, stoves, or other products (including amplifiers) that produce heat.

W A R N I N G

TO REDUCE THE RISK OF FIRE OR ELECTRIC SHOCK, DO NOT EXPOSE THIS APPLIANCE TO RAIN OR MOISTURE.

DO NOT OPEN THE CABINET; DANGEROUS HIGH VOLTAGE IS PRESENT. REFER SERVICING TO QUALIFIED PERSONNEL ONLY.

THIS VIDEO CASSETTE RECORDER SHOULD ONLY BE USED WITH 120V, 60Hz (STANDARD U.S. HOUSEHOLD) CURRENT.

FEDERAL LAW PROVIDES SEVERE CIVIL AND CRIMINAL PENALTIES FOR THE UNAUTHORIZED REPRODUCTION, DISTRIBUTION, OR EXHIBITION OF COPYRIGHTED MOTION PICTURES AND VIDEOTAPES. (TITLE 17, UNITED STATES CODE, SECTIONS 501 AND 506.)

USER/INSTALLER CAUTION:

Your authority to operate this FCC certified equipment could be voided if you make changes or modifications not expressly approved by the manufacturer, who is responsible for compliance with Part 15 FCC rules.

NOTE TO CATV SYSTEM INSTALLER:

This reminder is provided to call the CATV system installer's attention to Article 820-40 of the National Electronic Code that provides guidelines for proper grounding and, in particular, specifies that the cable ground shall be connected to the grounding system of the building, as close to the point of cable entry as practical.



Dual-Deck™ VCR

CONTENTS



- Introducing the Dual-Deck VCR
 - Discover the Dual-Deck Difference 1
 - Features of Your Dual-Deck VCR 3
- Chapter One
 - The Dual-Deck System 7
- Chapter Two
 - Operating Your Dual-Deck VCR 15
- Chapter Three
 - Programming Your Dual-Deck VCR 29
- Chapter Four
 - Connecting Your Dual-Deck VCR 43
 - Basic Connections 44
 - Basic Cable Connections 46
 - Cable Converter Box Connections 47
 - Monitor Connections 51
 - Connecting Other Video Equipment 52
- Appendix
 - A - Care of Your Dual-Deck VCR 55
 - B - Glossary 59
 - C - Help/Commonly Asked Questions 63
 - Troubleshooting Charts
 - No Menu is Visible 67
 - Poor Video Quality 68
 - Connecting VCR to TV, Monitor or Stereo ... 69
 - D - Customer Service Information 71
 - Authorized Go-Video Service/Repair Centers .. 71
 - Warranty Statement 72
 - E - Technical Specifications 73
- Index 75

Go-Video is a registered trademark of Go-Video, Inc. Copy Tape, AmeriChrome, Video Sequencing, and Dual-Deck VCR are trademarks of Go-Video, Inc. All other trademarks remain the property of their respective companies.

CAUTION:

To prevent fire, shock hazard, or annoying inter-ference, use only the recommended accessories.

To prevent electric shock, do not use this (polarized) plug with an extension cord, receptacle, or other outlet unless the blades can be fully inserted to prevent blade exposure.

To reduce the risk of electronic shock, do not remove the unit cover or back. There are no serviceable parts inside. Refer servicing to qualified personnel only.

CUIDADO:

Para prevenir incendio, riesgo de choque, o inter-ferencia enfadosa, use solamente los accesorios recomendados.

Para prevenir electrochoque, no use este enchufe (polarizado) con un cordón de extensión, toma de corriente, o cualquier otra toma a menos que los dientes puedan ser completamente insertados para prevenir exposición de los dientes.

Para reducir el riesgo de descarga eléctrica, no remueva la cubierta o la parte posterior del VCR. Dentro del VCR no hay partes que requieren servicio. Dirijase solamente a personal calificado cuando requiera servicio.

ATTENTION:

Pour éviter les incendis, risque de chocs, ou interférences fâcheuses, employer seulement les accessoires recommandés.

Pour éviter les chocs électriques, ne pas employer cette prise (polarisée) avec une rallonge, une prise de courant ou une autre sortie de courant à moins que les lames peuvent être insérées à fond pour l'exposition des lames.

Pour réduire les risques de chocs électriques, ne pas retirer le couvercle ou l'arrière du module. Il n'y a pas de pièce utilisable à l'intérieur. Ne faire effectuer l'entretien que par un personnel qualifié.

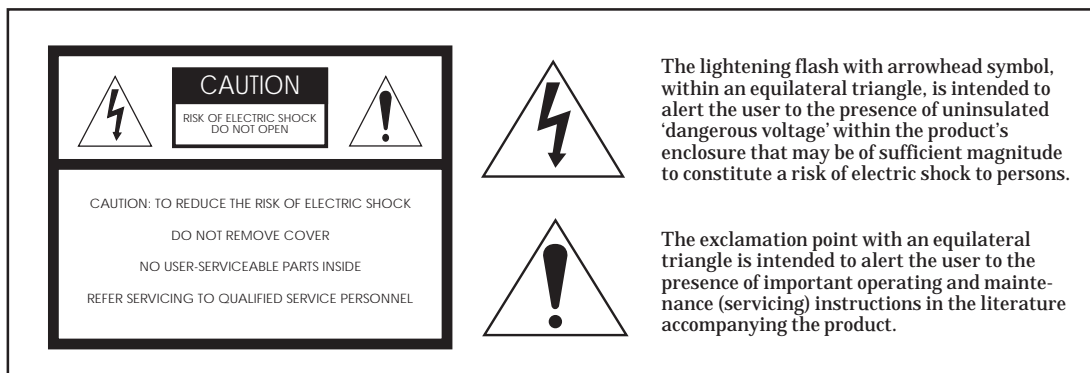



Discover the Dual-Deck™ Difference

INTRODUCTION



Make Picture Perfect Copies with Hi-Fi Audio of Any Video Tape at the Touch of a Button

Go-Video's Dual-Deck™ VCRs do things that even two VCRs wired together can't do. The secret behind this marvel of American electronics is Go-Video's patented AmeriChrome™ circuitry.

Enhanced AmeriChrome circuitry incorporates an advanced microcontroller that synchronizes deck speeds for optimum duplication results. Using Go-Video Dual-Deck VCRs, your video copies will be indistinguishable from the originals. No matter how many copies you make, each new tape will be crisp and clean.

Gone are the days of tangled clumsy cables between two VCR decks. Gone is the loss of picture quality from those intervening cables that degrade the signal. Gone is the flutter, roll and flashing of bad copies.

Go-Video Dual-Deck VCRs, with enhanced AmeriChrome circuitry, allow you to make clear, quality copies of any video tape for your own personal or home use at the touch of a button.

Dual-Deck Features

Feature:	Page:
Space Saving Stacked Deck Design	7
AmeriChrome Circuitry (HQ Copy), for Picture-Perfect Copies Generation after Generation	33
Built-in AV Switcher, to let you watch TV while making a copy of a video tape, or watch a tape while recording another	21, 22, 41
On-Screen Programming, in your choice of English or Spanish	36
4-Heads on both decks for high quality special effects	18, 19
Hi-Fi Stereo copies and playback	4, 37, 41
Audio Video Input/Output (AUX), for recording from other video equipment, laser disc players, camcorders, satellite receivers	32, 51-53
Edit video tapes easily with features such as Sync Edit, Syncro Start and Copy Audio Insert	26, 33
Use Skip Edit to quickly by-pass commercials with the Touch of a Button	27
Easy-to-Operate, Full Function VCR Remote	11
Sequential and Loop Record and Playback	20, 34-35
VHS Index Search System (VISS)/Automatic Show Finder (ASF)	28
MTS Stereo	37-38
Tuner 181 Channel	17
Remote Mute	11
Timer Recording (4 Events per Deck)	23, 40
Hi-Speed Rewind	8
Clock Backup Timer	5
One-Touch Record and OTR Loop	9, 22
Complete Program Record	25
Date/Time Stamp	26, 31
Remote Eject	12
Record Speed SP, EP	39
Auto Digital Tracking	20
Auto Head Cleaner	55-56
Digital Picture Enhancement Control	13, 18
Dual TV Outputs	31, 51



Features of Your Dual-Deck VCR



Make Quality Copies of Any Video at the Touch of a Button

The Dual-Deck VCR allows you to copy with just the press of the COPY button. Patented AmeriChrome circuitry maintains the high quality of your original recording.

Watch a Video Tape While You Record a TV Show

Why miss your favorite TV sit-com because the family wants to watch a rented video? With your Go-Video Dual-Deck VCR's special recording and playback functions you can record that TV show WHILE you watch a video tape.

Make Copies Directly from a Variety of Sources

You can make exceptional recordings from a variety of accessories, such as laser disc players, satellite receivers, camcorders, and other VCRs, using the front panel or rear panel audio and video inputs.

Never Again Miss the Last 5 Minutes of Your Favorite Mystery Video

The Dual-Deck's Complete Program Record feature automatically selects the recording speed for the best copy quality and time remaining on your tape or TV program. It will start recording in the high video image quality SP mode, but switch automatically to the EP mode if the programmed event is longer than the tape remaining.

Digitally Controlled Video Image Sharpness

Go-Video's digitally controlled Picture Enhancement feature gives you a greater depth of video image control, allowing you to sharpen or soften picture details for optimum performance.

Keep Track of Your Recordings with Date and Time Stamp

You can set the Dual-Deck VCR to record a date, time and record source message on the tape at the start of a timed or manual recording event.

Easily Locate Tape Segments with Automatic Show Finder (ASF)

Every time the Dual-Deck VCR enters record mode, an index mark is placed on the tape. Use the VHS Index Scan and Search System (VISS) to quickly locate these index marks during playback or while editing. Combined with the Time/Date Stamp feature, you can easily locate specific shows on a tape.

Eliminate Guesswork with Real Time Counter

The Dual-Deck VCR features a counter that indicates tape position in real time: hours, minutes, and seconds.

Make and Playback Hi-Fi Stereo Copies

You can connect your Dual-Deck VCR to your stereo system and hear your tapes and those TV programs that are broadcast with MTS Stereo Sound through your stereo speakers. Or, if you have a stereo TV with separate audio input jacks, you can connect the Dual-Deck VCR to your stereo and TV and enjoy stereo sound.

Record and Watch Your Favorite Video at Your Convenience

The Timer Record Menu makes it easy to set the date and time for the TV program you wish to record. You can easily select different channel sources and speeds for each timer event independently. The Dual-Deck VCR automatically double checks your request and reports errors that may prevent your selected program from recording, and will record a timed event regardless of whether the power is on or off.

Record and Play Back Tapes without Interruption with Video Sequencing

Exclusive Video Sequencing allows you to play or record using both decks, in sequence, without interruption. This uninterrupted playback feature also allows you to continually switch back and forth from one tape to another.

Your Dual-Deck VCR supports both loop and sequential modes. Loop mode allows you to start a tape in either deck and when it finishes, a tape in the other deck automatically starts. When that tape finishes, any tape in the first deck will start and so on. Sequential mode allows you to start a tape in Deck One and when it finishes, a tape in Deck Two will automatically start.

Eliminate Tracking Noise Automatically with Digital Tracking

Your Dual-Deck VCR's Enhanced Automatic Tracking feature quickly eliminates video noise (white streaks) automatically.

Dual Video Outputs

Watch a show on one TV and a video tape on another.

Dual, independently controlled, audio and video outputs allow you to connect two monitors to your Dual-Deck VCR. This feature allows you to watch a show on one monitor and a video tape on another or set up a home 'editing suite' to monitor both Deck One and Deck Two simultaneously.

Automatic Features

Auto Play/Rewind • When a tape with no record safety tab is inserted into either deck, your Dual-Deck VCR begins playing the tape. When that tape has finished playing, it will automatically rewind. You can turn these features on or off in the Features menu.

Auto Power Off • While rewinding a tape, timer recording, one-touch recording, copying a tape, or using EZ-Copy, press the POWER button and your Dual-Deck VCR will automatically turn off when that function is completed. The Power indicator will blink while this mode is active. If you press the Power button while it is blinking, you will cancel Auto Power Off.

Auto Power On • Power turns on when a tape is inserted into either deck. The TV/VCR indicator switches to VCR.

Auto Stop • Your Dual-Deck VCR will stop if a deck is left in Record Pause for more than 5 minutes, and will begin playing again if left in Play Still for more than 5 minutes. This prevents excessive wear on the tape.

Remote Eject • You can eject tapes using your Remote Control. Press STOP/EJECT to eject a tape which is stopped.

Fail-Safe Timer • Your Dual Deck VCR contains Enhanced AmeriChrome circuitry which prevents errors while programming the timer. If a potential problem is detected in a timer event, the Dual-Deck VCR warns you with an On-Screen Display message that is easy to understand.



The Dual-Deck System

CHAPTER

1

Front Panel Buttons and Indicators

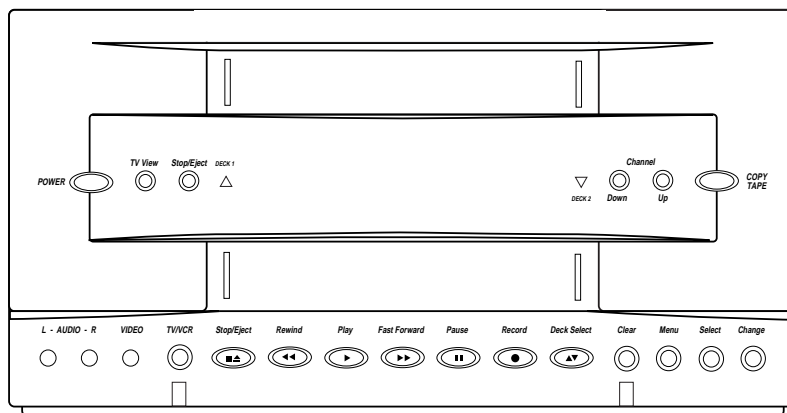

Dual-Deck VCR Package Contents:

- Dual-Deck VCR
- Full Function VCR Remote
- 2 AA Batteries
- One RF Cable
- User's Guide
- Quick Reference Guide
- Warranty Registration Card

The Dual-Deck VCR has 18 keys on the front panel.
They are:

- POWER** Press to turn your VCR on and off or to set the Auto Power OFF mode.
- TV/VCR** Press to switch control of the picture between the TV and the VCR. This is the antenna switch. When set to TV, the antenna signal goes directly to the TV; when set to VCR, the antenna signal goes through the VCR (your TV must be tuned to channel 3 or 4).
- CH UP** Press (+) to increase channel numbers, to go to the next higher channel stored in channel memory.
- CH DN** Press (-) to decrease channel numbers, to go to the next higher channel stored in channel memory.

 Press to copy from Deck One to Deck Two.

 Press to select which deck is controlled by the keys to the left. When Deck One is active, the green indicator will be on; when Deck Two is active, the red indicator will be on.

 Press to play the tape in the active deck. Press for 1.5 seconds during play to execute ATR (auto tracking).

 REWIND - Press to rewind the tape in the active deck. Press while tape is playing to rewind while viewing the picture (reverse picture search or Review 1). Press the rewind key again to Reverse Accelerated Search or Review 2. Press REW during playback to move between Review 1 and Review 2.

 FAST FORWARD - Press to fast forward the tape in the active deck. Press while a tape is playing to fast forward while viewing the picture (forward picture search or Cue 1). Pressing the Fast Forward key again will put the deck in to Forward Accelerated Search or Cue 2. Press FFWD during playback to move between Cue 1 and Cue 2.

 STOP/EJECT - Press to stop the tape in the active deck. Press again to eject a stopped tape.

NOTE:
Both decks record!

 RECORD - Press to start recording onto a tape in the active Deck. Press to continue recording after a Pause. Press during recording to activate One-Touch Recording, or Loop Recording.

 PAUSE/STILL - Press to temporarily stop a tape while playing (still) or recording (pause). If you leave Pause on for 5 minutes, the VCR will automatically resume playback to prevent tape damage.

NOTE:
An asterisk in a box - , will appear on the screen to the left of the currently selected TV view.

 TV VIEW - Press to select which source you will view on your TV - Deck One, Deck Two, Tuner (TV channel), or Aux input. The TV/VCR button must be set to VCR for you to see these sources.

 CLEAR - Press to clear programming entries such as in Timer Recording menu. Also press to reset the counter of the selected deck to zero.

 MENU - Press to enter and exit the On-Screen menu System.

 SELECT (MUTE button) - Press to move up and down the items on the menu screen when in On-Screen Programming. When not in On-Screen Programming, press to turn off the audio (sound). Press again to turn the audio back on.

CHANGE CHANGE (LCV) - Press to cycle through selections of the menu item selected when in On-Screen Programming. When not in On-Screen Programming, press to return to the 'Last Channel Viewed'.

Front Panel Display

The Front Panel Display tells you what is happening as you use your Dual-Deck VCR. This Front Panel Display will show the following: STOP, PLAY, EJECT, REC, REW, FF, REVIEW, CUE, ON, OFF, LOOP, SLOW, PAUSE, STILL, END, PIC, 1-2.

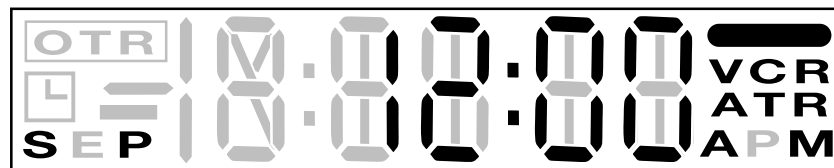

The Front Panel Display also has several indicators/icons. Each indicator on the Front Panel Display shows the status of one of the VCR's functions.

Timer • If you have programmed the VCR to record a TV show at a certain time (Timer Record), the Timer indicator will be ON. It will also be on while the VCR is recording a program. It will blink if there is a timer error.

Record Indicator • This indicator will be on during Record, OTR and Timer Record.

Power Indicator • This indicator will blink when VCR is in the auto power off mode.

VCR Indicator • This indicator will be ON when the VCR is in VCR mode and off when the VCR is in TV mode. Use the TV/VCR key on your remote to select the mode.

COUNTER/CLOCK • This display shows the clock time while viewing Tuner or Aux. The clock time displays in hours and minutes, with AM and PM indicated. Counter is shown while viewing Deck One or Deck Two. Pressing the CTR/CLK key on the remote switches this display between the clock and the counter.

OTR Indicator • One-Touch Recording. This indicator will be on during One-Touch Recording. The display will also show the amount of time programmed for recording. Each time you press the REC key after the first time, you get 30 minutes of record time (i.e., pressing REC 3 times will result in 60 minutes of record time).

AM/PM • This indicator tells whether the time is AM or PM.

SEP • This indicator shows the tape speed for each deck. If you are playing a tape, the tape speed is the speed at which the tape was recorded. Tapes can be played in three speeds, SP, EP and LP. Tapes can be recorded in SP and EP.

ATR • Auto Tracking. This indicator will be blinking during automatic tracking. It will be on during play-back unless tracking is adjusted manually.

Remote Control

Before you begin, be sure to put the two supplied AA batteries in the remote.

Your remote control makes it simple to operate and program your Dual-Deck VCR. Take a moment to learn where the buttons are located on the remote control.

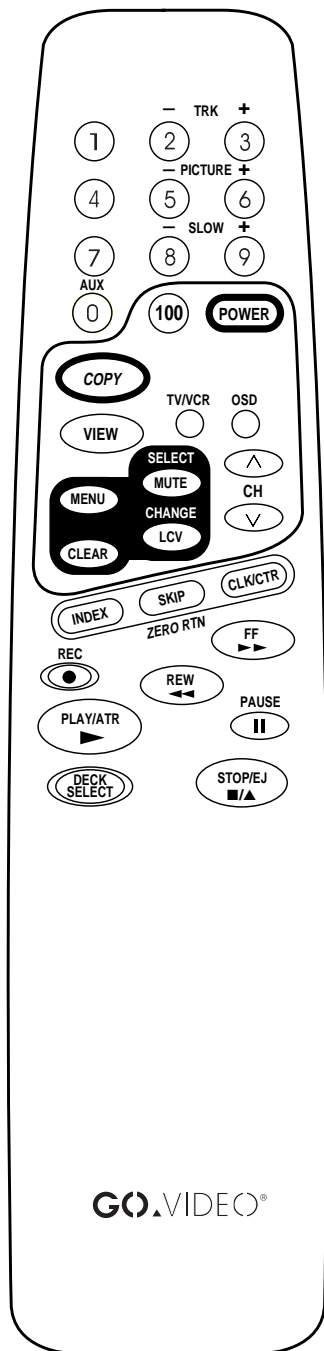

NOTE:

Some buttons have a dual function.
The alternative function is
listed above the button.

POWER Press to turn your Dual-Deck VCR on and off or to set the Auto Power OFF mode.

COPY Press to copy tapes from Deck One to Deck Two.

PLAY/ATR Press to play a tape in the active deck. If you have manually adjusted tracking using the TRACKING keys, press this key for 1.5 seconds to reactivate Automatic Tracking.

INDEX Press to begin an Index Scan or an Index Search. Enter two numeric digits and then press the Fast Forward or Rewind key to initiate the search. In search, the VCR counts to the desired mark and begins play. This can be done either when the deck is playing or is stopped. Press FF or REW without entering digits to initiate a scan. In scan, the VCR stops at each index mark, plays 5 seconds, and moves on. Press while recording to place an Index Mark on the tape. An Index Mark is also automatically placed on a tape every time you begin recording from stop.

LCV Last Channel Viewed. If you have a certain channel you want to come back to easily, enter it using the numerical keys. Then you can flip through other channels using the up and down channel keys and easily return to this channel by pressing the LCV button. This is also the Change button.

SELECT Press to move up and down the items on the menu screen when in On-Screen Programming. This key is also used to move you to the next selection in the Set Date/Time and Timer Record menus. This is also the Mute button.

TV/VCR Press to switch the antenna connection between your VCR and your TV. When in VCR mode, VCR will appear on the Front Panel Display. TV mode is the same as if your VCR were turned off.

MUTE Press to turn off the audio (sound). Press again to turn the audio back on. This will not affect recording. This is also the Select button.

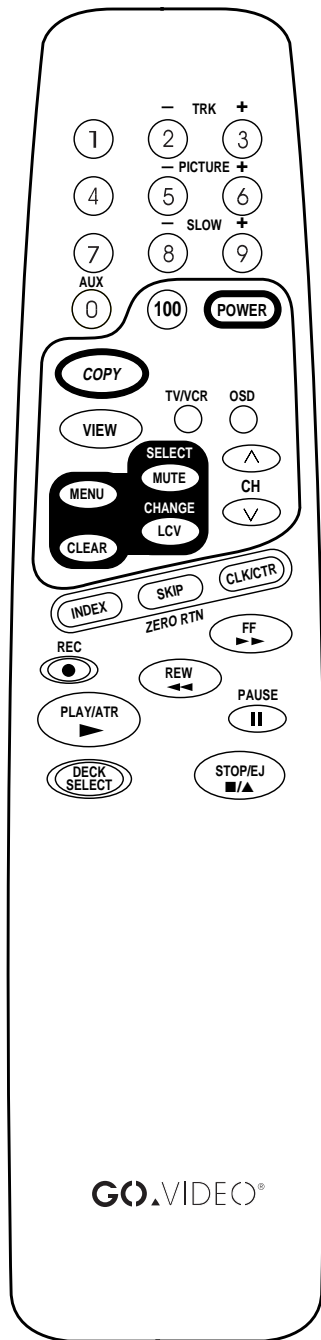

- CHANGE** Use this key to cycle through the choices of the menu item you selected. This is also the LCV (Last Channel Viewed) button.
- 100** Press to enter a cable channel number between 100 and 125. For example, select cable channel 123 by pressing 100 + 2 + 3. Set Cable channel 100 by pressing 100 + 0 + 0.
- CLEAR** Allows you to clear programming such as entries in the Timer Recording menu. It also resets the counter of the selected deck to zero.
- ZERO RETURN** If you want, you can have the tape automatically stop at the zero point on the Tape Counter. To do this, press Zero Return during stop and the VCR will automatically Fast Forward or Rewind to counter position 0:00:00. This is also the Skip button.
- OSD** Press to manually summon the On-Screen Display. Press again to turn the On-Screen Display off. Press again to summon the display with date.
- CLK/CTR** Repeatedly pressing this button changes the Front Panel Display between the clock and the counter when viewing Deck One or Deck Two.
- CH** Use the Channel keys (CH Up and Down) to change to the next higher and next lower channel. These keys will only stop at the channels you have programmed into Channel Memory in the Tuner Setup menu.
- DECK SELECT** Press to select which deck is active. When Deck One is active, the green indicator will be on; when Deck Two is active the red indicator will be on.
- REW** Press while the active deck is stopped to rewind the tape. Press while a tape is playing to rewind while viewing the picture (Review 1). Press again to speed up picture rewind (Review 2). Push Play to return to playback mode.
- STOP/EJ** Press to stop the tape in the active deck. Press again to eject a stopped tape.
- FF** Press while the active deck is stopped to fast forward the tape. Press while a tape is playing to fast forward while viewing the picture (Cue 1). Press again to speed up picture scan (Cue 2). Push Play to return to playback mode.
- REC** Press to start recording onto a tape in the active Deck. Press while tape is paused to resume recording. Press while recording to activate One-Touch Recording. Press while in Play Still to move to Record Pause.

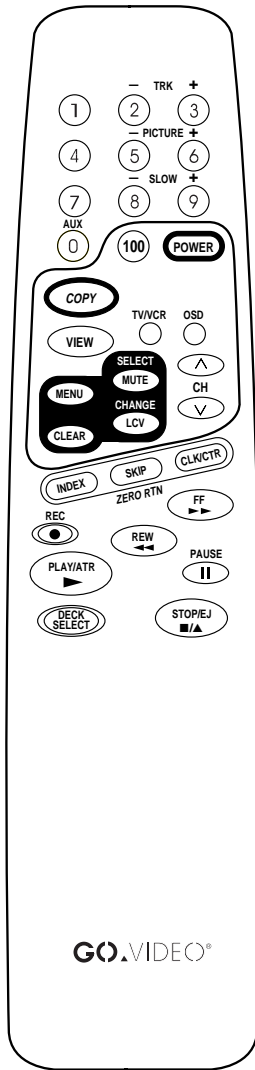

NOTE:

'00' = AUX (see page 22).

PAUSE

Press to temporarily stop a tape while recording (pause) or while playing (still). Push while in Still to Frame Advance.

SLOW+

Pressing these buttons slows the speed the tape is playing. Successive pressings of the + key on the remote steps up the speed of the tape. Successive pressings of the - key on the remote slows down the speed of the tape. Press PLAY to resume normal speed. These are also the ⑤ and ⑥ buttons.

SKIP

During playback, pressing this key once causes the tape to forward picture search for 60 seconds. Pressing it twice causes the picture to forward picture search for 120 seconds. Press up to 5 times to skip 5 minutes. This is also the Zero Return button.

During Copy, pressing this key once will edit out the next 60 seconds of your copy tape. Press twice to easily remove commercials when copying TV shows. Press up to 5 times to edit out 5 minutes.

TRK+

Press to manually adjust the tracking while playing a tape. These are also the ② and ③ buttons.

TRK-

MENU

Press to enter and exit the On-Screen menu System.

PICTURE +

Digital Picture Enhancement. Press to adjust picture sharpness. You can press this button 8 times, up or down to adjust sharpness. These are also the ⑤ and ⑥ buttons.

PICTURE -

VIEW

Press to select which source you will view on your TV - Deck One, Deck Two, Tuner (TV channel), or Line input. The TV/VCR button must be set to VCR for this button to work.

0-9

Press two digits to enter a desired channel. Press '0' first for channels 1-9. Also used for menu system programming.

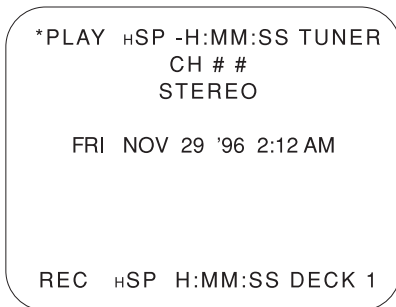

NOTE:

An asterisk in a box - , will appear on the screen to the left of the currently selected TV view.

On-Screen Display

The On-Screen Display contains information about the status of each deck. The On-Screen Display appears on your screen automatically when you turn the power on, when you press a deck function key (such as Play, Rewind, etc.) and when you change channels. The On-Screen Display also shows any Timer Record errors and status.

This automatic display will disappear after a few seconds. You can also manually summon the on-screen display by pressing the OSD key on the remote control. If you do this, the On-Screen Display will remain on the screen until you press OSD again.

If you don't want the On-Screen Display to come on automatically, you can set the DISPLAY MODE in the SETUP MENU to OFF.

The On-Screen Display has three basic parts:

Date/Time This indicator displays the current date and time.

Deck Status Displays the tape status (such as Play, tape speed, Rewind, etc.), current tape counter time, and record source. OTR and the duration will be displayed if One-Touch Recording is in progress.

CH The channel indicator displays the channel that the Dual-Deck VCR is tuned to.

In addition, the tuned channel's audio mode (Mono, Stereo, SAP or TV/SAP) is displayed below the CH indicator.

H A small 'H' will appear next to the Tape Speed to indicate when a tape with Hi-Fi Audio is being recorded or played.



Operating Your Dual-Deck VCR

CHAPTER 2

NOTE:

You may program your menus to be in Spanish. See the Set Clock/Language menu. See page 30.

NOTE:

The first time you press **MENU** after hooking up your VCR or after a power failure, the SET LANGUAGE screen will automatically come up. At that time, choose your language preference (1 or 2) and press **MENU** to proceed with step 3. Until you set the date and time, pressing menu will display SET CLOCK/LANGUAGE menu, then the FEATURES menu, and the DECK TWO menu and DECK ONE menu.

FEATURES MENU
1 * SETUP MENU
2: COPY MODE HQ1
3: SPEED MATCHING ON
4: COPY AUDIO INSERT OFF
5: EZ-COPY OFF
6: PLAYBACK MODE NORM
7: RECORD MODE NORM
PRESS SELECT/CHANGE TO SET AND MENU WHEN DONE

SETUP MENU
1: SET CLOCK/LANGUAGE
2: TUNER SETUP MENU
3: AUTO PLAY/REWIND BOTH
4: ON-SCREEN DISPLAY AUTO
5 * DATE/TIME STAMP ON
6: SECOND TV VIEW AUTO
7: AUX INPUT FRONT
PRESS SELECT/CHANGE TO SET AND MENU WHEN DONE

Setting the Date and Time

If you plan to use the Timer Record or Date and Time Stamp features of your Dual-Deck VCR, you'll need to set the correct date and time first.

To set the current date & time:

1. Press **MENU**. The Features menu will appear.
Note: If you press **MENU** and do not get the Features menu, continue pressing **MENU** until you see the Features menu.
2. Press **1**. The Setup menu will appear.
3. Press **1**. The Set Clock/Language menu will appear.
4. Press **1**. The Set Time and Date screen will appear.
5. Follow the blinking prompt on the screen to set the date and time. Use the numerical keys to enter information. As you enter each item of information, the prompt will automatically go to the next item.

If you don't need to change the information for a particular item, press **SELECT** (Mute button) to move to the next item.

You will enter the following items of information:

Hour • Enter only the hour. For example, if the time is 4:28, enter 0 4.

Minute • Enter only the minute. For example, if the time is 4:28, enter 2 8.

AM or PM • Enter 1 for AM or 2 for PM.

Month • January is 01, October is 10, etc.

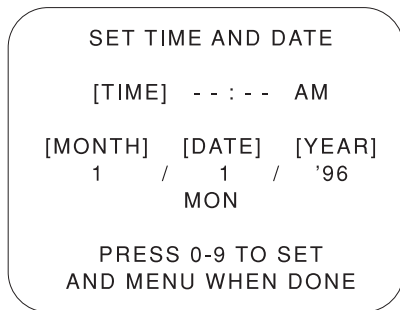

Date • Enter the day of the month. For example, if today is the fourth, enter 0 4.

Year • Enter only the last two digits. For example, 9 6 for 1996.

6. If you need to go back and change anything, press (Mute button) repeatedly until you get to that item.
7. When you have set the time and date, press to save the information and return to the CLOCK/LANGUAGE menu.
8. Press until you exit the menu system.

Setting Antenna & Channel Memory

Once you have your Dual-Deck VCR hooked up to your antenna or directly to a cable system without a cable converter box, you'll need to set the antenna and the channel memory. If you are using a cable converter box, you will need to set your VCR's tuner channel to receive only the cable converter box output channel.

Your Dual-Deck VCR comes with a 181 channel MTS tuner capable of receiving both over-the-air and cable broadcasts in stereo. Reception for channels 2-13 are the same on regular broadcast or on cable TV. But above channel 13, cable TV (CATV) reception is different from broadcast TV.

FEATURES MENU
1 * SETUP MENU
2: COPY MODE HQ1
3: SPEED MATCHING ON
4: COPY AUDIO INSERT OFF
5: EZ-COPY OFF
6: PLAYBACK MODE NORM
7: RECORD MODE NORM
PRESS SELECT/CHANGE TO SET AND MENU WHEN DONE

SETUP MENU
1: SET CLOCK/LANGUAGE
2: TUNER SETUP MENU
3: AUTO PLAY/REWIND BOTH
4: ON-SCREEN DISPLAY AUTO
5 * DATE/TIME STAMP ON
6: SECOND TV VIEW AUTO
7: AUX INPUT FRONT
PRESS SELECT/CHANGE TO SET AND MENU WHEN DONE

TUNER SETUP MENU
CH : #
SAP IS AVAILABLE
* ANTENNA SOURCE TV
AUTO PROGRAM
ADD CHANNEL
DELETE CHANNEL
TUNER AUDIO STEREO
PRESS SELECT/CHANGE TO SET AND MENU WHEN DONE

NOTE:

In cases of poor or weak video reception, your Tuner Setup menu may not be visible. When this happens, select a strong local channel where the menu will be visible again.

1. Press **MENU** on your remote control. The Features menu will appear.
2. Press **1**. The Setup menu will appear.
3. Press **2**. The Tuner Setup menu will appear.
4. Set the ANTENNA SOURCE. Press **CHANGE** to cycle between TV and CATV (cable). When the desired option is on the screen, go to step 5.
5. Press **SELECT** (Mute button) to move to AUTO PROGRAM.
6. Press **CHANGE** (LCV button) to begin automatic channel programming. The VCR will go through all possible TV or cable channels, and will automatically put the channels which you receive into Channel Memory. This will take a few minutes to complete.
7. If you wish, you can program certain channels into Channel Memory or remove them from Channel Memory manually. You can also select stereo sound. To do this, see the TUNER SETUP menu section of this manual. See page 35.
8. Press **MENU** to save the changes and to exit to the SETUP menu.
9. Press **MENU** until you exit the menu system.

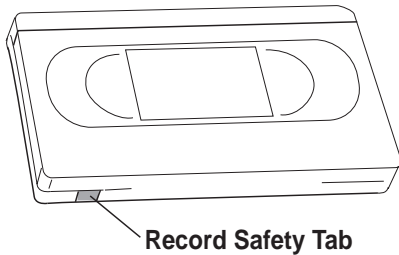

Playing a Tape

Playing a tape on your Dual-Deck VCR is simple:

1. Insert a tape into either deck of your VCR. If the tape is a play- only tape (it has no record safety tab) and AUTO PLAY/REWIND in the SETUP menu is set to PLAY or BOTH, it will automatically begin to play when inserted. Control will automatically switch to that deck; you don't need to do it manually. Also, when the tape is finished playing, it will automatically rewind if AUTO/PLAY REWIND in the SETUP menu is set to REWIND or BOTH.

Note: *If you have set the AUTO PLAY/REWIND item in the SETUP menu to OFF or REW, press [PLAY] to begin playing the tape; if you have the item set to OFF or PLAY, press [REW] to rewind the tape.*

2. Press [STOP] to stop the playback altogether.

NOTE:

Your remote control has one set of keys to control both decks. If you have difficulty operating a deck, check to be sure the Deck Select is set to the deck you want to operate. The red LED indicates Deck Two is selected; the green LED indicates Deck One is selected.

Special Playback Functions

With your Dual-Deck VCR, the playback function is not limited to simply playing tapes:

- Watch a tape while recording another tape — you can record a program on Deck Two and watch a tape play on Deck One simply by starting the recording as you normally would in Deck Two, and then play a tape in Deck One.
- You can pause the tape for a stop action picture (*Play Still*), or play a tape in slow motion or search a tape frame-by-frame (*Frame Advance*).* (See 'PAUSE' page 13.) The audio will mute during these functions.
- You can adjust tracking automatically or manually; you can also adjust playback picture sharpness.
- You can play Deck One and Deck Two in automatic sequence (*Sequential Play*) and even play one deck and then the other, back and forth in automatic rotation (*Loop Play*).

While you are playing a tape, you can use the remote control or front panel keys to perform the following functions:

- When you are using any special playback function, press **PLAY** to resume normal playback, or **STOP** to stop the tape. You can also Pause, Rewind, Fast-Forward, and Slow down the playback by pressing the appropriate keys.
- Press **PAUSE** to enter Play Still mode. The picture will freeze on the screen. PAUSE/STILL will appear on the Front Panel Display. While in Play Still mode, you can press **PAUSE** again to advance the picture one frame. If the deck remains in Play Still for 5 minutes, it will automatically begin to play again to prevent possible damage.
- Press **SLOW-** or **SLOW+** to enter Slow Motion playback. The tape will play at slow speed. SLOW will appear on the Front Panel Display. While in Slow Motion playback, each time you press **SLOW-** play slows down a little and each time you press **SLOW+**, play speeds up a little. These are also the **8** and **9** buttons.
- Press **FF** to enter Forward Picture Search (CUE 1). The tape will run at high speed and you will be able to see the picture. CUE will appear on the Front Panel Display.
- Press **FF** again to enter Jet Search (CUE 2). The tape will run at extra high speed and you will be able to see the picture. You will see CUE blinking on the Front Panel Display. Press **PLAY** to resume playback.
- Press **REW** to enter Reverse Picture Search (REVIEW 1). The tape will run in reverse at high speed and you will be able to see the picture. REVIEW will appear on the Front Panel Display.
- Press **REW** again to enter Reverse Jet Search (REVIEW 2). The tape will run in reverse at extra high speed and you will be able to see the picture. REVIEW will blink on the Front Panel Display. Press **PLAY** to resume playback.

Sequential and Loop Play

With *sequential play*, your Dual-Deck VCR will play a tape in Deck One, then automatically activate Deck Two to begin playing when the tape in Deck One is through. 1-2 will appear on the Front Panel Display.

With *loop play*, your Dual-Deck VCR will play a tape in Deck One, then automatically activate Deck Two to begin playing. The tape in Deck One will rewind while the tape in Deck Two is playing. When the tape in Deck Two finishes, it will automatically rewind and the tape in Deck One will play again. This process will continue until you press **[STOP]**. LOOP will appear on the Front Panel Display.

To activate Sequential or Loop play:

1. Press **[MENU]** to bring up the Features menu.
2. Press **(6)** to highlight Playback Mode.
3. Use **[CHANGE]** (LCV button) to cycle between SEQ, LOOP and NORM.
4. When the desired choice is on the screen, press **[MENU]** twice to exit the menu system.

Tracking

Occasionally, when you play a tape that was recorded on a different VCR or on a VHS camcorder, visual noise (white streaks) may appear on the screen. This means the recorded tracks do not align precisely with the playback heads on your VCR.

Your Dual-Deck VCR is equipped with an Automatic Digital Tracking System. This system is activated whenever you insert a tape to play. You'll see ATR on the on-screen display and the ATR indicator is on.

Sometimes, however, you may need to use the manual tracking keys to adjust the picture. Press the TRACKING **[▲]** & **[▼]** keys (these are also the **(2)** and **(3)** buttons) to move the white streaks up or down and out of the picture. When you do this, the Automatic Digital Tracking System is disabled. The ATR indicator on the front panel is off. It can be reactivated by pressing **[PLAY]** on the remote control or front panel for 1.5 seconds.

Copying a Tape

You may use the Copy Tape feature to copy a tape from Deck One to Deck Two.

NOTE:

EP is 3 times longer than SP. Speed Matching in the Features menu must be off for you to change copy recording speed on Deck Two. If Speed Matching is on, the recording speed will automatically adjust to the same as the current play speed in Deck One.

NOTE:

While using the Copy Tape feature, you can view a TV program while copying a tape by pushing the TV/VCR key to TV and change channels on your TV or use VIEW to select Tuner and then select the channel on your VCR.

NOTE:

Optimum results will be obtained when using HQ1 if the source type is in SP or any tape with Copy Guard.

For source tapes in EP or LP without Copy Guard use HQ2 for best results.

To perform special effects copy such as 'still' and 'slow' HQ Copy must be set to HQ2.

1. Make sure the tape in Deck Two is long enough to record the entire tape in Deck One. A T-120 tape may not copy the entire tape if the source tape is longer than 2 hours.

You can change the recording time on the tape in Deck Two by changing the Record Speed in the Deck Two menu. Speed Matching must be off.

2. Insert your source tape into Deck One at the top of the Dual-Deck VCR. Insert your blank tape into Deck Two at the bottom of your VCR.
3. Press **COPY** on your remote control or on the front panel of your VCR.

Your Dual-Deck VCR will now make a copy of your tape.

If you wish to pause in the copying process, press **COPY** again. To resume copying, press **COPY** again. To stop the copying process, press **STOP** on Deck Two.

See page 33 for an explanation of EZ Copy.

Summary of Recording Speeds		
VHS	SP	EP (SLP)
T-120	2 hrs	6 hrs
T-160	2 hrs 40 min	8 hrs
T-180	3 hrs	9 hrs
T-200	3 hrs 20 min	10 hrs

Recording a TV Program

You can record TV shows onto a tape in either Deck One or Deck Two.

1. Insert a blank tape into the Deck. Make sure it is long enough to tape the whole program. You can change the length of the tape by changing the Recording Speed in the Deck One or Two menu.
2. On the Dual-Deck VCR (or cable converter box is you have one), select the channel you want to record.
3. Press **RECORD** to begin recording on the active deck.

While you are recording the TV show, you can:

Pause the recording by pressing **PAUSE** and start recording again by pressing **RECORD**.

One-Touch Recording (OTR) • Use to record in 30 minute increments. Each time you press **RECORD** after the first time, you add another 30 minutes to the record time. For example, if you press **RECORD** three times, the VCR will record for 60 minutes. The Front Panel Display will show the length of recording time programmed. After the elapsed time, the deck will stop. Or if the **POWER** key is pressed during OTR, the VCR will turn off after recording is complete.

Loop Record • Keep pressing **RECORD** until you see 9:30 on the Front Panel Display. Press once more and you will begin Loop Record. The tape will record until it reaches the end of the tape. The tape will then automatically rewind and begin recording again.

Watch a different channel by pressing **TV/VCR**, then using your TV's tuner to select the new channel.

AUX • Press '0' button twice to enable AUX IN. Audio/Video Line Input (see pages 32 and 48) to watch or record input from other video sources — laser disc, satellite receiver, camcorder or other VCRs, etc.

Record TV Program While Playing a Video

Tape • If you want to record a TV program while already playing a tape, change the record source to the desired setting (see page 38) and start recording. You can then change the view to continue watching the tape on the other Deck.

NOTE:

The **POWER** key does not function during Loop Record to prevent accidental termination of the recording. Loop Record must be stopped by pressing the **STOP** key on the active Deck to restore normal **POWER** key operation.

Setting Timer to Record Later

NOTE:

You must have the VCR's clock set to the correct date and time for Timer Recording to work. If the clock is not set, that menu will automatically come up before you can program a Timer Recording.

You can program your Dual-Deck VCR to record TV shows at a later time. You can program up to eight Timer Recording events (shows): 4 on Deck One and 4 on Deck Two.

```

DECK TWO/ONE MENU

1 : RECORD SPEED      SP
2 : TAPE LENGTH      T120
3* : TIMER RECORDING
4 : RECORD SOURCE    AUTO
5 : HI-FI AUDIO      ON

PRESS SELECT/CHANGE TO
SET AND MENU WHEN DONE
    
```

1. Press **MENU** until you see the Deck Two or Deck One menu on the screen.
2. Press **3** to select Timer Recording.

```

DECK 2 TIMER RECORDING
10:20PM 12/11'96(WED)

1
2
3
4

CHOOSE EVENT [1-4]
1234
PRESS 1-4 TO SET EVENT
AND MENU WHEN DONE
    
```

3. Enter the number of the event you wish to set (1-4).
4. Enter the following information:

```

DECK 2 TIMER RECORDING
10:20PM 12/11'96(WED)
1 c1 ---- --AM --AM A
2
3
4

CHOOSE CHANNEL/AUX

PRESS 0-9/100 TO SET
ERASE=[CLEAR] END=[MENU]
    
```

Channel (or source) you wish to record

• Use the numerical buttons and remember to enter a 0 first if the channel is a single digit. Choose 00 for audio-video line input (AUX). See pages 32 and 48.

```

DECK 2 TIMER RECORDING
10:20PM 12/11'96(WED)
1 c118 DATE ---AM ---AM A
2
3
4

ONCE=[1]      DAILY=[2]
WEEKLY=[3]   ALWAYS=[4]
PRESS 1-4 TO SET
ERASE=[CLEAR] END=[MENU]
    
```

Type of event - Press:

- 1: Once - records one event at a time.*

DECK 2 TIMER RECORDING
 10:20PM 12/11'96(WED)
 1 c118 11 ---AM ---AM A
 2
 3
 4
 ENTER START DATE
 PRESS 0-9 TO SET
 ERASE=[CLEAR] END=[MENU]

* **Date** - If you selected *Once*, you will be asked to enter the day (01-31) when you which timer recording to start.

DECK 2 TIMER RECORDING
 10:20PM 12/11'96(WED)
 1 c118 MO-FR-- ---AM ---AM A
 2
 3
 4
 ENTER START HOUR
 PRESS 0-9 TO SET
 ERASE=[CLEAR] END=[MENU]

2: Daily - records one event at the same time every weekday.

DECK 2 TIMER RECORDING
 10:20PM 12/11'96(WED)
 1 c118 WKLY ---AM ---AM A
 2
 3
 4
 SUN=1 MON=2 TUE=3 WED=4
 THU=5 FRI=6 SAT=7
 PRESS 1-7 TO SET
 ERASE=[CLEAR] END=[MENU]

3: Weekly - records one event at the same time every week.
 You will then be asked to program which day of the week (Sun - Sat).

DECK 2 TIMER RECORDING
 10:20PM 12/11'96(WED)
 1 c118 SU-SA-- ---AM ---AM A
 2
 3
 4
 ENTER START HOUR
 PRESS 0-9 TO SET
 ERASE=[CLEAR] END=[MENU]

4: Always - records one event at the same time every day.

```

DECK 2 TIMER RECORDING
  10:20PM 12/11'96(WED)
  1 c118 WKLYFR ---AM ---AM A
  2
  3
  4
    ENTER START HOUR

    PRESS 0-9 TO SET
    ERASE=[CLEAR] END=[MENU]
  
```

```

DECK 2 TIMER RECORDING
  10:20PM 12/11'96(WED)
  1 c118 WKLYFR 12:24AM 1:56AMA
  2
  3
  4
    ENTER RECORD SPEED
    SP=[1] EP=[2] AUTO=[3]
    PRESS 1-3 TO SET
    ERASE=[CLEAR] END=[MENU]
  
```

```

DECK 2 TIMER RECORDING
  10:20PM 12/11'96(WED)
  1 118 MO-FR 2:00AM 2:30AM EP
  2 5 SU-SA 10:00PM 11:00PM SP
  3 AUX WKLYSU 8:15AM 9:25AM SP
  4 45 15 6:00PM 7:00PM A
    CHOOSE EVENT [1-4]
    1234
    PRESS 1-4 TO SET EVENT
    AND MENU WHEN DONE
  
```

NOTE:

A blinking event number indicates the event is in progress.

To stop an event in progress, the event must be 'deleted' from the Timer Recording menu. The [STOP] button will not stop an event in progress.

Start Time • Enter hour and minute you want recording to start. If the show starts at 8:00, enter 08 00 and then enter 1 for AM or 2 for PM.

End Time • Enter hour and minute you want recording to stop. If the show stops at 8:00, enter 08 30 and then enter 1 for AM or 2 for PM.

Record Speed • Press 1 for SP, 2 for EP and 3 for AUTO, (Complete Program Record).

In the AUTO, or Complete Program Record, setting the Dual-Deck will automatically select the recording speed which will give you the best quality for the time remaining on the tape. SP gives you the best quality and this speed is automatically selected initially. If the VCR determines there is not enough time on the tape to record the entire selection, it will automatically change the speed to EP. You will notice some difference in quality if this happens. Be sure to set the correct tape length for Deck Two in the Deck Two menu and for Deck One in the Deck One menu (item #2) so this feature works properly.

5. Press [MENU] to save your settings and go to Deck Two/One menu. Press 3 to see a summary of the events you have programmed to record, and [MENU] when done.
6. Press [MENU] again to exit programming.

To delete an event, press the number of that event to highlight it and then press [CLEAR] on the remote control.

FEATURES MENU

1 * SETUP MENU
 2 : COPY MODE HQ1
 3 : SPEED MATCHING ON
 4 : COPY AUDIO INSERT OFF
 5 : EZ-COPY OFF
 6 : PLAYBACK MODE NORM
 7 : RECORD MODE NORM
 PRESS SELECT/CHANGE TO
 SET AND MENU WHEN DONE

SETUP MENU

1 : SET CLOCK/LANGUAGE
 2 : TUNER SETUP MENU
 3 : AUTO PLAY/REWIND BOTH
 4 : ON-SCREEN DISPLAY AUTO
 5 * DATE/TIME STAMP ON
 6 : SECOND TV VIEW AUTO
 7 : AUX INPUT FRONT
 PRESS SELECT/CHANGE TO
 SET AND MENU WHEN DONE

Date/Time Stamp

You can record the Date and Time of both regular and Timer recordings. Together with the VISS-Automatic Show Finder feature (see page 28), this allows you to easily find a specific program on a tape with several programs recorded on it.

To activate the Date and Time Stamp:

1. Press **MENU**. The Features menu will appear.
2. Press **1**. The Setup menu will appear.
3. Press **5** to highlight DATE/TIME STAMP.
4. Press **CHANGE** (LCV button) to cycle between off and on.
 OFF - No Date and Time Stamp will be recorded.
 ON - Date and Time Stamp will be recorded on your tapes.
5. When your desired choice is displayed, press **MENU** to exit the Setup menu. Press **MENU** twice more to exit programming.

If you have activated the Date and Time Stamp, the Date, Time and Channel information will be recorded at the beginning of each recording for about 5 seconds. Date and Time Stamp does not record when you are doing a Copy Tape.

Video Tape Editing

With your Dual-Deck VCR you can edit tapes quickly and easily. Your editing may be as simple as removing unwanted scenes from your camcorder recordings. Or it may be as complicated as shooting a number of scenes, reviewing the tape, deciding on a final format, and putting it back together.

Sync Edit

You can do assembly editing manually with your Dual-Deck VCR. For example, when you have different scenes from a source tape that you would like to add to a target tape, insert the source tape into Deck One, the target tape into Deck Two and:

1. Position the source tape in Deck One to the beginning of the first scene you want to copy onto the target tape in Deck Two and press Pause.
2. Press the Copy button to start Copy Tape.

NOTE:

The faster the speed, the better quality copy you will get. The highest quality editing will result when you use SP to record regardless of the source speed. Copies made from EP source tapes are subject to picture degradation because of the slow speed.

NOTE:

The Copy Audio Insert feature allows you to add taped music or your own pre-recorded voice-over while editing a video tape, replacing the tape's original audio track. See page 32.

NOTE:

During Copy Tape, pressing the Copy button pauses the copying process. To resume copying, press the Copy Tape button again. To stop Copy Tape, press Deck Two Stop.

NOTE:

When assembling several scenes on one target tape, you can make more accurate edits by first playing the target tape to 2 seconds after the end of a scene, press Pause, then Record to put Deck Two into Record Pause. When you then re-start Copy Tape the target tape will be in position for the best edit.

3. Press Deck Select to select Deck One. At the end of the scene press Stop, (Deck Two will automatically pause). If desired, you can now change the source tape in Deck One at this time. Using Play, Fast Forward or Rewind, locate the next scene you want to edit in. When the tape is positioned at the beginning of the edit scene, press Pause.
4. Press the Copy Tape button and the VCR will automatically perform the synchronized edit.
5. To add the next scene, start over with Step 3.

You might find manual editing easier if you program both AUTO PLAY in the Set-up menu and EZ-COPY in the Features menu to OFF, and perform your edit with the On-Screen Display turned on.

Skip Edit

During Copy Tape, you can quickly by-pass commercials by pressing the Skip button one to five times. The Dual-Deck will automatically edit out the next one to five minutes then resume copying the tape.

Tape Counter

NOTE:

For making quality edits, turn on HQ Copy (Features menu) to get better quality tape copy and edits. 'Glitches' may occur during a manual assembly edit, usually at the end of a scene that is being recorded over old material. This happens because the VCR's full erase head (which erases the video, audio, and control tracks) is always a few seconds behind the recording heads. You may see a vibrating rainbow of color in the middle of the picture and sound can become unstable for a few seconds.

Your Dual-Deck VCR Tape Counter allows you to note the location of specific sections of your tapes and find them quickly later. This tape counter counts in real time - hours, minutes, and seconds.

You can see the tape counter for both decks on the On-Screen Display. You can also see the tape counter for the active deck on the Front Panel Display (pressing the CLK/CTR key repeatedly switches the display between the clock and the counter).

To reset the tape counter to zero on the active deck press **[CLEAR]**. You can do this anywhere on a tape.

Any time you insert a tape into your Dual-Deck VCR, the tape counter will automatically reset to zero. It is recommended that the counter be reset to zero after a full rewind.

ASF - Automatic Show Finder

NOTE:

The Dual-Deck VCR may miss an Index mark if the mark is very close to the current location, or it is at the beginning of the tape, or if it is within 5 minutes of another VISS mark.

You can also place Index marks during a recording by pressing INDEX.

```
DECK TWO INDEX MENU  
  
INDEX: --  
  
SCAN=[FFWD]/[REW]  
SEARCH=[#]-[FFWD]/[REW]  
EXIT=[INDEX]  
  
PRESS FFWD OR REW KEY TO  
START INDEX SCAN OR 1-99  
AND DIRECTION FOR SEARCH
```

The Dual-Deck VCR has an Automatic Show Finder feature. This feature combines the date/time stamp plus the VHS Index Search System (VISS). VISS is the VHS standard, so you can use the Dual-Deck VCR index system with tapes made on other VCRs and VHS camcorders that also use the VISS system.

The Dual-Deck VCR automatically records an Index Mark on the tape each time you begin recording. You will see IDX flash on the on-screen display.

You can locate these Index marks in two ways:

Index Scan:

1. Use **DECK SELECT** to choose the active deck.
2. With a tape in the active deck, press **INDEX** on the remote control. The INDEX menu will appear on your screen.
3. Press **FF** to scan for Index marks forward, or **REW** to scan for Index marks in reverse. The Index Scan display will appear and the deck will fast wind and play a few seconds of tape at each index mark it encounters; it will then continue to fast wind to the next index mark.
4. Press **STOP** or **PLAY** when you reach the desired Index mark or see the section of tape you want.

Index Search:

1. Use **DECK SELECT** to choose the active deck.
2. With a tape in the active deck, press **INDEX** on the remote control. The INDEX menu will appear on your screen.
3. Use the numerical keys to enter an index value. This value is the number of Index marks you want the VCR to count before it stops.

Note: Enter a 0 first for Index marks 1-9.

4. Press **FF** to search for Index marks forward, or **PLAY** to search for Index marks in reverse. The Index Search display will appear and the deck will start to fast wind. When the VCR reaches the indicated Index mark, it will stop and play the tape.



Programming Your Dual-Deck VCR

On-Screen Menu System

The On-Screen Menu System allows you to easily set up your Dual-Deck VCR to:

- Make Recordings (including timer recordings)
- Copy Tapes
- Set the antenna
- Set the channel memory
- Set the clock
- Change automatic features

Many of the menu items come pre-programmed to the most common setting. Some settings you may never need to change. However, as you learn more about your Dual-Deck VCR, you may decide to change some of the settings.

To use the On-Screen menu System:

- Press **[MENU]** on the remote control. The Features menu will appear. Press **[MENU]** again when you wish to exit on-screen programming and save your changes. Pressing this key will automatically step you out of the menu system.
- **[SELECT]** (Mute button): Use this key while in the On-Screen menu to move to the menu item you wish to select. The asterisk indicates the various menu items and item number will blink. This key is also used to move you to the next selection in the set Date/Time and Timer Record menus.
- **[CHANGE]** (LCV button): Use this key to cycle through the choices of the menu item you selected.
- **[CLEAR]**: Use this key to erase any timer events you have programmed.

NOTE:

*If menu background color is blue, pressing **[MENU]** 1 to 2 times will exit programming. If menu background is green, pressing **[MENU]** 3 to 5 times will exit programming*

NOTE:

*If you press **[MENU]** while viewing a Deck, the menu for that Deck will appear instead. To get to the Features menu, press **[MENU]** again.*

NOTE:

*If you get the Features menu, and want the Deck One or Two menu, press **[MENU]** again.*

FEATURES MENU

1 * SETUP MENU
 2 : COPY MODE HQ1
 3 : SPEED MATCHING ON
 4 : COPY AUDIO INSERT OFF
 5 : EZ-COPY OFF
 6 : PLAYBACK MODE NORM
 7 : RECORD MODE NORM
 PRESS SELECT/CHANGE TO
 SET AND MENU WHEN DONE

SETUP MENU

1 : SET CLOCK/LANGUAGE
 2 : TUNER SETUP MENU
 3 : AUTO PLAY/REWIND BOTH
 4 : ON-SCREEN DISPLAY AUTO
 5 * DATE/TIME STAMP ON
 6 : SECOND TV VIEW AUTO
 7 : AUX INPUT FRONT
 PRESS SELECT/CHANGE TO
 SET AND MENU WHEN DONE

*** NOTE:**

If you press [MENU] and do not get the Features menu, continue pressing [MENU] until you see the Features menu.

Menus

Press [MENU] to get the Features menu. The Setup menu will be indicated. Press ① to select this menu.

Setup Menu [Menu, 1]*

Set Clock/Language Menu [Menu, 1,1]

Refer to page 15 to program this menu.

Note: *If the clock is not set, pressing [MENU] will bring up the Set Language and then the Set Clock menu.*

Tuner Setup Menu [Menu, 1,2]*

Refer to page 35 to program this menu.

Auto Play/Rewind [Menu, 1,3]*

If you select BOTH, this means tapes with no record safety tab (such as rented movies) will automatically play when inserted and rewind when finished playing. If you select OFF, the tape does not automatically play or rewind. Or you can select to either auto rewind or auto play.

1. Press ③ to select this item. Subsequent pressings of this number will cycle this feature between BOTH, PLAY, REW, and OFF.

You can also use [SELECT] (Mute button) to highlight this item and [CHANGE] (LCV button) to change this feature.

2. When the desired setting is shown on the screen, either press [MENU] to exit this menu or move to another item.

On-Screen Display [Menu, 1,4]*

This option allows you to determine whether the On-Screen Display (OSD) displays automatically or whether you have to press the [OSD] button to bring up the display.

1. Press ④ to select this item. Subsequent pressings of this number will cycle this feature between AUTO and OFF.

You can also use [SELECT] (Mute button) to highlight this item and [CHANGE] (LCV button) to change this feature.

2. When the desired setting is shown on the screen, either press [MENU] to exit this menu or move to another item.

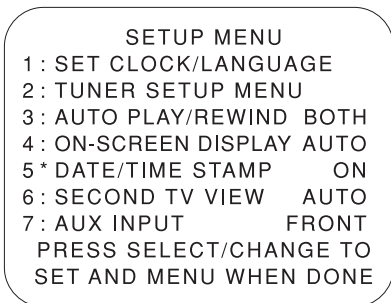

*** NOTE:**

*If you press **[MENU]** and do not get the Features menu, continue pressing **[MENU]** until you see the Features menu.*

Date/Time Stamp [Menu, 1, 5]*

This option allows you to determine if you want the current date and time recorded onto the beginning of your recording. Select OFF if you don't want the current date and time recorded; select ON if you do want the date and time recorded.

1. Press **(5)** to select this item. Subsequent pressings of this number will cycle this feature between ON and OFF.

You can also use **[SELECT]** (Mute button) to highlight this item and **[CHANGE]** (LCV button) to change this feature.

2. When the desired setting is shown on the screen, either press **[MENU]** to exit this menu or move to another item.

Second TV View [Menu, 1, 6]*

This option allows you to send audio/video signals to a separate second monitor.

If you select Auto, the signal is the same as the main TV view. The picture selected with the **[VIEW]** key is available to both monitors at the same time.

Select either Deck One, Deck Two, Tuner or AUX when you want the second audio/video output to remain fixed regardless of the TV view.

1. Press **(6)** to select this item. Subsequent pressings of this number will cycle this feature between AUTO, Deck One, Deck Two, Tuner and AUX.

You can also use **[SELECT]** (Mute button) to highlight this item and **[CHANGE]** (LCV button) to change this feature.

2. When the desired setting is shown on the screen, either press **[MENU]** to exit this menu or move to another item. Use the rear panel output jacks to hook up the second monitor, see page 00.

SETUP MENU
 1 : SET CLOCK/LANGUAGE
 2 : TUNER SETUP MENU
 3 : AUTO PLAY/REWIND BOTH
 4 : ON-SCREEN DISPLAY AUTO
 5 * DATE/TIME STAMP ON
 6 : SECOND TV VIEW AUTO
 7 : AUX INPUT FRONT
 PRESS SELECT/CHANGE TO
 SET AND MENU WHEN DONE

*** NOTE:**

*If you press **[MENU]** and do not get the
 Features menu, continue pressing **[MENU]**
 until you see the Features menu.*

AUX Input [Menu, 1, 7]*

This option allows you to select the incoming signal if you have already selected AUX for your record source or TV view. If you select Front, the incoming signal will be from the front panel jacks; If you select the Rear, the incoming signal will be from the rear audio/video jacks.

1. Press **7** to select this item. Subsequent pressings of this number will cycle this feature between front and rear.

You can also use **[SELECT]** (Mute button) to highlight this item and **[CHANGE]** (LCV button) to change this feature.

2. When the desired setting is shown on the screen, either press **[MENU]** to exit this menu or move to another item.

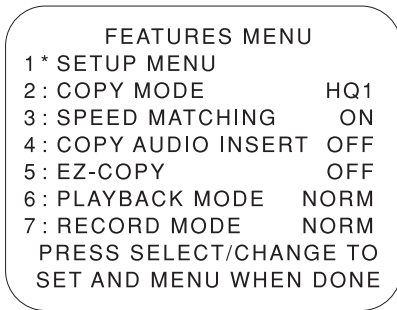

*** NOTE:**

*If you press **[MENU]** and do not get the Features menu, continue pressing **[MENU]** until you see the Features menu.*

Features menu

Copy Mode [Menu, 2]*

HQ Copy uses Go-Video's patented AmeriChrome Circuitry for optimum duplicating results. You can choose HQ1 or HQ2 depending on your particular needs.

Optimum results will be obtained when using HQ1 if the source tape is in SP or any tape with Copy Guard.

For source tapes in EP or LP without Copy Guard, use HQ2 for best results.

1. Press **(2)** to select this item. Subsequent pressings of this number will switch this selection between HQ1 and HQ2 modes.

You can also use **[SELECT]** (Mute button) to highlight this item and **[CHANGE]** (LCV button) to change this feature.

2. When the desired setting is shown on the screen, either press **[MENU]** to exit this menu or move to another item.

Speed Matching [Menu, 3]*

Speed matching automatically sets the record speed to be the same as the current playback tape. You will get the best quality copy when this feature is turned ON.

1. Press **(3)** to select this item. Subsequent pressings of this number will turn this feature ON or OFF.

You can also use **[SELECT]** (Mute button) to highlight this item and **[CHANGE]** (LCV button) to change this feature.

2. When the desired setting is shown on the screen, either press **[MENU]** to exit this menu or move to another item.

NOTE:

If this feature is OFF, check the record speed on Deck Two before copying a tape to be sure it is set as you want it.

Copy Audio Insert [Menu, 4]*

The Dual-Deck's Copy Audio Insert feature allows you to add taped music or voice-overs to a video tape copy, replacing the tape's original audio track.

When Copy Audio Insert is ON, the audio signal comes from your AUX IN input source (Audio In jack on the Front Panel) instead of from the tape in Deck one being copied.

1. Press **(4)** to select this item. Subsequent pressings of this number will cycle this feature between ON and OFF.

You can also use **[SELECT]** (Mute button) to highlight this item and **[CHANGE]** (LCV button) to change this feature.

NOTE:

Copy Audio Insert, EZ-Copy, Playback Mode and Record Mode automatically reset to OFF and Normal when the VCR power is turned off to prevent accidental use.

2. When the desired setting is shown on the screen, either press **MENU** to exit this menu or move to another item.

EZ-Copy [Menu, 5]*

When EZ-Copy is ON, tapes rewind before playback begins and at the conclusion of a copy tape, both decks will rewind, eject tapes, and the power will turn off if the Auto Power Off mode is active.

1. Press **5** to select this item. Subsequent pressings of this number will change this feature between ON and OFF.

You can also use **SELECT** (Mute button) to highlight this item and **CHANGE** (LCV button) to change this feature.

2. When the desired setting is shown on the screen, either press **MENU** to exit this menu or move to another item.

Playback Mode [Menu, 6]*

Select SEQ if you want Sequential Play, and LOOP if you want Loop Play. See page 20 for a discussion of Sequential and Loop Play modes. Select NORM if you want to play a tape normally without sequencing or looping with the other deck.

1. Press **6** to select this item. Subsequent pressings of this number will cycle this feature between NORM, SEQ, and LOOP.

You can also use **SELECT** (Mute button) to highlight this item and **CHANGE** (LCV button) to change this feature.

2. When the desired setting is shown on the screen, either press **MENU** to exit this menu or move to another item.

Record Mode [Menu, 7]*

NOTE:

*The **POWER** key does not function during Loop Record to prevent accidental termination of the recording. Loop Record must be stopped by pressing the **STOP** key on the active Deck to restore normal **POWER** key operation.*

Loop Record • Your Dual-Deck VCR will record on a tape in Deck One, then automatically activate Deck Two to begin recording. The tape in Deck One will rewind while the tape in Deck Two is recording. When the tape in Deck Two finishes, it will automatically rewind and the tape in Deck One will begin recording again. This process will continue until you press the STOP button. LOOP will appear on the Front Panel Display.

Sequential Record • Your Dual-Deck VCR will record on a tape in Deck One, then automatically activate Deck Two to begin recording when the tape in Deck One is finished. When finished each tape will automatically rewind and stop. 1-2 will appear on the Front Panel Display.

Normal Record • Your Dual-Deck VCR will begin recording a tape in whichever Deck you activate by pressing the REC button.

1. Press ⑦ to select this item. Subsequent pressings of this number will cycle this feature between NORM, SEQ, and LOOP.

You can also use (Mute button) to highlight this item and (LCV button) to change this feature.

2. When the desired setting is shown on the screen, either press to exit this menu or move to another item.

SET CLOCK/LANGUAGE

1 * SET TIME AND DATE
2 : SET LANGUAGE

PRESS SELECT/CHANGE TO
SET AND MENU WHEN DONE

SET TIME AND DATE

[TIME] -- : -- AM

[MONTH] [DATE] [YEAR]
1 / 1 / '96
MON

PRESS 0-9 TO SET
AND MENU WHEN DONE

SET LANGUAGE
SELECCION DE IDIOMA

1 * ENGLISH/INGLES
2 : SPANISH/ESPAÑOL

PRESS SELECT/CHANGE TO
SET AND MENU WHEN DONE

OPRIMA SELECT/CHANGE Y
MENU PARA TERMINAR

Set Clock/Language Menu [Menu, 1,1]*

The Set Clock/Language menu allows you to set the date and time and determine in which language you want your Dual-Deck VCR menu system.

Set Time and Date [Menu, 1,1,1]*

While in the Set Clock/Language menu, press ①. Use the numeric keys and follow the prompt to determine what date you want to enter. You will be prompted to set Hour, Minute, and AM (1) or PM (2), Month, Day, and year.

All fields (except AM/PM) are two-digits long, so remember to enter a 0 as the first digit for a one-digit entry. For example, enter January as 01. For the year, enter the last two digits, such as 95 for 1995.

When you are through entering information, press **MENU** to return to the Set Clock/Language menu.

Set Language [Menu, 1,1,2]*

1. While in the Set Clock/Language menu, press ②. You are now in the Set Language menu.
2. Press ① if you want the menu in English; press ② if you want the menu in Spanish.

Note: *If you accidentally select the language you don't want, you can reset the display by unplugging the VCR for at least 60 seconds.*

* NOTE:

*If you press **MENU** and do not get the Features menu, continue pressing **MENU** until you see the Features menu.*

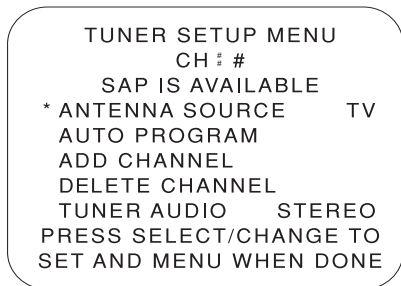

*** NOTE:**

If you press **[MENU]** and do not get the Features menu, continue pressing **[MENU]** until you see the Features menu.

Tuner Setup Menu [Menu, 1,2]*

Use the Tuner/Channel menu to set your antenna source and channel memory. While in the Setup menu, press **(2)**.

Antenna Source

Set your antenna source. Use **[CHANGE]** (LCV button) to switch between the following options: TV and CATV. Select TV if you do not have cable. If you subscribe to cable, select CATV.

Auto Program

Use **[SELECT]** (Mute button) to move to this item. Press **[CHANGE]** (LCV button) to begin automatically programming channels into memory. Auto Program goes through all the possible TV or cable channels one by one. Any time it finds a channel with a signal (a channel that you receive), it programs that channel into channel memory. Once you have run Auto Program, the channel selector on your Dual-Deck VCR or remote control will stop only at the channels which you receive.

Add Channel, Delete Channel

You can add or delete any channel by using the number keys to tune in to that channel, then using the **[SELECT]** (Mute button) key to move to Add or Delete and then pressing **[CHANGE]** (LCV button).

NOTE:

For your convenience, the Tuner Audio has been set to Stereo (SP) at the factory.

During normal operation, the Tuner Audio output is displayed on line 3 of the on screen display. When the Menu setting is Mono, Mono is displayed on line 3. When the menu setting is Stereo, SAP or TV+SAP, line 3 will display the audio currently being received on the tuned channel.

While in Tuner Setup menu, line 3 will display 'SAP IS AVAILABLE' to alert you when the audio signal being received on the tuned station contains a Second Audio Program (see page 38).

Tuner Audio

This feature sets the audio output from the Dual-Deck VCR tuner. Mono produces monaural sound for all programs. Stereo produces stereo sound if the program is broadcast in stereo; otherwise the sound is mono. SAP produces Second Audio Program sound, usually a second language. All SAP broadcasts are mono. TV+SAP produces normal sound from one speaker and SAP sound from the other.

1. Press **(5)** to select this item. Subsequent pressings of this number will cycle this feature between Stereo, Mono, SAP and TV+SAP.

You can also use **[SELECT]** (Mute button) to highlight this item and **[CHANGE]** (LCV button) to change this feature.

2. When the desired setting is shown on the screen, either press **MENU** to exit this menu or move to another item.

Secondary Audio Programming (SAP)

Some TV and cable channels broadcast a Second Audio Program, usually another language, along with the regular audio. All Second Audio Program broadcasts are monaural.

When you tune your Dual-Deck VCR to a channel with a Secondary Audio Program, SAP will appear on the Front Panel Display (whether or not you have SAP selected).

When you have selected SAP or TV+SAP for your Tuner Audio, SAP will appear on the Front Panel Display. If you have selected SAP or TV+SAP and the broadcast does not contain a Secondary Audio Program, normal stereo audio will be heard. Sometimes the SAP signal will be present, but there will be no audio broadcast.

Deck One/Deck Two Menu

NOTE:

Press **[MENU]** until you get the desired menu-Deck One or Deck Two.

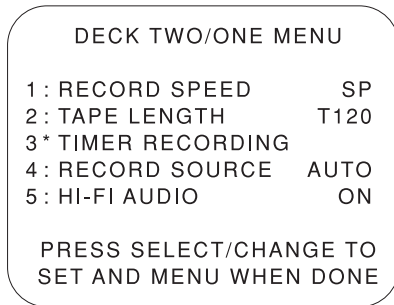

NOTE:

SP will give you the best quality. However, you must determine whether there is enough time on the tape to record the entire selection. If there is not enough time to record the entire selection in SP, you can set record speed to EP. Be sure to set the correct tape length in this menu.

* NOTE:

If you press **[MENU]** and do not get the Features menu, continue pressing **[MENU]** until you see the Features menu.

Record Speed [Menu, 1]*

1. Press **①** to select this item. Subsequent pressings of this number will cycle this feature between SP and EP.

You can also use **[SELECT]** (Mute button) to highlight this item and **[CHANGE]** (LCV button) to change this feature.

2. When the desired setting is shown on the screen, either press **[MENU]** to exit this menu or move to another item.

Tape Length [Menu, 2]

It is important to select what length of tape you are using for the Auto speed setting in Timer Record to work. Note your tape box to see what length tape is.

1. Press **②** to select this item. Subsequent pressings of this number will cycle this feature between T120, T160, T180, and T200.

You can also use **[SELECT]** (Mute button) to highlight this item and **[CHANGE]** (LCV button) to change this feature.

2. When the desired setting is shown on the screen, either press **[MENU]** to exit this menu or move to another item.

NOTE:

The Clock must be set to the correct date and time before this feature will work.

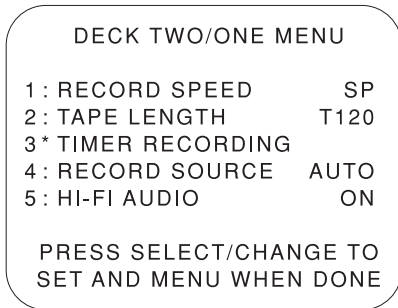

Timer Recording [Menu, 3]

Use the Timer Recording menu when you want to set the Dual-Deck VCR to record at a later time. You can program up to four events (shows) in advance on Deck One and four on Deck Two.

1. Press **3** to select this menu.

When you have selected an event number, you will need to enter the following information for timer recording. You will be asked to choose a source (channel or AUX); select whether you want to record once, daily, weekly or always; set the starting time; the stop time; and the record speed.

- a. Select event (1-4)
- b. Select source (Tuner/Aux)
- c. Select type (Once, Daily, Weekly, Always)
- d. Set start time
- e. Set end time
- f. Set record speed (SP, EP, Auto)

To set the Day, Hour, and Minute, use the numeric keys. All these fields are two-digits long, so remember to enter 0 as the first digit for a one-digit entry. For example, enter January as 01.

For the other fields, enter the number of the desired choice as listed on the menu screen.

Press **MENU** to exit timer record programming and save your information.

Press **CLEAR** to erase a programmed or currently highlighted event.

Timer Record Priorities

Your Dual-Deck VCR must prioritize your Timer Record Events if you accidentally set the Timer to record different events at the same time. The Dual-Deck VCR will:

1. Give priority to the event(s) scheduled on Deck 2.
2. Give priority to the event with the latest starting time. An event in progress will be interrupted by an event with a later starting time.
3. Give priority to the event with the lowest event number. If Event 1 and Event 2 start at the same time, the Dual-Deck VCR will record Event 1.

Note: *If you have a recording event already listed in the timer summary screen which you wish to erase, indicate which event using the **SELECT** (Mute) key, and then press **CLEAR** to erase.*

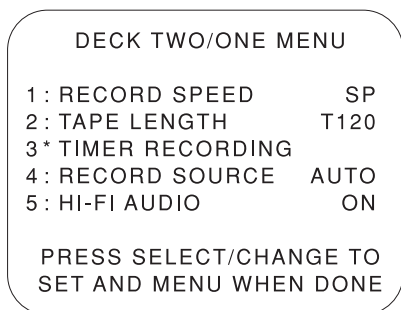

Record Source [Menu, 4]

1. Press **4** to select this item. Subsequent pressings of this number will cycle this feature between AUTO, Deck One, TUNER, and AUX on Deck Two. (Deck One record sources are TUNER and AUX.)

You can also use **SELECT** (Mute button) to highlight this item and **CHANGE** (LCV button) to change this feature.

2. When the desired setting is shown on the screen, either press **MENU** to exit this menu or move to another item.

If AUTO is selected, the current view is automatically selected when the **RECORD** key is pressed.

If Deck One is selected, you will record the tape playing in Deck One or Tuner if Deck One is stopped.

TUNER records the channel you select on your VCR.

When AUX is selected, the incoming signal is from the front or rear panel jacks and this is what is recorded when you press the **RECORD** key.

Hi-Fi Audio [Menu, 5]

When you Select ON, this means that during tape playback you will hear the Hi-Fi audio track on your tape; if you select OFF, you will hear the monaural linear audio track on your tape. This feature is useful when playing a tape with voice-over narration.

1. Press **5** to select this item. Subsequent pressings of this number will cycle this feature between ON and OFF.

You can also use **SELECT** (Mute button) to highlight this item and **CHANGE** (LCV button) to change this feature.

2. When the desired setting is shown on the screen, either press **MENU** to exit this menu or move to another item.

NOTE:

Hi-Fi Audio automatically resets to ON when the VCR power is turned off to prevent accidental omission of the Hi-Fi Audio track during Copy Tape. If Hi-Fi Audio is set to OFF during Copy Tape, the original monaural linear audio track will be copied to both the linear and Hi-Fi audio tracks on the duplicate tape.

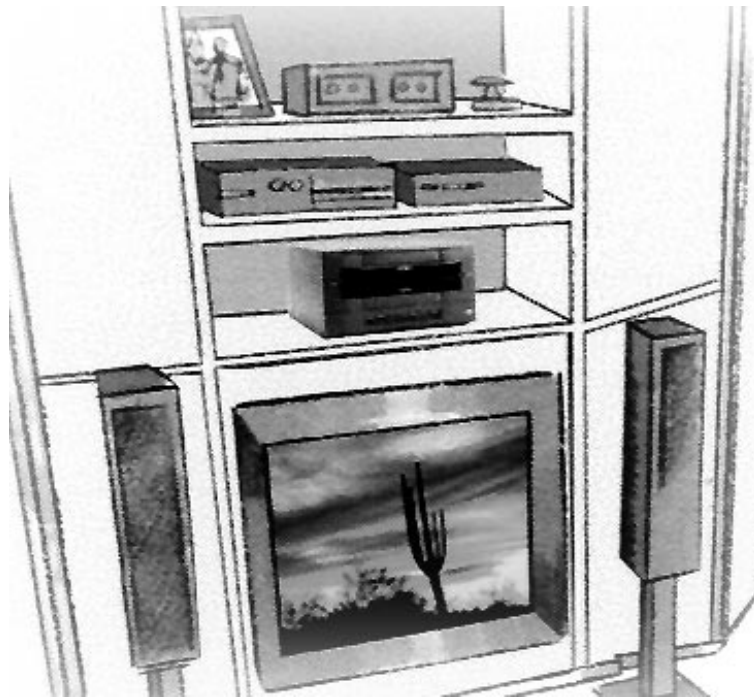



Connecting Your Dual-Deck VCR

To determine the hookup you need:

1. If you don't have a cable system, use the Basic Connections.
2. If you have a cable system but no converter box, use the Basic Cable Connections.
3. If you have a cable system with a converter box (some or all channels are scrambled or premium), use Cable Converter Box Hookup (or Alternative Cable Converter Box Hookup).

Introduction

Your exact hookup will depend on whether or not you subscribe to cable, and whether you have a cable converter box or other equipment. However, the basic idea is the same.

The signal (whether antenna, cable, or satellite) coming into your house needs two things for the program to appear on your TV: cables and tuners.

First, the signal travels through a cable.

Second, the signal goes to a device with a **tuner** such as your TV or VCR. The tuner selects the one channel that you are watching from the many channels that you have available.

After you have chosen the desired channel with this tuner, the device may convert the signal into the audio and video that you see on your television screen, or it may rebroadcast the signal, on a pre-set channel, to another device.

For example, a cable may go into a device with a tuner (a cable box or VCR) and have a cable going from this device into another tuner such as your TV. This means that the channel selected on the first tuner (Cable box or VCR) is the one that the second tuner (TV) will pick up. This is why you select your TV channels using your VCR remote control. The signal is coming to the VCR which tunes in the channel you select and sends that channel to the TV. This is also why, if you have a cable converter box, you select TV channels using the cable converter box.

When one tuner sends a signal for a channel to the next tuner, the first tuner always uses a particular channel of its own to broadcast on. For example, your VCR uses either channel 3 or 4. If your VCR is set to broadcast on channel 3, you must set your TV to channel 3 to receive this signal.

So, to watch TV channel 12, you would tune in channel 12 on your VCR and channel 3 on your TV. Your converter box, if you have one, works the same way.

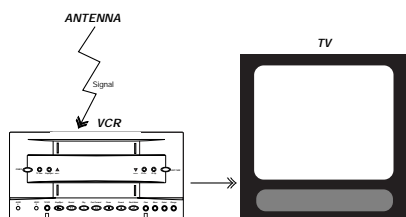

Preparation

Your Dual-Deck VCR connects to your TV and antenna in exactly the same way as any other VCR.

If you already own a VCR, take a few minutes to note how the VCR is hooked up. Then simply swap the Dual-Deck with your old VCR using the same settings and connections.

Here are some things you should take note of in your current hookup:

1. Which cable attaches to the VCR's ANTENNA IN jack on the back of the VCR.
2. Which cable attaches to the TV OUT jack on the back of the VCR.
3. Which channel your TV is tuned to (to watch the VCR).
4. Which channel (3 or 4) is set on the back of your VCR.
5. If you have a cable converter box leading into your VCR, you will need to note which channel (2, 3 or 4) your VCR is tuned to.

Note: Your exact hookup will depend on whether or not you subscribe to cable TV and whether you have a cable converter box or other equipment (such as laser disc player, satellite receiver, etc.).

6. Be sure to insert the two supplied AA batteries in the remote control

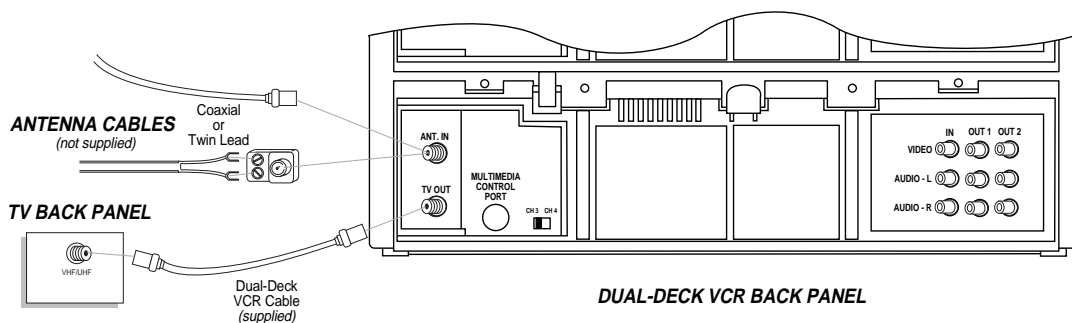

Basic Connections

1. Place your Dual-Deck VCR next to your TV and plug the VCR power cord into a wall outlet. Disconnect all antenna and cable connections.
2. A cable is supplied with your Dual-Deck VCR. Connect one end of this cable to the TV OUT connection on the back of your VCR. Connect the other end of the cable to the VHF IN or CABLE IN connection on the back of your TV.

TIP:

If you are not getting a good picture, try changing the switch on the back of the VCR to CH 4 and then changing your TV to channel 4. If you have a local channel 3, channel 4 might work better for you.

TIP:

If you don't see a menu, look on the front panel display to see if the VCR indicator is lit. If it's not lit, press the TV/VCR key on your remote control to enter VCR mode.

3. Attach the cable from your antenna or cable TV service to the ANT IN connection on the back of your VCR. (If you have a cable converter box, refer to page 43. If your antenna cable is twin-lead, you will need to purchase an adapter, available at your local electronics store.
4. Make sure the switch on the back of the VCR is set to 3.
5. Turn on the power for your VCR and your TV.
6. Turn your TV to channel 3.
7. Press the MENU key on your VCR remote control. You should see a menu. Set the language, date and time now. See page 15. Press MENU again to exit the menu.
8. Use the number keys on your remote control to change to a channel (below 13) in your area. You should be getting a picture.
9. Refer to page 17 on programming your local TV channels into memory.

Separate VHF and UHF Antennas

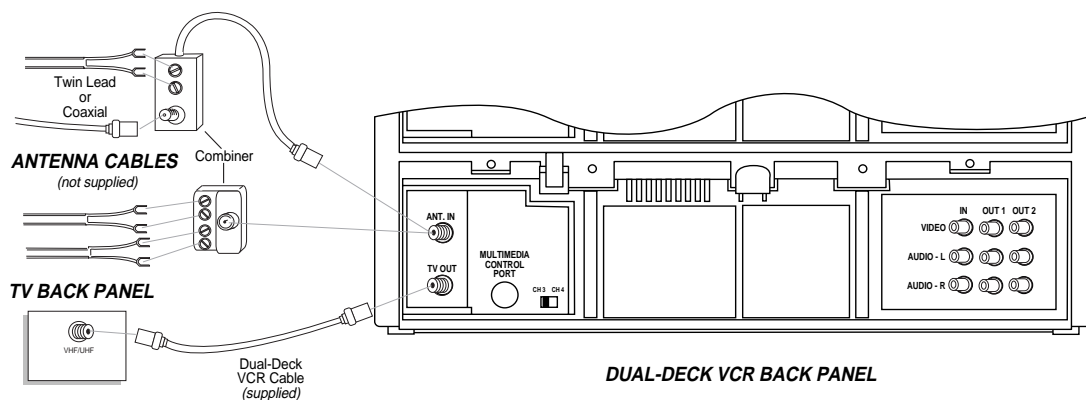

If you have separate VHF and UHF antennas, you will need to purchase a device called a combiner. This attaches to both antenna cables on one side and to a cable which goes to the VCR's ANT IN connection on the other.

Basic Cable Connections

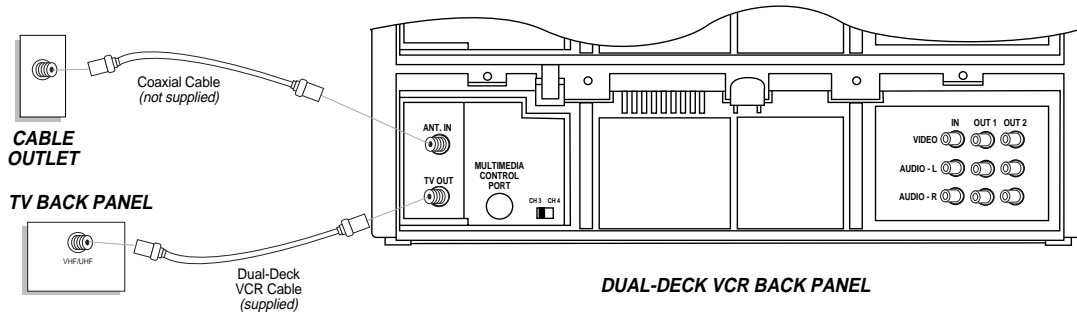

NOTE:

You can record any channel while viewing that channel or any other channel. Your Dual-Deck VCR may be turned off during normal TV viewing.

NOTE:

Most cable systems use scrambled channels for premium programming. This requires the use of a cable converter box. Basic cable connections allow basic, non-scrambled channels to be directly received on your VCR.

Use this connection if your cable system does not require a converter. Refer to Basic Connections to connect your Dual-Deck VCR. Then continue with the following instructions.

1. Turn on your TV and your Dual-Deck VCR.
2. Use the menu system to set the antenna to CATV then program channel memory. See page 17.
3. Press the numeric button or use the Channel Up/Down button to select the channel you want to view or record.

To record one channel and view another:

1. Begin recording the channel you are viewing.
2. Press the TV/VCR button to switch to TV viewing.
3. Select the channel you want to watch with your TV channel selector.

Cable Converter Box Connections

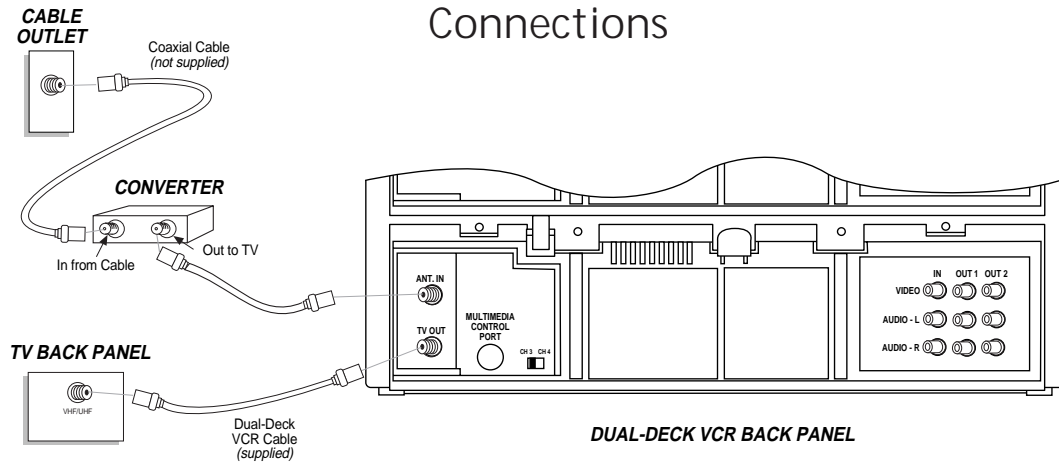

Use these connections if you have a converter box with your cable system. You will be able to record any cable channel which you subscribe to and watch that channel. With these connections (including Timer Record) you must always keep your Dual-Deck VCR tuned to the same channel (2, 3 or 4). You must also select the desired channel for a timer recording on the cable converter box.

1. Place your Dual-Deck VCR next to your TV and plug the VCR power cord into a wall outlet. Disconnect all antenna and cable connections.
2. A cable is supplied with your Dual-Deck VCR. Connect one end of this cable to the TV OUT connection on the back of your VCR. Connect the other end of the cable to the VHF IN or CABLE IN connection on the back of your TV.
3. Attach the cable that comes out of your wall to the input connection on the back of your cable converter box.
4. Attach one end of the cable supplied with your cable converter box to the output connection on the back of the box. Attach the other end to the ANT IN connection on the back of your VCR.
5. Turn on the power for your VCR, TV and converter.
6. Use the numeric keys or the channel up/down buttons to set your VCR to 2, 3 or 4. Call your cable company if you do not know which of these channels to use.
7. Set the Dual-Deck VCR back panel switch to either CH 3 or 4. See pages 39 and 40.

NOTE:

If you don't see a menu, look on the front panel display to see if the VCR indicator is lit. If it's not lit, press the TV/VCR key on your remote control to enter VCR mode.

- 8.** Set your TV to the same channel used in step 7 above.
- 9.** Press the MENU key on your remote. You should see a menu. Set the language and clock at this time, see page 30. Press MENU again until you exit the menu system.
- 10.** Use your cable converter box to select a channel. You should get a picture.
- 11.** You are now ready to use your cable box with your VCR and TV. You may want to check the TUNER SETUP menu. The Antenna Source should be set to TV and the Channel Memory should be set for the cable box channel 2, 3 or 4 only. See pages 17 and 35.

Alternative Cable Converter Box Hookup

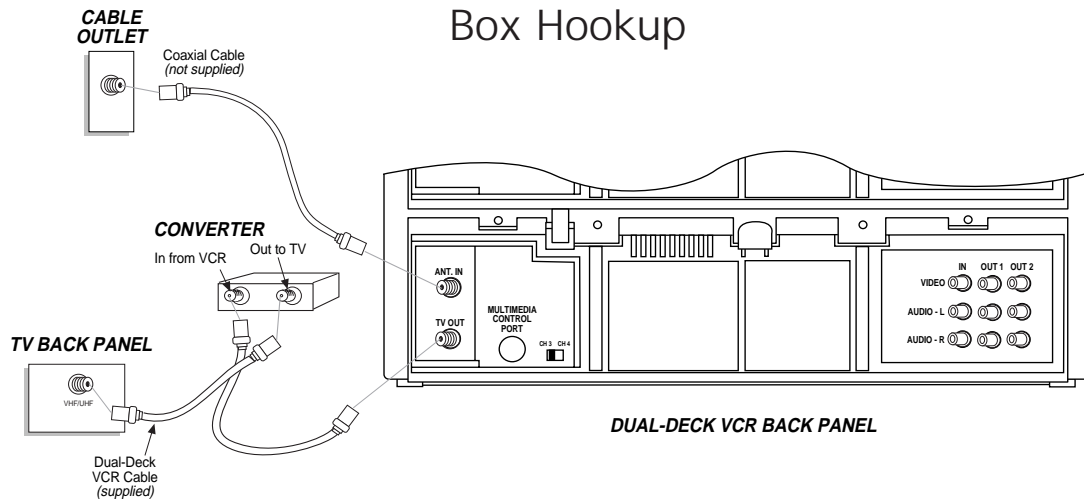

This hookup requires you to use different procedures for watching and recording TV programs than the procedures described in the Operating Section of this manual. It also requires you to change “control” back and forth between your Dual-Deck VCR and your cable converter box. After you have determined what type of connection you will use, you may need to change the VCR’s antenna source. See Tuner Setup menu, pages 17 and 35.

The advantage of this hookup is that it allows you to record a non-scrambled channel only and watch that channel or a selected channel from your cable box at the same time. A disadvantage of this hookup is that it does not allow you to record premium channels that require your cable converter box for descrambling (you can still watch those channels).

1. Place your Dual-Deck VCR next to your TV and plug the VCR power cord into a wall outlet. Disconnect all antenna and cable connections.
2. Using a coaxial cable, connect one end of this cable to the TV OUT connection on the back of your Dual-Deck VCR, and the other end of the cable to ‘input’ on the back of your cable converter box.
3. A cable is supplied with your Dual-Deck VCR. Attach one end of this cable to the output connection on the back of your cable box. Attach the other end to the CABLE IN connection on the back of your TV.
4. Turn your TV to channel 2, 3 or 4, whichever is used by your cable system.
5. With all three devices turned on, tune your cable converter box to channel 3 and push the MENU key. You should see the clock menu. Set the time and

date at this time, see page 34. Press MENU again until you exit the menu system.

6. Attach a coaxial cable to the outlet in your wall and the other end to the ANT IN connection on the back of your VCR.
7. Use the menu System to set the antenna and channel memory, see pages 17 and 35.

With TV/VCR on VCR and the cable box set on 3 or 4, you should see the channel that the VCR is tuned to. With TV/VCR on TV you should see the channel that the cable converter box is tuned to.

To view any basic or premium channel:

1. Set your Dual-Deck VCR's TV/VCR selector to TV (or turn off your VCR).
2. Set the TV to channel 2, 3 or 4, whichever is used by your cable system box.
3. Select the desired channel to view on the cable converter box.

To record and view a basic channel:

1. Set the TV/VCR selector to VCR on your Dual-Deck VCR.
2. Set the TV to channel 2, 3 or 4, which ever is used by your cable system box.
3. Set the cable box to channel 3 or 4, whichever is used as your VCR output.
4. On the Dual-Deck VCR, select the desired channel to view. Start the recording (see page 22).

To record a basic channel while watching any other basic or premium channel:

1. Set the TV/VCR selector to VCR on your Dual-Deck VCR.
2. Set the TV to channel 2, 3 or 4, whichever is used by your cable system.
3. Set the cable box to channel 3 or 4, whichever is used as your VCR output.
4. Set the Dual-Deck VCR to the basic channel you wish to record. Start the recording (see page 22).
5. Set the TV/VCR selector on the VCR to TV.
6. Select the basic or premium channel on the cable box and watch it on your TV.

Monitor Connections

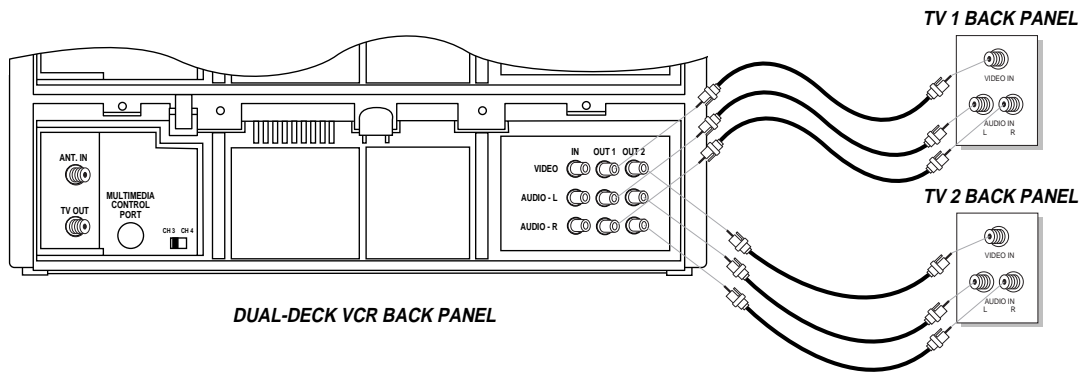

NOTE:

A monitor-style TV is not the same as a computer monitor.

Some Dual-Deck VCR owners may have a monitor-style TV. Monitor-style TVs offer improved picture and sound quality over standard TVs because they receive the video and audio signal directly from the VCR. A standard TV receives the video and audio signal from the VCR indirectly, through what is called an RF modulator. This is a miniature broadcasting station in your VCR that sends the signal to your TV. The TV OUT connection on the back of your Dual-Deck VCR transmits the signal from the RF modulator. The direct VIDEO and AUDIO OUT connections give you better quality than the RF modulator connection, in the same way that a face-to-face conversation is clearer than a conversation through a walkie-talkie.

If practical, use the VIDEO and AUDIO OUT connections on the back of your VCR instead of the TV OUT connection.

NOTE:

See item number 6, Second TV View, in the Setup Menu to program the source for OUT 2.

To view the VCR output on the monitor, you have to switch the monitor to 'VIDEO,' 'AUX,' or 'LINE.' Refer to your monitor owner's manual for the correct setting.

When you use these VIDEO and AUDIO OUT connections instead of the TV OUT connection, the TV/VCR key has no effect on the picture you see when using your VCR. But it still switches the antenna and any device attached to 'TV OUT.'

If you use the AUDIO OUT connections, your stereo TV's speakers will deliver stereo sound. If you use the TV OUT connection, your stereo TV's speakers will deliver mono sound.

Connecting Other Video Equipment

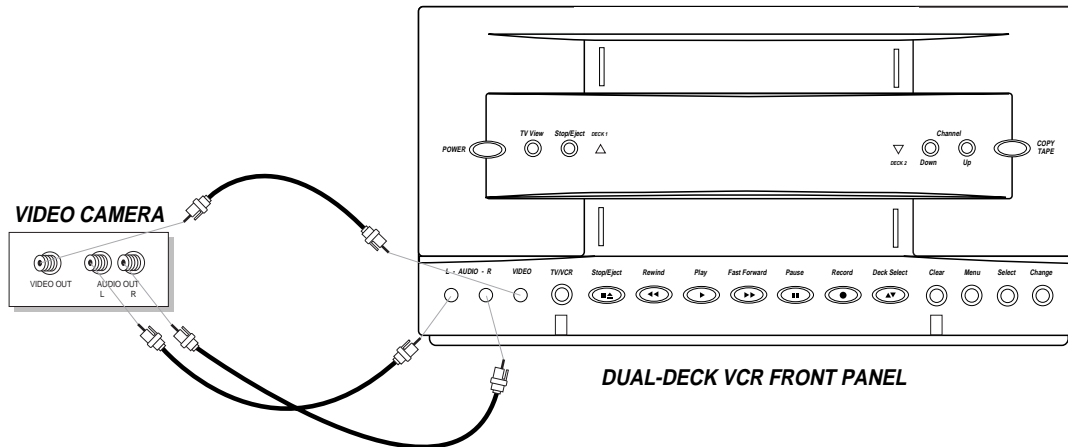

NOTE:

Refer to the Setup Menu, item number 7, AUX Input, to set front or rear auxiliary input.

You can connect other video equipment to your Dual-Deck VCR by using the Video and Audio Input jacks. These jacks are located on the front of the VCR.

Connect another VCR, a laser disc player, a video camera or camcorder, or a satellite receiver to your Dual-Deck VCR using the VIDEO and AUDIO IN connections on the Dual-Deck VCR front panel.

To watch the input from this other video equipment, set the channel to '00'. You may do this manually by entering '00' or by programming it into channel memory (see Setting Antenna and Channel Memory, pages 17 and 35). To record this input, press the REC button.

To make a timer recording from other video equipment, set the Channel in the Timer Record menu to '00'. The word AUX will appear on the On-Screen Display in place of the channel number).

To view, you can also use the **VIEW** button to select AUX input.

Audio Connections

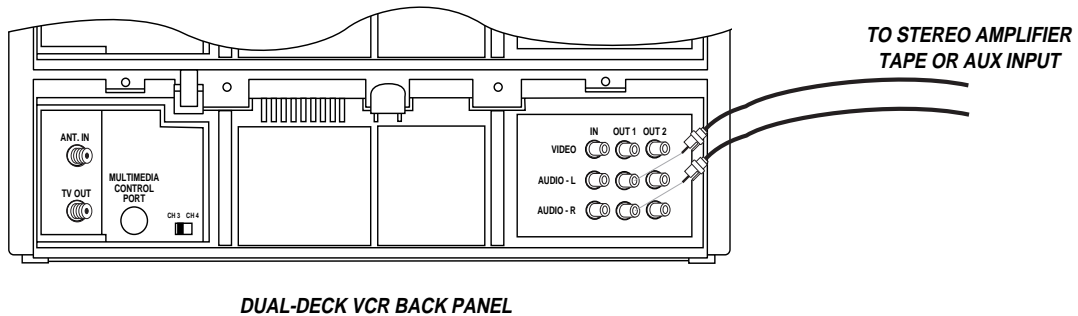

Listening to TV and VCR Audio on your Stereo System

You can connect your Dual-Deck VCR to your stereo system and hear your tapes and those TV programs that are broadcast with MTS Stereo Sound through your stereo speakers. Or, if you have a stereo TV with separate audio input jacks, you can connect the Dual-Deck VCR audio output to your TV and enjoy stereo sound.

1. Connect AUDIO OUT connections on your Dual-Deck VCR back panel to an audio input connection (VCR, auxiliary, tape) on your stereo receiver.
2. Set the TUNER AUDIO to STEREO in the Features menu.
3. On your stereo receiver, select the appropriate input (TAPE or AUX).

Now turn on your Dual-Deck VCR, your TV and your stereo to enjoy full stereo sound with your TV programs and prerecorded movies.

Computer Control Port

Control Your Dual-Deck from Your Computer

Your VCR has a multimedia control port that will allow you to control your Dual-Deck from your IBM or compatible PC (personal computer). This requires an optional hardware interface and software package which is available directly from Go-Video. Complete connection and operating instructions are included in that package. For additional information, please contact our customer service staff at 602-922-0896 (Mon. thru Fri., 8 am-4 pm MST) or send your inquiry via E-Mail (custsvc@govideo.com).



Care of Your Dual-Deck VCR

APPENDIX

A

Placement of Your Dual-Deck VCR

- Place your Dual-Deck VCR within three feet, (to use the supplied cable) but not on top of your TV.
- Place your Dual-Deck VCR in a horizontal position only.
- Do not place your Dual-Deck VCR in extremely hot, cold, humid or dusty places. See 'Environment' in the Technical Specifications section of this Guide for specifications.
- Do not place your Dual-Deck VCR near appliances with electric motors.
- Do not put anything on top of your Dual-Deck VCR. Keep liquids and food away from your Dual-Deck VCR.

Cleaning the Dual-Deck VCR Cabinet

Dust the surface using a soft cloth. Use the dusting attachment of your vacuum occasionally to remove dust from the ventilation holes on the side.

Cleaning the Video Heads

Your new Go-Video Dual-Deck VCR features a built-in video head cleaner, and was designed and engineered to give you many years of trouble-free operation. However careful maintenance of your Dual-Deck VCR's video heads will still be required to assure you of continued clear video image quality.

Video tape naturally degrades over time and with use. When you play a video tape on your VCR, it deposits small amounts of dirt and oxide (a chemical used in the manufacture of video tapes,) on your VCR's video tape heads. Your Dual-Deck VCR's Automatic Head

Cleaner will catch normal residue, but with heavy VCR use, or the playing of old, well-used or damaged video tapes, the accumulation of dirt over time will cause blurs or streaks in the video and video copy image. If left unchecked this dirt build-up can also eventually degrade or even ruin the video tape heads in your Dual-Deck VCR.

To avoid unnecessary repair service charges and maintain your Dual-Deck VCR's quality video image and copy performance, we recommend that you:

- Use only high-quality video tapes.
- Periodically clean the Dual-Deck's video heads at home with a quality 'wet', non-abrasive head-cleaning tape. (Tape head cleaners look like blank tapes. Wet head-cleaning tapes require that you add a liquid cleaning agent before you insert them into your VCR. Dry head-cleaning tapes are abrasive and may cause wear on heads.)
- With heavy rental tape use, you should consider scheduling an annual professional video head-cleaning (and replacement of the Dual-Deck's Automatic Head Cleaner) at your local authorized Go-Video service center.

NOTE:

***DO NOT** attempt to open your Dual-Deck VCR and clean the video heads yourself. Cleaning by any other means than a head-cleaning tape or trained professional will void your warranty*

Care of Videotapes

Do not expose tapes to direct sunlight, extreme heat or extreme cold. Do not disassemble any cassette. Do not touch the tape. Rewind tapes after use and store in protective cases. Remove the record safety tab to prevent recording over previous recordings.

Humidity Requirements

If your Dual-Deck VCR is suddenly moved from a cold to a warm place, moisture may form inside the unit. Before operating, allow at least 2 hours after plugging in the power cord for your Dual-Deck VCR to dry completely. Failure to do so may cause damage to your Dual-Deck VCR and the tape. See 'Environment' in the Technical Specifications section of this Guide for specifications.

Service and Warranty

Never open your Dual-Deck VCR cabinet or touch the inside parts. To do so is dangerous and may cause damage. Do not try to disassemble your Dual-Deck VCR - there are no user-serviceable parts inside.

Servicing of your Dual-Deck VCR should be done by an authorized service center. For service information, see the Customer Service and Warranty section of this guide, on page 71.

Energy Conservation

Save energy. If you will not be using your Dual-Deck VCR for a long period of time, unplug the electrical cord.

Shipping Your Dual-Deck VCR

Carefully pack your Dual-Deck VCR in the original packing materials and carton for shipping.







Glossary

ACTIVE DECK	The deck you have control of. To see which deck that is, look at the LEDs on the front panel of the VCR. Use the Deck Select key to control which deck is active. Green = Deck One and Red = Deck Two.
ALWAYS	A Timer Recording Event which starts every day of the week (Sunday - Saturday).
AMERICHROME COPY	Special circuitry which gives particularly high quality tape duplication. This is also called HQ Copy.
ATR	Auto tracking. Automatically adjusts the tracking for better picture quality. Pressing the PLAY key for 1.5 seconds initiates this feature.
AUDIO COPY INSERT	The ability to record new audio from the audio input jacks on the front panel when copying a tape.
AUTO	A preset automatic feature.
CATV	Cable television channel assignments.
CH MEMORY	During Auto Programming, in the Tuner Setup menu, the VCR selects the channels it can tune in, to add to the channel list used.
CLEAR	A button on the remote control which allows you to clear programming entries in the Timer Recording menu. It also resets the counter to zero for the active deck.
CHANNEL	Two buttons on the remote control and on the front panel which allow you to change to the next higher or next lower channel. If you use these buttons, the VCR will only stop at the channels you have programmed into Channel Memory in the Tuner Setup menu.
COUNTER	A display that describes the relative position of the tape in hours, minutes and seconds.
COPY TAPE	A key that initiates the duplicating of a tape in Deck One to a tape in Deck Two.
CTR	The counter key on the remote control.

DAILY	A Timer Recording Event which starts every weekday (Monday - Friday).
EVENT	A particular television program which is programmed to be recorded in the Timer Recording menu.
FF	Button on the remote control and on the front panel which will fast forward your tape. Press while the active deck is stopped to fast forward the tape. Press while a tape is playing to fast forward while viewing the picture. Press again while a tape is playing to speed up picture scan.
HI-FI	This indicator on the front panel display will be on when a tape with Hi-Fi Audio is playing (if Hi-Fi Audio is turned on - Deck One or Deck Two menus).
HQ COPY	Synchronizes the decks for optimum copying quality.
INDEX	A button on the remote control which allows you to begin an Index Scan or an Index Search. This can be done either when the deck is playing or is stopped. If you press this button during record an index mark will be placed on the tape. An Index Mark is also automatically placed on a tape every time you begin recording from stop or sync edit.
LCV	Last Channel Viewed. If you have a certain channel you want to come back to easily, enter it using the numerical keys. Then you can look at other channels and easily return to this channel by pressing this button on the remote control.
LOOP PLAY	You can start a tape in either deck and when it finishes playing, a tape in the other deck automatically starts playing; when that tape finishes, the tape in the first deck will start playing and so on. See Playback Mode in the Features menu.
LOOP RECORD	In Loop Record, the deck will record until it reaches the end of the tape, then rewind automatically and begin recording again.
MENU	Press this button on the remote control to enter, save and exit the On-Screen Menu System.
MUTE	Press this button on the remote control to turn off the audio (sound). Press again to turn the audio back on. This will not effect recording.
OSD	A button on the remote control which will manually summon the On-Screen Display. Press again to turn the display off. Press again to show OSD with date and time information. Refer to the Setup menu for programming whether this display automatically comes on or not.

- OTR** One Touch Recording. Each time you press REC after the first time, you add 30 minutes to the record time. For Loop Recording on the same tape (see page 22), press until you see 9 min. 30 sec. on front panel display; then press once more.
- PAUSE** Press this button to temporarily stop a tape while playing (still) or recording (pause). If you leave Pause on for 5 minutes, the VCR will automatically begin to play to prevent tape damage.
- PLAY** Press to play the tape in the active deck. Press and hold 1.5 seconds for ATR.
- POWER** Press on either the remote control or the front panel of the VCR to turn your Dual-Deck VCR on and off. The indicator light is on when the VCR is on and off when the VCR is off. If the POWER key is pressed while timer recording, copying a tape or rewinding, the power light will blink. This indicates that the VCR is in a power-off mode and that when the current function is complete, the VCR will automatically turn off.
- RECORD SAFETY TAB** VHS tapes have a record safety tabs to protect you from accidentally recording over your tapes. You break this tab off to prohibit recording. If you later wish to record on that tape, you can put a small piece of tape over the opening.
- REW** Press this button on the remote control while the active deck is stopped to rewind the tape. Press while the tape is playing to rewind while viewing the picture. Press again while a tape is playing to speed up picture rewind.
- SAP** Secondary Audio Program. This indicator on the front panel will be on if the TV program being broadcast has a Secondary Audio Program signal. This audio can be selected via the tuner audio selection in the Tuner Setup menu.
- SEQUENTIAL PLAY** You can start a tape in Deck One and when it finishes playing, a tape in Deck Two will automatically play. See Playback Mode in the Features menu.
- SLOW** Pressing these buttons slows the speed the tape is playing. Successive pressing of the  key on the remote control steps up the speed of the tape. Successive pressing of the  key on the remote control slows down the speed of the tape. Press PLAY to resume normal speed.
- SP, LP, EP** This indicator on the front panel display shows the tape speed for the selected deck. If you are playing a tape, the tape speed is the speed at which the tape was recorded. If you are recording, you can set the tape speed - see Record Speed in the Deck Two menu.

STOP/EJECT	Press this button on the remote control to stop the tape in the active deck. Press again to eject a stopped tape.
TRACKING	Occasionally, when you play a tape that was recorded on a different VCR or camcorder, white streaks appear if the recorded tracks do not align precisely with the playback heads on the VCR. Pressing the Tracking buttons on the remote control allows you to manually adjust the tracking while playing a tape.
TUNER	Device used to receive signals coming into your television which selects the one channel you want to watch from all the different channels which you have available. The Dual-Deck VCR has a 181 channel tuner. See pages 17 and 35 for a detailed explanation.
TV/VCR	Press to switch control of the picture between the TV and the VCR. This is the antenna switch. When set to TV, the antenna signal goes directly to the TV bypassing the VCR; when set to VCR, the antenna signal goes through the VCR. When the VCR power is off, it is the same as TV mode.
VIEW	The signal chosen to be seen on the TV or monitor (Deck One, Deck Two, Tuner, AUX).
VCR	This indicator will be on when the VCR is in VCR mode and off when the VCR is in TV mode.
WEEKLY	Weekly Timer Recording Event which repeats every seven days at the same time.
ZERO RETURN	From stop, press this button and the currently active deck will forward or return to counter time (00:00:00) and stop.



Help - Commonly Asked Questions

APPENDIX

C

"I'm not getting a picture."

Make sure that the TV/VCR selection is set to VCR. (Is the VCR icon on the front panel display on?) You can select TV/VCR from the remote control or use the button on the front panel of the VCR. Also make sure your TV is set to the same channel (3 or 4) as the switch on the back of your VCR.

If using Audio/Video out jack on the VCR, make sure the TV is set to Line/AUX/AV in.

"The picture is bad."

If the picture is bad while watching the VCR and your TV is set to channel 3 or 4 (see above), try adjusting the fine tuning on your TV. Or try changing the output channel of the VCR (if set to 3 change to 4, and if set to 4 change to 3). Then make sure your TV is set to the same channel.

If the picture is bad while watching TV on a channel (as opposed to watching the VCR with the TV set on channel 3 or 4), make sure the VCR is in TV mode.

If the picture is bad while playing a tape, try adjusting the tracking control. Use the ATR (Automatic Tracking) button or the TRACKING + - keys on the remote control. Or, the video heads might be dirty; try cleaning the heads with a non-abrasive head cleaning tape. Remember, you can always check to make sure the tape is OK by playing it in the other deck.

See the 'Poor Video Quality' troubleshooting flow chart on page 62.

"I can't record from my TV."

When the VCR is in VCR mode and your TV is set to channel 3 or 4, you should be able to view the desired channel on your TV. If you have a cable converter box, make sure the VCR is tuned to the cable converter box output channel.

"I can't timer record."

Make sure that your Dual-Deck VCR's clock is set to the proper time. Double check the AM/PM setting. If you have a cable converter box, make sure the timer record channel setting in the TIMER RECORD menu is set to the cable converter box output channel (2, 3 or 4) and the cable box is set to the channel you want to record.

"My remote control isn't working."

There are several things which could cause your remote control not to function properly. First, make sure you are aiming the remote control directly at the VCR. Make sure there are no obstacles between the remote control and the VCR so the 'beam' is not obstructed. Also, the signal from the remote can be obstructed if a very strong light source, such as sunlight, falls on the front panel of the VCR. Finally, make sure the batteries in your remote control are fresh and installed properly.

"When I use Copy Tape, my tapes are recorded at a speed other than what was set."

In the COPY TAPE menu, check to see if Speed Matching is on. When this feature is on, the recording speed of a copy will be set to the speed of the source tape. If you want to change the speed at which the tape is being copied, turn this feature off.

"When I use Copy Tape or put a tape into record, the tape ejects."

Make sure there is a Record Safety Tab on your tape. If the tab is missing, you can place a small piece of transparent tape over the hole. This will allow you to copy or record onto the tape.

"Sometimes the tape begins to play or rewind when I don't want it to."

This Dual-Deck VCR can automatically play a tape (with no record safety tab in place) whenever you load it, and it will automatically rewind the tape when it reaches the end. AUTO PLAY/REWIND can be turned on or off via the AUTO PLAY/REWIND selection in the SET UP menu.

Also, when EZ COPY in the FEATURES menu is on, both decks will automatically rewind before recording when you start a copy tape procedure. This process can be disabled by pushing the STOP key on Deck Two.

"My On-Screen Display has a message that says ERROR."

This means the VCR has had difficulty with the tape mechanism. To reset, turn the power off and then on again. If this does not clear the error, unplug the VCR from the wall outlet and inspect both tape slots for foreign objects, or jammed or crooked tapes. If this does not help, consult a service center.

"My VCR doesn't work."

A strong static electricity shock or other unforeseen circumstances can cause the control system of your Dual-Deck VCR to lock up. To reset the control system, first unplug the power cord from the wall outlet for 20 seconds and plug it in again. If this doesn't restore all operations to normal, unplug it again for 15 minutes. You will then need to reset the clock (if the clock is still set, you haven't unplugged it long enough). If these steps do not correct the problem, the Dual-Deck VCR must be serviced by an authorized service center.

"Why aren't the Counters moving?"

If the VCR is playing an unrecorded or blank tape, the counter cannot operate. The VCR relies on the control track that is always recorded on to the video tape to provide counter information.

"Why can't I get a Menu or an On-Screen Display?" _____

If the VCR is playing an unrecorded or blank tape, the VCR cannot produce on-screen data to be displayed. Stopping the tape, or recording on it, will allow the on-screen display to resume.

See the 'No Menu is Visible' troubleshooting flow chart on page 61.

"Why do I get a blue screen?" _____

If the VCR's tuner cannot receive a normal synchronized signal, it will put a blue screen in its place. Double check your antenna connections.

"The Power Indicator is blinking." _____

Your Dual-Deck VCR is in Auto Power Off mode. If you press the power button while rewinding a tape, timer recording, One-Touch recording, copying a tape, or using EZ-Copy, your VCR will automatically turn off when that function is completed. Repeatedly pressing the power button will turn Auto Power mode on and off.

"Copy on the Front Panel Display is blinking." _____

Any pause (interruption) in the Copy Tape process will cause this button to blink. See Sync Edit, page 27.

TROUBLESHOOTING

No Menu is Visible

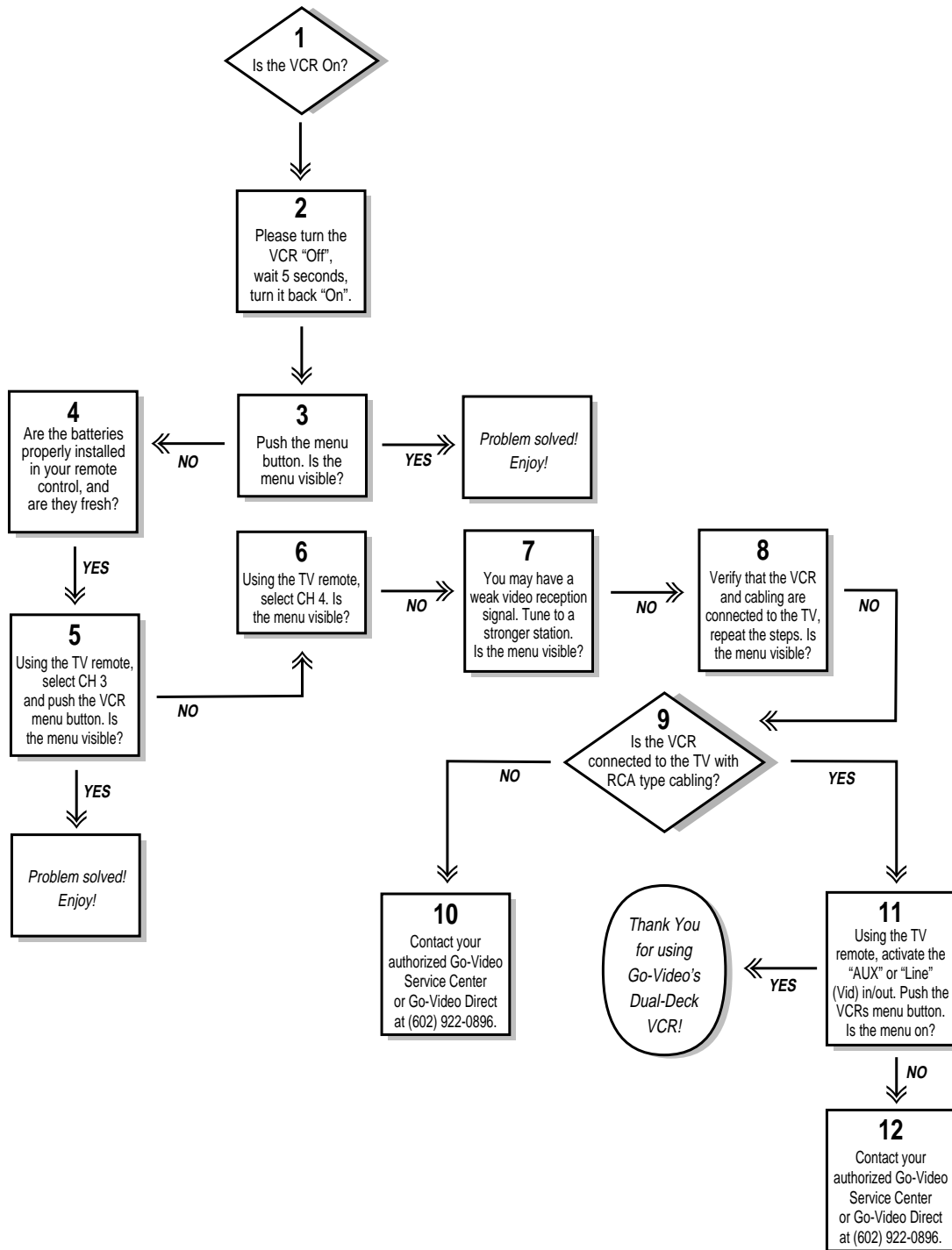

TROUBLESHOOTING

Poor Video Quality

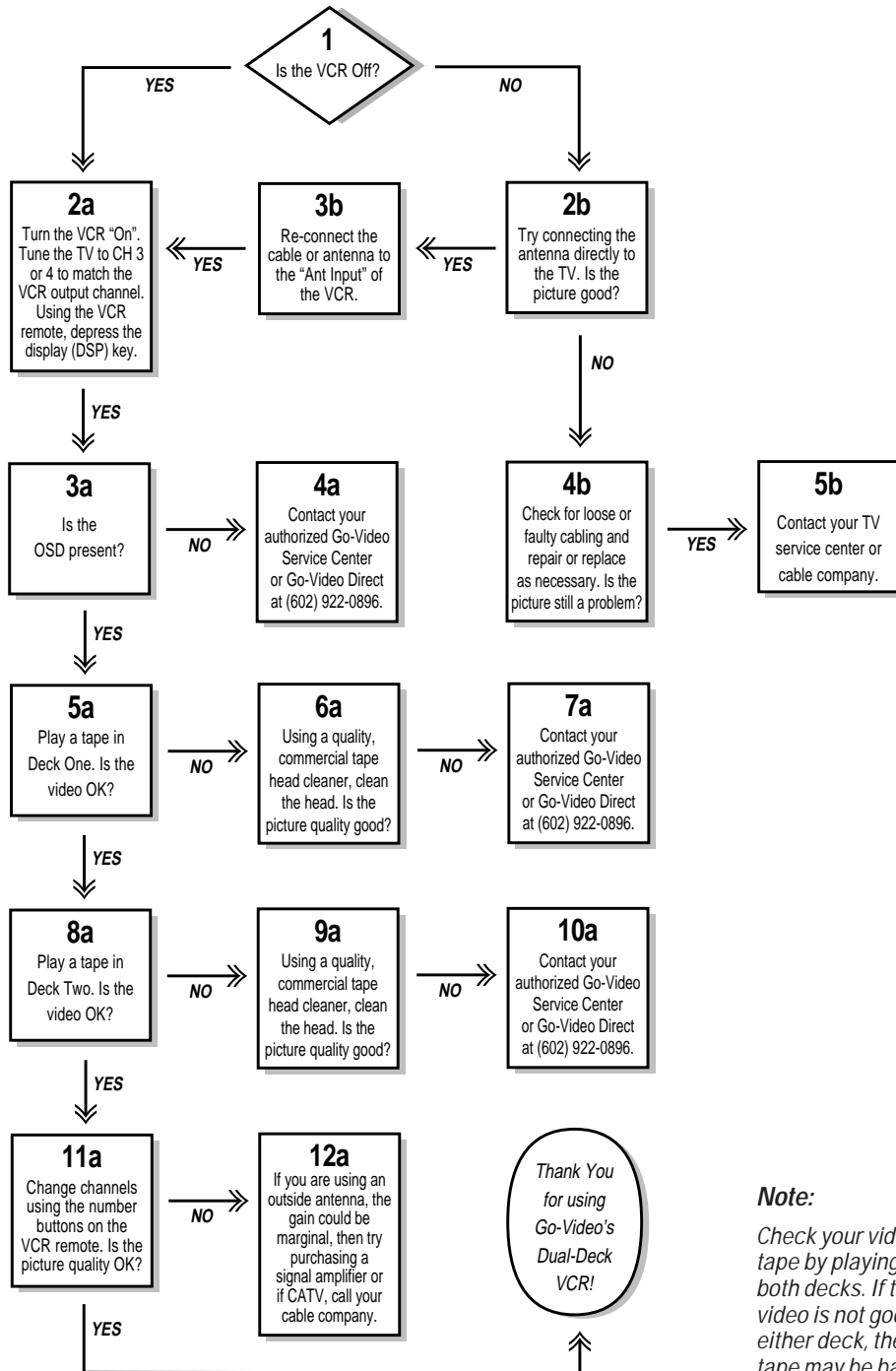

Note:

Check your video tape by playing it on both decks. If the video is not good in either deck, the tape may be bad.

TROUBLESHOOTING

Connecting Your VCR to Your TV, Monitor or Stereo System

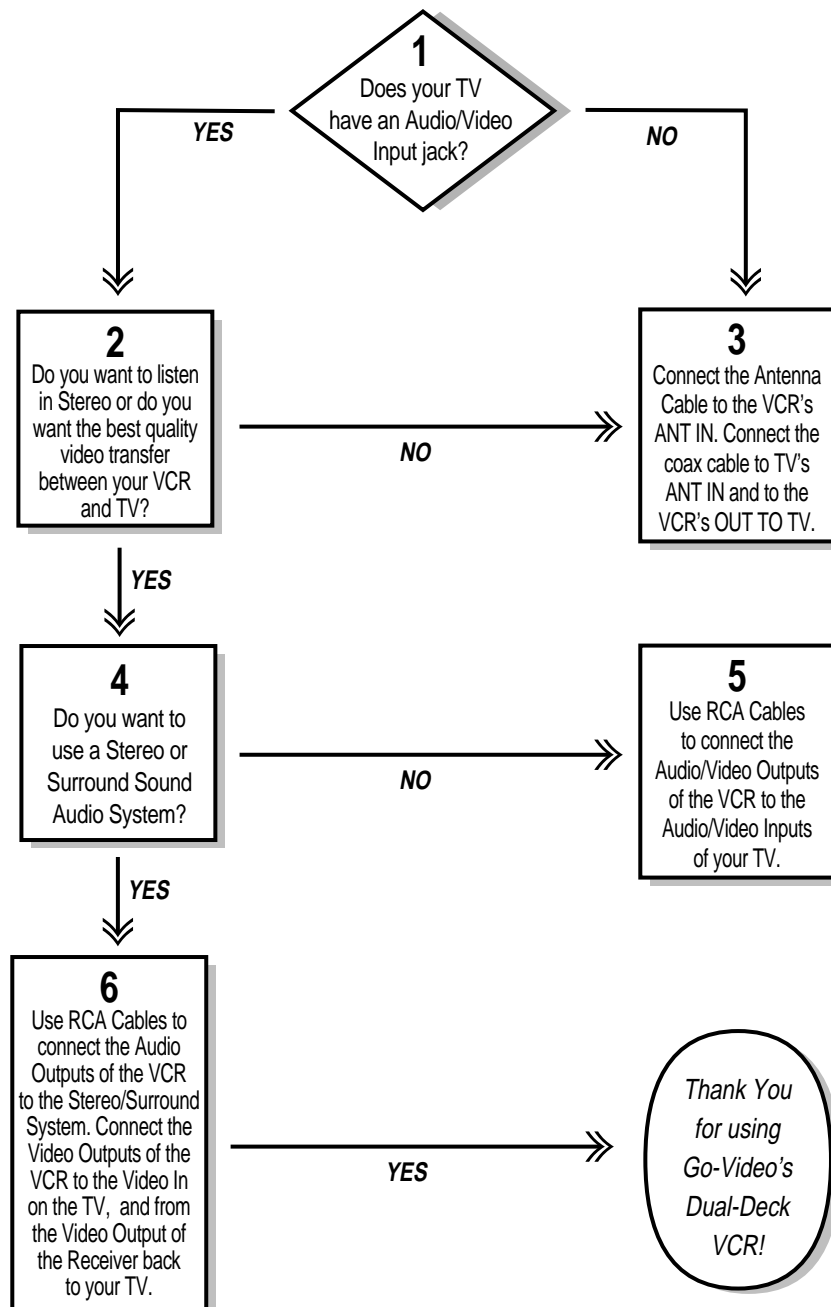





Customer Service Information

APPENDIX

D

Congratulations on your purchase of a Go-Video Dual-Deck VCR.

Record the serial number from the back of your VCR here. Attach your sales receipt and/or a copy of your charge slip for reference.

Serial Number: _____

Purchase Date: _____

Note: *It is important that you register your Dual-Deck VCR with Go-Video, Inc. To register your Dual-Deck VCR, complete the warranty registration card and mail it in.*

Customer Support Services

If you encounter a technical problem with your Dual-Deck VCR and are not able to find your answer in this manual, you are welcome to call our customer support staff at 602-922-0896 or at our E-Mail address (custsvc@govideo.com) on Monday-Friday 8:00 am to 4:00 pm MST.

Often your questions can be answered on the phone when you call. To make this easier, please call only while you are in front of your equipment with it turned on and ready. Also, please have your unit serial number available.

See Dual-Deck Warranty on page 64.

Authorized Go-Video Service Centers

For your convenience, Go-Video has developed an extensive network of Dual-Deck VCR Service Centers across North America. For a list of the Authorized Go-Video Service Centers in your local area, call Go-Video Customer Service at (602) 922-0896.

DUAL-DECK VCR LIMITED WARRANTY

WHO PROVIDES THE LIMITED WARRANTY

During the warranty period, the Go-Video Warranty Administrator will honor Dual-Deck VCR service for 90 days labor, 1 year parts from the original date of consumer purchase. See below for Commercial, Industrial or Educational use coverage. Dual-Deck VCR remote controls are warranted for 90 days from the date of purchase.

WHO IS PROTECTED

This warranty protects the original consumer owner of this Go-Video product.

WHAT IS COVERED AND HOW LONG

This warranty covers internal operating parts and service/labor to repair or replace covered parts in this Go-Video product for 90 days labor, 1 year parts, from the date of purchase, defined as follows: (1) Original Consumer Retail Purchase; (2) First Rental Purchase Agreement; or (3) First Lease Purchase Agreement (the "Warranty Period"). Labor and replacement parts supplied during the Warranty Period are covered only for the remaining portion of the original Warranty Period. The Go-Video Warranty Administrator shall have no liability for service under this warranty if non-OEM (Original Equipment Manufacturer) replacement parts are used in the repair of your Go-Video product.

WHAT THE OWNER MUST DO IF SERVICE IS REQUIRED

If service under this warranty is required, contact the Go-Video Warranty Administrator at (602) 922-0896.

OTHER WARRANTY COVERAGE

Commercial, Industrial or Educational use has the same warranty coverage as stated in this warranty.

WHAT ARE THE EXCEPTIONS

This warranty does **not** cover: (1) Normal maintenance service, such as video head cleaning. (2) Damage from misuse, abuse, neglect or accident, natural disasters or Acts of God. (3) Cabinetry, decorative parts, A/C adapters, knobs or buttons. (4) The foreign country use of this product. (5) Go-Video product which has been electronically or mechanically modified in any way or incorporated into other products. (6) Installation and set-up service adjustments. (7) Owner instruction. Your Owner's Guide provides information regarding operating instructions and user controls. For additional information, contact your authorized Go-Video dealer.

Go-Video is not responsible for any shipping, handling or insurance charges.

This Exclusive Limited Warranty excludes all incidental and consequential damages. Some states do not allow the exclusion of incidental and consequential damages, so the above exclusion may not apply to you.

ALL IMPLIED WARRANTIES, INCLUDING IMPLIED WARRANTIES OF MERCHANTABILITY AND FITNESS FOR A PARTICULAR PURPOSE ARE LIMITED IN DURATION TO THE DURATION OF THIS WARRANTY PERIOD. Some states do not allow limitations on how long an implied warranty lasts, so the above limitation may not apply to you.

This Exclusive Limited Warranty gives you specific legal rights and you may also have other rights which vary from state to state.

For questions contact:

GO-VIDEO WARRANTY ADMINISTRATOR

7835 EAST McCLAIN DRIVE, SCOTTSDALE, AZ 85260-1732
(602) 922-0896 • E-Mail: custsvc@govideo.com



Technical Specifications

VIDEO SYSTEM:	1/2" VHS system, rotary head helical scanning; chrominance: converted sub-carrier phase shift recording; luminance: FM azimuth recording
TELEVISION SYSTEM:	NTSC-type color signal EIA standard (525 lines, 60 fields)
AUDIO TRACK:	Normal: 1 track, Hi-Fi: 2 track
TAPE WIDTH:	12.7 mm, 1/2 inch
TAPE SPEED:	SP: 33.35 mm/s, EP: 11.12 mm/s
PLAY/RECORD TIME:	T-200 tape at EP mode: Up to 10 hours
FF/REW TIME:	T-120 tape: 3 minutes 15 seconds
HEADS:	Video: Dual azimuth, four head Audio: 1 stationary head, Mono; 2 rotating heads, Hi-Fi Control: 1 stationary head Erase: 1 full track, 1 audio track
VIDEO:	Input: 75 ohms, unbalanced 1 V P-P Output: 75 ohms, unbalanced 1 V P-P
Horiz Res:	Monochrome, more than 220 lines (SP)
S/N Ratio:	RF = 75 dB; Video = chrominance 42 dB, luminance 47 dB; Audio = 38 dB weighted (SP)
AUDIO:	Input: AUDIO IN (RCA) -8 dbu, 47K ohms Output: AUDIO OUT (RCA) -8 dbu 1.5K ohm
TV Tuner:	181 channel frequency synthesized. VHF input Ch 2 - Ch 13. UHF input Ch 14 - Ch 69. VHF & UHF one input. Cable Ch 5A, A-5 through A-1, A-I, J through W+58, W+59 through W+84. 75 ohm unbalanced.

WOW & FLUTTER:	Less than .005% (weighted R/P [SP])
ANTENNA OUTPUT:	75 ohm, unbalanced F-type
RF MODULATION:	Channel 3 or 4
FREQUENCY RESPONSE:	20-20,000 Hz (Hi-Fi)
POWER REQUIREMENT:	120V AC, 60 Hz, 29 watts
CLOCK BACKUP TIME:	30 seconds
ENVIRONMENT:	35% - 80% relative humidity
WEIGHT/DIMENSIONS:	8 kg (17.6 lbs) 370 mm x 193 mm x 285 mm (14.6" x 7.6" x 11.2")



Dual-Deck Index



Antenna Setting	17, 37, 43-45
Assembly Editing	26-27
Audio Connections	53
Auto Play/Rewind	6, 30
Auto Power Off	6
Auto Program	37
Automatic Features	6
Automatic Show Finder	28
AUX	52-53
AUX Input	32
Cable Converter Box Hookup	47
Cable Hookup, Basic	46
Camcorder, Connecting	52
Care of Dual-Deck VCR	55
Cleaning Your VCR	55
Clock, Setting	15, 30
Clock Menu	15, 30
Connecting the Dual-Deck VCR	42
Connecting Video Equipment	52
Copy Audio Insert	27, 33
Copying a Tape	21
Date, Setting	15, 30
Date/Time Stamp	26, 31
Deck One Menu	39
Deck Two Menu	39
Display, On-Screen	14, 29
Double-Speed Playback	8, 11, 19
Editing, Assembly	26-27
EZ Copy	34
Fast Forward	8, 11, 19
Features Menu	33
Frame Advance	13, 18
Front Panel Display	9
Help	63-69
Hi-Fi Audio	41
Hookup, Cable Converter Box	47
Hookup, VHF and UHF Antennas	45
Hookup, Other Video Equipment	52

Hookup, Cable	46
Hookup, Basic Antenna	17, 43-45
Hookup, Basic Cable	46
HQ Copy	33
Index Marks	11, 28
Index Search	11, 28
Index Scan	11, 28
Jet Search	8, 11, 19
Language Menu	15, 36
Laser Disc Player	52
Loop Play	20
Loop Record	22, 34-35
Menu System	29-41
On-Screen Display	14, 29, 30
On-Screen Menu System	14, 29, 30
One Touch Recording (OTR)	9, 22
Playback Mode	34
Playing a Tape	18
Record Mode	34-35
Record Source	41
Recording, Timer	23
Recording from TV	22
Recording Speed	21
Remote Control	11
Reverse Picture Search	8, 11, 19
Reverse Jet Search	8, 11, 19
Safety	inside front cover, i, ii
Satellite Receiver	52
Second TV View	31, 51
Sequential Play	20
Service	71
Skip Search	13, 27
Slow Motion	13, 18
Speed Matching	33
Sync Edit	27
Tape Length	21, 25, 39
Tape Counter	27
Technical Specifications	73
Time, Setting	15, 30
Timer Record Menu	40
Timer Record Event	23, 40
Tracking	20
Troubleshooting	63-69
Tuner Audio	37-38
Tuner/Setup Menu	37-38
VHS Index Search System	28
Video Camera	52
Warranty	72
Zero Return	12



7835 East McClain Drive
Scottsdale, Arizona 85260-1732
USA

(602) 998-3400
E-Mail: custsvc@govideo.com

Free Manuals Download Website

<http://myh66.com>

<http://usermanuals.us>

<http://www.somanuals.com>

<http://www.4manuals.cc>

<http://www.manual-lib.com>

<http://www.404manual.com>

<http://www.luxmanual.com>

<http://aubethermostatmanual.com>

Golf course search by state

<http://golfingnear.com>

Email search by domain

<http://emailbydomain.com>

Auto manuals search

<http://auto.somanuals.com>

TV manuals search

<http://tv.somanuals.com>