

GO VIDEO

SONIC|blue™

DVP745 User's Manual

DVD Player



Content

Introduction

■ Safety Precautions	2
■ Important Safety Instructions	3
■ Caution	5
■ Features	6
■ Front Panel and Rear Panel Illustration	7
■ VFD Illustration	8
■ Remote Control	9

Connections

■ Connecting to a TV set	10
■ Connecting to an AV Amplifier with 2 Channel Analog Audio Input	11
■ Connecting to an AV Amplifier with Digital Audio Input	12
■ Connecting to headphones	13

Basic Playback

■ Basic Operation	14
-------------------------	----

Advanced Features

■ Modes and Features Setup	15
■ Remote Control Operation	22
■ MP3 Playback	33

Other

■ Troubleshooting	34
■ Specifications	35
■ Remote Control Preparation	36

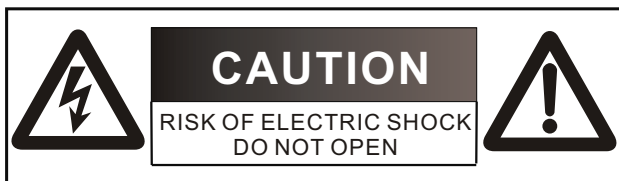

THE LIGHTNING FLASH WITH ARROW-HEAD SYMBOL WITHIN AN EQUILATERAL TRIANGLE IS INTENDED TO ALERT THE USER TO THE PRESENCE OF UNINSULATED "DANGEROUS VOLTAGE" WITHIN THE UNIT'S CABINET THAT MAY BE OF SUFFICIENT MAGNITUDE TO CONSTITUTE A RISK OF ELECTRIC SHOCK TO PERSONS.



THE EXCLAMATION POINT WITHIN AN EQUILATERAL TRIANGLE IS INTENDED TO ALERT THE USER TO THE PRESENCE OF IMPORTANT OPERATING AND MAINTENANCE (SERVICING) INSTRUCTIONS IN THE MANUAL ACCOMPANYING THE UNIT.

WARNING:

TO PREVENT FIRE OR ELECTRIC SHOCK, DO NOT EXPOSE THE UNIT TO RAIN OR MOISTURE. NEVER ATTEMPT TO OPEN THE CABINET, DANGEROUS HIGH VOLTAGES ARE PRESENT IN THE UNIT. REFER SERVICING TO QUALIFIED SERVICE PERSONNEL.

CAUTION:

TO PREVENT ELECTRIC SHOCKS, MATCH WIDE-BLADE PLUG WITH WIDE SLOT AND FULLY INSERT. THE APPARATUS SHALL NOT BE EXPOSED TO WATER AND NO OBJECTS FILLED WITH LIQUIDS SUCH AS VASES SHALL BE PLACED ON THE APPARATUS.

CAUTION:

THE UNIT EMPLOYS A LASER SYSTEM. TO ENSURE THE PROPER USE OF THE UNIT, READ THIS MANUAL CAREFULLY AND KEEP IT FOR FUTURE REFERENCE.

IF THE UNIT REQUIRES SERVICING, CONTACT THE SELLER OR OUR SERVICE CENTER-SEE "TROUBLESHOOTING".

TO PREVENT DIRECT EXPOSURE TO THE LASER RADIATION, DO NOT OPEN THE CABINET. VISIBLE LASER MAY RADIATE WHEN THE CABINET IS OPENED OR THE INTERLOCKS ARE DEFEATED. DO NOT STARE INTO THE LASER BEAMS.

CAUTION:

THE DVD VIDEO PLAYER IS A CLASS 1 LASER PRODUCT. USE OF CONTROLS OR ADJUSTMENTS OR PERFORMANCE OF PROCEDURES OTHER THAN THOSE SPECIFIED HEREIN MAY RESULT IN HAZARDOUS RADIATION EXPOSURE.

AS THE LASER BEAM USED IN THIS DVD VIDEO PLAYER IS HARMFUL TO THE EYES, DO NOT ATTEMPT TO DISASSEMBLE THE CABINET.

REFER SERVICING TO QUALIFIED PERSONNEL ONLY.

WARNING:

FCC REGULATIONS STATE THAT ANY CHANGE OR MODIFICATION TO THE EQUIPMENT, NOT EXPRESSLY APPROVED BY MAKER OR ITS AUTHORIZED PARTIES, COULD VOID USER'S AUTHORITY TO OPERATE THIS EQUIPMENT.

Remark

PLEASE WRITE DOWN THE MODEL NO. AND SERIAL NO. PRINTED ON THE REAR PANEL.

Model No. _____

Serial No. _____

1. Read Instructions

All the safety and operating instructions should be read before the product is operated.

2. Retain Instructions

The safety and operating instructions should be retained for future reference.

3. Heed Warnings

All warnings on the product and in the operating instructions should be adhered to.

4. Follow Instructions

All operating and use instructions should be followed.

5. Cleaning

Unplug this product from the wall outlet before cleaning. Do not use liquid cleaners or aerosol cleaners. Use a damp cloth for cleaning.

6. Attachments

Do not use attachments not recommended by the product manufacturer as they may cause hazards.

7. Water and Moisture

Do not use this product near water for example, near a bathtub, wash bowl, kitchen sink, or laundry tub; in a wet basement; or near a swimming pool; and the like.

8. Accessories

Do not place this product on an unstable cart, stand, tripod, bracket, or table. The product may fall, causing serious injury to a child or adult, and serious damage to the product. Use only with a cart, stand, tripod, bracket, or table recommended by the manufacturer, or sold with the product. Any mounting of the product should follow the manufacturer's instructions, and should use a mounting accessory recommended by the manufacturer.

9. Portable Cart Warning

A product and cart combination should be moved with care. Quick stops, excessive force, and uneven surfaces may cause the product and cart combination to overturn.



(Symbol provided by RETAC)

10. Ventilation

Slots and openings in the cabinet are provided for ventilation and to ensure reliable operation of the product and to protect it from overheating, and these openings must not be blocked or covered. The openings should never be blocked by placing the product on a bed, sofa, rug, or other similar surface. This product should not be placed in a built-in installation such as a bookcase or rack unless proper ventilation is provided or the manufacturer's instructions have been adhered to.

11. Power Sources

This product should be operated only from the type of power source indicated on the marking label. If you are not sure of the type of power supply to your home, consult your product dealer or local power company. For products intended to operate from battery power, or other sources, refer to the operating instructions.

12. Grounding or Polarization

This product may be equipped with a polarized alternating current line plug (a plug having one blade wider than the other). This plug will fit into the power outlet only one way. This is a safety feature. If you are unable to insert the plug fully into the outlet, try reversing the plug. If the plug should still fail to fit, contact your electrician to replace your obsolete outlet. Do not defeat the safety purpose of the polarized plug.

13. Power Cord Protection

Power supply cords should be routed so that they are not likely to be walked on or pinched by items placed upon or against them, paying particular attention to cords at plugs, convenience receptacles, and the point where they exit from the product.

14. Protective Attachment Plug

The product is equipped with an attachment plug having overload protection. This is a safety feature. See Instruction Manual for replacement or resetting of protective device. If replacement of the plug is required, be sure the service technician has used a replacement plug specified by the manufacturer that has the same overload protection as the original plug.

15. Outdoor Antenna Grounding

If an outside antenna or cable system is connected to the product, be sure the antenna or cable system is grounded so as to provide some protection against voltage surges and built-up static charges. Article 810 of the National Electrical Code, ANSI/NFPA 70, provides information with regard to proper grounding of the mast and supporting structure, grounding of the lead-in wire to an antenna discharge unit, size of grounding conductors, location of antenna discharge unit, connection to grounding electrodes, and requirements for the grounding electrode. See figure below.

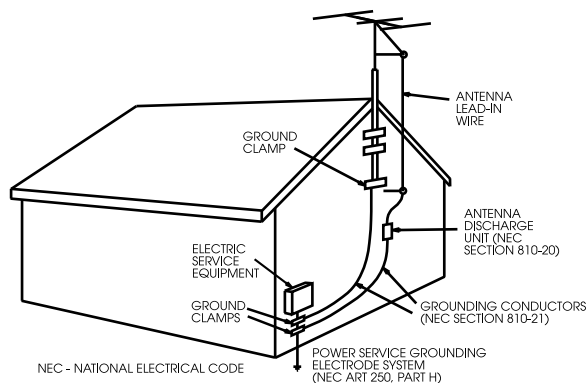

16. Lightning

For added protection for this product during a lightning storm, or when it is left unattended and unused for long periods of time, unplug it from the wall outlet and disconnect the antenna or cable system. This will prevent damage to the product due to lightning and power lines surges.

17. Power Lines

An outside antenna system should not be located in the vicinity of overhead power lines or other electric light or power circuits, or where it can fall into such power lines or circuits. When installing an outside antenna system, extreme care should be taken to keep from touching such power lines or circuits as contact with them might be fatal.

18. Overloading

Do not overload wall outlets, extension cords, or integral convenience receptacles as this can result in a risk of fire or electric shock.

19. Object and Liquid Entry

Never push objects of any kind into this product through openings as they may touch dangerous voltage points or short-out parts that could result in a fire or electric shock. Never spill liquid of any kind on the product.

20. Servicing

Do not attempt to service this product yourself as opening or removing covers may expose you to dangerous voltage or other hazards. Refer all servicing to qualified service personnel.

21. Damage Requiring Service

Unplug this product from the wall outlet and refer servicing to qualified service personnel under the following conditions:

- A) When the power-supply cord or plug is damaged,
- B) If liquid has been spilled, or objects have fallen into the product,
- C) If the product has been exposed to rain or water,
- D) If the product does not operate normally by following the operating instructions. Adjust only those controls that are covered by the operating instructions as an improper adjustment of other controls may result in damage and will often require extensive work by a qualified technician to restore the product to its normal operation,
- E) If the product has been dropped or damaged in any way, and
- F) When the product exhibits a distinct change in performance this indicates a need for service.

22. Replacement Parts

When replacement parts are required, be sure the service technician has used replacement parts specified by the manufacturer or have the same characteristics as the original part. Unauthorized substitutions may result in fire, electric shock, or other hazards.

23. Safety Check

Upon completion of any service or repairs to this product, ask the service technician to perform safety checks to determine that the product is in proper operating condition.

24. Wall or Ceiling Mounting

The product should be mounted to a wall or ceiling only as recommended by the manufacturer.

25. Heat

The product should be situated away from heat sources such as radiators, heat registers, stoves, or other products (including amplifiers) that produce heat.

- Please use the original box and packing materials for safe transportation of this product.

- It is normal for the cover and rear panel to become warm after the player has been operating for an extended period of time.

- Do not move this product during playback. Doing so may cause damage to the pickup and the disc.

- Press **OPEN/CLOSE** on the front panel or remote to open or close the disc tray. Do not push or touch the tray while it is opening or closing.

- Full compatibility with DVD, SVCD, VCD, CD, and Mp3 on CD-R & CD-RW (finalized)
- Screen saver
- Multiple playback modes: Memory, Program, Search, 10-Second Review
- Dynamic spectrum display and 6 adjustable frequency bands
- Optical and coaxial digital audio outputs
- DOLBY DIGITAL DOWN MIX 2 channel output
- S-video, composite video and component video outputs
- Headphone output

Disc formats supported by this player:



Digital Theatre System



Multi-angle



Dolby Digital



Closed Caption



Audio CDs



Subtitle choices



Video CDs



Audio choices



DVD video

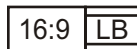

TV aspect ratio modes



Parental Lock

This product incorporates copyright protection technology that is protected by method claims of certain U.S. patents and other intellectual property rights owned by Macrovision Corporation and other rights owners. Use of this copyright protection technology must be authorized by Macrovision Corporation, and is intended for home and other limited viewing uses only unless otherwise authorized by Macrovision Corporation. Reverse engineering or disassembly is prohibited.

Manufactured under license from Dolby Laboratories. "Dolby" and the double-D symbol are trademarks of Dolby Laboratories. Confidential Unpublished Works. © 1992-1997 Dolby Laboratories, Inc. All rights reserved.

Manufactured under license from Digital Theater Systems, Inc. US Pat. No. 5,451,942, 5,956,674, 5,974,380, 5,978,762 and other world-wide patents issued and pending. "DTS" and "DTS Digital Surround" are registered trademarks of Digital Theater Systems, Inc. Copyright 1996, 2000 Digital Theater Systems, Inc. All Rights Reserved.

Front panel and rear panel illustration

Front panel

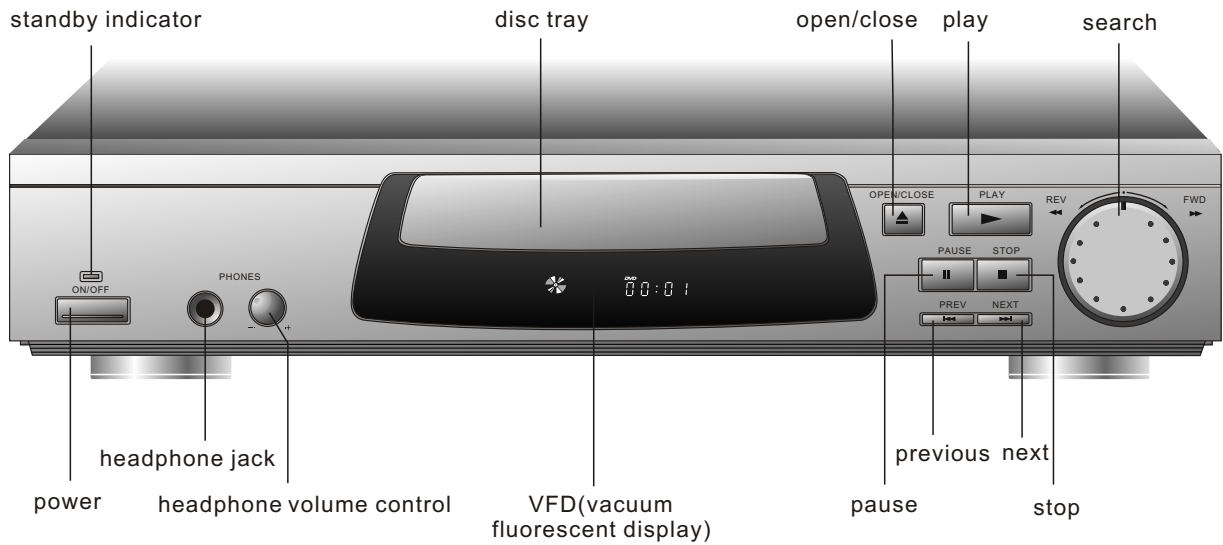

Rear panel

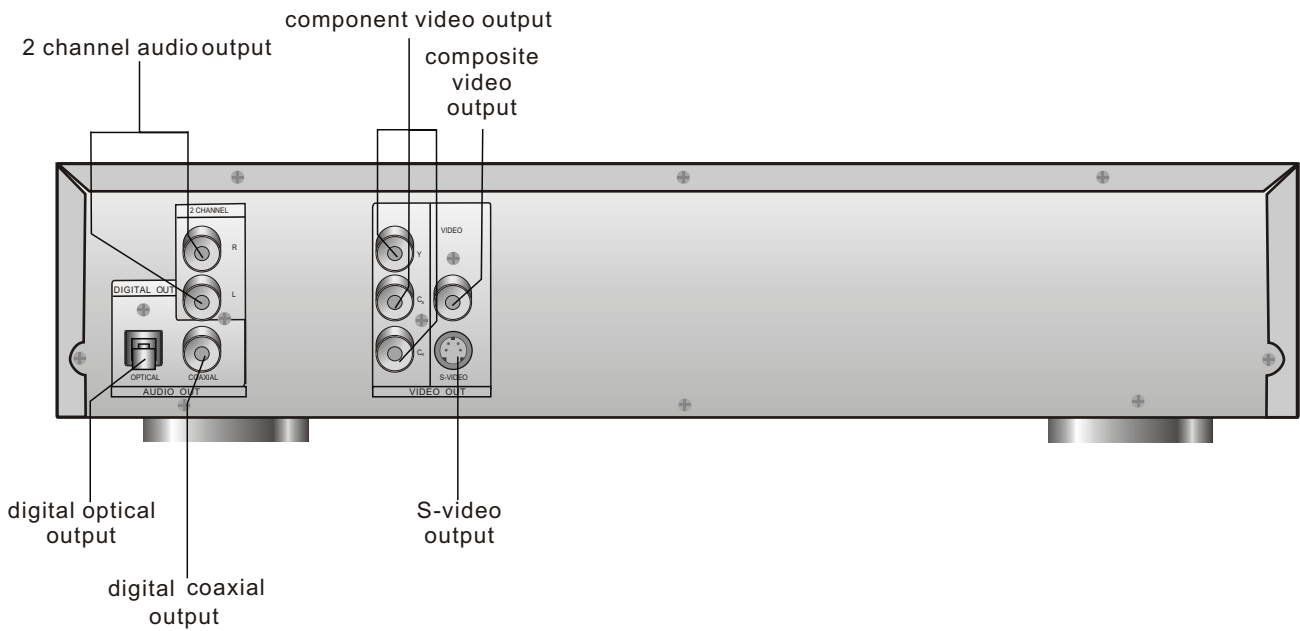

VFD Illustration

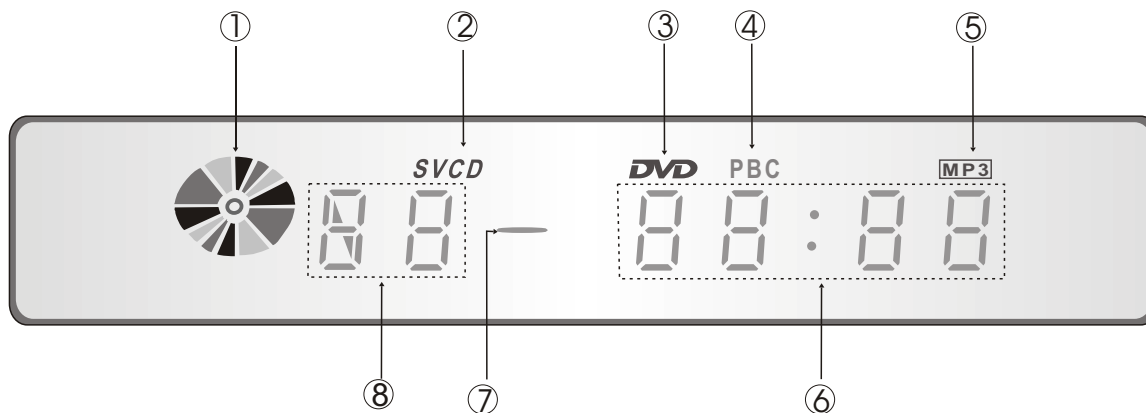

The figure above shows the front panel with all the displays on.

- | | |
|------------------------------------|---|
| ① Play indicator | Graphically displays playback status. |
| ② SVCD-VCD indicator | Lights when a CD, VCD or SVCD disc is loaded. |
| ③ DVD indicator | Lights when a DVD disc is loaded. |
| ④ PBC (playback control indicator) | Lights when a VCD or SVCD menu is displayed.. |
| ⑤ MP3 indicator | Lights when an MP3 disc is loaded. |
| ⑥ Time/Chapter indicator | Indicates the total playing time or chapter number when a DVD disc is loaded. |
| ⑦ CD-VCD-SVCD indicator | Lights when a CD, VCD or SVCD disc is loaded and ⑥ indicates chapter number. |
| ⑧ Track/Title indicator | Indicates the current track number (CD, VCD or SVCD) or title number (DVD). |

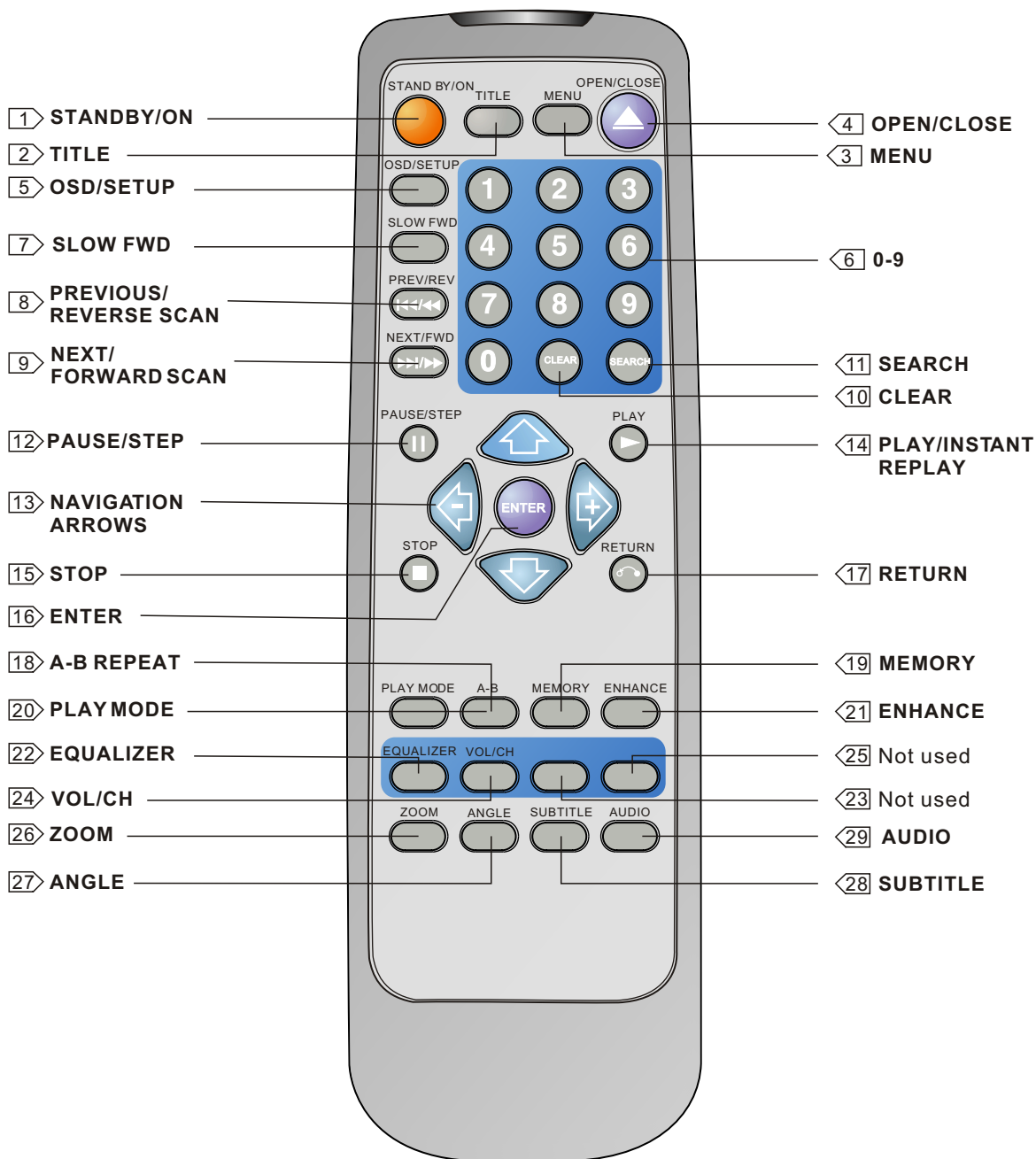

Note: Please note that reference numbers for the remote are described beginning on page 23 of this manual.

Connecting to a TV set

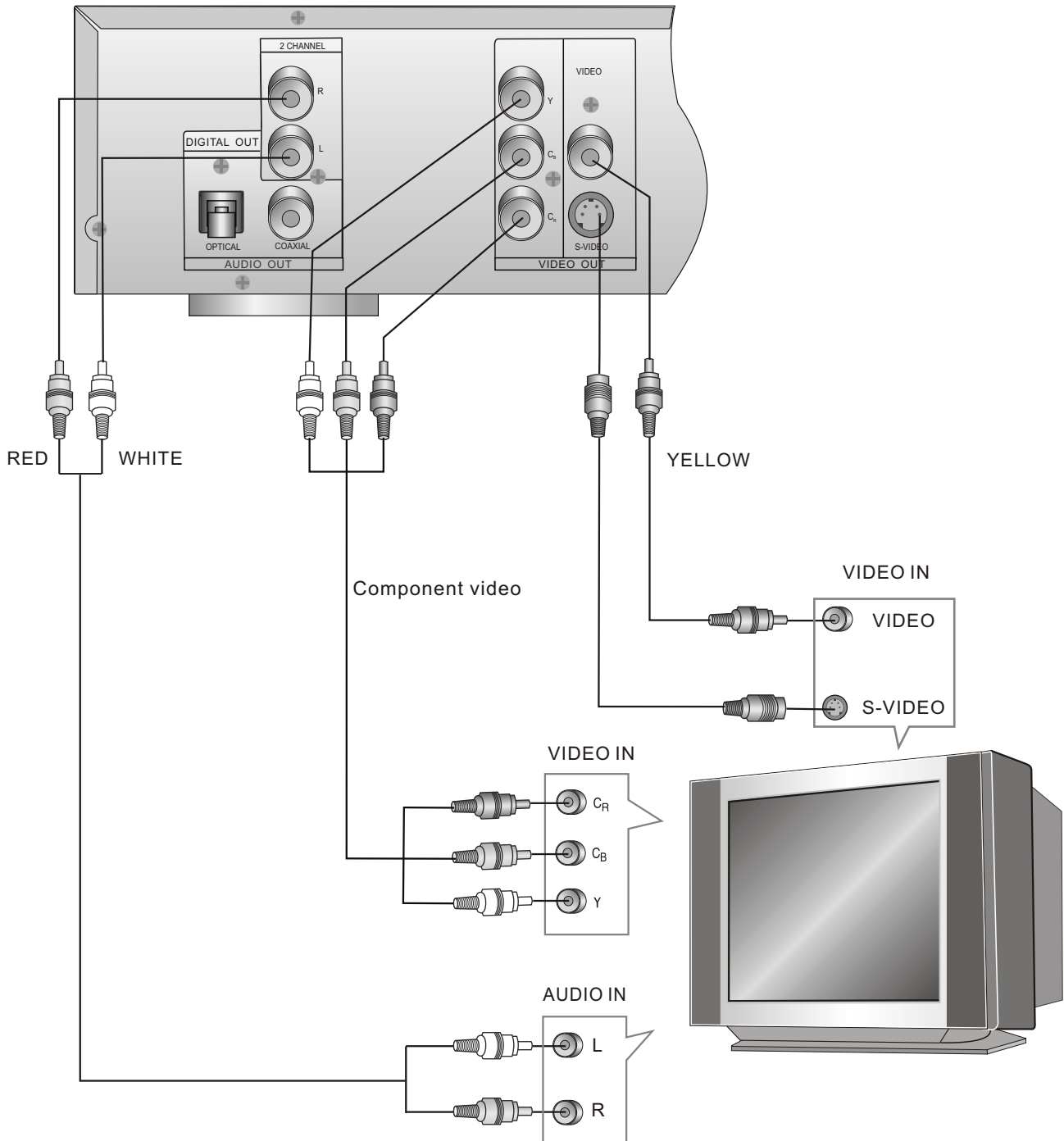

Notes:

There are three ways of connecting the player's AV output to the TV set:

1. S-video cord and audio cable.
2. Composite video cord and audio cable.
3. Component video cord and audio cable.

Connecting to an AV amplifier with 2 channel analog audio input

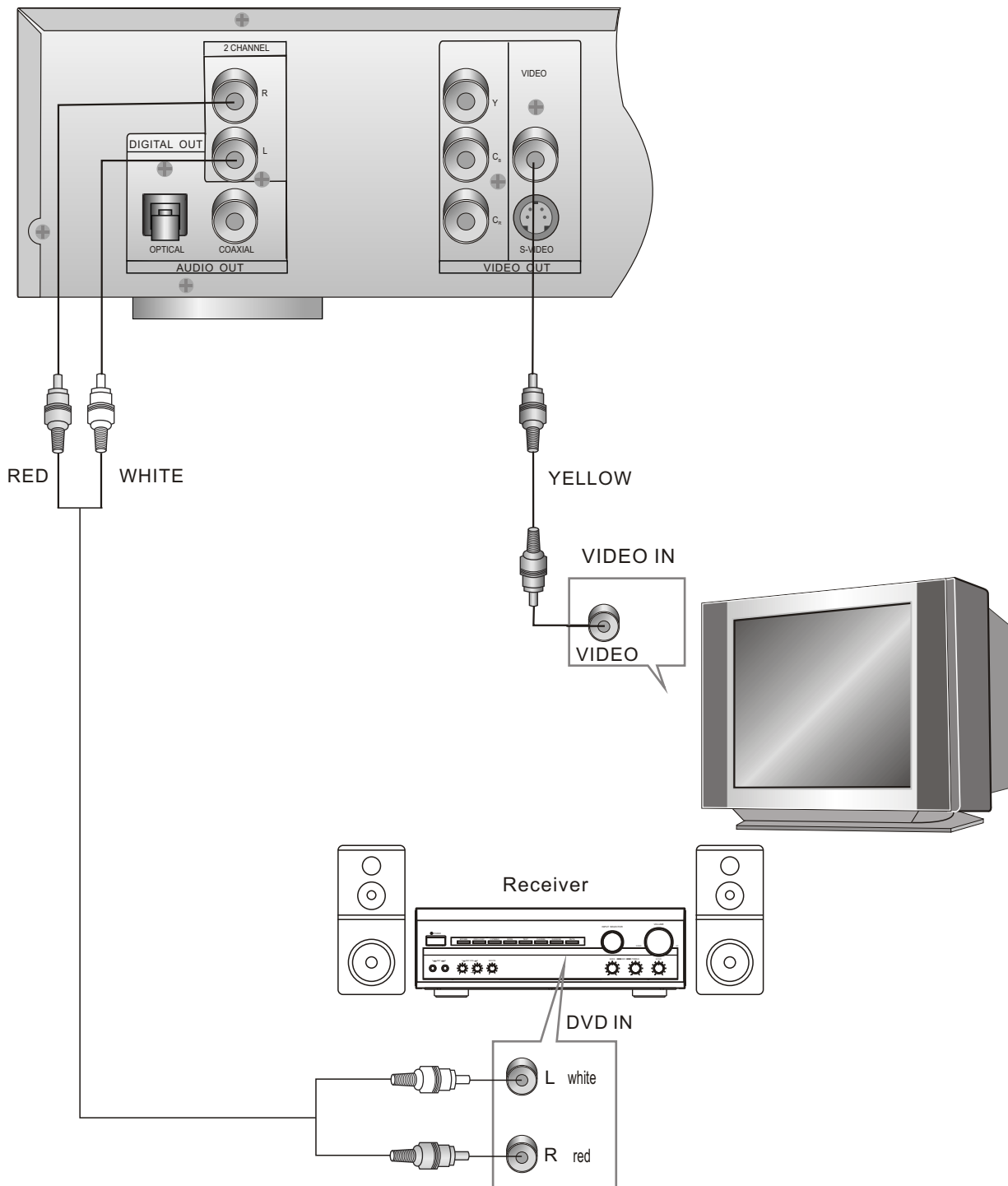

Notes:

- 1. Set the TV to the AV input connected to the DVD player.
- 2. Set the amplifier to the AV input connected to the DVD player..

Connecting to an AV amplifier with digital audio input

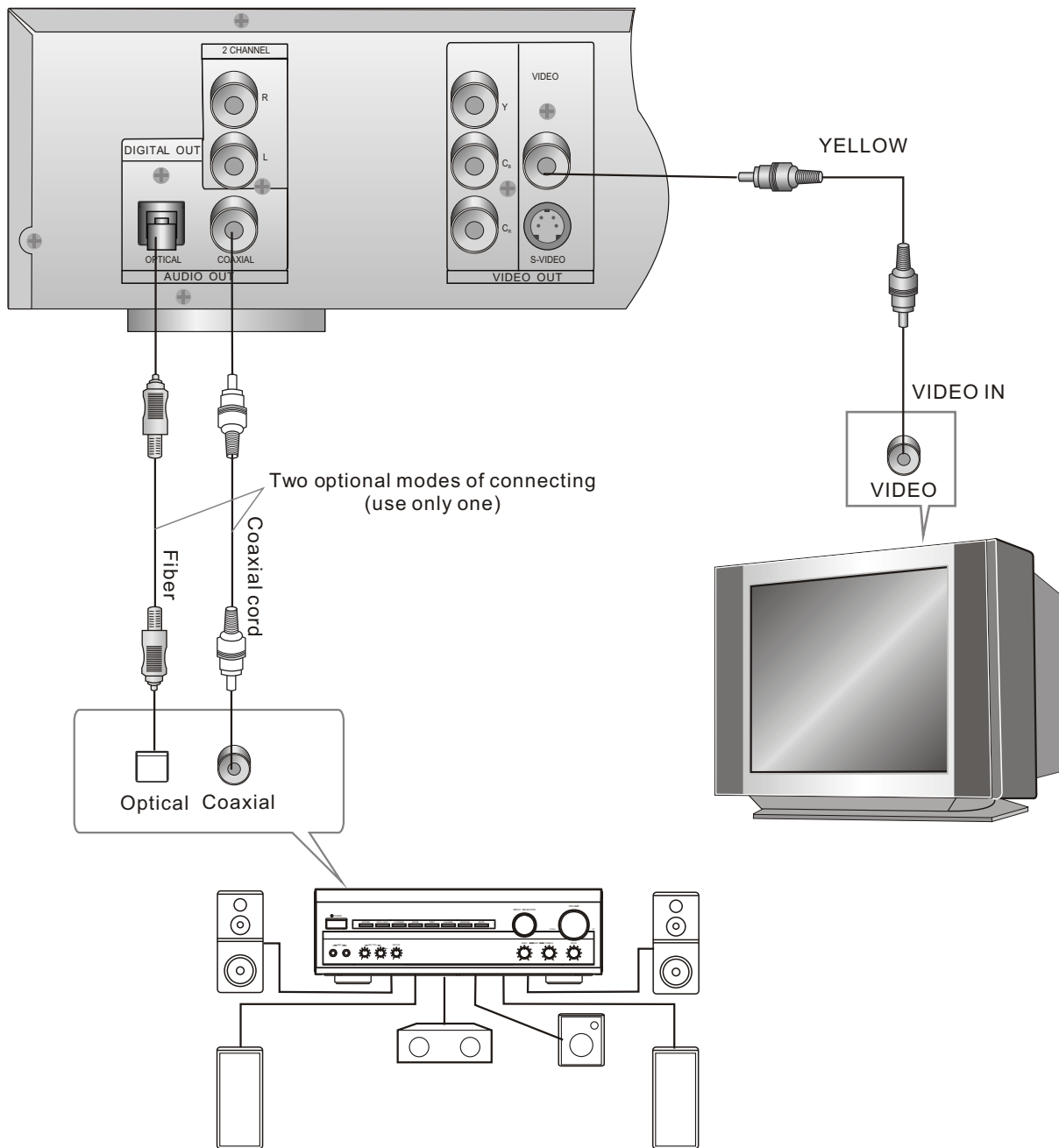

Notes:

1. Select either the Optical or the Coaxial digital audio output.
2. Set the player's audio out to Bitstream or PCM mode (see page 19).
3. Set the amplifier to the AV input connected to the DVD player

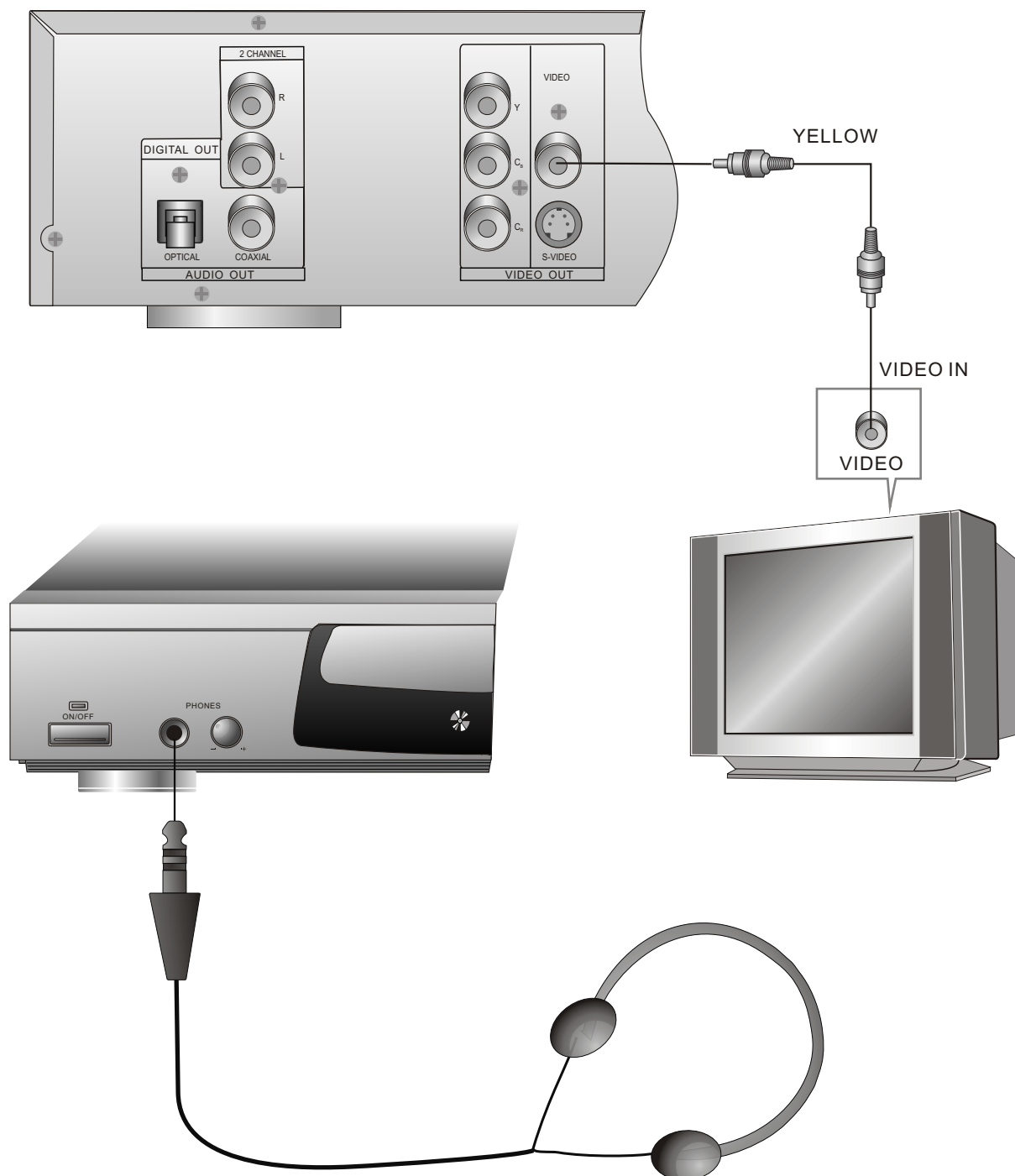

Before using the headphones, please:

1. Turn down the headphone volume to minimum.
2. Connect the headphones as above, and adjust the headphones volume with the volume knob.

Basic Operation

Basic Playback

Preparation before playing:

1. Connect the DVD player to your TV and amplifier.
2. Turn on the TV.
3. Set the TV to the AV input connected to the DVD player.
4. Turn down the volume on your amplifier, and then power it on.
5. Set the amplifier to the AV input connected to the DVD player.



STEP 1 - Press the **ON/OFF** switch, and the player will start. "LOAD" is illuminated on the display and the logo is displayed on TV screen.

STEP 2 - Press **OPEN/CLOSE** button either on front panel or remote control, The player displays "OPEN" on the display. When the tray is open, please put the disc on the tray with the label side up. Press **OPEN/CLOSE** again to close the disc tray.

STEP 3 - Press the **PLAY** button on the front panel or remote control. The player will automatically read and identify the disc, display the type and total time, and begin playback.

Modes and Features Setup

Advanced Features

ON SCREEN DISPLAY (OSD)/SETUP



In stop mode, press **OSD/SETUP**, and the TV screen will display the setup menu as follows:

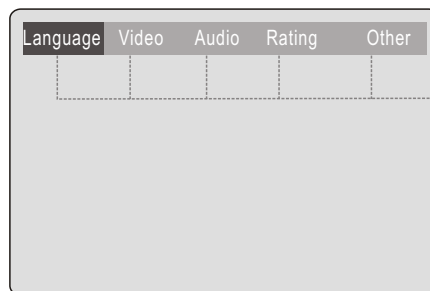

Press to change items

Setup Menu

- A. Press **ENTER** to display the submenu
- B. Press **OSD/SETUP** to exit the Setup Menu

Language Setup

Select [Language] in the Setup Menu, and press **ENTER** to display the [Language] submenu:

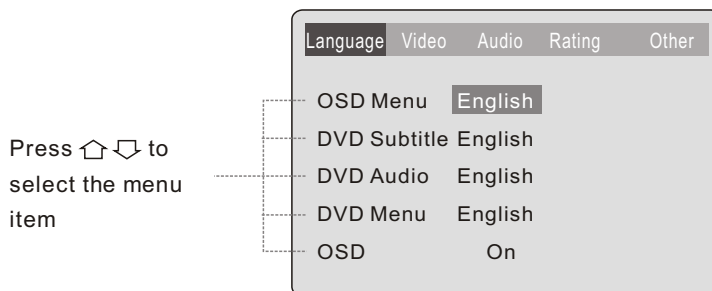

Press to select the menu item

- A. Press **ENTER** or to change the setting
- B. Press to go back one menu.
- C. Press **RETURN** to return to the Setup Menu.

Select [OSD Menu], and press **ENTER** or to display the [OSD Menu] submenu:

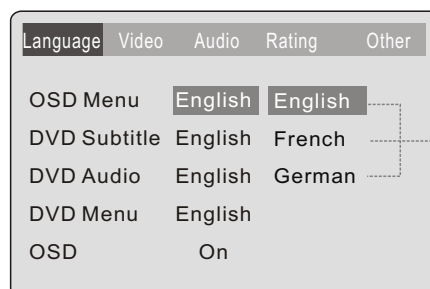

Press to change your selection

- A. Press **ENTER** to confirm
- B. Press **OSD/SETUP** to exit the Setup Menu

Modes and Features Setup

Advanced Features

Language Setup

Select [DVD Subtitle], and press **ENTER** or \leftarrow to display the [Subtitle] submenu:

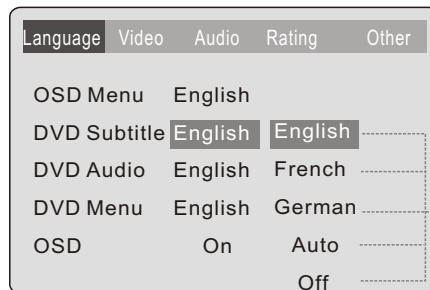

Press \uparrow \downarrow to change your selection

- A. Press **ENTER** to confirm
- B. Press **OSD/SETUP** to exit the Setup Menu

Select [DVD Audio], and press **ENTER** or \leftarrow to display the [Audio] submenu:



Press \uparrow \downarrow to change your selection

- A. Press **ENTER** to confirm
- B. Press **OSD/SETUP** to exit the Setup Menu

Select [DVD Menu], and press **ENTER** or \leftarrow to display the [DVD Menu] submenu:

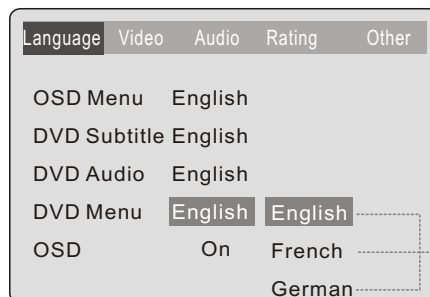

Press \uparrow \downarrow to change your selection

- A. Press **ENTER** to confirm
- B. Press **OSD/SETUP** to exit the Setup Menu

Select [OSD], and press **ENTER** or \leftarrow to display the [OSD] submenu:

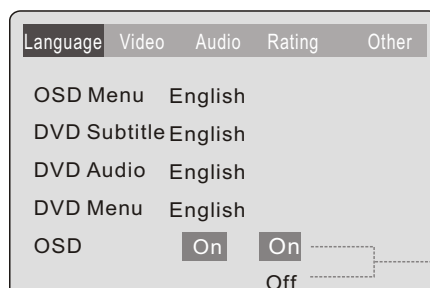

Press \uparrow \downarrow to change your selection

- A. Press **ENTER** to confirm
- B. Press **OSD/SETUP** to exit the Setup Menu

Video Setup

Select [Video] in the Setup Menu, and press **ENTER** to display the [Video] submenu:

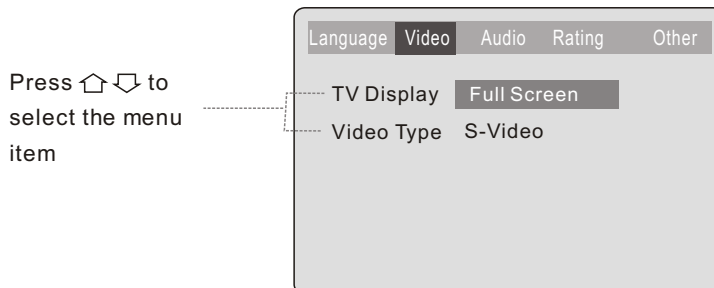

- A. Press **ENTER** or **→** to setup
- B. Press **RETURN** or **←** to return to the Setup Menu

Select [TV Display], and press **ENTER** or **→** to display the [TV Display] submenu:

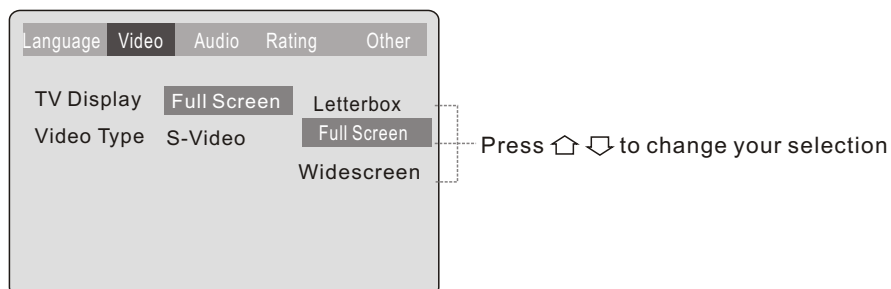

- A. Press **ENTER** to confirm
 - B. Press **OSD/SETUP** to exit the Setup Menu
- [Letterbox]----The full width of the picture is displayed on a standard 4:3 television, but black bars appear above and below the picture.
- [Full Screen]----The full height of the picture is displayed on a standard 4:3 television, but some left/right detail is lost as the movie "pans and scans" to keep the most important action on the screen.
- [Widescreen]----The picture fills the screen of a wide-screen (16:9) television.
- Note:** Not all DVDs offer movies in Full Screen format. If not, the disc will override your TV Display setting and the movie will be displayed in Letterbox format..

Modes and Features Setup

Advanced Features

Video Setup

Select [Video Type], and press **ENTER** or \rightarrow to display the [Video Type] submenu:

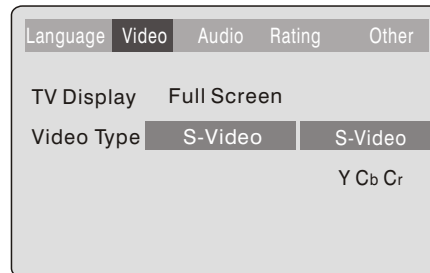

Press \uparrow \downarrow to change your selection

- A. Press **ENTER** to confirm B. Press **OSD/SETUP** to exit the Setup Menu
[S-Video]----S-video output
[YCbCr]----component video output

Audio Setup

Select [Audio] in the Setup Menu, and press **ENTER** to display the [Audio] submenu:

Press \uparrow \downarrow to select the menu item

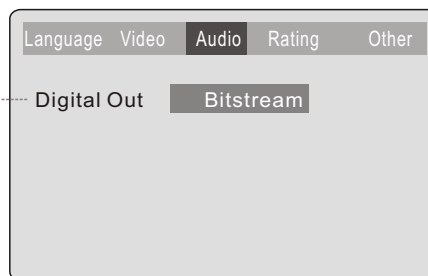

- A. Press **ENTER** or \rightarrow to setup
B. Press **RETURN** or \leftarrow to return to the Setup Menu

② Select [Digital Out], and press **ENTER** or \rightarrow to display the [Digital Out] submenu:

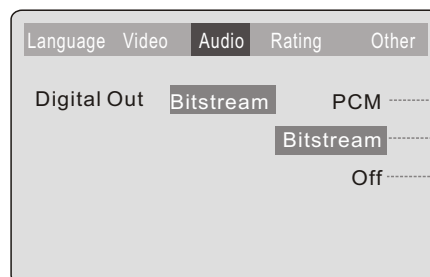

Press \uparrow \downarrow to change your selection

- A. Press **ENTER** to confirm
B. Press **OSD/SETUP** to exit the Setup Menu

[PCM]----digital audio output in PCM (pulse code modulation) format; use for stereo or CD playback.



[Bitstream]----digital audio out in original format; use if you connect to an A/V receiver with a Dolby Digital or DTS decoder.

[Off]----no digital audio out

Rating Setup

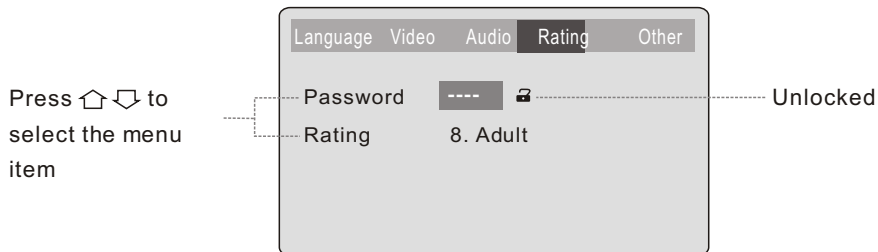
Select [Rating] in the Setup Menu, and press **ENTER** to display the [Rating] submenu:



- A. Press **ENTER** or  to setup
- B. Press **RETURN** or  to return to the Setup Menu

Note: Not all DVDs support Ratings.

Use the 0-9 keys to input four digits, then press **ENTER** to confirm. The [Rating] submenu displays as follows:

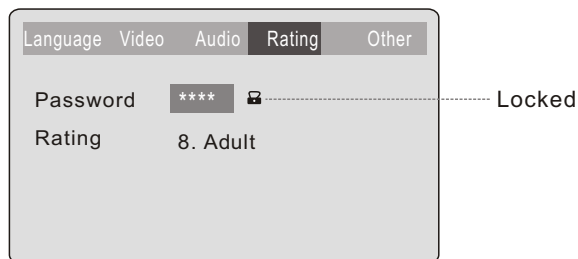

Note: If you forget your password, please use the universal password (listed on the last page of this manual) to unlock.

Select [Rating], and press **ENTER** to change [Rating] mode.

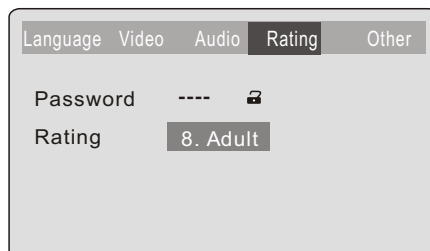

- A. Press **ENTER** repeatedly to select: 1. Kid Safe, 2. G, 3. PG, 4. PG-13, 5. PG-R, 6. R, 7. NC-17, 8. Adult
- B. Press **RETURN** to return to the Setup Menu



Note: Unlock the password before setting [Rating].

Modes and Features Setup



Advanced Features

Other Setup items

Select [Other] in the Setup Menu, and press **ENTER** to display the [Other] submenu:



Press   to select the menu item

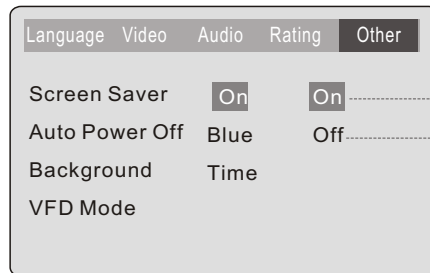

- A. Press **ENTER** or  to setup
- B. Press **RETURN** or  to return to the Setup Menu

Select [Screen Saver], and press **ENTER** or  to display the [Screen Saver] submenu:



Press   to change your selection

- A. Press **ENTER** to confirm
- B. Press **OSD/SETUP** to exit the Setup Menu

Select [Auto Power Off], and press **ENTER** or  to display the [Auto Power Off] submenu:

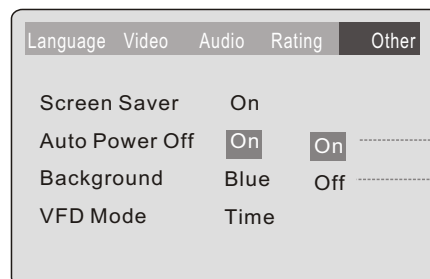



Press   to change your selection

- A. Press **ENTER** to confirm
- B. Press **OSD/SETUP** to exit the Setup Menu

Other Setup Items

Select [Background], and press **ENTER** or  to display the [Background] submenu:





Press   to change your selection

- Press **ENTER** to confirm
- Press **OSD/SETUP** to exit the Setup Menu

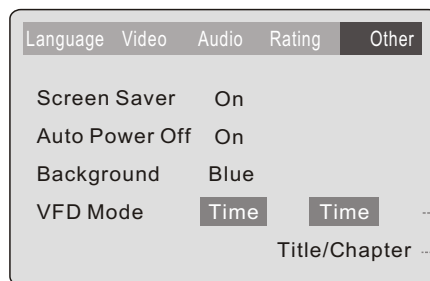
Select [VFD Mode], and press **ENTER** or  to display the [VFD Mode] submenu:



Press   to change your selection

- Press **ENTER** to confirm
- Press **OSD/SETUP** to exit the Setup Menu

[Time]----Time indicator on VFD displays the time.

[Title/Chapter]----Track indicator on VFD displays the title, and the time indicator displays the chapter.

Note: This setup is available only during DVD playback.

STANDBY/ON



During playback, press **STANDBY/ON** to stop the player and return to standby mode. The standby indicator will turn on.

While the player is in standby, press **STANDBY/ON** or any key on the front panel to resume normal operation. The standby indicator will turn off.

TITLE



During DVD playback, press **TITLE** to display the DVD title menu or play the first title.

Note: This function is subject to the disc.

MENU



During DVD playback, press **MENU** to display the disc menu of the current title.

Note: This function is subject to the disc.

OPEN/CLOSE



To open the disc tray, press **OPEN/CLOSE**.

To close the disc tray, press **OPEN/CLOSE** again.

Remote Control Operation

Advanced Features

OSD/SETUP



During playback, press **OSD/SETUP** to display the current time counter position.

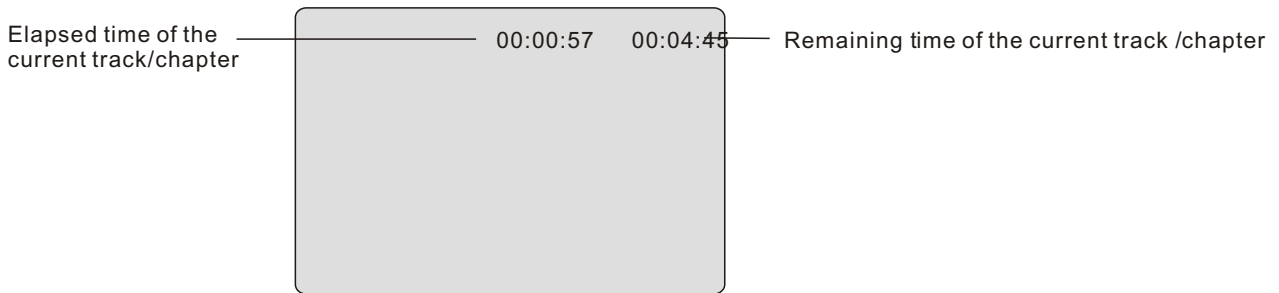

Press **OSD/SETUP** again to display additional information about the playing disc.

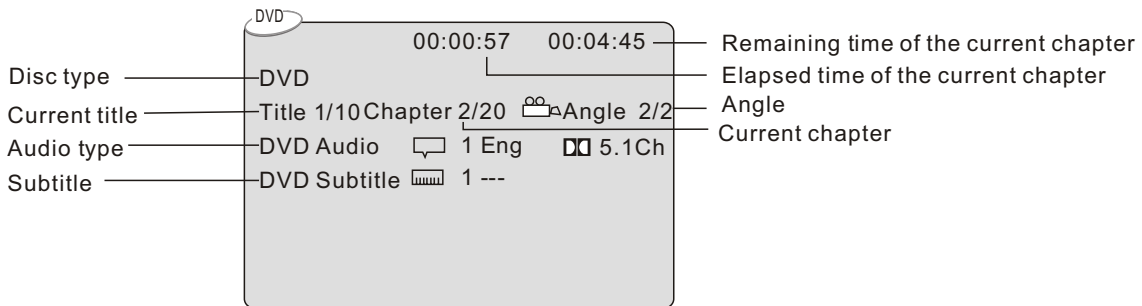
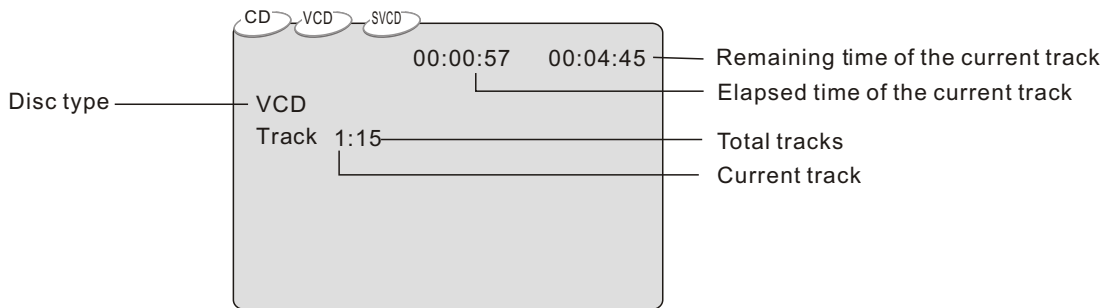

For CDs, press **OSD/SETUP** a third time to display the dynamic frequency spectrum. Press it again to turn off the spectrum.

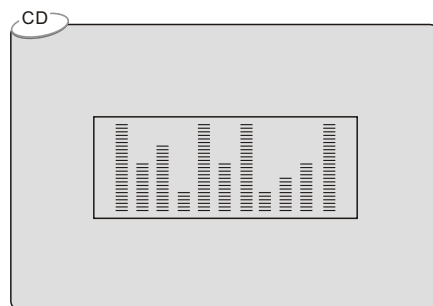

Note: Press stop to access other modes.

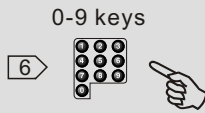

These keys are used to input the time, as well as title, chapter and track numbers.

When a numeric item is displayed on the screen, press the 0-9 keys to select the desired entry, and press **ENTER** to confirm.

When a CD or VCD is playing (with PBC off), press the 0-9 keys to select a track directly, then press **ENTER** to confirm.



During DVD, VCD or SVCD playback, press **SLOW FWD** for slow motion playback.

Once you press **SLOW FWD**, the disc will play at 1/2, 1/4, 1/6 and 1/7 normal speed as follows:

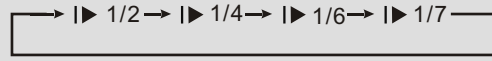

Press **PLAY** to resume normal playback.



During DVD, CD or VCD playback, press **PREV/REV** once to play the previous chapter, title or track.

During DVD, CD or VCD playback, press and hold **PREV/REV** to scan in reverse. The player will review the disc at 2, 4, 8 and 20 times normal speed as follows:

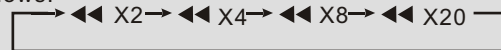

Press **PLAY** to resume normal playback.



During DVD, CD or VCD playback, press **NEXT/FWD** once to play the previous chapter, title or track.

During DVD, CD or VCD playback, press and hold **NEXT/FWD** to scan forward. The player will cue the disc at 2, 4, 8 and 20 times normal speed as follows:

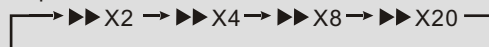

Press **PLAY** to resume normal playback.

Remote Control Operation

Advanced Features



Use the number keys to input the desired [Time], [Relative Time] or [Title/Chapter] then press **ENTER** to confirm.

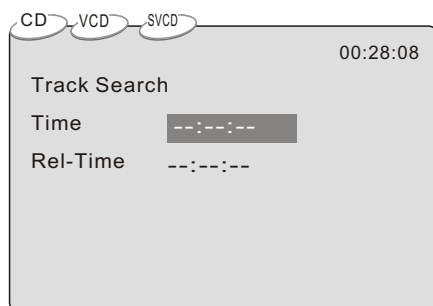

Notes: During CD playback, press **SEARCH** to display the [Track Search] menu, and press it again to display the [Disc Search] menu.
During VCD and SVCD playback (with PBC off), press **SEARCH** twice to display the [Disc Search] menu.

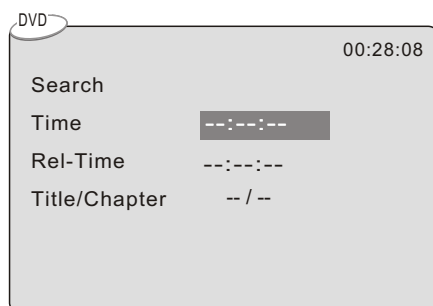

Notes: Time searches for an exact time in the movie. Relative time searches relative to the current counter position
In [Title/Chapter] mode, you cannot enter a value outside the range of the total number of titles/chapters..
When searching with [Rel-Time], press and hold "0" to change [Rel-Time] to negative (to search backward).
For some DVD discs, the Search function is unavailable.



Press **CLEAR** to delete numbers you have entered.
Press once to delete one digit. Press and hold to delete all digits.

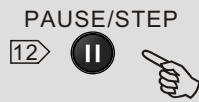

Press **PAUSE/STEP** during playback to pause playback.
Press **PAUSE/STEP** again to step forward one frame.
Press **PLAY** to resume normal playback.
Note: The step function is not available during CD playback.



Press **PLAY** from stop mode to start playback.
Press **PLAY** during playback to replay the last 10 seconds.
If the elapsed time of the current track is less than 10 seconds,
the player will skip ahead 10 seconds.
Note: MP3 discs and some DVD discs do not have a 10 second review feature.



Press **STOP** once during playback to stop and hold playback.
Press **PLAY** to resume playback from the point you pressed **STOP**.
Press **STOP** twice to stop playback completely.
Note: The screen saver will automatically turn on
if playback is stopped for more than 5 minutes.

RETURN

17



During DVD, VCD or SVCD playback (with PBC on), press **RETURN** to return to the program menu.

In the Setup Menu, press **RETURN** to return to the main menu.

In some menus, pressing **RETURN** cancels the current display.

A-B

18



During playback, press **A-B** to select point A.

Press it again to select point B. The player will repeat the section from A to B automatically.

Press **A-B** a third time to cancel A-B repeat and clear points A and B.

Note: During CD/VCD/SVCD playback, points A and B must be within the same track.

During DVD playback, points A and B can be selected from different chapters.

MEMORY

19



During disc playback, press **MEMORY** to bookmark the current disc position.

Press **MEMORY** again to play the disc from the bookmarked position (this also clears the bookmark so you can set a new one).

Note: The bookmark will be saved even if the player is powered off.

The player can save the bookmark for CD VCD SVCD and DVD independently, but only one bookmark can be saved for each type of disc. This function is unavailable for MP3.

Remote Control Operation

Advanced Features



Press **PLAY MODE** to display the [Play Mode] menu:

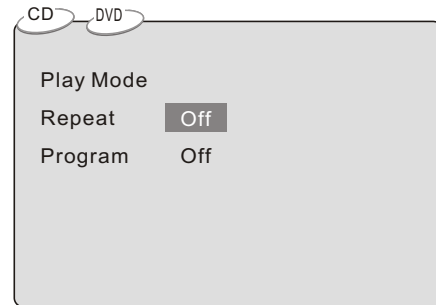
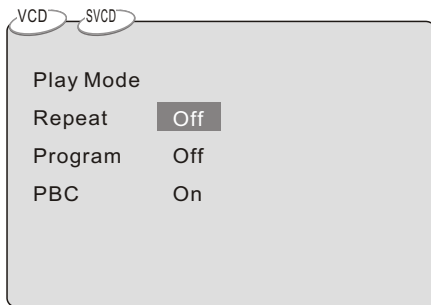

Press to select the menu item

Select [Repeat], and press **ENTER** or to display the [Repeat] submenu:

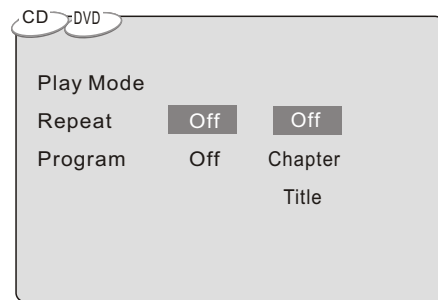
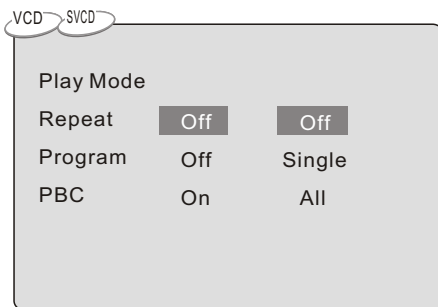

Press to change your selection

- Press **ENTER** to confirm
- Press **PLAY MODE** or **RETURN** to exit the menu

Note: PBC (Playback Control used to navigate VCDs) is not available for CDs.

Select [Program], and press **ENTER** or to display [Program] submenu:

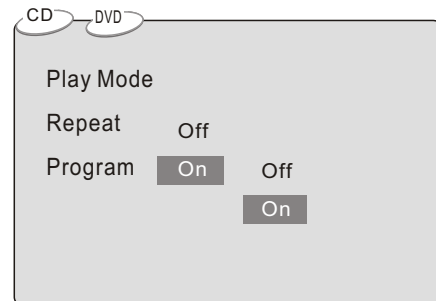
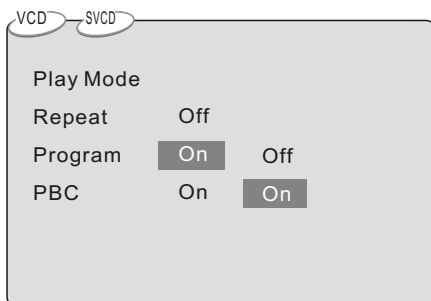

Press to change your selection

- Press **ENTER** to confirm
- Press **PLAY MODE** or **RETURN** to exit the menu

While [Program] is on, press **ENTER** to display the [Program] submenu:

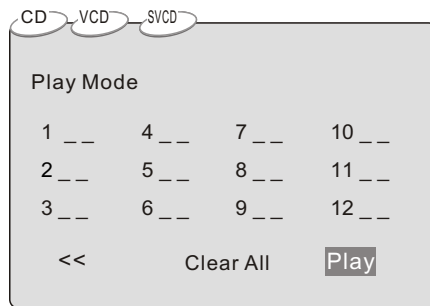

Input the track numbers in the order you would like them to play. When finished, select [Play] and then press **ENTER** to play the tracks in the new programmed order. To clear all the numbers you have entered, select [Clear All] and then press **ENTER**. To return to the [Play Mode] menu, select [<<] and then press **ENTER**.

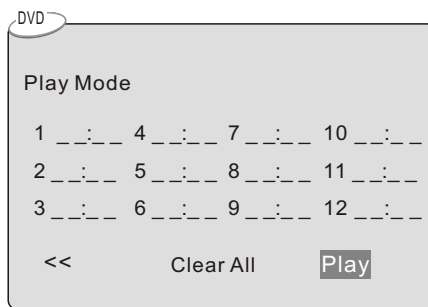

Input the title number and the chapter number in the desired order. Then select [Play] and press **ENTER** to play the chapters in the order you have set. Select [Clear All] and press **ENTER** to clear all the numbers you have input. Select [<<] and press **ENTER** to return to the [Play Mode] menu.

Select [PBC], and press **ENTER** or **↵** to display the [PBC] submenu:

(PBC, or playback control, provides advanced track selection options during VCD playback.)

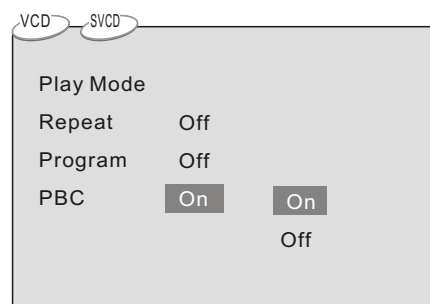

- A. Press **ENTER** to confirm
- B. Press **PLAY MODE** or **RETURN** to exit the menu

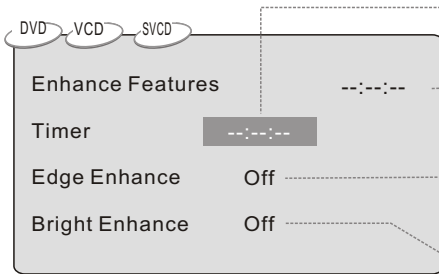

Note: Enhance Features are not available during MP3 playback.

The Timer feature allows you to automatically power off the player after a specified length of time (up to 99:59:59). If you input "0", the timer function is disabled.

The time remaining until the power is turned off is shown here.

Edge Enhance sharpens or softens edges during DVD, VCD or SVCD playback. Press **ENTER** to select Off, Sharpen or Soften.

Bright Enhance increases the contrast during DVD, VCD or SVCD playback. Press **ENTER** to select Off or On.



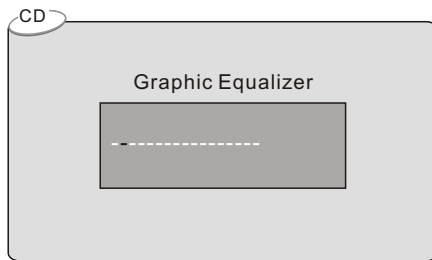

The equalizer allows you to adjust 6 frequency bands independently.



Note: Not available for DVD, MP3, VCD or SVCD playback.



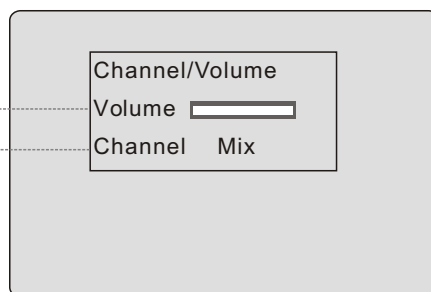

Press **VOL/CH**, and the [Channel/Volume] menu will display as follows:

Press   to select the menu item

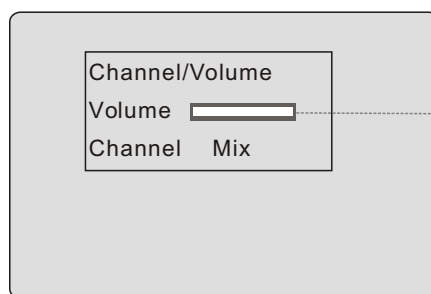

Select [Volume], the screen will display as follows:



Press   to adjust the volume

Press **VOL/CH** again to exit the menu.

Select [Channel], the screen will display as follows:



- A. Press **ENTER** repeatedly to change the selection
- B. Press **VOL/CH** again to exit the menu.



During VCD/SVCD/DVD playback, press **ZOOM** to magnify the image as follows:

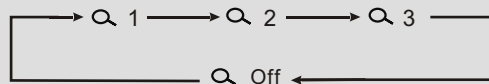

During DVD playback

Press **ANGLE** to view scenes from different camera angles.

Press **ANGLE** repeatedly to change from one camera angle to another.

Note: The function is disc specific.

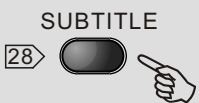

During DVD playback

Press **SUBTITLE** repeatedly to select from up to 32 subtitle languages.

Note: This function is disc specific.

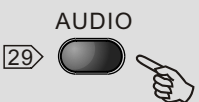

During DVD playback

Press **AUDIO** repeatedly to select from up to 8 audio languages/formats.

During SVCD playback

Press **AUDIO** repeatedly to select from up to 4 audio languages/formats.

Note: This function is disc specific.

Supported formats

Disc format: ISO 9660, Joliet

Music file formats: MP3

MP3 bit rate (data rate): 32--320kbps

Total number of music files and albums: around 350 per disc

Sampling rate: 32kHz/44.1kHz/48kHz

Note The player will not identify or play MP3 discs under the following conditions: recording format is not supported, badly scratched or deformed disc, MP3 recorded in CD-R or CD-RW which is not finalized, or a dirty pickup.

When an MP3 disc is loaded, the screen will display as follows:

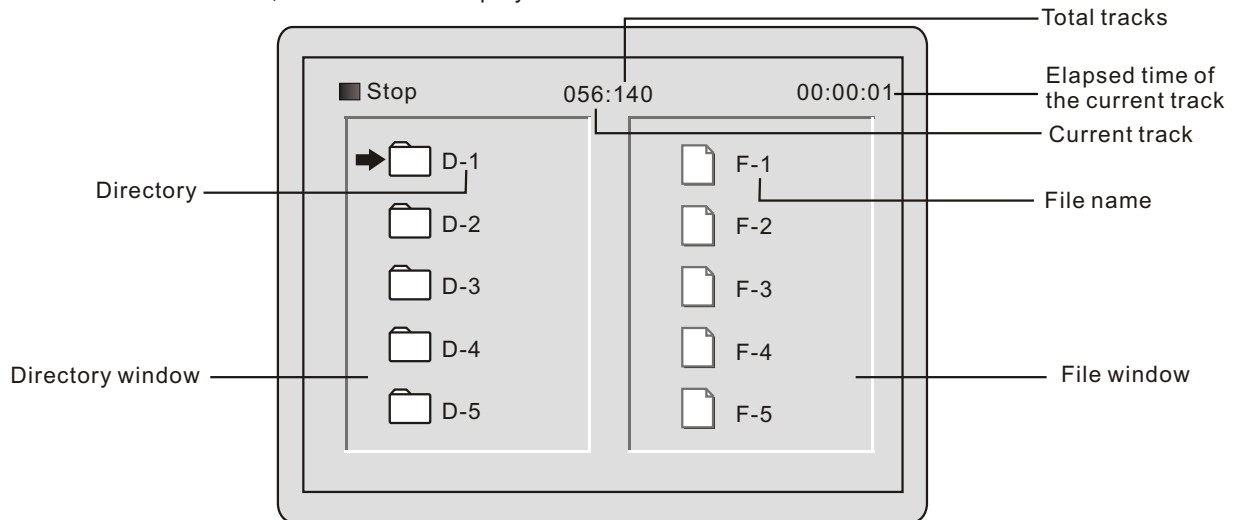

Press \uparrow \downarrow to select the directory.

Press **ENTER** or **PLAY** to play the first file in the directory selected by the cursor in the directory window. The cursor will automatically move to the file playing in the file window.

Note: The player supports English directory and file names only. Other languages will display as "D-X" for the directory name and "F-X" for the file name, where X is the next number of the directory or file in sequential order.

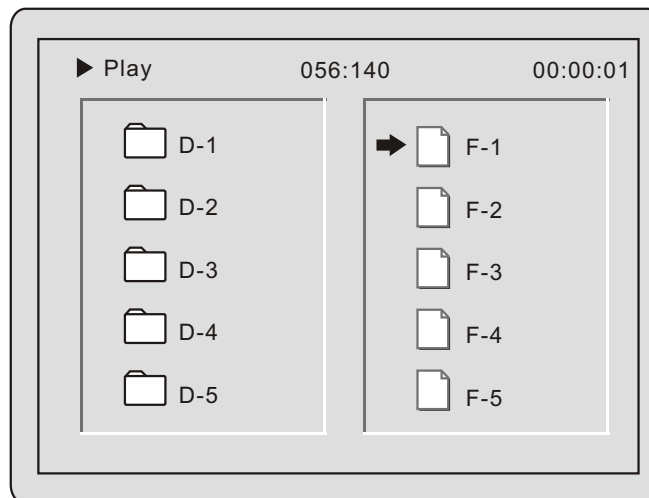

Press \uparrow \downarrow to select the file when the cursor appears in the file window.

Press **ENTER** or **PLAY** to play the current file selected by cursor in the file window.

Press \leftarrow \rightarrow to switch between the directory window and the file window.

Note: During MP3 playback, **PREV/REV** and **NEXT/FWD** are not available.

If you have any questions, please consult the troubleshooting guide below. If you cannot solve the problem, please contact our customer support department at 480-922-0896 or via e-mail at customersupport@sonicblue.com .

NO PICTURE OR SOUND

- Ensure the power switch is on.
- Ensure the power outlet is operational.
- Ensure the power cord is not damaged.
- Ensure the power plug is connected firmly to the outlet.

PICTURE BUT NO SOUND

- Ensure the audio jacks are securely connected.
- Ensure the audio connector is not damaged.
- Ensure the volume is turned up in VOL/CH setup.
- Ensure you have set the player's AUDIO settings correctly.
- Ensure you have selected the correct AV input for your TV
- Ensure the audio is not set to mute.

SOUND BUT NO PICTURE

- Ensure the video jacks are securely connected
- Ensure you have selected the correct AV input for your TV.
- Ensure the video connector is not damaged.
- Ensure you have set the player's VIDEO settings correctly.

POOR PICTURE OR SOUND

- Ensure you have set the player's AUDIO settings correctly.
- Ensure the disc is not scratched or stained.
- Ensure the AV connector or the output terminal is not damaged.

"BAD DISC" DISPLAYED

- Ensure the disc is not warped, damaged or deformed.
- Ensure the disc is not badly stained or damaged.
- Ensure the disc format is compatible with the player.

NO SOUND FROM HEADPHONES

- Ensure the headphones are in working order.
- Ensure the headphones volume is not set at Min.
- Ensure the headphones are firmly connected to the headphones jack.

REMOTE NOT WORKING

- Ensure the remote batteries are working.
- Point the remote control directly at the player's IR sensor.
- Remove any obstacles between the remote and the IR sensor.

UNIT NOT WORKING

- Turn off the power, and then turn it on again.

"NO DISC" DISPLAYED

- Ensure you have put the disc on the tray.
- Ensure the disc is not upside down.
- Ensure the disc is not distorted, stained or scratched.

Specifications

Power requirements: ~110-240V 50/60Hz

Power consumption: 25W

Video standard: NTSC

Weight: 7 Lbs (3.2kg)

Dimensions: 17in(W) x 12.9in(D) x 3in(H)(product),(430mm(W) x 328mm(D) x 75mm(H))

Video out

Video out: 1.0V(p-p)/75 sync, negative polarity, RCA pin Jack x 1

S-video output connector(separate Y signal output connector):

Y output: 1.0V(p-p)/ 75 sync, negative polarity

C output: 0.286V(p-p)/75

4 pin miniDIN x 1

Audio out

Analog out: 1.85V(rms)/10k RCA pin Jack(L,R) x 1

Coaxial out: 0.5V(p-p)/75 RCA pin Jack x 1

Optical out: Optical Fiber Transmitter

Frequency response: 20Hz to 20kHz

S/N ratio: >90dB

Total harmonic distortion: < 0.05%

[Accessories]

Audio/Video cord 1

Remote Control 1

Batteries(AAA) 2

Specifications are subject to change without notice.

Weight and dimensions are approximate.

Remote Control Preparation

Items

Insert batteries

1

1. Open the cover.

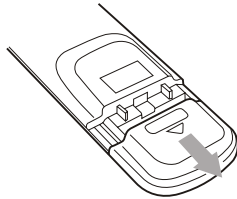

2

2. Insert batteries.

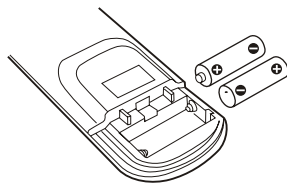

Make sure to match the "+" and "-" of the batteries with the marks inside the battery compartment.

3

3. Close the cover.

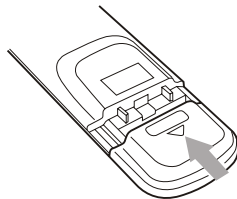

Notes:

Improper use of batteries may cause battery leakage and corrosion. To operate the remote control correctly, follow the instructions below:

Do not insert the batteries in the wrong direction.

Do not charge, heat, open, or short-circuit the batteries.

Do not throw batteries into a fire.

Do not leave dead batteries in the Remote Control.

Do not use different types of batteries together, or mix old and new batteries.

If you do not use the remote control for a long period of time, remove the batteries to avoid possible damage from battery corrosion.

If the remote control does not function correctly or the operating range becomes reduced, replace all batteries with new ones.

If battery leakage occurs, clean the battery compartment, then insert new ones.

Using the remote control

Point the remote control at the remote sensor.

(The pictures below are for reference only.)

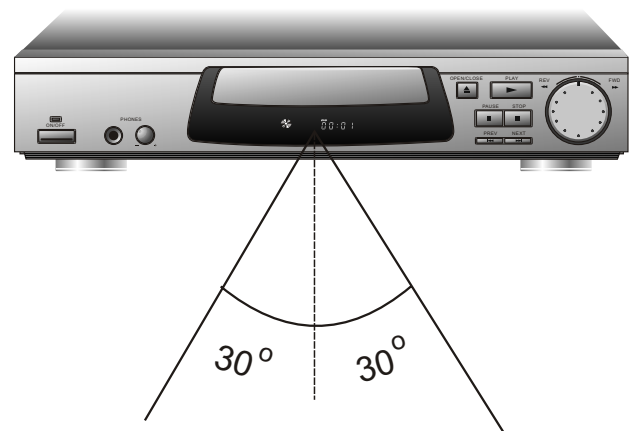

Distance: About 15ft from the front of the remote sensor.

Angle: About 30 degrees in either direction relative to the remote sensor.

Remarks: Do not expose the remote sensor of the DVD Player to a strong light source, such as direct sunlight.

Notes:

Point the remote control directly at the player's remote sensor.

Do not leave the remote control in an extremely hot or humid place.

Do not spill water or put anything wet on the remote control.

Battery life is ~1 year under normal conditions.

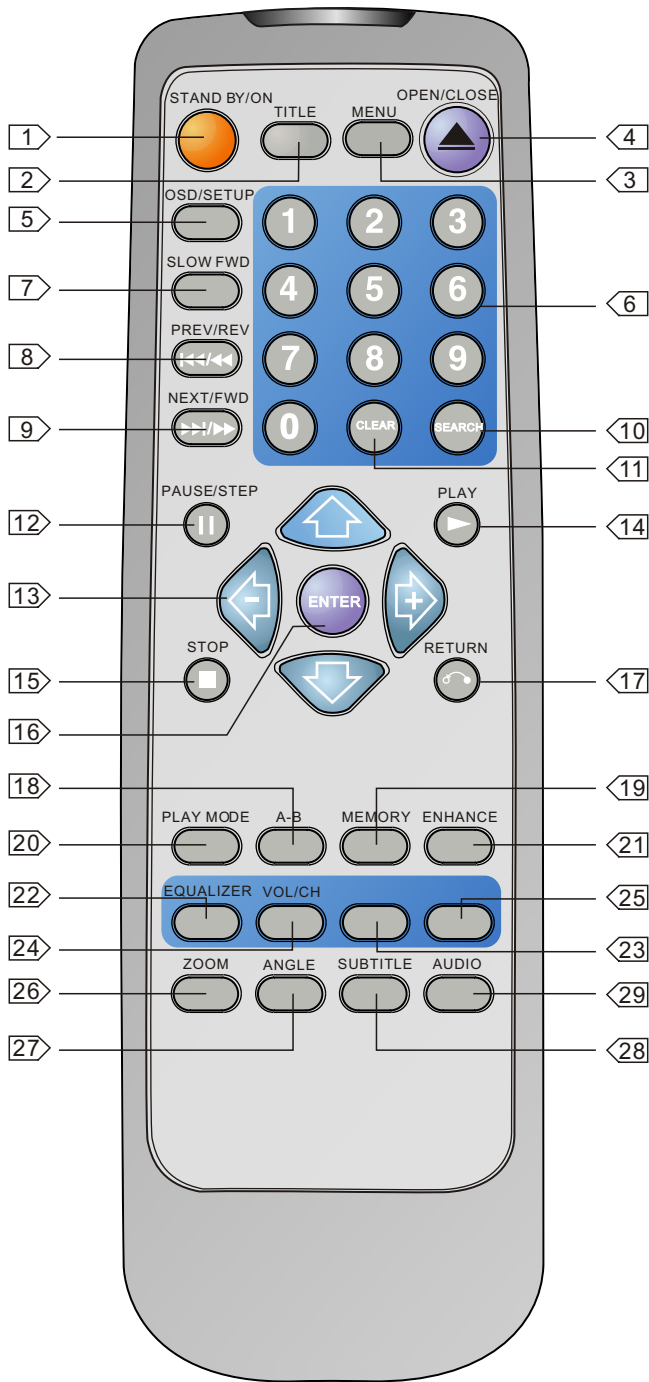

Warning

To prevent children from watching programs which have a rating above their age, please be sure to set the rating in the set up menu appropriately. Before you set this rating, the password must be unlocked. If you forget your unique password, then please use the universal password as set by the manufacturer. The universal password is "0106". Please detach this sheet and



Free Manuals Download Website

<http://myh66.com>

<http://usermanuals.us>

<http://www.somanuals.com>

<http://www.4manuals.cc>

<http://www.manual-lib.com>

<http://www.404manual.com>

<http://www.luxmanual.com>

<http://aubethermostatmanual.com>

Golf course search by state

<http://golfingnear.com>

Email search by domain

<http://emailbydomain.com>

Auto manuals search

<http://auto.somanuals.com>

TV manuals search

<http://tv.somanuals.com>