

DP6240

Portable DVD Player

User's Guide



www.govideo.com

GO.VIDEO®

Table of Contents

FCC and Safety Information	3	Other Disc Playback.....	16
Important Safety Instructions.....	4	Playing Audio CDs.....	16
Player Overview.....	5	Playing Kodak Picture CDs	17
Front View	5	Playing JPEG Picture CDs	18
Side Views.....	6	Playing MP3 CDs	19
Remote Control	7	Playing CDs with MP3 and JPEG files	19
Inserting Remote Control Batteries	7	Language Setup.....	20
Quick Start	8	On Screen Display (OSD) Language	20
Step 1 - Connect AC Adapter	8	Disc Menu Language	20
Step 2 - Connect Headphones (Optional)	8	Audio Language [DVD].....	21
Step 3 - Open Top Panel	8	Subtitle Language [DVD].....	21
Step 4 - Turn on Power	8	Screen Setup	22
Step 5 - Open Disc Cover	8	TV Type	22
Step 6 - Insert Disc.....	8	Screen Saver.....	22
Step 7 - Close Disc Cover	8	TV System.....	23
Step 8 - Play Disc.....	8	Video Output.....	23
Battery Pack Overview	9	Audio Setup	24
Charging the Battery Pack	9	Digital Audio Output [DVD]	24
Connections	10	Custom Setup	25
Basic TV Connections	10	Parental Control [DVD].....	25
Enhanced Video Connections	10	Change Password [DVD]	25
Enhanced Audio Connections	11	Angle Mark [DVD]	26
External Device Connections	11	Restore Defaults.....	26
DVD Playback	12	LCD Setup	27
Before You Begin.....	12	Panel	27
Basic DVD Playback	12	Color	27
Viewing Disc Menus	12	Brightness	27
Stopping Playback.....	12	Invert	27
Forward/Reverse Scan.....	13	Close	27
Skip Next/Previous	13	Troubleshooting	28
Pause	13	Disc Handling & Maintenance	29
Repeat.....	13	Parts & Accessories	30
Special DVD Features	14	Limited Warranty	31
Displaying Scene Information.....	14		
Audio	14		
Subtitles.....	14		
Angle	15		
Mute	15		
Title	15		
Disc Menu	15		

©2004 GoVideo. All rights reserved. Printed in China.

GoVideo is a registered trademark. "Dolby", "Pro Logic", and the double D symbol are trademarks of Dolby Laboratories. The product complies with the KODAK Picture CD format and will display KODAK Picture CDs. The "KODAK Picture CD Compatible" logo is a trademark of Eastman Kodak Company and is used with permission. All other brand and product names are trademarks or registered trademarks of their respective companies.

GoVideo shall not be liable for any errors contained herein or for any damages arising out of or related to this document or the information contained herein, even if GoVideo has been advised of the possibility of such damages. This document is intended for informational and instructional purposes only. GoVideo reserves the right to make changes in the specifications and other information contained in this document without prior notification. GoVideo disclaims any obligation to update the information contained herein.

FCC and Safety Information

NOTE:

This equipment has been tested and found to comply with the limits for a Class B digital device pursuant to part 15 of the FCC Rules. These limits are designed to provide reasonable protection against harmful interference in a residential installation. This equipment generates, uses and can radiate radio frequency energy and, if not installed and used in accordance with the instructions, may cause harmful interference to radio communications. However, there is no guarantee that interference will not occur in a particular installation. If this equipment does cause harmful interference to radio or television reception, which can be determined by turning the equipment off and on, the user is encouraged to try to correct the interference by one or more of the following measures:

- Reorient or relocate the receiving antenna.
- Increase the separation between the equipment and receiver.
- Connect the equipment into an outlet on a circuit different from that to which the receiver is connected.
- Consult the dealer or an experienced radio/TV technician for help.

Macrovision Notice

This product incorporates copyright protection technology that is protected by method claims of certain U.S. patents and other intellectual property rights owned by Macrovision Corporation and other rights owners. Use of this copyright protection technology must be authorized by Macrovision Corporation, and is intended for home and other limited viewing uses only unless otherwise authorized by Macrovision Corporation. Reverse engineering or disassembly is prohibited.

CAUTION

VISIBLE AND INVISIBLE LASER RADIATION WHEN OPEN AVOID EXPOSURE TO BEAM. WARNING LOCATION: INSIDE ON LASER COVERSIELD.

CLASS 1 LASER PRODUCT
KLASSE 1 LASER PRODUKT
LUOKAN 1 LASER LAITE
KLASS 1 LASER APPARAT
CLASSE 1 PRODUIT LASER

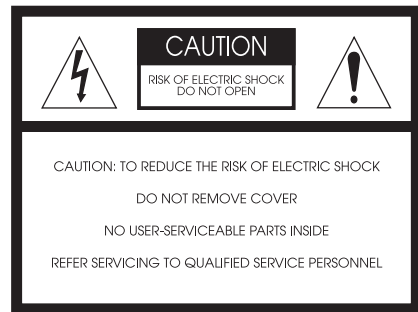

CAUTION:

This unit employs a laser. Due to possible eye injury, only qualified service personnel should remove the cover or attempt to service this device. Use of controls or adjustments or performance of procedures other than those specified herein may result in hazardous radiation exposure.

Region Codes

Since it is usual for DVD movies to be released at different times in different regions of the world, all players have region codes and disc can have an optional region code. If you load a disc of a different region code to your player, you will see the region code notice on the screen. The disc will not play, and should be unloaded. There are 6 regions (also called "locals"). Each DVD player and disc will be played in one region ONLY.



- 1 Canada, U.S., U.S. Territories
- 2 Japan, Europe, South Africa, Middle East (including Egypt)
- 3 Southeast Asia, East Asia (including Hong Kong)
- 4 Australia, New Zealand, Pacific Islands, Central America, Mexico, South America, Caribbean
- 5 Former Soviet Union, Indian Subcontinent, Africa (also North Korea, Mongolia)
- 6 China

WARNING

To reduce the risk of fire or electric shock, do not expose this apparatus to rain or moisture. The apparatus shall not be exposed to dripping or splashing and no objects filled with liquids, such as vases, shall be placed on the apparatus.

For DVD Players with 525p, but not 625p, Progressive Scan output:

CONSUMERS SHOULD NOTE THAT NOT ALL HIGH DEFINITION TELEVISION SETS ARE FULLY COMPATIBLE WITH THIS PRODUCT AND MAY CAUSE ARTIFACTS TO BE DISPLAYED IN THE PICTURE. IN CASE OF 525 PROGRESSIVE SCAN PICTURE PROBLEMS, IT IS RECOMMENDED THAT THE USER SWITCH THE CONNECTION TO THE 'STANDARD DEFINITION' OUTPUT. IF THERE ARE QUESTIONS REGARDING OUR TV SET COMPATIBILITY WITH THIS MODEL 525p DVD PLAYER, PLEASE CONTACT OUR CUSTOMER SERVICE CENTER.

Important Safety Instructions

- 1 Read these instructions.
- 2 Keep these instructions.
- 3 Heed all warnings.
- 4 Follow all instructions.
- 5 Do not use this apparatus near water.
- 6 Clean only with a damp cloth.
- 7 Do not block any of the ventilation openings. Install in accordance with the manufacturer's instructions.
- 8 Do not install near any heat sources such as radiators, heat registers, stoves, or other apparatus (including amplifiers) that produce heat.
- 9 Do not defeat the safety purpose of the polarized-type plug. A polarized plug has two blades with one wider than the other. The wide blade is provided for your safety. When the provided plug does not fit into your outlet, consult an electrician for replacement of the obsolete outlet.
- 10 Protect the power cord from being walked on or pinched particularly at plug, convenience receptacles, and the point where they exit from the apparatus.
- 11 Only use attachments/accessories specified by the manufacturer.
- 12 Use only with a cart, stand, tripod, bracket, or table specified by the manufacturer or sold with the apparatus. When a cart is used, use caution when moving the cart/apparatus combination to avoid injury from tip-over.
- 13 Unplug this apparatus during lightning storms or when unused for long periods of time.
- 14 Refer all servicing to qualified service personnel. Servicing is required when the apparatus has been damaged in any way; such as when the power-supply cord or plug is damaged, liquid has been spilled or objects have fallen into the apparatus, the apparatus has been exposed to rain or moisture, does not operate normally, or has been dropped.



PORTABLE CART WARNING
(Symbol provided by RETAC)

Power cord protection

To avoid any malfunctions of the unit, and to protect against electric shock, fire or personal injury, please observe the following:

- Hold the plug firmly when connecting or disconnecting the AC power cord.
- Keep the AC power cord away from heating appliances.
- Never put any heavy object on the AC power cord.
- Do not attempt to repair or reconstruct the AC power cord in any way.

Placement

Avoid placing the unit in areas of:

- direct sunlight or heating radiators, or closed automobiles
- high temperature (over 95°F) or high humidity (over 90%)
- significant dust as the internal parts may be seriously damaged.

Non-use periods

When the unit is not being used, turn it off. When left unused for a long period of time, the unit should be unplugged from the household AC outlet.

No fingers or other objects inside

- Touching internal parts of this unit is dangerous, and may cause serious damage to the unit. Do not attempt to disassemble the unit.
- Do not put any foreign object in the disc tray.

Keep away from water

- Keep the unit away from flower vases, tubs, sinks, etc. If liquids are spilled into the unit, serious damage could occur.

Keep away from magnets

Never bring a magnet or magnetized object near the unit.

Stacking

- Place the unit in a horizontal position, and do not place anything heavy on it.

Condensation

Moisture may form on the lens in the following conditions:

- immediately after a heater has been turned on
- in a steamy or very humid room
- when the unit is suddenly moved from a cold environment to a warm one

If moisture forms inside this unit, it may not operate properly. In this case, turn on the power and wait about one hour for the moisture to evaporate.

If there is noise interference on the TV while a broadcast is being received

Depending on the reception condition of the TV, interference may appear on the TV monitor while you watch a TV broadcast and the unit is left on. This is not a malfunction of the unit or the TV. To watch a TV broadcast, turn off the unit.

Player Overview

Front View

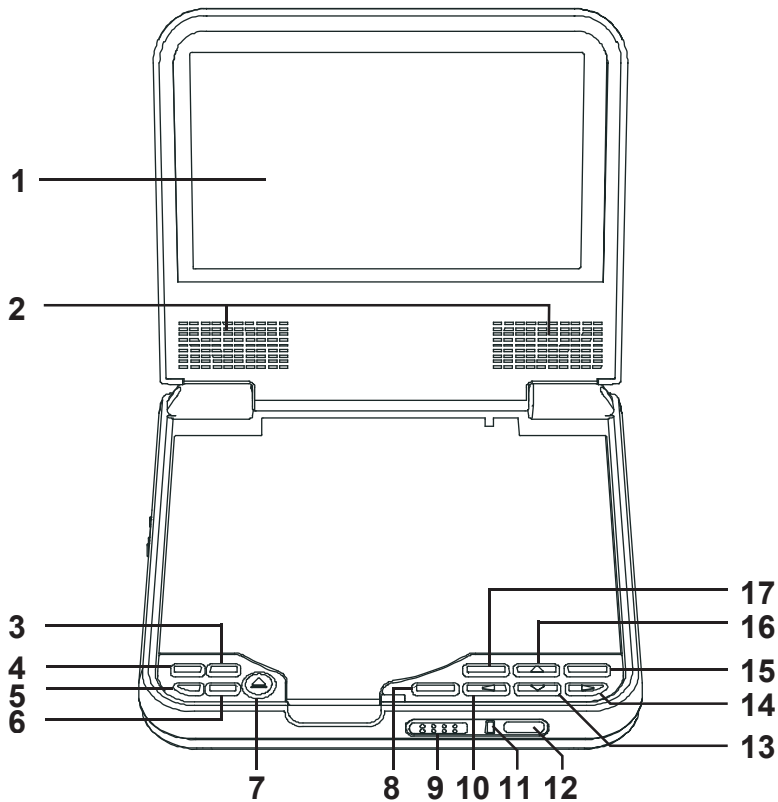

- 1 **LCD Screen**
- 2 **Built-in Speakers**
- 3 **Setup** - Displays the player's Setup menu.
- 4 **LCD** - Displays a series of options relating to the display, including Panel, Color, Brightness, Invert, and Close.
- 5 **Mode** - Switches between S-Video and Progressive Scan modes.
- 6 **Menu** - Displays the disc menu of a DVD.
- 7 **▲ Open Disc Tray** - Opens the disc tray.
- 8 **Play ►/Select** - Starts playback. Also makes selections in menus.
- 9 **Open Top Panel Latch** - Releases the player's top panel.
- 10 **◀◀ / ◀ Reverse Scan** - Scans backward at variable speed during playback. Moves left in menus.
- 11 **Power Indicator** - Lights when player is on.
- 12 **IR Sensor** - Receives input from remote control.
- 13 **■ / ▼ Stop** - Stops playback. Moves down in menus.
- 14 **▶▶ / ▶ Forward Scan** - Scans backward at variable speed during playback. Moves right in menus.
- 15 **▶▶ Skip Next** - Skips to next chapter/track during playback.
- 16 **|| / ▲ Pause** - Pauses playback. Moves up in menus.
- 17 **◀◀ Skip Previous** - Skips to previous chapter/track during playback.

Player Overview

Side Views

Left Side

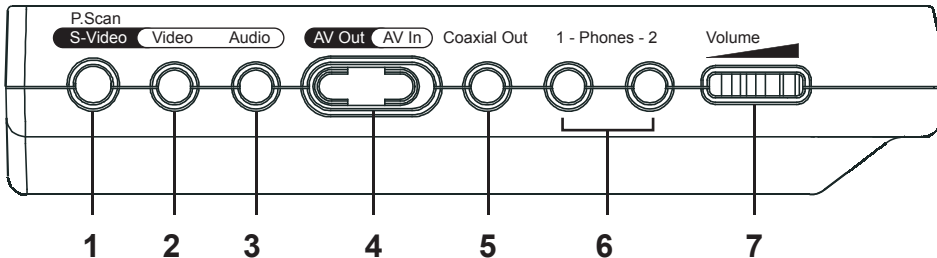

Right Side

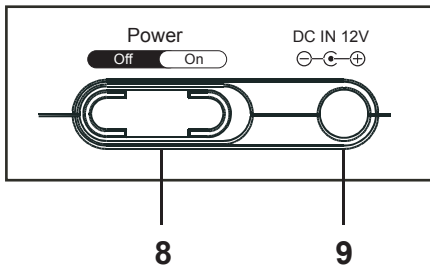

- 1 S-Video/Progressive Scan Video Output** - Connects out to a TV with S-Video or Progressive Scan inputs.
- 2 Video Output/Input** - Connects out to a TV or display device. Also connects in from an external video device, such as a camcorder or VCR.
- 3 Audio Output/Input** - Connects out to a stereo TV or analog amplifier. Also connects in from an external audio device, such as a camcorder or VCR.
- 4 AV Out/AV In Switch** - Changes the Video and Audio jacks to be either Inputs or Outputs.
- 5 Coaxial Digital Audio Output** - Connects out to a digital amplifier/receiver with a Dolby Digital or DTS decoder.
- 6 Phones 1-2 Jacks** - Connects to headphones or earphones.
- 7 Volume Control** - Adjusts the player's volume.
- 8 Power Off/On Switch** - Turns the player on and off.
- 9 DC In Jack** - Connects to the supplied AC adapter.

Player Overview

Remote Control

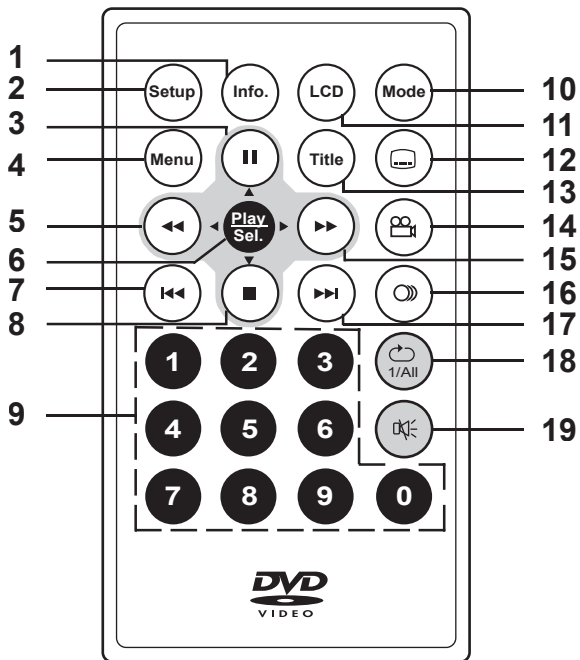

- 1 Info.** - Displays current chapter/track information.
- 2 Setup** - Displays the player's Setup menu.
- 3 || / ▲ Pause** - Pauses playback. Moves up in menus.
- 4 Menu** - Displays the disc menu of a DVD.
- 5 ◀ / ◀ Reverse Scan** - Scans backward at variable speed during playback. Moves left in menus.
- 6 Play ▶/Select** - Starts playback. Also makes selections in menus.
- 7 ◀◀ Skip Previous** - Skips to previous chapter/track during playback.
- 8 ■ / ▼ Stop** - Stops playback. Moves down in menus.
- 9 Numbers** - Makes direct selections in menus.
- 10 Mode** - Switches between S-Video and Progressive Scan modes.
- 11 LCD** - Displays a series of options relating to the display, including Panel, Color, Brightness, Invert, and Close.
- 12 ◻ Subtitle** - Selects among available DVD subtitle languages.
- 13 Title** - Displays DVD title menu, if available.
- 14 ◻ Angle** - Selects among available angles during DVD playback.
- 15 ▶▶ / ▶ Forward Scan** - Scans backward at variable speed during playback. Moves right in menus.
- 16 ◻ Audio** - Selects among available DVD audio languages.
- 17 ▶▶ Skip Next** - Skips to next chapter/track during playback.
- 18 ↻ 1/ALL** - Selects among several Repeat modes.
- 19 ◻ Mute** - Turns the sound on and off.

Inserting Remote Control Batteries

- Squeeze the release lever and pull the battery tray out of the remote control.
- Insert the supplied CR2025 3V lithium battery with the positive (+) side of the battery facing up.
- Slide the battery tray back into place.

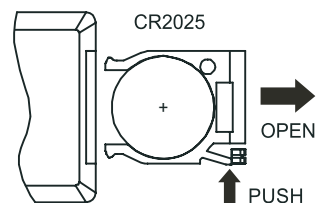

Quick Start

Step 1 - Connect AC Adapter

Connect the supplied AC adapter to the DC IN jack on the right side of the portable DVD player.

- You can also use the supplied cigarette lighter adapter in place of the AC adapter to supply power to the player.

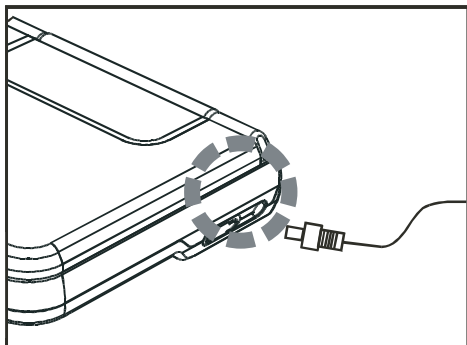

Step 2 - Connect Headphones (Optional)

You can listen to the built-in speakers, or connect headphones or earphones to the Phones 1 or 2 jacks on the left side of the player.

- To connect the unit to external equipment, such as a TV, stereo, or amplifier, see pages 10-11.

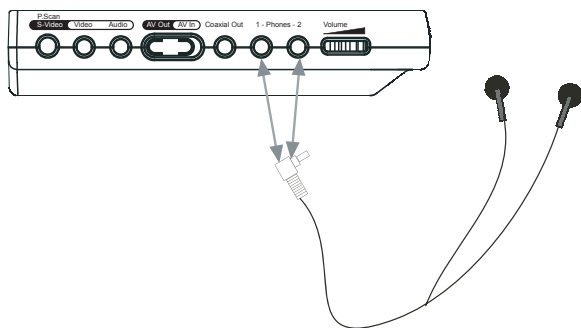

Step 3 - Open Top Panel

Slide the **Open** latch on the front of the player to release the top panel and adjust the LCD screen to the desired angle.

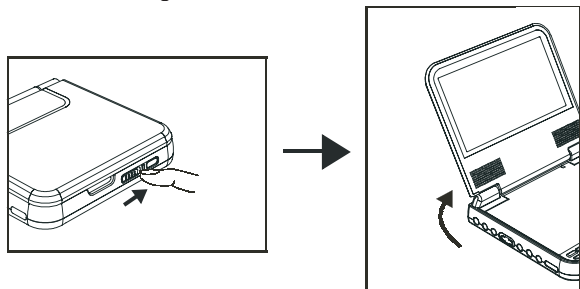

Step 4 - Turn on Power

Slide the **Power** button to the On position to turn on the player.

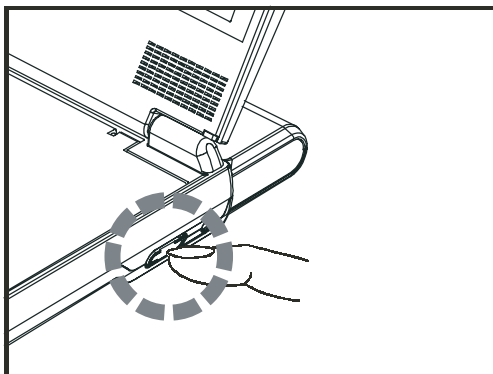

Step 5 - Open Disc Cover

Press the **Open** button to open the disc cover.

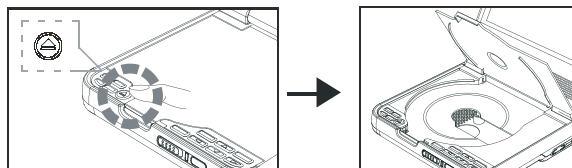

Step 6 - Insert Disc

Place the disc in the center of the tray with the label side facing up.

- Press the disk onto the spindle in the center of the tray.

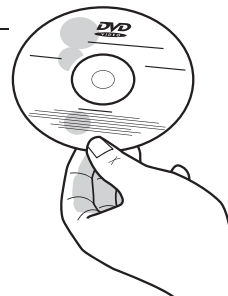

Step 7 - Close Disc Cover

Press down on the disc cover until it snaps shut.

- The disc will load automatically.

Step 8 - Play Disc

Press the **▶/Select** button to start playback of the disc.

- If a DVD disc menu appears, use the **◀/▶/▲/▼** keys to select the desired option and press **▶/Select** to confirm.

Quick Start

Battery Pack Overview

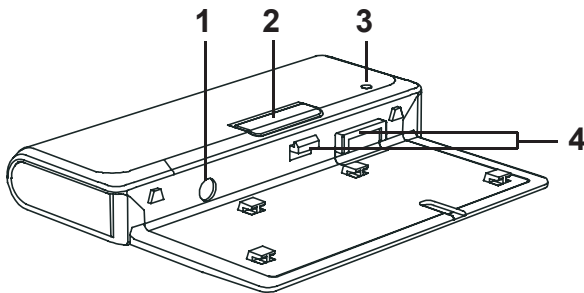

- 1 DC In Jack
- 2 Battery Release Button
- 3 Battery Charge Indicator
- 4 Battery Connectors

Charging the Battery Pack

Before using the battery pack, make sure it is fully charged. You can charge the battery pack directly or while it is attached to the portable DVD player.

Charging the Battery Pack Directly

- 1 Plug the supplied AC adapter into a standard power outlet, and then connect it to the DC IN jack on the left side of the battery pack.
 - You can also use the supplied cigarette lighter adapter in place of the AC adapter to charge the battery.

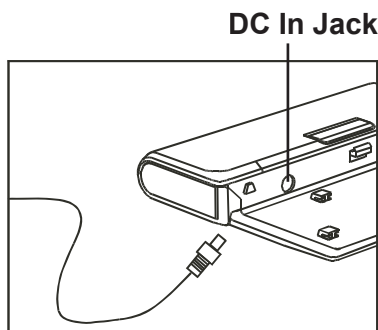

- 2 The battery charge indicator will turn red while the battery is charging.
- 3 The battery charge indicator will turn green when the battery pack is fully charged.
 - Allow ~3 hours to fully charge the battery.
 - A fully charged battery permits ~3 hours of playback time.

Charging the Battery Pack While it is Attached to the Player

- 1 Connect the battery pack to the back of the player as shown.

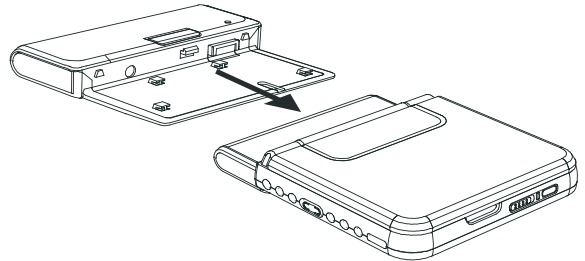

- 2 Plug the supplied AC adapter into a standard power outlet, and then connect it to the DC In jack on the right side of the player.

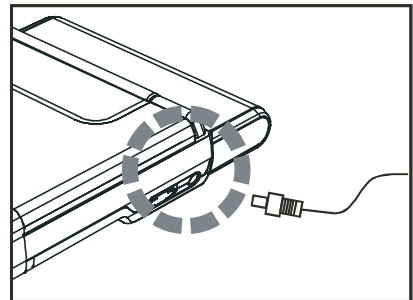

- 3 Turn off the player. The battery pack will NOT charge while the portable DVD player is powered on.
- 4 The battery charge indicator will turn red while the battery is charging.
- 5 The battery charge indicator will turn green when the battery pack is fully charged.

Removing the Battery Pack

- Press the Battery Release button on top of the battery pack to remove it.



CAUTION

- Use the specified battery pack only.
- May explode if battery pack is incorrectly replaced or disposed of in fire. Replace only with the same or equivalent type.
- Do not short circuit.
- Do not place the battery pack in direct sunlight or in excessively hot places (over 140°F (60°C) such as the dashboard of cars.
- Use only with the specified power adapter (12VDC, 1.25A).

Connections

Basic TV Connections

You can connect the portable DVD player to a standard television using the player's Audio and Video jacks.

- 1 Connect the supplied audio cable (mini-plug to RCA stereo) from the Audio jack on the left side of the player to the Audio Inputs on your television.
- 2 Connect the supplied video cable (mini-plug to RCA video) from the Video jack on the left side of the player to the Video Input on your television.
- 3 Slide the **AV Out/AV In** switch to the AV Out position.
- 4 Set your TV to its appropriate Video input to view the player.

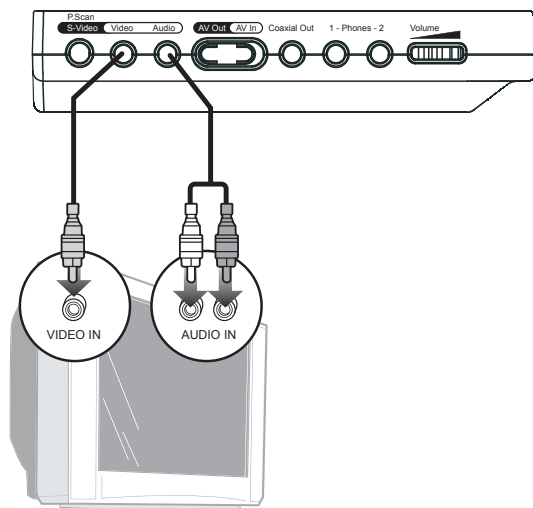

Enhanced Video Connections

For improved picture quality, you can connect the portable DVD player to a TV equipped with S-Video or Progressive Scan inputs. These connections require special cables with mini-plug adapters (not included).

S-Video Connections

- 1 Connect an S-Video cable with mini-plug adapter (not included) from the S-Video jack on the left side of the player to the S-Video input on your television.
- 2 Slide the **AV Out/AV In** switch to the AV Out position.
- 3 Set the Video Output to S-Video in the player's Screen Setup menu (see page 23).
 - You can also press the **Mode** button as a shortcut to switch between S-Video and Progressive Scan modes.
- 4 Set your TV to its S-Video input to view the player.

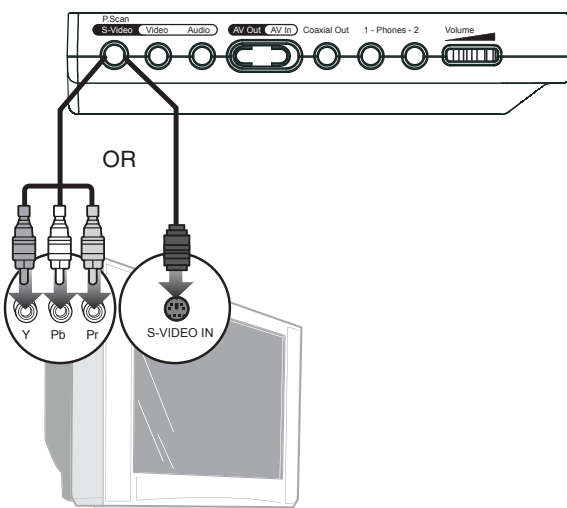

Progressive Scan/Component Video Connections

- 1 Connect a Component Video cable with mini-plug adapter (not included) from the P-Scan jack on the left side of the player to the Progressive Scan/Component Video inputs (Y, Pb, Pr) on your television.
- 2 Slide the **AV Out/AV In** switch to the AV Out position.

- 3 Set the Video Output to P-Scan in the player's Screen Setup menu (see page 23).
 - You can also press the **Mode** button as a shortcut to switch between S-Video and Progressive Scan modes.
- 4 Set your TV to its Progressive Scan input to view the player.

Connections

Enhanced Audio Connections

For enhanced audio quality, you can connect the portable DVD player to a stereo system or digital amplifier/receiver.

Analog Audio Connections

- 1 Connect the supplied audio cable (mini-plug to RCA stereo) from the AV Out jack on the left side of the player to the left and right Audio Inputs on your stereo or 2-channel analog receiver.
- 2 Slide the **AV Out/AV In** switch to the AV Out position.
- 3 Set your stereo to its appropriate input to hear the player.

Digital Audio Connections

- 1 Connect a digital coaxial cable with mini-plug adapter (not included) from the Coaxial jack on the left side of the player to the coaxial digital audio input on your digital receiver.
- 2 Set the Digital Out to SPDIF/PCM (Stereo) or SPDIF/RAW (Digital) in the player's Audio Setup menu (see page 24).
- 3 Set your receiver to its appropriate input to hear the player.

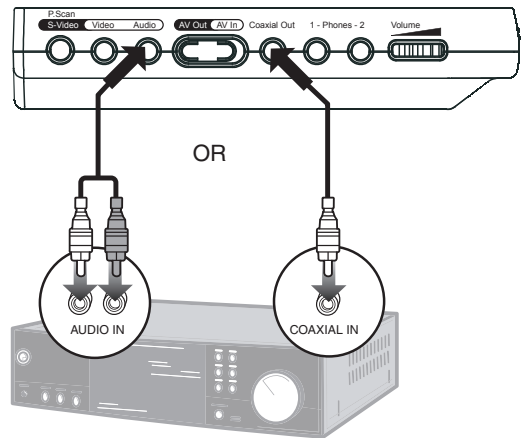

External Device Connections

You can connect an external device, such as a VCR, camcorder, or video game, to the portable DVD player.

- 1 Connect your external device to the audio/video inputs on the left side of the portable DVD player:
 - Video - Requires mini-plug to RCA video cable (included)
 - Audio - Requires mini-plug to RCA audio cable (included)
- 2 Slide the **AV Out/AV In** switch to the AV In position to view your external device.

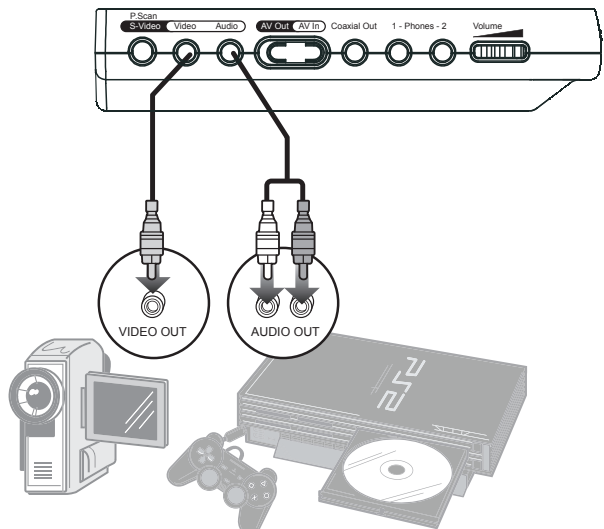

DVD Playback

Before You Begin...

Connect the portable DVD player to a power outlet and plug in headphones or listen to the built-in speakers. You can also connect the player to external equipment, such as a TV and/or audio system. If you do this, remember to:

- Turn on your TV and select the appropriate video input.
- Turn on your stereo or audio system and select the appropriate audio input.
- Slide the **AV Out/AV In** switch to the **AV OUT** position.

Basic DVD Playback

- 1 Press **Power** on.
- 2 Press **Open**  to open the disc cover.
- 3 Hold the edge of the disc and place it in the tray with the label side up.
 - Press the disk onto the spindle in the center of the tray.
- 4 Close the disc cover.
 - The portable DVD player starts playback or opens the DVD disc menu automatically.
 - Proceed with steps 5 and 6 when a menu is available on the disc.
- 5 Press **◀ / ▶ / ▲ / ▼** or use the number button(s) to select the desired chapter/title.
 - To select a chapter/title, input the number; e.g., press “1” for chapter 1, “10” for chapter 10, etc.
- 6 Press **▶ / Select**.
 - The player starts playback of the selected item.

Viewing Disc Menus

Press **Menu**. The portable DVD player stops playback, and then displays the menu screen.

When not in use...

When the portable DVD player is not in use, remove the disc and press **Power** to turn off the player. Then close the display panel.

- The disc continues to rotate while the menu is displayed even after the player has finished playing a particular disc. When no further selections are to be played, be sure to press the **■ Stop** button to clear the menu screen.
- If the disc is placed in the tray upside down (and it is a single sided disc), the “NO DISC” message will appear.

For your reference:

- When “” appears when a button is pressed, it means that the corresponding function is prohibited by the player.

Stopping Playback

- Press **■ Stop** once to stop and hold playback at the current position.
- Press **■ Stop** twice to stop and reset the disc to the beginning.

DVD Playback

Forward/Reverse Scan

Press ◀ or ▶ during playback.

- Normal playback is resumed when you press ▶ /Select.
- The Forward Scan (▶ x2, ▶ x4, etc.) and Reverse Scan (◀ x2, ◀ x4, and etc.) speed changes each time you press the ◀ / ▶ buttons.

Skip Next/Previous

You can skip to a specific chapter or track during playback.

Skipping Ahead

Press ▶▶ during playback.

- Skips a chapter each time you press the ▶▶ button.

Skipping Back

Press ◀◀ during playback.

- When you press the ◀◀ button midway through a chapter, the portable DVD player returns to the beginning of the chapter. The player then skips a chapter each time you press the ◀◀ button.

Pause

Press || once during playback.

- The screen is paused.
- To return to normal playback, press ▶ /Select.

Repeat

Press ↺ 1/All repeatedly during playback to select from the following options:

- Press once to repeat the current Chapter
- Press twice to repeat the current Title
- Press three times to repeat the current Disc
- Press four times to turn repeat Off

To return to normal playback

Press ↺ 1/All until "REPEAT Off" appears.

- Repeat playback works only with discs for which the elapsed playing time appears on the player's display during playback.
- Repeat playback may not work correctly with some DVDs.

Special DVD Features

Displaying Scene Information

Press **Info.** during playback.



- Press **Info.** repeatedly to display the title number, chapter number, and other information on the screen.

Stop Displaying Scene Information

- Press **Info.** repeatedly until the scene information disappears.

Audio

You can change the audio sound track to any available language on the disc.





- 1 Press  **Audio** during playback.
- 2 Press  **Audio** repeatedly until the preferred language is selected.

For your reference:

- When the preferred language is not selected even after pressing the button several times, it may indicate that language is not available on the disc.
- When you load or remove the disc, the portable DVD player will search for the Audio language selected in the Setup Menu. If your preferred language is not available on the disc, the portable DVD player will playback the disc's default language.

Subtitles

If a disc provides subtitles, you can choose to hide or display them. This operation works only with discs that provide subtitles.

- 1 Press  **Subtitle** during playback.
 - When you press  **Subtitle** once, the first subtitle language recorded on the disc will be displayed. The rest of the subtitles recorded will display in sequence as you press the button.
 - If no subtitles are recorded “” will display instead of the language number.
- 2 Press  **Subtitle** repeatedly until the preferred language is selected.
 - You can change to another language with this function, or you can clear the subtitles by pressing this button repeatedly until “SUBTITLE OFF” appears on the screen.
 - In some cases, the subtitle language may not change immediately to the selected one.



For your reference:

- When the preferred subtitle language is not selected even after pressing the button several times, it may indicate that the language is not available on the disc.
- When you load or remove the disc, the portable DVD player will search for the Subtitle language selected in the Setup Menu. If your preferred language is not available on the disc, the portable DVD player will playback the disc's default language.

Special DVD Features

Angle

Some DVD discs contain scenes which have been shot simultaneously from a number of different angles. Use the  **ANGLE** button to view these alternative scenes.

- 1 Press  **ANGLE** during playback.
- 2 Press  **ANGLE** repeatedly until the preferred viewing angle is selected.
 - ANGLE will only function on discs where different angles have been recorded.





Mute

To mute the volume on the portable DVD player.

- 1 Press  **MUTE** during playback.
 - To resume normal sound, press MUTE repeatedly until "MUTE OFF" appears on the screen.





Title

Some DVDs have Title menus, which allow you to choose among multiple titles (usually movies).

- 1 Press **TITLE** in stop mode
 - The Title menu appears, if available.
- 2 Press  /  /  /  to select the preferred item.
- 3 Press  / **Select**.

Disc Menu

Most DVDs have disc menus, which include special disc features, including audio languages, subtitle languages and more.

- 1 Press  / **Select**.
- 2 Press **Menu**.
 - The Disc menu appears, if available.
- 3 Press  /  /  /  or use the number button(s) to select the preferred item.
 - Menu details vary by disc.

Other Disc Playback

Playing Audio CDs

Before You Begin...

Connect the portable DVD player to a power outlet and plug in headphones or listen to the built-in speakers. You can also connect the player to external equipment, such as a TV and/or audio system. If you do this, remember to:

- Turn on your TV and select the appropriate video input.
- Turn on your stereo or audio system and select the appropriate audio input.
- Slide the **AV Out/AV In** switch to the AV Out position.

Basic Audio CD Playback

- 1 Press **Power** on.
- 2 Press **Open**  to open the disc cover.
- 3 Hold the edge of the disc and place it in the tray with the label side up.
 - Press the disk onto the spindle in the center of the tray.
- 4 Close the disc cover.
 - Standard CDs start playing automatically.
 - If the CD has playback control, the CD disc menu will appear.

Stopping Playback

- Press **■ Stop** once to stop and hold playback at the current position.
- Press **■ Stop** twice to stop and reset the disc to the beginning.

Forward/Reverse Scan

Press **◀** or **▶** during playback.

- Normal playback is resumed when you press **▶/Select**.
- The Forward Scan (**▶** x2, **▶** x4, etc.) and Reverse Scan (**◀** x2, **◀** x4, etc.) speed changes each time you press the **◀/▶** buttons.

Skipping Ahead

Press **▶▶** during playback.

- Skips a track each time you press the **▶▶** button.

Skipping Back

- Press **◀◀** during playback.
- When you press the **◀◀** button midway through a track, the portable DVD player returns to the beginning of the track. The player then skips a track each time you press the **◀◀** button.

Pause

Press **|| Pause** once during playback.

- Playback is paused.

To return to normal playback

Press **▶/Select**.

Displaying Track Information

Press **Info.** during playback.

- Press **Info.** repeatedly to display the elapsed time, track number, and other information on the screen.

Stop Displaying Track Information

- Press **Info.** repeatedly until the track information disappears.

Other Disc Playback

Playing Kodak Picture CDs

You can play Kodak Picture CDs in your portable DVD player.

Basic Playback

- 1 Load a Kodak Picture CD.
 - After a few seconds, the portable DVD player starts a slide show of available images.
- 2 Press **Info.** to view the current image number and total number of images.
- 3 Use the number keys to jump to a specific image.
 - The portable DVD player will begin the slide show from the selected image.
 - Press **II Pause** to pause the slide show.
 - Press **■ Stop** to stop the slide show and enter Thumbnail mode.

Playback Modes

There are four modes while playing a Kodak Picture CD:

- Thumbnail Mode
- Rotate Mode
- Play Mode
- Program Mode

Thumbnail Mode

Thumbnail mode allows you to view thumbnails of up to 15 images at a time.

- 1 Press **■ Stop** to stop the slide show.
- 2 Press **◀ / ▶ / ▲ / ▼** to select "Return" then press **▶ / Select.**
- 3 Press **◀◀** and **▶▶** to view the previous or next page of thumbnail images.
- 4 Press **◀ / ▶ / ▲ / ▼** to choose the desired image.
- 5 Press **▶ / Select** to see the full size image and start the slide show.

Rotate Mode

You can rotate your images clockwise in 90 degree increments.

- 1 Press **■ Stop** to stop the slide show.
- 2 Press **◀ / ▶ / ▲ / ▼** to select "Rotate" then press **▶ / Select.**
- 3 Press **◀◀** and **▶▶** to view the desired page of thumbnail images.
- 4 Press **◀ / ▶ / ▲ / ▼** to choose the desired image.
- 5 Press **▶ / Select** repeatedly to rotate the image clockwise in 90 degree increments.
 - To restore all rotated images to their original state, choose "Reset" and press **▶ / Select.**

Play Mode

Play mode allows you to view your images in a slide show.

- 1 Press **◀ / ▶** to select the Play icon (**▶**), then press **▶ / Select.**
- 2 The slide show starts playing from the current image.
 - Press **◀◀** and **▶▶** to view the previous or next image.
 - Press **◀ / ▶** to rotate the current image in 90 degree increments.
 - Press **II Pause** to pause the slide show.
 - Press **▶ / Select** to resume the slide show.
 - Press **■ Stop** to return to Thumbnail mode.

Program Mode

Program mode allows you to create a custom slide show.

- 1 Press **■ Stop** to stop the slide show.
- 2 Press **◀ / ▶ / ▲ / ▼** to select "Program" then press **▶ / Select.**
- 3 Press **◀ / ▶ / ▲ / ▼** to highlight the desired images, then press **▶ / Select** to mark them with a yellow box and add them to your Program List.
- 4 Press **◀ / ▶ / ▲ / ▼** to choose "Program List", then press **▶ / Select.**
 - The Program List menu appears with thumbnails of all your marked images.
- 5 Press **◀ / ▶ / ▲ / ▼** to choose the Play icon (**▶**), then press **▶ / Select** to play the programmed images.

To delete an image from the programmed list

- Press **◀ / ▶ / ▲ / ▼** to choose the image, then press **▶ / Select.**

To delete all images from the programmed list

- Select "Clear all" and press **▶ / Select.**

To exit the programmed list

- Press **◀ / ▶** to choose "Return", then press **▶ / Select.**

To exit program mode.

- Press **◀ / ▶** to choose "Return" again, then press **▶ / Select.**

Other Disc Playback

Playing JPEG Picture CDs

You can play JPEG picture CDs in your portable DVD player.

Basic Playback

- 1 Load a JPEG Picture CD.
 - After a few seconds, the portable DVD player starts a slide show of available images.
- 2 Press **Info.** to view the current image number and total number of images.
- 3 Use the number keys to jump to a specific image.
 - The portable DVD player will begin the slide show from the selected image.
 - Press **II Pause** to pause the slide show.
 - Press **■ Stop** to stop the slide show and enter File Manager mode.

Playback Modes

There are four modes while playing a JPEG Picture CD:

- File Manager Mode
- Play Mode
- Program Mode
- Thumbnail Mode

To enter these modes:

- 1 Press **■ Stop**.
- 2 Press **◀ / ▶** to select the desired mode.
- 3 Press **▶ / Select** to enter the selected mode.

File Manager Mode

File Manager mode allows you to view your images in a directory format.

- Press **◀ / ▶ / ▲ / ▼** to choose the desired image, then press **▶ / Select** to display the image.
- Press **◀◀** and **▶▶** to view the previous or next 6 images in the list.

Play Mode

Play mode allows you to view your images in a slide show.

- Press **◀◀** and **▶▶** to view the previous or next image.
- Press **◀ / ▶** to rotate the image in 90 degree increments.
- Press **II Pause** to pause the slide show.
- Press **▶ / Select** to resume the slide show.
- Press **■ Stop** to return to File Manager mode.

Program Mode

Program mode allows you to create a custom slide show.

- 1 Press **◀ / ▶ / ▲ / ▼** to highlight the desired images, then press **▶ / Select** to mark them with a yellow box and add them to your Program List.
- 2 Press **◀ / ▶** to choose "Program List", then press **▶ / Select**.
 - The Program List menu appears with a list of all of your marked images.
- 3 Press **◀ / ▶** to choose the Play icon (**▶**), then press **▶ / Select** to play the programmed files.

To delete a file from the programmed list

- Press **▲ / ▼** to choose the file, then press **▶ / Select**.

To delete all files from the programmed list

- Select "Clear all" and press **▶ / Select**.

To exit the programmed list

- Press **◀ / ▶** to choose "Return", then press **▶ / Select**.

To exit program mode.

- Press **◀ / ▶** to choose "Return" again, then press **▶ / Select**.

Thumbnail Mode

Thumbnail mode allows you to view thumbnails of up to 15 images at a time.

- Press **◀ / ▶ / ▲ / ▼** to choose the desired image, then press **▶ / Select** to see the full size image and start the slide show.
- Press **◀◀** and **▶▶** to view the previous or next page of thumbnail images.
- To rotate an image, first select it, then choose "Rotate" and press **▶ / Select**. To restore all rotated images to their original state, choose "Reset" and press **▶ / Select**.













Other Disc Playback

Playing MP3 CDs

- 1 Press **Power** on.
- 2 Press **Open**  to open the disc cover.
- 3 Hold the edge of the MP3 disc and place it in the tray with the label side up.
 - Press the disc onto the spindle in the center of the tray.
- 4 Close the disc cover.
 - After a few moments, the first MP3 file in the disc's root directory will start playing automatically.

Browsing Directories

MP3 discs are often divided into directories (i.e., folders) which are subdivided into MP3 tracks. If your disc contains directories:

- 1 Press **Stop**  to stop playback.
- 2 Press  /  /  /  to choose the desired directory, then press **Select**  to open it.
- 3 Press  /  /  /  to choose the desired track, then press **Select**  to start playback.
 - You can also enter a track number directly with the number buttons, then press **Select**  to start playback.

To stop playback

- Press **Stop** .

To skip to the previous/next track.

- Press  /  during playback.

To pause playback

















- Press **Pause** .

To resume playback



- Press **Select** .

Programming MP3 CDs

Program mode allows you to create a custom play list.

- 1 Press **Stop**  to stop playback.
- 2 Press  /  to select "Program", then press **Select** .
- 3 Press  /  /  /  to highlight the desired tracks, then press **Select**  to mark them with a yellow box and add them to your Program List.
- 4 Press  /  to choose "Program List", then press **Select** .
- The Program List menu appears with a list of all of your marked tracks.
- 5 Press  /  to choose the Play icon (), then press **Select**  to play the programmed files.



To delete a track from the programmed list

- Press  /  to choose the track, then press **Select** .



To delete all tracks from the programmed list

- Select "Clear all" and press **Select** .

To exit the programmed list

- Press  /  to choose "Return", then press **Select** .

To exit program mode.

- Press  /  to choose "Return" again, then press **Select** .

Playing CDs with MP3 and JPEG files

The portable DVD player will play CDs with MP3 and JPEG files. The operations are the same as with standard MP3 and JPEG discs.

Language Setup

On Screen Display (OSD) Language

You can select among various languages for the player's on-screen display (OSD).

- 1 Press **Setup** in Stop mode.
- 2 Press **▲/▼** to select "Language Setup", then press **▶/Select**.
- 3 Press **▲/▼** to select "OSD", then press **▶/Select**.

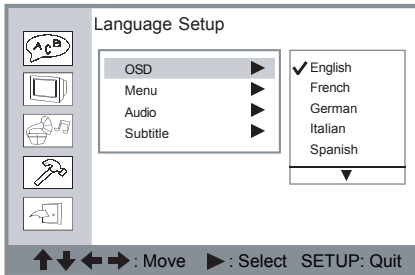

- 4 Press **▲/▼** to select your preferred language.
- 5 Press **▶/Select**.

To return to the Setup menu

Press **◀**.

To exit the Setup menu

Press **Setup** or select "Exit Setup" on the Setup Menu screen.

Disc Menu Language

You can select your preferred language for DVD disc menus.

- 1 Press **Setup** in Stop mode.
- 2 Press **▲/▼** to select "Language Setup", then press **▶/Select**.
- 3 Press **▲/▼** to select "Menu", then press **▶/Select**.

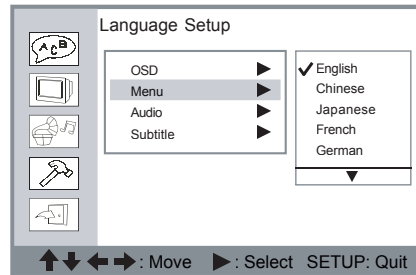

- 4 Press **▲/▼** to select your preferred language.
- 5 Press **▶/Select**.

To return to the Setup menu

Press **◀**.

To exit the Setup menu

Press **Setup** or select "Exit Setup" on the Setup Menu screen.

Language Setup

Audio Language [DVD]

You can select your preferred language for DVD audio sound tracks.

- 1 Press **Setup** in Stop mode.
- 2 Press **▲/▼** to select “Language Setup”, then press **▶/Select**.
- 3 Press **▲/▼** to select “Audio”, then press **▶/Select**.

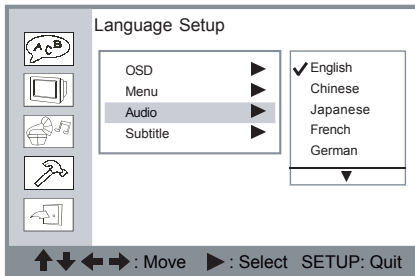

- 4 Press **▲/▼** to select your preferred language.
 - Select “Original” if you want the default language to always be played first.
- 5 Press **▶/Select**.
 - If the language selected is not recorded on the disc, the DVD player will playback the disc’s default language.

To return to the Setup menu

Press **◀**.

To exit the Setup menu

Press **Setup** or select “Exit Setup” on the Setup Menu screen.

Subtitle Language [DVD]

You can select your preferred language for DVD subtitles.

- 1 Press **Setup** in Stop mode.
- 2 Press **▲/▼** to select “Language Setup”, then press **▶/Select**.
- 3 Press **▲/▼** to select “Subtitle”, then press **▶/Select**.

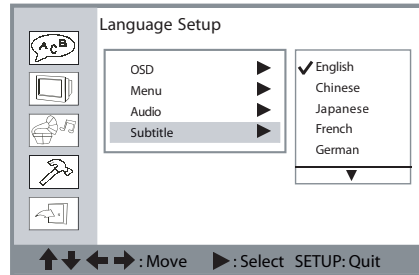

- 4 Press **▲/▼** to select your preferred language.
 - If the selected language is not available on the disc, the player will select the disc’s default language.
- 5 Press **▶/Select**.

To return to the Setup menu

Press **◀**.

To exit the Setup menu

Press **Setup** or select “Exit Setup” on the Setup Menu screen.

Screen Setup

TV Type

The TV Type feature allows you to set your preferred aspect ratio for DVD movies. Choose from the following:

- 4:3 PS (Pan & Scan) - Crops widescreen movies to fit a standard television.
- 4:3 LB (Letterbox) - Shows the full width of widescreen movies on a standard television with black bars above and below the picture.
- 16:9 - Select if you have a widescreen television.

- 1 Press **Setup**.
- 2 Press **▲ / ▼** to select "Screen Setup", then press **► / Select**.
- 3 Press **▲ / ▼** to select "TV Type", then press **► / Select**.

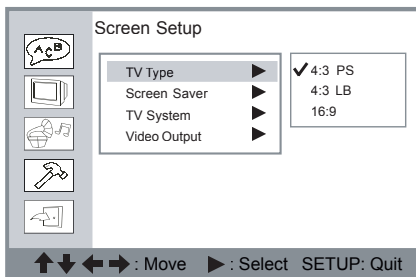

- 4 Press **▲ / ▼** to select your preferred TV Type setting.
- 5 Press **► / Select**.

To return to the Setup menu

Press **◀**.

To exit the Setup menu

Press **Setup** or select "Exit Setup" on the Setup Menu screen.

Screen Saver

The Screen Saver comes on automatically to protect the LCD screen if the player is left in Stop mode for 10 or more minutes.

- 1 Press **Setup**.
- 2 Press **▲ / ▼** to select "Screen Setup", then press **► / Select**.
- 3 Press **▲ / ▼** to select "Screen Saver", then press **► / Select**.

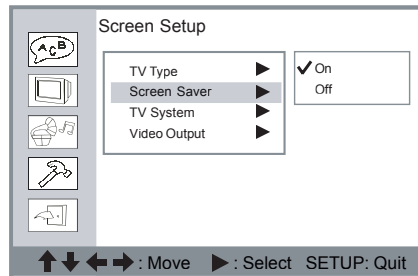

- 4 Press **▲ / ▼** to select "On" or "Off".
- 5 Press **► / Select**.

To return to the Setup menu

Press **◀**.

To exit the Setup menu

Press **Setup** or select "Exit Setup" on the Setup Menu screen.

Screen Setup

TV System

When connecting the portable DVD player to a TV, you must specify the broadcast system of your television. Choose from the following:

- NTSC - The color TV broadcast standard for the USA, Canada, Latin America and Taiwan.
- PAL - The color television broadcast standard for Western Europe (except France, where SECAM is the standard), Australia, China, Singapore and Malaysia.
- AUTO - Select if you have a multi-system TV that supports both NTSC and PAL.

- 1 Press **Setup**.
- 2 Press **▲/▼** to select "Screen Setup", then press **►/Select**.
- 3 Press **▲/▼** to select "TV System", then press **►/Select**.

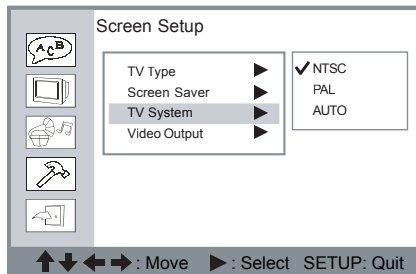

- 4 Press **▲/▼** to select the appropriate TV System setting for your television.
- 5 Press **►/Select**.

To return to the Setup menu

Press **◀**.

To exit the Setup menu

Press **Setup** or select "Exit Setup" on the Setup Menu screen.

Video Output

If you are using the S-Video/Progressive Scan video output to connect the portable DVD player to your TV, you must specify which connection you are using (S-Video or P-SCAN).

- Before you select P-SCAN, make sure your TV supports Progressive Scan and that the Y, Pb, and Pr cables are properly connected.
- If your screen turns black after adjusting this setting, press the **Mode** button to switch back to S-Video mode.

- 1 Press **Setup**.
- 2 Press **▲/▼** to select "Screen Setup", then press **►/Select**.
- 3 Press **▲/▼** to select "Video Output", then press **►/Select**.

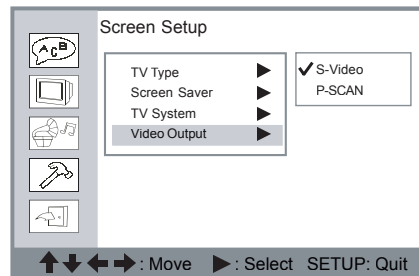

- 4 Press **▲/▼** to select the appropriate Video Output setting for your television.
- 5 Press **►/Select**.
- If you selected P-SCAN, you will be prompted to confirm that your TV supports Progressive Scan. Press **►/Select** to continue, or **■ Stop** to cancel.

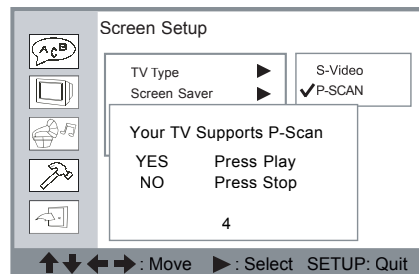

To return to the Setup menu

Press **◀**.

To exit the Setup menu

Press **Setup** or select "Exit Setup" on the Setup Menu screen.

Audio Setup

Digital Audio Output [DVD]

The digital audio output jack (labeled “Coaxial”) is used to output the audio signal recorded on DVD discs to an external amplifier/receiver. The player provides three options for this audio signal:

- SPDIF/PCM - Select if you are using a 2-channel digital amplifier.
- SPDIF/RAW - Select if you are using a Dolby Digital 5.1 or DTS capable amplifier.
- Off - Select if you are not using the Coaxial audio output.

- 1 Press **Setup** in Stop mode.
- 2 Press **▲/▼** to select “Audio Setup”, then press **▶/Select**.
- 3 Press **▲/▼** to select “Digital Out”, then press **▶/Select**.

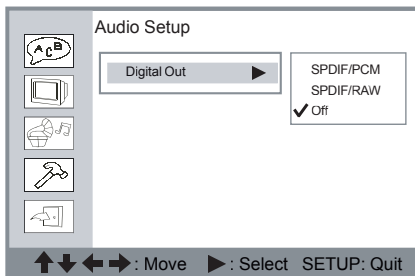

- 4 Press **▲/▼** to select your preferred Digital Out setting.
- 5 Press **▶/Select**.

WARNING:

- Do not set “Digital Out” to “SPDIF/RAW” unless you are connecting the player to an A/V amplifier/receiver with Dolby Digital (AC-3) decoding capability.
- High volume sound may damage your hearing as well as the speakers.

To return to the Setup menu

Press **◀**.

To exit the Setup menu

Press **Setup** or select “Exit Setup” on the Setup Menu screen.

Custom Setup

Parental Control [DVD]

The Parental Control feature enables you to block playback of movies based on their rating. For example, if you set the rating level to PG-13, the player will block playback of movies rated PG-13, R, NC-17 and X unless the correct password is entered.

- You can only use the Parental Control feature with rated DVD discs.

- Press **Setup** in Stop mode.
 - You must remove any disc loaded in the player to change the Parental Control setting.
- Press **▲ / ▼** to select "Custom Setup", then press **► / Select**.
- Press **▲ / ▼** to select "Parental Ctrl", then press **► / Select**.

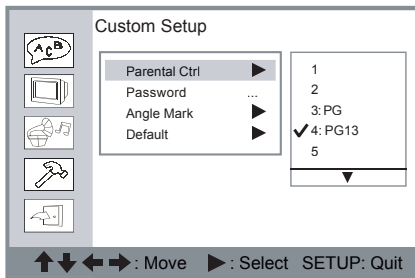

- Enter a 4-digit password, then press **► / Select**.
 - The factory pre-set password is "0000".
 - You must enter "0000" to set the rating for the first time when purchasing your DVD from the store.
- Press **▲ / ▼** to select the desired rating and press **► / Select**.

To return to the Setup menu

Press **◀**.

To exit the Setup menu

Press **Setup** or select "Exit Setup" on the Setup Menu screen.

Change Password [DVD]

To change the Parental Control password:

- Press **Setup** in Stop mode.
- Press **▲ / ▼** to select "Custom Setup", then press **► / Select**.
- Press **▲ / ▼** to select "Password", then press **► / Select**.

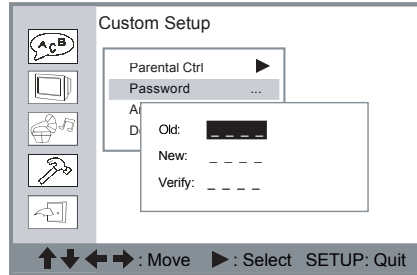

- Enter your old password, then press **► / Select**.
 - The factory pre-set password is "0000".
- Enter your new password, then press **► / Select**.
- Re-enter your new password to verify it, then press **► / Select**.

To return to the Setup menu

Press **◀**.

To exit the Setup menu

Press **Setup** or select "Exit Setup" on the Setup Menu screen.

Custom Setup

Angle Mark [DVD]

Some DVDs feature scenes filmed at different angles, which you can select by pressing the **ANGLE** button. You can have the player alert you when multiple angles are available by displaying an Angle Mark () on screen.

- Whether Angle Mark is set to On or Off, pressing the **ANGLE** button will always allow selection of multiple angles if they are available.

- 1 Press **Setup** in Stop mode.
- 2 Press **▲ / ▼** to select “Custom Setup”, then press **▶ / Select**.
- 3 Press **▲ / ▼** to select “Angle Mark”, then press **▶ / Select**.

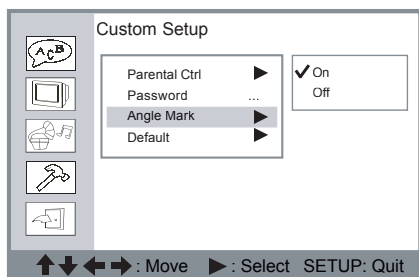

- 4 Press **▲ / ▼** to select “On” or “Off”, then press **▶ / Select**.

To return to the Setup menu

Press **◀**.

To exit the Setup menu

Press **Setup** or select “Exit Setup” on the Setup Menu screen.

Restore Defaults

Select “Default” to restore the portable DVD player to its factory default settings.

- 1 Press **Setup** in Stop mode.
- 2 Press **▲ / ▼** to select “Custom Setup”, then press **▶ / Select**.
- 3 Press **▲ / ▼** to select “Default”, then press **▶ / Select**.
 - “READ” will be highlighted.

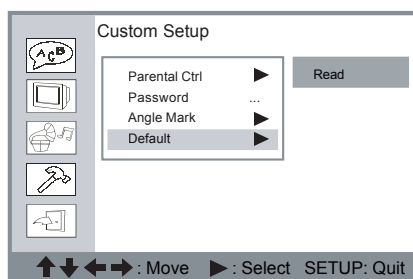

- 4 Press **▶ / Select**.
 - The player’s factory settings will be restored.
 - The Parental Control rating and Password settings will NOT be changed.

To return to the Setup menu

Press **◀**.

To exit the Setup menu

Press **Setup** or select “Exit Setup” on the Setup Menu screen.

LCD Setup

The **LCD** button provides a shortcut to five common screen adjustments.

Panel

- 1 Press **LCD** repeatedly to select Panel.
- 2 Use the ◀ / ▶ buttons to select from the following:
 - Normal - Stretches the on-screen image to fill the screen.
 - 16:9 - Sets the image to the standard widescreen aspect ratio.
 - 4:3 - Sets the image to the standard TV aspect ratio.

Panel: ◀ Normal ▶

Panel: ◀ 16:9 ▶

Panel: ◀ 4:3 ▶

Color

- 1 Press **LCD** repeatedly to select Color.
- 2 Use the ◀ / ▶ buttons to decrease or increase color saturation from -3 to +3.

Color: ◀ +3 ▶

Color: ◀ +2 ▶

Color: ◀ +1 ▶

Color: ◀ 0 ▶

Color: ◀ -1 ▶

Color: ◀ -2 ▶

Color: ◀ -3 ▶

Brightness

- 1 Press **LCD** repeatedly to select Bright.
- 2 Use the ◀ / ▶ buttons to decrease or increase screen brightness from -3 to +3.

Bright: ◀ +3 ▶

Bright: ◀ +2 ▶

Bright: ◀ +1 ▶

Bright: ◀ 0 ▶

Bright: ◀ -1 ▶

Bright: ◀ -2 ▶

Bright: ◀ -3 ▶

Invert

- 1 Press **LCD** repeatedly to select Invert.
- 2 Use the ◀ / ▶ buttons to turn Invert On or Off.
 - Use this feature to flip the screen when mounting the player on the ceiling; e.g., in a car or minivan.

Invert: ◀ Off ▶

◀ On ▶ Invert:

Close

- 1 Press **LCD** repeatedly to select Close .
- 2 Use the ◀ / ▶ buttons to turn select On or Off.
 - Use this feature to turn off the LCD screen to preserve battery life; e.g., while listening to a CD or MP3 disc. The audio will still be heard but there will be no picture on the screen.
 - When Close is set to "On", the screen will go black and the Power Indicator will blink on the front of the player.
 - To restore normal viewing, press **LCD** again.

Close: ◀ Off ▶

Close: ◀ On ▶

Troubleshooting

Before requesting service for the portable DVD player, check the chart below for a possible cause of the problem you are experiencing. Some simple checkups or a minor adjustment on your part may eliminate the problem and restore proper operation.*

SYMPTOM	REMEDY
No power.	<ul style="list-style-type: none"> • Insert AC adapter plug securely into power outlet. • Check if Power button on right side of player is pressed in. • Check power at AC outlet by testing another appliance.
Player does not start playback when PLAY is pressed.	<ul style="list-style-type: none"> • Condensation has formed: wait ~1-2 hours to allow player to dry out. • Player cannot play discs other than DVDs, Audio CDs, MP3 CDs, and Photo CDs. • Check if disc is defective by trying another disc. • Check region (local) code.
Player starts playback but stops immediately.	<ul style="list-style-type: none"> • Disc may be dirty and may require cleaning. • Ensure that disc is installed with label side up.
No picture.	<ul style="list-style-type: none"> • Ensure that equipment is connected properly. • Ensure that input setting for TV is set correctly. • Check if external equipment is on. • Select same channel and source on TV as on player. • Check if LCD is on.
No sound.	<ul style="list-style-type: none"> • Ensure that equipment is connected properly. • If using a HiFi amplifier, try another audio source. • Check Volume adjustment.
Distorted sound.	<ul style="list-style-type: none"> • Ensure that input settings for your TV and stereo system are correct. • No sound is heard during Pause mode.
No audio from Digital Output.	<ul style="list-style-type: none"> • Check digital connections. • Check Audio Setup menu to make sure that "SPDIF/RAW" or "SPDIF/PCM" is selected. • Check if the audio format of the selected audio language matches your receiver capabilities.
Distorted picture.	<ul style="list-style-type: none"> • Check disc for fingerprints and clean with a soft cloth, wiping from center to edge. • Sometimes a small amount of picture distortion may appear. This is not a malfunction.
Completely distorted picture or no color in picture.	<ul style="list-style-type: none"> • Disc format does not match TV format (PAL/NTSC).
Picture distorted during forward or reverse scan.	<ul style="list-style-type: none"> • Picture will be somewhat distorted at times. This is normal.
No forward or reverse scan playback.	<ul style="list-style-type: none"> • Some discs may have sections which prohibit Forward/Reverse Scan.
No 4:3 (16:9) picture.	<ul style="list-style-type: none"> • Choose the correct "TV Type" setting in the Setup menu.
Remote control does not function.	<ul style="list-style-type: none"> • Make sure battery is installed with correct polarities (+ and -). • Battery is depleted: replace with new one. • Point remote control at signal sensor. • Operate remote control within 20 feet of signal sensor. • Remove obstacles between remote control and signal sensor.
DVD player and remote control keys not functioning.	<ul style="list-style-type: none"> • Power unit off and on. Alternatively, turn off unit, unplug power cable and plug it back in. (Player may not be operating properly due to lightning, static electricity or some other external factor.)
Playback does not start when Title is selected.	<ul style="list-style-type: none"> • Parental Control function may be set. Confirm the "Parental Ctrl" setup.
Audio sound track and/or subtitle language not selected.	<ul style="list-style-type: none"> • If audio sound track and/or subtitle language are not available on the disc, language selected in Setup menu will not be seen/heard.
No subtitles.	<ul style="list-style-type: none"> • Subtitles not available on all discs. • Subtitles are available but turned off. Press Subtitle to display the subtitles.
Alternative audio sound track (or subtitle) languages cannot be selected.	<ul style="list-style-type: none"> • Only one language is available.
Angle cannot change.	<ul style="list-style-type: none"> • Depends on software availability. Even if a disc has a number of angles recorded, these angles may be recorded for specific scenes only.

Disc Handling & Maintenance

Handling Precautions

- Hold the disc by the edges so the surface will not be soiled with fingerprints.
- Fingerprints, dirt and scratches can cause skipping and distortion.
- Do not write on the label side with a ball-point pen or other writing utensil.
- Do not use record cleaning sprays, benzine, thinner, static electricity prevention liquids, or any other solvent.
- Be careful not to drop or bend the disc.
- Do not install more than one disc on the disc tray.
- Do not try to close the disc cover when the disc is not installed properly.
- Be sure to store the disc in its original case when not in use.

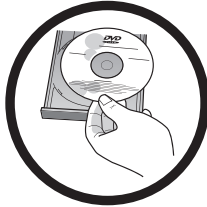

If the surface is soiled

- Wipe gently with a soft, damp (water only) cloth.
- When wiping discs, always move the cloth from the center hole toward the outer edge. (If you wipe the disc using a circular motion, circular scratches are likely to occur, which will cause noise.)

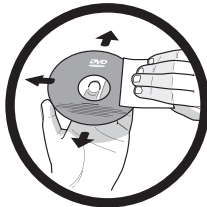

If the disc is brought from a cold to a warm environment, moisture may form on the disc

- Wipe moisture off with a soft, dry, lint-free cloth before using the disc.

Improper disc storage

You can damage discs if you store them in the following places:

- Areas exposed to direct sunlight
- Humid or dusty areas
- Areas directly exposed to a heat outlet or heating appliance

Disc which cannot be played with this player

- CD-ROM (Application Program)
- CVD
- CD-G
- DVD with a Region Code other than that shown on the DVD unit's Region Code Label on the rear panel

Maintenance

- Be sure to turn the unit off and disconnect the AC power cord before maintaining the unit.
- Wipe this unit with a dry soft cloth. If the surfaces are extremely dirty, wipe clean with a cloth which has been dipped in a weak soap-and-water solution and wrung out thoroughly, and then wipe again with a dry cloth.
- Never use alcohol, benzine, thinner, cleaning fluid or other chemicals. And do not use compressed air to remove dust.

Parts & Accessories

A number of replacement parts and optional accessories are available for this portable DVD player. To order any of the items below, please contact the GoVideo Parts department at:

- 800-736-7679, option 8
- or via e-mail at: parts@govideo.com

ITEM	DESCRIPTION	PART NUMBER
Rechargeable NiMH Battery Pack	NiMH 3800mAh (~2.7 hour DVD playback time)	92-161-07020
Rechargeable Li-ion Battery Pack (optional)	Li-ion 4000mAh (~3 hour DVD playback time)	92-161-07010
Rechargeable Li-ion Battery Pack (optional)	Li-ion 6600mAh (~5 hour DVD playback time)	92-135-43080
Universal AC/DC Power Adapter	100-240V, 12V/1.25A adapter	43-111-00077
Cigarette Lighter Adapter	12V car cigarette lighter adapter	54-201-00047
Remote Control	Credit card-size remote with 3V battery	Call for Part No.
Audio Cable	Mini-plug to red/white RCA connectors	54-201-00044
Video Cable	Mini-plug to yellow RCA connector	54-201-00045
Carrying Case	Viewable carrying case	86-135-04010
Earphones	Stereo earphones	54-401-00015
S-Video Cable	Mini-plug to S-Connector	54-201-00020
Progressive Scan Component Video Cable	Mini-plug to red/green/blue RCA connectors.	54-201-00046

Included Accessories

The following items are included with your portable DVD player:

- Rechargeable NiMH Battery Pack
- Universal AC/DC Power Adapter
- Cigarette Lighter Adapter
- Remote Control with 3V Battery
- Audio Cable
- Video Cable
- User's Guide
- Quick Reference Guide

Limited Warranty

Who Provides the Limited Warranty

During the warranty period, the GoVideo Warranty Administrator will honor service for 90 days labor, 1 year parts from the original date of consumer purchase. See below for Commercial, Industrial or Educational use coverage. Remote controls are warranted for 90 days from the date of purchase.

90 days labor
1 year parts

Who is Protected

This warranty protects the original consumer owner of this GoVideo product.

What is Covered and How Long

This warranty covers internal operating parts and service/labor to repair or replace covered parts in this GoVideo product for 90 days labor, 1 year parts, from the date of purchase, defined as follows: (1) Original Consumer Retail Purchase; (2) First Rental Purchase Agreement; or (3) First Lease Purchase Agreement (the "Warranty Period"). Labor and replacement parts supplied during the Warranty Period are covered only for the remaining portion of the original Warranty Period. The GoVideo Warranty Administrator shall have no liability for service under this warranty if non-OEM (Original Equipment Manufacturer) replacement parts are used in the repair of your GoVideo product.

What the Owner Must Do If Service is Required

Please contact our customer service department at 1-800-736-7679 to repair or replace your product, at GoVideo's option, if it proves to be defective in material or workmanship under normal use, during the warranty period listed above, effective from the date of original consumer purchase of the product. Repaired or replacement units are warranted for the remaining period of the original warranty. Please retain dated sales receipt. Within the warranty period, the customer pays for inbound shipping charges and GoVideo pays return shipping charges.

Other Warranty Coverage

Commercial, Industrial or Educational use has the same warranty coverage as stated in this warranty.

What are the Exceptions

This warranty does not cover: (1) Normal maintenance service, such as cleaning. (2) Damage from misuse, abuse neglect or accident, natural disasters or Acts of God. (3) Cabinetry, decorative parts, A/C adapters, knobs or buttons. (4) The foreign country use of this product. (5) GoVideo product which has been electronically or mechanically modified in any way or incorporated into other products. (6) Installation and setup service adjustments. (7) Owner instruction. Your Owner's Guide provides information regarding operating instructions and user controls. For additional information, contact your authorized GoVideo dealer.

Go Video is not responsible for any shipping, handling or insurance charges.

This Exclusive Limited Warranty excludes all incidental and consequential damages. Some states do not allow the exclusion of incidental and consequential damages, so the above exclusion may not apply to you.

ALL IMPLIED WARRANTIES, INCLUDING IMPLIED WARRANTIES OF MERCHANTABILITY AND FITNESS FOR A PARTICULAR PURPOSE ARE LIMITED IN DURATION TO THE DURATION OF THIS WARRANTY PERIOD. Some states do not allow limitations on how long an implied warranty lasts, so the above limitation may not apply to you.

This Exclusive Limited Warranty gives you specific legal rights and you may also have other rights which vary from state to state.

GOVIDEO WARRANTY ADMINISTRATOR

7835 East McClain Drive • Scottsdale, Arizona 85260-1732
customersupport@govideo.com
1-800-736-7679

GO.VIDEO[®]

Free Manuals Download Website

<http://myh66.com>

<http://usermanuals.us>

<http://www.somanuals.com>

<http://www.4manuals.cc>

<http://www.manual-lib.com>

<http://www.404manual.com>

<http://www.luxmanual.com>

<http://aubethermostatmanual.com>

Golf course search by state

<http://golfingnear.com>

Email search by domain

<http://emailbydomain.com>

Auto manuals search

<http://auto.somanuals.com>

TV manuals search

<http://tv.somanuals.com>