

GO.VIDEO®

# DDV9300



## USER'S GUIDE

4-Head to 4-Head  
V C R / V C R  
with One Touch Copy

Manual #209300

## Congratulations!

...on your purchase of the Go-Video Dual-Deck VCR.

Record the model number and serial number from the back of your VCR here. Attach your sales receipt and/or a copy of your charge slip for reference.

Model Number: \_\_\_\_\_

Serial Number: \_\_\_\_\_

Purchase Date: \_\_\_\_\_

Note: *It is important that you register your Dual-Deck VCR with Go-Video, Inc. To register your Dual-Deck VCR, complete the warranty registration card and mail it in.*

### WARNING:

To reduce the risk of fire or electric shock, do not expose this appliance to rain or moisture. Do not open the cabinet; dangerous high voltage is present. Refer servicing to qualified personnel only. This video cassette recorder should only be used with 120V, 60Hz (standard U.S. household) current.

Federal law provides severe civil and criminal penalties for the unauthorized reproduction, distribution, or exhibition of copyrighted motion pictures and videotapes. (Title 17, United States Code, Sections 501 and 506).

### USER/INSTALLER CAUTION:

Your authority to operate this FCC certified equipment could be voided if you make changes or modifications not expressly approved by the manufacturer, who is responsible for compliance with Part 15 FCC rules.

### NOTE TO CATV SYSTEM INSTALLER:

This reminder is provided to call the CATV system installer's attention to Article 820-40 of the National Electronic Code that provides guidelines for proper grounding and, in particular, specifies that the cable ground shall be connected to the grounding system of the building, as close to the point of cable entry as practical.

### CAUTION:

To prevent fire, shock hazard, or annoying interference, use only the recommended accessories.

To prevent electric shock, do not use this (polarized) plug with an extension cord, receptacle, or other outlet unless the blades can be fully inserted to prevent blade exposure.

To reduce the risk of electric shock, do not remove the unit cover or back. There are no serviceable parts inside. Refer servicing to qualified personnel only.

### CUIDADO:

Para prevenir incendio, riesgo de choque, o interferencia enfadosa, use solamente los accesorios recomendados.

Para prevenir electrochoque, no use este enchufe (polarizado) con un cordón de extensión, toma de corriente, o cualquier otra toma a menos que los dientes puedan ser completamente insertados para prevenir exposición de los dientes.





Para reducir el riesgo de descarga eléctrica, no remueva la cubierta o la parte posterior del VCR. Dentro del VCR no hay partes que requieren servicio. Diríjase solamente a personal calificado cuando requiera servicio.

### ATTENTION:

Pour éviter les incendis, risque de chocs, ou interférences fâcheuses, employer seulement les accessoires recommandés.

Pour éviter les chocs électriques, ne pas employer cette prise (polarisée) avec une rallonge, une prise de courant ou une autre sortie de courant à moins que les lames peuvent être insérées à fond pour l'exposition des lames.

Pour réduire les risques de chocs électriques, ne pas retirer le couvercle ou l'arrière du module. Il n'y a pas de pièce utilisable à l'intérieur. Ne faire effectuer l'entretien que par un personnel qualifié.

  <p><b>CAUTION</b> RISK OF ELECTRIC SHOCK DO NOT OPEN</p>	 <p>This symbol is intended to alert the user to the presence of uninsulated dangerous voltage within the product's enclosure that may be of sufficient magnitude to constitute risk of fire or electric shock.</p>
<p>CAUTION: TO REDUCE THE RISK OF ELECTRIC SHOCK DO NOT REMOVE COVER NO USER-SERVICEABLE PARTS INSIDE REFER SERVICING TO QUALIFIED SERVICE PERSONNEL</p>	 <p>This symbol is intended to alert the user to the presence of important operating and maintenance instructions in the literature accompanying this product.</p>

# Safety Instructions

1. **READ INSTRUCTIONS** - All the safety and operating instructions should be read before the unit is operated.
2. **RETAIN INSTRUCTIONS** - The safety and operating instructions should be retained for future reference.
3. **HEED WARNINGS** - All warnings on the unit and in the operating instructions should be adhered to.
4. **FOLLOW INSTRUCTIONS** - All operating and maintenance instructions should be followed.
5. **CLEANING** - Unplug this video unit from the wall outlet before cleaning. Do not use liquid or aerosol cleaners. Use a dry cloth for dusting cabinet.
6. **ATTACHMENTS** - Do not use attachments not recommended by the video product manufacturer, as they may be hazardous.
7. **WATER & MOISTURE** - Do not use this video unit near water—for example, near a bathtub, wash bowl, kitchen sink, laundry tub, in a wet basement, near a swimming pool or the like.
8. **ACCESSORIES** - Do not place this video unit on an unstable cart, stand, tripod, bracket or table. The video unit may fall, causing serious injury to a child or adult, and serious damage to the unit. Use only with a cart, stand, tripod, bracket or table recommended by the manufacturer or sold with the video unit. Any mounting of the unit should follow the manufacturer's instructions and should use a mounting accessory recommended by the manufacturer.
- 8a. An appliance and cart combination should be moved with care. Quick stops, excessive force, and uneven surfaces may cause the appliance and cart combination to overturn.
9. **VENTILATION** - Slots and openings in the cabinet are provided for ventilation to ensure reliable operation of the video unit and to protect it from overheating. These openings must not be blocked or covered. Never place your VCR on a bed, sofa, rug or other similar surface, on or near a radiator or heat register. This video unit should not be placed in a built-in installation such as a bookcase or rack unless proper ventilation is provided or the manufacturer's instructions have been adhered to.
10. **POWER SOURCES** - This video unit should be operated only from the type of power source indicated on the marking label. If you are not sure of the type of power supply to your home consult your appliance dealer or local power company. For video units intended to be operated from battery power, or other sources, refer to the operating instructions.
11. **GROUNDING OR POLARIZATION** - This video unit may be equipped with either a polarized 2-wire AC line plug (a plug having one blade wider than the other) or a 3-wire grounding plug having a third (grounding) pin.  

The 2-wire polarized plug will fit into the power outlet only one way. This is a safety feature. If you are unable to insert the plug fully into the outlet try reversing the plug. If the plug still fails to fit, contact your electrician to replace your obsolete outlet. Do not defeat the safety purpose of the polarized plug.

## **PORTABLE CART WARNING**

(Symbol provided by RETAC)



12. **POWER-CORD PROTECTION** - Power-supply cords should be routed so that they are not likely to be walked on or pinched by items placed upon or against them, paying particular attention to cords of plugs, convenience receptacles, and the point where they exit from the unit.
13. **OUTDOOR ANTENNA GROUNDING** - If an outside antenna or cable system is connected to the video unit, be sure the antenna or cable system is grounded to provide some protection against voltage surges and built-up static charges. Section 810 of the National Electrical Code, ANSI/NFPA No. 70-1984, provides information with respect to proper grounding of the mast and supporting structure, grounding of the lead-in wire to an antenna discharge unit, size of grounding conductors, location of antenna-discharge unit, connection to grounding electrodes, and requirements for the grounding electrode. See figure below.

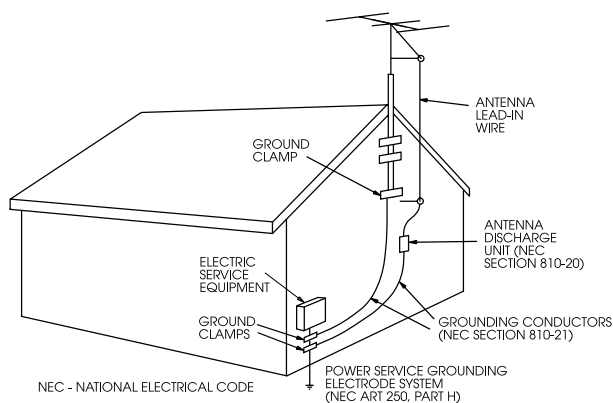

14. **LIGHTNING** - For added protection of this video unit during a lightning storm, or when it is left unattended and unused for long periods of time, unplug it from the wall outlet and disconnect the antenna or cable system. This will prevent damage to the video unit due to lightning and power line surges.
15. **POWER LINES** - An outside antenna system should not be located in the vicinity of overhead power lines or other electric light or power circuits, where it can fall into such power lines or circuits. When installing an outside antenna system extreme care should be taken to keep from touching such power lines or circuits as contact with them might be fatal.
16. **OVERLOADING** - Do not overload wall outlets and extension cords as this can result in the risk of fire or electric shock.
17. **OBJECTS AND LIQUIDS** - Never push objects of any kind into this video unit through openings as they may touch dangerous voltage points or short out parts that could result in a fire or electric shock. Never spill liquids of any kind onto the unit. Should spillage occur, unplug unit and have it checked by a technician before use.
18. **SERVICING** - Do not attempt to service this video unit yourself as opening or removing covers may expose you to a dangerous voltage or other hazards. Refer all servicing to qualified service personnel.
19. **DAMAGE REQUIRING SERVICE** - Unplug this video unit from the wall outlet and refer servicing to qualified service personnel under the following conditions:
- When the power supply cord or plug is damaged.
  - If any liquid has been spilled onto or objects have fallen into the video unit.
  - If the video unit has been exposed to rain or water.
  - If the video unit does not operate normally by following the operating instructions. Adjust only those controls that are covered by the operating instructions. Improper adjustment of other controls may result in damage and will often require extensive work by a qualified technician to restore the video unit to its normal operation.
  - If the video unit has been dropped or the cabinet has been damaged.
  - When the video unit exhibits a distinct change in performance—this indicates a need for service.
20. **REPLACEMENT PARTS** - When replacement parts are required, be sure the service technician has used replacement parts specified by the manufacturer or those having the same characteristics as the original part. Unauthorized substitutions may result in fire, electric shock or other hazards.
21. **SAFETY CHECK** - Upon completion of any service or repairs to this video unit ask the service technician to perform safety checks to determine that the video unit is in safe operating order.
22. **HEAT** - This video unit should be situated away from heat sources such as radiators, stoves, or other products (including amplifiers) that produce heat.

# Dual-Deck VCR

## Table of Contents

Introduction - Discover the Dual-Deck™ Difference .....	5
Chapter 1 - Connecting Your Dual-Deck VCR .....	7
Chapter 2 - The Dual-Deck System™ .....	9
<b>Remote Control Buttons</b> .....	9
<b>Front Panel Buttons and Indicators</b> .....	10
<b>Front Panel Display</b> .....	10
<b>Front and Rear Audio/Video Inputs</b> .....	11
<b>On-Screen Display</b> .....	12
<b>On-Screen Menu System</b> .....	13
<b>Summary of Automatic Features</b> .....	14
Chapter 3 - Initial Settings .....	15
<b>Setting the Language</b> .....	15
<b>Setting the Clock</b> .....	16
<b>Setting Antenna &amp; Channel Memory</b> .....	17
<b>Basic Tuner Settings</b> .....	17
Chapter 4 - Copy Features .....	23
<b>Copying a Tape</b> .....	23
<b>EZ-Copy</b> .....	23
<b>Copy Mode</b> .....	24
<b>Speed Matching</b> .....	24
<b>Audio Insert</b> .....	25
Chapter 5 - Playback Features .....	19
<b>Playing a Tape</b> .....	19
<b>Auto Play/Rewind</b> .....	19
<b>Special Playback Functions</b> .....	20
<b>Sequential &amp; Loop Play</b> .....	21
<b>Automatic Tracking</b> .....	21
<b>Remote Eject</b> .....	22
Chapter 6 - Record Features .....	27
Recording a TV Program .....	27
<b>One Touch Recording</b> .....	27
<b>Tape Length</b> .....	28
<b>Record Speed</b> .....	28
<b>Record Source</b> .....	28
<b>Sequential &amp; Loop Record</b> .....	29
<b>Date/Time Stamp</b> .....	29

Go▲Video is a registered trademark of Go-Video, Inc. Copy Tape, AmeriChrome, Video Sequencing and Dual-Deck VCR are trademarks of Go-Video, Inc. All other trademarks remain the property of their respective companies.

Setting Timer to Record Later .....	30
<b>Complete Program Record .....</b>	<b>31</b>
<b>Timer Record Errors .....</b>	<b>32</b>
<b>Timer Record Priorities .....</b>	<b>32</b>
Chapter 7 - Editing Features .....	33
Automatic Assembly Editing .....	33
<b>Preparing an Edit List .....</b>	<b>33</b>
<b>Performing an Assembly Edit .....</b>	<b>34</b>
Sync Editing .....	35
<b>Continuing a Sync Edit .....</b>	<b>36</b>
<b>Making Quality Edits .....</b>	<b>36</b>
Chapter 8 - Searching & Index Features .....	37
<b>Tape Counter .....</b>	<b>37</b>
<b>Memory Stop .....</b>	<b>37</b>
<b>VHS Index Search System .....</b>	<b>38</b>
<b>Index Scan .....</b>	<b>38</b>
<b>Index Search .....</b>	<b>38</b>
<b>Automatic Show Finder .....</b>	<b>38</b>
Chapter 9 - Advanced Connections .....	39
<b>Cable Converter Box Hookup .....</b>	<b>39</b>
<b>Alternative Cable Converter Box Hookup .....</b>	<b>40</b>
<b>Audio Connections .....</b>	<b>42</b>
<b>Monitor Connections .....</b>	<b>43</b>
<b>Connecting Other Video Equipment .....</b>	<b>44</b>
Chapter 10 - Helpful Information .....	45
<b>Frequently Asked Questions .....</b>	<b>45</b>
<b>Technical Specifications .....</b>	<b>49</b>
<b>Limited Warranty .....</b>	<b>50</b>
Appendix A - Multi-Brand Remote Setup .....	51
Dual-Deck Index .....	53



# Discover the Dual-Deck™ Difference

Welcome to the Go-Video family! It is our pleasure to congratulate you as a new owner of the Dual-Deck VCR, quite possibly the most versatile VCR ever made. No other VCR allows you to:

- Copy a tape at the touch of a button
- Watch a tape while recording a favorite program
- Record from two sources simultaneously
- Play or record two tapes consecutively or in a continuous loop.

The Dual-Deck VCR does all these things and *much more!*

## Make Picture Perfect Copies at the Touch of a Button

Gone are the days of tangled clumsy cables between two VCR decks. Gone is the loss of picture quality from intervening cables that degrade the signal. Gone is the flutter, roll and flashing from bad copies.

Go-Video provides you with a simple solution to quality copies of virtually any video source. Both decks communicate with one another by means of a behind-the-scenes marvel known as AmeriChrome™ circuitry. As the video signal is processed, the recording heads on both decks are synchronized resulting in picture-perfect copies every time.

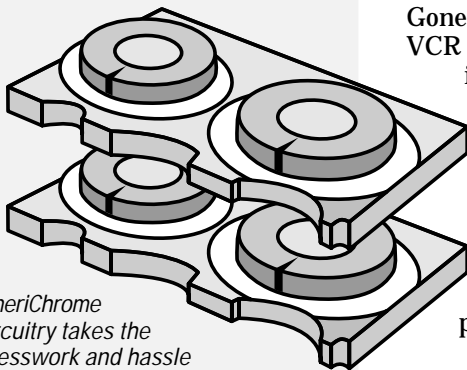

*AmeriChrome  
Circuitry takes the  
guesswork and hassle  
out of copying videos.*

## Two Decks, One Set of Controls

With one remote control for both decks, operating your Dual-Deck VCR couldn't be easier. Just press the Deck Select button to switch control back and forth between decks. What's more, you can program your multi-brand remote control to operate almost any television (see p.51).

## Dual-Deck Feature Summary

The following are just a few of the many features you will enjoy with your Dual-Deck VCR:

- Quality Copies of Any Video at the Touch of a Button
- Eight-Scene Automatic Editing
- Four Video Heads on Both Decks for High Quality Special Effects
- Multi-Brand Remote Control Operates Dual-Deck and Most TVs
- Patented AmeriChrome Circuitry
- Automatic Power Off when Rewinding, Timer Recording, One-Touch Recording, Copying Tapes, and using EZ-Copy
- Automatic Display Dimmer, Play, Power On, Power Off, Rewind, Stop, Memory and Remote Eject
- TV View Button for Easy Switching among Deck 1, Deck 2, Tuner and Accessories
- Date and Time Stamp for 5 Seconds at the Beginning of Any Recording
- Convenient Front A/V Jacks
- Complete Program Record to Ensure You Never Miss the End of a Timer Recording
- Automatic Show Finder to Locate Your Recordings Quickly and Easily
- Real Time Counter in Hours, Minutes and Seconds
- On-Screen Programming in Two Languages (English & French)



# Connecting Your Dual-Deck VCR

This chapter will walk you through the necessary steps to hook up your VCR. Your Dual-Deck VCR connects to your TV and antenna in exactly the same way as any other VCR. If you already own a VCR, take a few minutes to note how it is hooked up. Then simply swap the Dual-Deck with your old VCR using the same settings and connections.

## Choosing the Right Hookup

Choose the appropriate hookup from the following list:

- 1** If you are connecting your Dual-Deck VCR to a basic antenna or cable system, use the Basic Antenna/Cable Hookup on page 8.
- 2** If you have a cable system with a converter box (some or all channels are scrambled or premium), you have two choices:
  - a.** Cable Converter Box Hookup - *Pro:* You can watch and record any cable channel to which you subscribe. *Con:* You cannot watch a second channel while you are recording a cable channel. See page 39.
  - b.** Alternative Cable Converter Box Hookup - *Pro:* You can watch a second channel while you are recording a TV program. *Con:* You can only record non-scrambled channels. See page 40.
- 3** If you wish to listen to your TV and VCR through your stereo system, see Audio Connections on page 42.
- 4** If you have a TV with audio/video input jacks and desire better quality, you can connect your VCR to your TV with RCA cables. See Monitor Connections on page 43.
- 5** If you wish to connect your Dual-Deck VCR to another VCR, laser disc player, DVD player, video camera, camcorder, satellite receiver or video game, see Connecting Other Video Equipment on page 44.

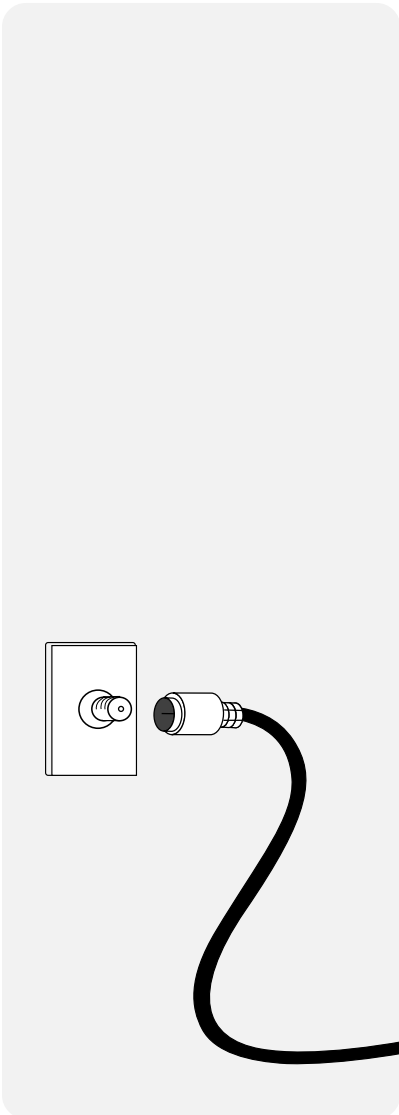

## Basic Antenna/Cable Hookup

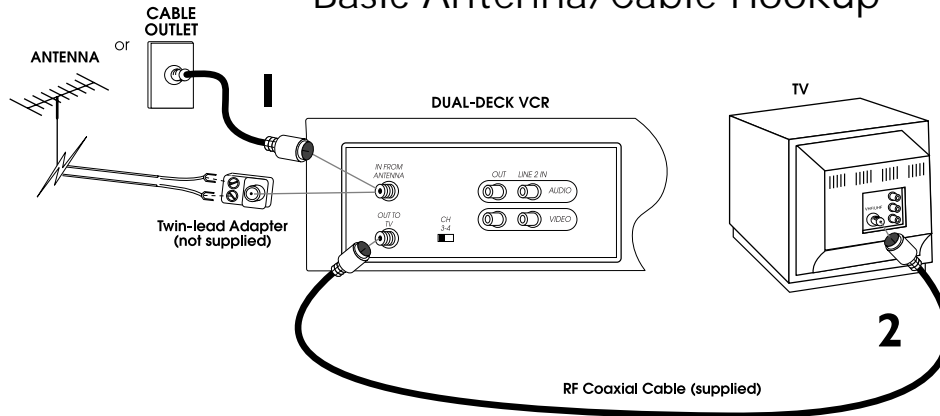

- 1 Connect the Antenna/Cable to the VCR** - Disconnect the antenna or cable from your TV and connect it to the IN FROM ANTENNA jack on the back of your VCR. If your antenna cable is twin-lead, you will need to purchase an adapter, available at your local electronics store.
- 2 Connect the VCR to Your TV** - Attach the supplied RF Coaxial Cable from the OUT TO TV connection on the back of the VCR to the VHF IN or CABLE IN connection on the back of your TV.
- 3 Set the channel** on the back of your VCR to 3 or 4 (whichever is not being used by a local TV broadcast).
- 4 Turn on the power** for your VCR and your TV.
- 5 Tune your TV** to channel 3 or 4 (whichever you set as the output channel in step 3).
- 6 Connection is complete!** Turn to Chapter 2 to familiarize yourself with the location of your Dual-Deck controls, or turn to Chapter 3 for Initial Settings.

If you have separate VHF and UHF antennas you will need to purchase a combiner, available at your local electronics store.

From Antenna

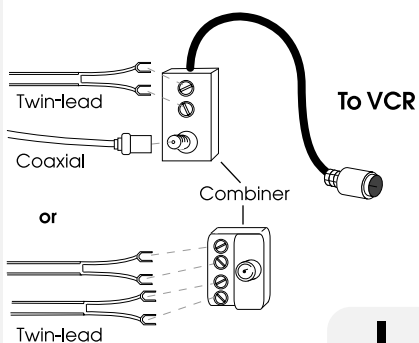

If your TV has separate video and audio input connections, you will achieve best results by using the Monitor Connections hookup on page 43.

# The Dual-Deck System™

## Remote Control Buttons

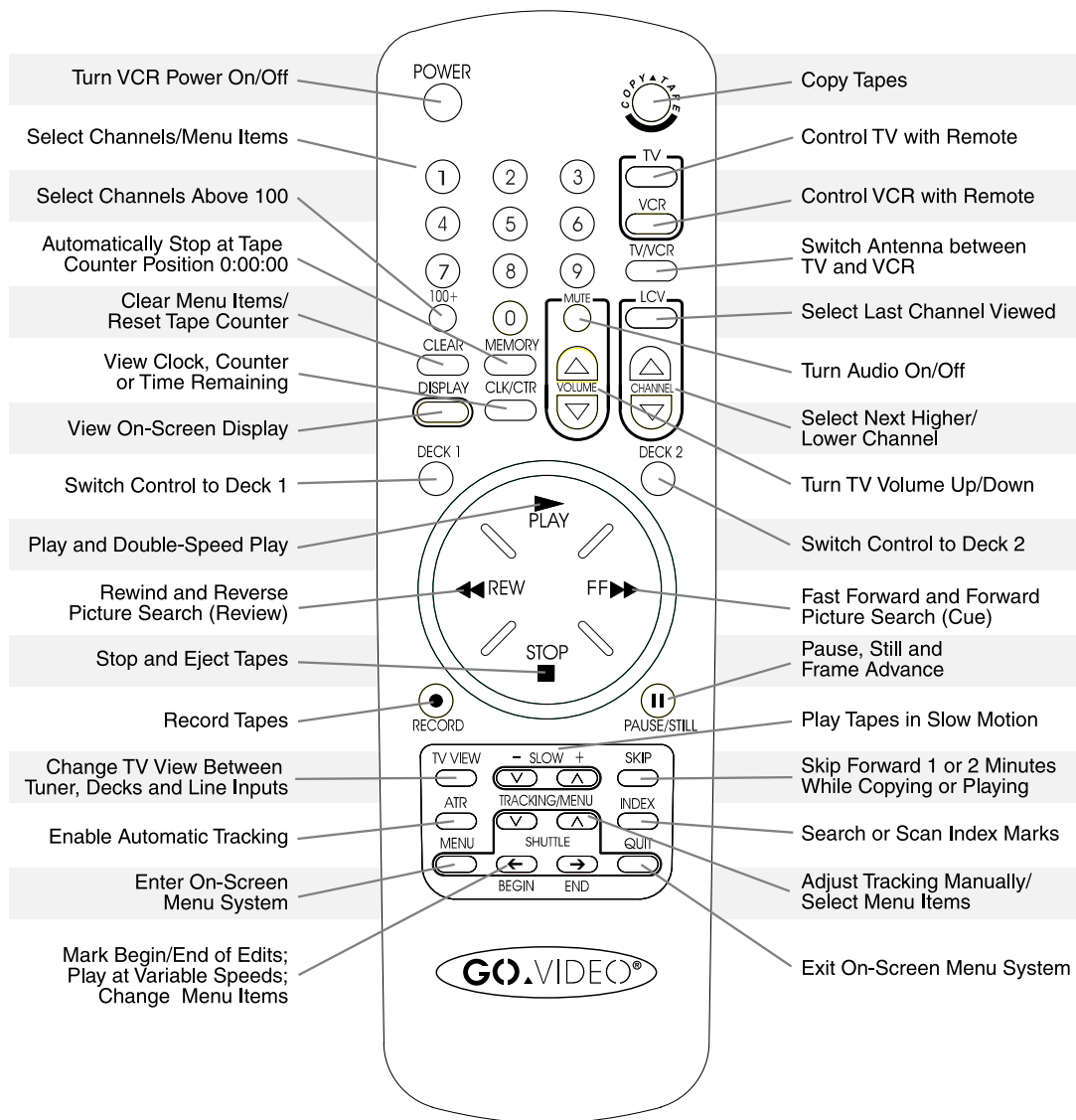

## Front Panel Buttons and Indicators

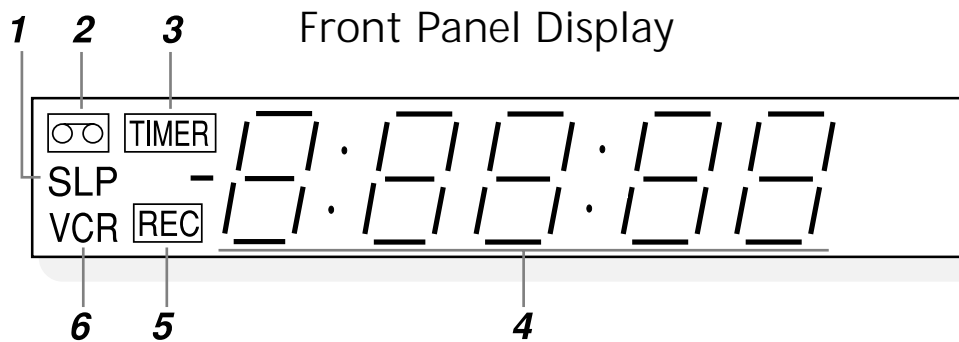
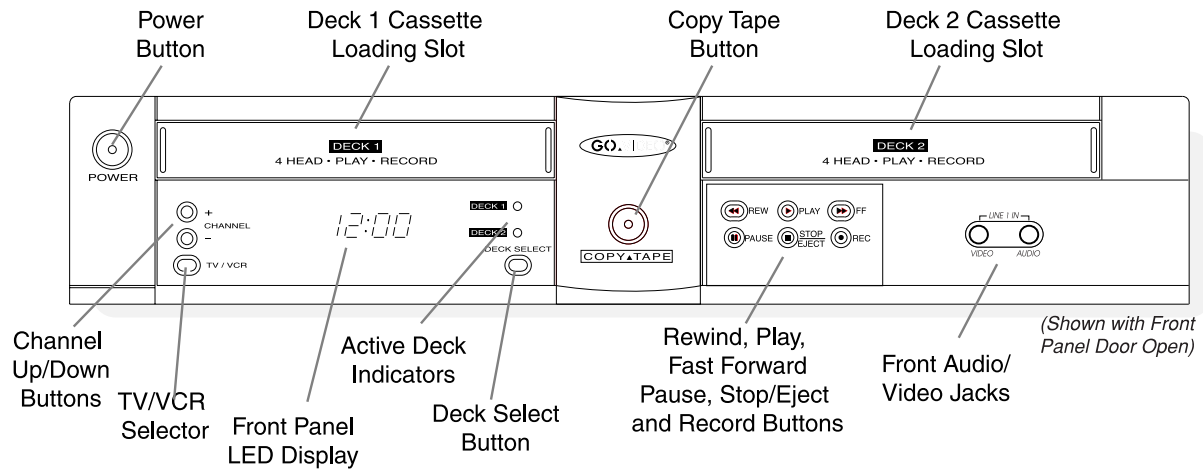

- 1 Tape Speed**  
 SP is Standard Play  
 LP is Long Play  
 SLP is Super Long Play
- 2 Tape Status**  
 On if Tape is inserted  
 in the selected deck
- 3 Timer Status**  
 On if Timer Recording is  
 programmed, Flashing if  
 Timer Record Error

- 4 Character Display**  
 Multi-Function Display with  
*Deck Status Indicators*  
 See table on p.11
- Channel Number*  
 Displays the selected channel
- Clock/Counter/Time Remaining*  
 Press CLK/CTR on remote control  
 to switch display between Clock,  
 Tape Counter and Time Remaining

- 5 Record Status**  
 On if Recording in  
 the selected deck
- 6 TV/VCR Indicator**  
 On if using VCR tuner,  
 Off if using TV tuner.

## Deck Status Indicators

<b>EJECT</b>	Tape is Ejecting	<b>PLAY2</b>	Deck is Playing Double Speed
<b>STOP</b>	Deck is Stopped	<b>CUE</b>	Deck is in Forward Picture Search (blinking=Jet Search)
<b>FFWD</b>	Deck is Fast Forwarding	<b>REVEW</b>	Deck is in Reverse Picture Search (blinking=Jet Search)
<b>REW</b>	Deck is Rewinding	<b>STILL</b>	Deck is in Play Still
<b>REC</b>	Deck is Recording	<b>SLOW</b>	Deck is in Slow Motion
<b>PAUSE</b>	Deck is in Record Pause		
<b>PLAY</b>	Deck is Playing		

### DISPLAY SETTINGS

1 :	SET CLOCK	
2 :	LANGUAGE / IDIOMA / LANGUE	
3 →	PANEL DISPLAY	AUTO
4 :	SCREEN DISPLAY	AUTO
5 :	FACTORY SETTINGS	
	SELECT : [ ↓ ↑ ]	CHANGE : [ ← → ]
	MENU : [ MENU ]	END : [ QUIT ]

Adjust the Front Panel Display to Dim at night by selecting Auto.

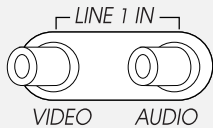

Front Audio/Video Inputs

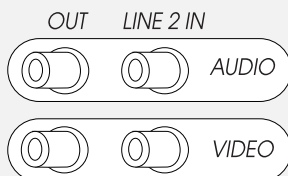

Rear Audio/Video Inputs

## Front Panel Display Settings

You can set the Front Panel Display to dim in the DISPLAY SETTINGS menu.

- 1** Press the **[MENU]** button until the DUAL-DECK FEATURES menu appears.
- 2** Press "1" to select VCR SETTINGS/SET CLOCK.
- 3** Press "1" to select DISPLAY SETTINGS/CLOCK.
- 4** Press "3" repeatedly to set PANEL DISPLAY to:

Auto - Turns the Front Panel Display on, but dims automatically between the hours of 10:00 P.M. and 6:00 A.M.

On - Turns Front Panel Display on (bright at all times).

Off - Turns Front Panel Display off.

## Front and Rear Audio/Video Inputs

Your Dual-Deck VCR has Front and Rear Audio/Video Inputs which allow you to play and record from a variety of accessories. Each input includes 2 jacks for use with RCA cables:

- 1** Video Jack (yellow)
- 2** Audio Jack (white)

The front inputs are ideal for quick hookup of a camcorder or video game, while the rear jacks are well suited for a more permanent connection, such as a satellite receiver, laser disc player or DVD player (see page 44). To ensure successful use of these inputs, pay special note to how they are labeled:

- Front Audio/Video Inputs = Line 1
- Rear Audio/Video Inputs = Line 2

**P**ress **[TVVIEW]** on your Remote Control for fast, easy switching between Line inputs, as well as among Deck 1, Deck 2 and the TV Tuner.



## On-Screen Display

The On-Screen Display (OSD) appears on your screen automatically when you turn on the power, press a deck function key (such as Play, Rewind, etc.), or change channels. It will disappear automatically after a few seconds.

To bring up the OSD manually, press the **DISPLAY** key on the remote control. If you do this, it will remain on the screen until you press **DISPLAY** again.

Below is an overview of the On-Screen Display:

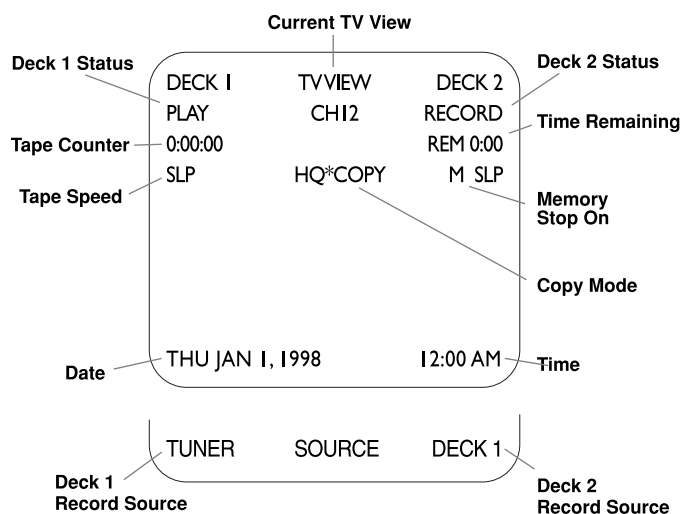

The On-Screen Display also shows you:

- Copy Mode (see p.20)
- Timer Record Errors and Status (see p.31)
- Edit List Information (see p.33)

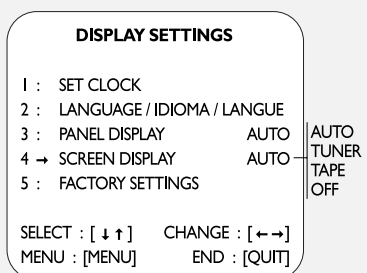

For a fully functioning OSD, set Screen Display to Auto.

## Screen Display Settings

You can adjust the status of the On-Screen Display in the DISPLAY SETTINGS menu.

- 1 Press the **MENU** button until the DUAL-DECK FEATURES menu appears.
- 2 Press "1" to select VCR SETTINGS/SET CLOCK.
- 3 Press "1" to select DISPLAY SETTINGS/CLOCK.
- 4 Press "4" repeatedly to set SCREEN DISPLAY to:
  - Auto - Fully functioning automatic On-Screen Display.
  - Tuner - Displays information about the Tuner, but not about the two decks (convenient for "channel surfers").
  - Tape - Displays information about the two decks but not about the Tuner (convenient for editing tapes).
  - Off - On-Screen Display is off (you will still be able to bring up the On-Screen Display manually by pressing **DISPLAY** on your Remote Control).

**1**

**DUAL-DECK FEATURES**

1 → VCR SETTINGS / SET CLOCK  
 2 : COPY TAPE SETTINGS  
 3 : 8-SCENE EDIT LIST  
 4 : PLAYBACK MODE     NORM  
 5 : RECORD MODE        NORM

SELECT : [ ↓ ↑ ]     CHANGE : [ ← → ]  
 MENU : [MENU]

**2**

**DECK ONE SETTINGS**

1 → TAPE LENGTH        T120  
 2 : TIMER RECORD  
 3 : RECORD SPEED        SP  
 4 : RECORD SOURCE        AUTO

SELECT : [ ↓ ↑ ]     CHANGE : [ ← → ]  
 MENU : [MENU]

**3**

**DECK TWO SETTINGS**

1 → TAPE LENGTH        T120  
 2 : TIMER RECORD  
 3 : RECORD SPEED        SP  
 4 : RECORD SOURCE        AUTO

SELECT : [ ↓ ↑ ]     CHANGE : [ ← → ]  
 MENU : [MENU]     END : [QUIT]

Press **[MENU]** repeatedly to cycle through the Dual-Deck VCR's three main menus.

---

**DISPLAY SETTINGS**

1 : SET CLOCK  
 2 : LANGUAGE / IDIOMA / LANGUE  
 3 : PANEL DISPLAY        AUTO  
 4 : SCREEN DISPLAY        AUTO  
 5 → FACTORY SETTINGS

SELECT : [ ↓ ↑ ]     CHANGE : [ ← → ]  
 MENU : [MENU]

**CAUTION : MENU SETTINGS WILL BE CLEARED**

1 → KEEP CLOCK / TIMER EVENT  
 2 : CLEAR EVERYTHING

PRESS [CLEAR] TO CONFIRM

SELECT : [ ↓ ↑ ]     CHANGE : [ ← → ]  
 MENU : [MENU]     END : [QUIT]

Select Factory Settings to restore all menu items to their defaults.

## On-Screen Menu System

The On-Screen Menu System allows you to program all the features of your Dual-Deck VCR. To navigate the On-Screen Menu System, use the following keys:

Press	In order to:
<b>[MENU]</b>	Enter the On-Screen Menu system and cycle through the three main menus: Dual-Deck Features, Deck One Settings and Deck Two Settings.
<b>[V] [^]</b>	Move up or down to highlight the menu item you wish to select.
<b>[←] [→]</b>	Cycle through the choices for each menu item.
<b>[1] [2] [3] [4] [5] [6] [7] [8] [9] [0]</b>	Highlight the desired menu item and cycle through each option. (This method is used in the instructions throughout this manual.)
<b>[QUIT]</b>	Save your choices and exit the menu system.

## Factory Settings

To clear any changes you have made to the menu settings and restore the original Go-Video factory settings (refer to the inside back cover to view these default settings):

- 1 Press the **[MENU]** button until the DUAL-DECK FEATURES menu appears.
- 2 Press "1" to select VCR SETTINGS/SET CLOCK.
- 3 Press "1" to select DISPLAY SETTINGS/CLOCK.
- 4 Press "5" to select FACTORY SETTINGS (a red menu will appear.)
- 5 Press "1" to keep your clock and timer events, or "2" to clear all settings.
- 6 Press **[CLEAR]** to confirm your choice and restore the factory settings.

*Note:* If you decide you do not want to clear your settings, press **[QUIT]** to exit the menu system or **[MENU]** to return to the DISPLAY SETTINGS menu.

## Summary of Automatic Features

For your convenience, the Dual-Deck VCR comes with a variety of automatic features:

### Auto Power On

Power turns on automatically when a tape is inserted into either deck or when a Timer Recording starts.

### Auto Power Off

If you press **[POWER]** while Rewinding, Copying, Timer Recording, One-Touch Recording or using EZ-Copy, the VCR will power off automatically when that function is completed. The **[POWER]** button will blink to indicate that Auto Power Off is activated. To deactivate Auto Power Off, press **[POWER]** again.

### Auto Play

When a tape without a record safety tab is inserted into either deck, your Dual-Deck VCR will play the tape automatically. To set Auto Play see page 23.

### Auto Rewind

Your Dual-Deck VCR will automatically rewind when the end of the tape is reached while playing, fast forwarding or recording. To set Auto Rewind see page 23.

- Notes:*
- During Loop Record, the tape will always rewind automatically.
  - During Timer Record, the tape will never Auto Rewind (to prevent accidental erasure by another Timer Event).

### Auto Stop

The VCR will stop automatically if a deck is left in Play Still or Record Pause for more than 5 minutes. This prevents excessive wear on the videotape.

### Auto Dimmer

The Dual-Deck VCR front panel display will dim between the hours of 10:00 PM and 6:00 AM. To set Auto Dimmer see page 11.

### Memory Stop

Memory Stop causes your Dual-Deck VCR to stop automatically at counter position 0:00:00 when rewinding or fast forwarding. To set Memory Stop see page 37.

### Remote Eject

Remote Eject allows you to eject tapes with your remote control by pressing **[STOP]** twice. To set Remote Eject see page 26.



# Initial Settings

## Initial Settings

Before you start using your Dual-Deck VCR, you must adjust three initial settings:

- Language (English or French)
- Clock
- Antenna and Channel Memory

### Setting the Language

The first time you press **MENU** after hooking up your VCR or after a power failure, you will automatically see the LANGUAGE/LANGUE menu. At that time choose your language preference (skip directly to Step 5). To change the language at any other time, follow each of these steps.

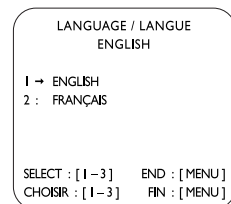

Set the Menu Language to English or French.

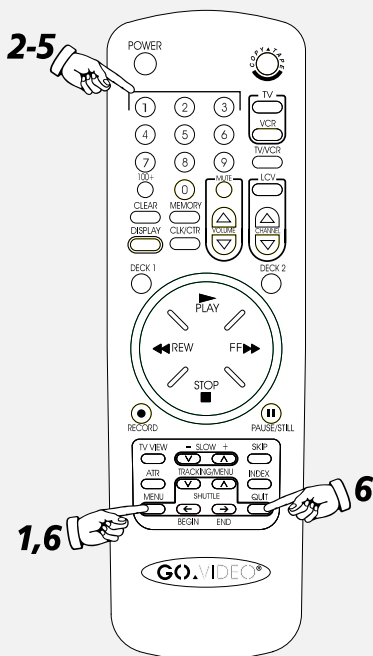

- 1 Press the **MENU** button until the DUAL-DECK FEATURES menu appears.
- 2 Press "1" to select VCR SETTINGS/SET CLOCK.
- 3 Press "1" to select DISPLAY SETTINGS/CLOCK.
- 4 Press "2" to select LANGUAGE/LANGUE.
- 5 Press the number button corresponding to your desired language ("1" for English, "2" for French).
- 6 Press the **MENU** button to save your selection and return to the DISPLAY SETTINGS menu.

*Note:* The first time you set the language, pressing **MENU** will automatically bring up the Set Clock menu (see next page).

**I**f you select French accidentally, you can reset the display to English automatically by unplugging the VCR for at least 60 seconds.



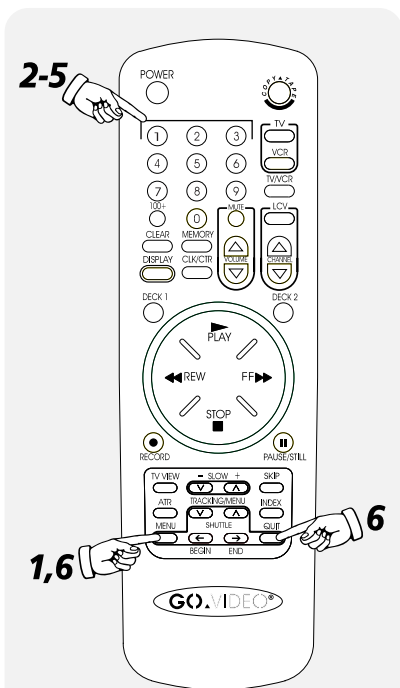

## Setting the Clock

After you set the language for the first time, the Set Clock menu will appear automatically (skip to Step 5). To set the clock at any other time follow each of these steps:

- 1 Press **[MENU]** until the DUAL-DECK FEATURES menu appears.
- 2 Press "1" to select VCR SETTINGS/SET CLOCK.
- 3 Press "1" to select DISPLAY SETTINGS/CLOCK.
- 4 Press "1" to select SET CLOCK.
- 5 Press the number buttons to enter information as you are prompted by the blinking cursor. If you don't need to change the information for a particular item, press **[→]** to move to the next item.

Set Month (1-12) January is "01", October is "10", etc.

Set Year (0-99) Enter only the last two digits. For example "98" for "1998".

Set Day (1-31) Enter today's date. For example, if today is the fourth, enter "04".

Set Hour (1-12) Enter only the hour. For example, if the time is 4:28, the hour is "04".

Set Minute (0-60) Enter only the minute. For example, if the time is 4:28, the minute is "28".

Set AM/PM (1-2) Enter "1" for AM or "2" for PM.

Set Daylight Savings Time (1-2) Enter "1" for AUTO or "2" for OFF. AUTO will automatically add one hour on the first Sunday in April ("Spring forward") and subtract one hour on the last Sunday in October ("Fall back").

- 6 Press **[QUIT]** to save and exit the menu system, or press **[MENU]** to save and return to the DISPLAY SETTINGS menu.

**DUAL-DECK FEATURES**

1 → VCR SETTINGS / SET CLOCK  
 2 : COPY TAPE SETTINGS  
 3 : 8-SCENE EDIT LIST  
 4 : PLAYBACK MODE      NORM  
 5 : RECORD MODE        NORM

SELECT : [↑↓]    CHANGE : [←→]  
 MENU : [MENU]

**VCR SETTINGS**

1 → DISPLAY SETTINGS / CLOCK  
 2 : TUNER / CHANNEL LIST  
 3 : REMOTE EJECT        ON  
 4 : AUTO PLAY / REWIND   BOTH  
 5 : DATE / TIME STAMP    TIMER

SELECT : [↑↓]    CH  
 MENU : [MENU]

**DISPLAY SETTINGS**

1 → SET CLOCK  
 2 : LANGUAGE / IDIOMA / LANGUE  
 3 : PANEL DISPLAY        AUTO  
 4 : SCREEN DISPLAY  
 5 : FACTORY SETTING

SELECT : [↑↓]    CH  
 MENU : [MENU]

**SET MONTH [1 - 12] : 01**

JAN 1998      12:00AM

SU MO TU WE TH FR SA

                                 I 2 3

4 5 6 7 8 9 10

11 12 13 14 15 16 17

18 19 20 21 22 23 24

25 26 27 28 29 30 31

DLST: AUTO

MENU : [MENU]    END : [QUIT]

*If you need to go back and change an item, press **[←]** or **[→]** until you see the item, then enter the new information.*

*If you change the Date & Time accidentally, press **[CLEAR]** to restore the original clock settings, then press **[QUIT]** to exit.*

*It is important to set the Dual-Deck VCR's internal clock to ensure accuracy on Timer Recordings and Date/Time Stamps.*

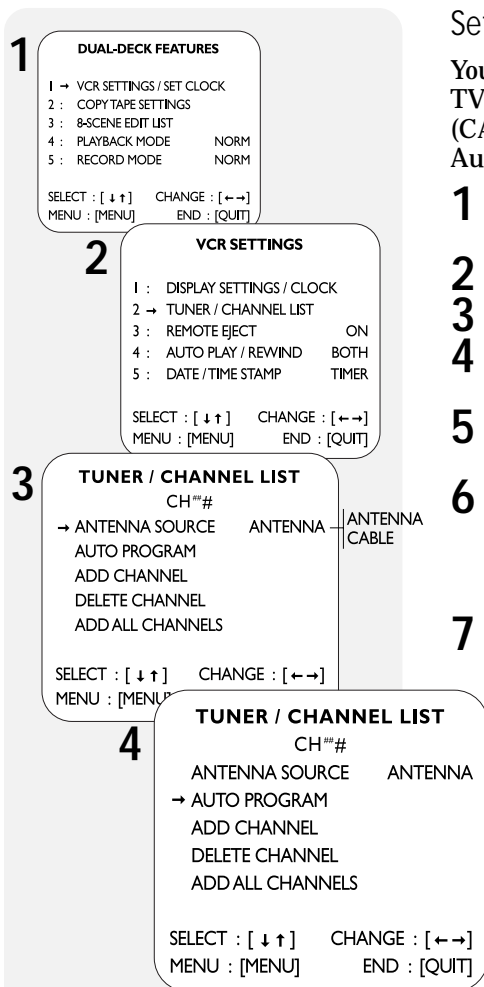

## Setting Antenna & Channel Memory

Your Dual-Deck VCR will automatically tune in all available TV Stations whether from Antenna reception or Cable (CATV). Simply indicate the Antenna Source and then run Auto Program:

- 1 Press **[MENU]** until the DUAL-DECK FEATURES menu appears.
- 2 Press "1" to select VCR SETTINGS/SET CLOCK.
- 3 Press "2" to select TUNER/CHANNEL LIST.
- 4 Press **[right]** repeatedly to set the ANTENNA SOURCE to Antenna or Cable.
- 5 Press **[up]** or **[down]** to move the selection arrow to AUTO PROGRAM.
- 6 Press **[right]** to begin Auto Program. The VCR will cycle through all possible TV or cable channels and automatically place the channels you receive into Channel Memory. This will take a few minutes to complete.
- 7 Press **[QUIT]** to exit the menu system or **[MENU]** to return to the VCR SETTINGS menu.

 If you are using a cable converter box, you will need to set your VCR's tuner channel to receive only the cable converter box output channel (see p.39).

**Y**our channel list must have a minimum of 2 channels; one channel is not valid.



You can change channels with the Channel Up/Down buttons or directly with the number keys.

## Basic Tuner Settings

### Channel Selection

- Tuning with the Channel Up/Down Buttons

Press the **[CHANNEL]** Up/Down buttons on the remote control or on the Dual-Deck VCR's front panel to move up or down to the desired channel.

- Tuning with the Number Buttons

For channels 1 through 9, press "0" then press the corresponding number button (1-9). If you are tuning to a channel higher than 100, press **[100+]** and then enter the last two digits.

- Selecting Line 1 or Line 2

You can select Line 1 or Line 2 with the **[CHANNEL]** Up/Down buttons. Line inputs are located after the highest programmed station and before the lowest programmed station. When you select Line 1 or Line 2, you will see the input (if any) from additional video equipment connected to your Front or Rear Audio/Video inputs.

**TUNER / CHANNEL LIST**

CH##  
ANTENNA SOURCE ANTENNA  
AUTO PROGRAM  
→ ADD CHANNEL  
DELETE CHANNEL  
ADD ALL CHANNELS

SELECT : [↓↑] CHANGE : [←→]  
MENU : [MENU] END : [QUIT]

*You can manually Add and  
Delete Channels in the Tuner/  
Channel List menu.*

## Adding or Deleting Channels

The first time you set up your Dual-Deck VCR, you must use AUTO PROGRAM before you can manually add or delete channels. To add or delete channels manually:

- 1** From the TUNER/CHANNEL LIST menu, press the number keys to tune in the desired channel.
- 2** Press  $\downarrow$  or  $\uparrow$  to move the selection arrow to Add Channel or Delete Channel.
- 3** Press  $\rightarrow$  to add or delete the selected channel.
- 4** If you wish to add every channel, move the selection arrow to Add All Channels and press the  $\rightarrow$  key.

# Copy Features



**COPY▲TAPE**

The Copy Tape button  
is your key to one-  
touch copies.

## COPYTAPE SETTINGS

1 :	COPY MODE	AUTO	
2 :	SPEED MATCHING	ON	
3 →	EZ-COPY	OFF	OFF
4 :	AUDIO INSERT	OFF	ON

SELECT : [↓↑]    CHANGE : [←→]  
MENU : [MENU]    END : [QUIT]

Turn EZ-Copy on or off in the  
Copy Tape Settings menu

## Copying a Tape

Copying tapes is what owning a Dual-Deck VCR is all about. Just follow these simple steps:

- 1 Insert your source tape into Deck 1 on the left side of the Dual-Deck VCR.
- 2 Insert your target tape into Deck 2 on the right side of your VCR.
- 3 Press **COPYTAPE** on the front panel of your Dual-Deck VCR or on your remote control. Your Dual-Deck VCR will begin copying from Deck 1 to Deck 2.

*Note:* When you press Copy Tape, Deck 1 rewinds a few seconds (called “pre-roll”) and Deck 2 goes into Record Pause mode automatically before copying begins. This “synchro-start” results in the best possible quality when copying and editing.

- 4 To pause the copying process, press **COPYTAPE**. To resume, press **COPYTAPE** again. To stop the copying process, press **STOP** on Deck 2.

## EZ-Copy

EZ-Copy automates every step of the Copy Tape process: At the touch of a button, your Dual-Deck VCR automatically rewinds both tapes, copies the entire tape from Deck 1 to Deck 2, rewinds both decks again and ejects the tapes. To activate EZ-Copy.

- 1 Press **MENU** until the DUAL-DECK FEATURES menu appears.
- 2 Press “2” to select COPY TAPE SETTINGS.
- 3 Press “3” repeatedly to set EZ-COPY to:

On - EZ-Copy is enabled. To activate, simply insert your tapes and

press the **COPYTAPE** button.

Off - EZ-Copy is disabled.

**I**f EZ-Copy ends without rewinding and ejecting the tape then a problem occurred during the copy. Most likely the tape in Deck 2 was not long enough to record the entire source tape.



**COPY TAPE SETTINGS**

1 →	COPY MODE	AUTO	AUTO
2 :	SPEED MATCHING	ON	HQ1
3 :	EZ-COPY	OFF	HQ2
4 :	AUDIO INSERT	OFF	

SELECT : [↓↑]    CHANGE : [←→]  
MENU : [MENU]    END : [QUIT]

Set the Copy Mode to Auto, HQ1 or HQ2

**COPY TAPE SETTINGS**

1 :	COPY MODE	AUTO	ON
2 →	SPEED MATCHING	ON	OFF
3 :	EZ-COPY	OFF	OFF
4 :	AUDIO INSERT	OFF	

SELECT : [↓↑]    CHANGE : [←→]  
MENU : [MENU]    END : [QUIT]

Speed Matching ensures that both decks are synchronized for optimal copy quality

## Copy Mode

Your Dual-Deck VCR offers three copy modes: Auto, HQ1 and HQ2. HQ (High Quality) refers to Go-Video's patented AmeriChrome Circuitry for optimal duplicating results. To set the Copy Mode:

- 1** Press **[MENU]** until the DUAL-DECK FEATURES menu appears.
- 2** Press "2" to select COPY TAPE SETTINGS.
- 3** Press "1" repeatedly to set COPY MODE to:

Auto - Automatically selects the best copy mode based on the speed of the source tape.

HQ1 - Best if the source tape is in SP or for any tape with Copy Guard.

HQ2 - Best if source tape is in LP or SLP without Copy Guard.

## Speed Matching

During a Copy Tape session, Speed Matching automatically sets the Deck 2 record speed to be the same as the Deck 1 playback speed. You will get the best copy quality when this feature is turned on.

- 1** Press **[MENU]** until the DUAL-DECK FEATURES menu appears.
- 2** Press "2" to select COPY TAPE SETTINGS.
- 3** Press "2" repeatedly to set SPEED MATCHING to:

On - Use when optimal copy quality is desired. The recording speed will automatically match the play speed in Deck 1.

Off - Use only if you want to record two or more SP tapes onto one SLP tape. If so, you must set the Record Speed manually in the DECK TWO SETTINGS menu (see page 28).

 If you wish to view a TV program while copying a tape, push **[TV VIEW]** until you see the Tuner, then change channels with the remote.

### COPY TAPE SETTINGS

1 :	COPY MODE	AUTO	
2 :	SPEED MATCHING	ON	
3 :	EZ-COPY	OFF	OFF
4 →	AUDIO INSERT	OFF	LINE1 LINE2

SELECT : [ ↓ ↑ ]    CHANGE : [ ← → ]  
MENU : [MENU]    END : [QUIT]

*Audio Insert gives you the option of adding a new audio track to your copies*

## Audio Insert

You can add taped music or voice-overs to your copies with Audio Insert. When Audio Insert is on, the audio signal comes from the Audio In jacks on the front or rear panel.

- 1 Press **[MENU]** until the DUAL-DECK FEATURES menu appears.
- 2 Press **"2"** to select COPY TAPE SETTINGS.
- 3 Press **"4"** repeatedly to set AUDIO INSERT to:

Off - Audio Insert is disabled.

Line 1 - Audio signal comes from the Audio In jacks on the front panel. This new audio signal replaces the tape's original audio track.

Line 2 - Audio signal comes from the Audio In jacks on the rear panel. This new audio signal replaces the tape's original audio track.

*Note:* When you are finished using Audio Insert, be sure to go back and turn this feature off; otherwise your subsequent copies may not have audio (i.e., if there is no signal from Line 1 or Line 2).

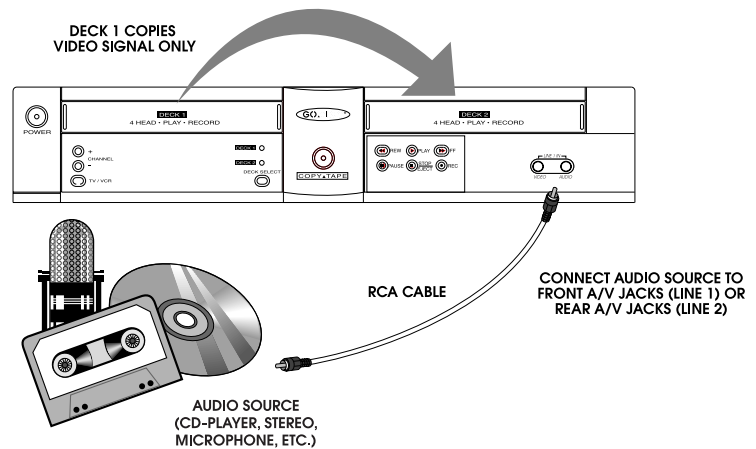

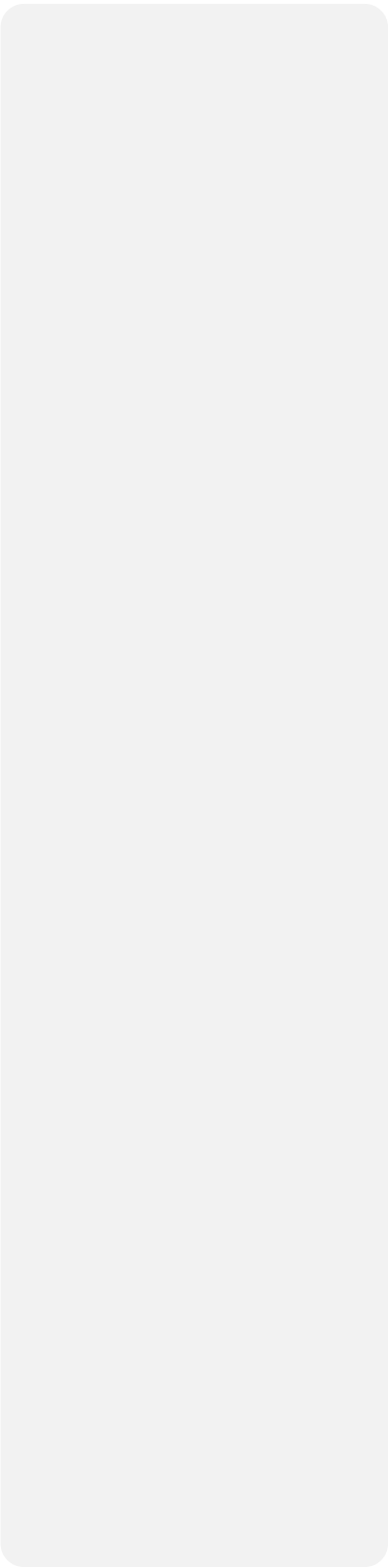



# Playback Features

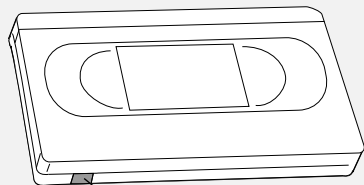

Record Safety Tab

VCR SETTINGS	
1 :	DISPLAY SETTINGS / CLOCK
2 :	TUNER / CHANNEL LIST
3 :	REMOTE EJECT ON
4 →	AUTO PLAY / REWIND BOTH
5 :	DATE / TIME STAMP TIMER
SELECT : [↓↑]    CHANGE : [←→] MENU : [MENU]    END : [QUIT]	

Set your Auto Play/Rewind options in the VCR SETTINGS menu

## Playing a Tape

It's easy to play back tapes with your Dual-Deck VCR:

- 1 Insert a videotape into either deck of your VCR.
- 2 If the tape is missing the record safety tab and AUTO PLAY is on, the tape will begin to play automatically.
- 3 If AUTO PLAY is set to off (see Auto Play/Rewind below), press **[PLAY]** to begin playing the tape.
- 4 Press **[STOP]** to stop the playback. Press **[STOP]** a second time to remote eject the tape (see page 26).



## Auto Play/Rewind

You can set your Dual-Deck VCR to play and/or rewind your tapes automatically. Just follow these steps:

- 1 Press **[MENU]** until the DUAL-DECK FEATURES menu appears.
- 2 Press "1" to select VCR SETTINGS/SET CLOCK.
- 3 Press "4" repeatedly to set AUTO PLAY/REWIND to:

**BOTH** - Tapes without the record safety tab will play automatically when inserted. All tapes will rewind automatically when finished playing, fast forwarding or recording.

**PLAY** - Tapes will only play automatically.

**REW** - Tapes will only rewind automatically.

**OFF** - Tapes will neither play nor rewind automatically.

**F**or best results when editing, set Auto Play/Rewind to Rew or Off. This will prevent tapes without record safety tabs from playing unexpectedly.



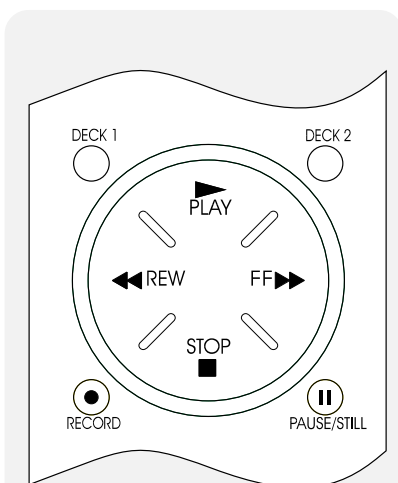

Get behind the wheel for some exciting playback functions.



## Special Playback Functions

The following Special Playback Functions can be activated whenever a tape is playing. To resume normal playback, press **PLAY** again or press **STOP** to stop the tape.

**Play Still** - Pause the tape for a stop action picture.

Press **PAUSE** to enter Play Still mode. The picture will freeze on the screen. "Still" will appear on the Front Panel Display.

**Frame Advance** - Search a tape frame-by-frame.

While in Play Still mode, press **PAUSE** again to advance the picture one frame. If the deck remains in Play Still mode for 5 minutes, it will resume playing to prevent possible damage.

**Double-Speed** - Play tapes at twice normal speed.

While playing a tape, press **PLAY** again to enter Double-Speed Playback. "Play2" will appear on the Front Panel Display.

**Slow Motion** - Play tapes in Slow Motion.

Press **SLOW** (down arrow) or **SLOW** (up arrow) to enter Slow Motion Playback. "Slow" will appear on the Front Panel Display. Each time you press **SLOW** (down arrow), the playback slows down a little and each time you press **SLOW** (up arrow), the slow motion playback speeds up a little.

**Picture Search** - Search a tape at high speed

Press and release **FF** to enter Forward Picture Search. "Cue" will appear on the Front Panel Display.

Press and release **REW** to enter Reverse Picture Search. "Review" will appear on the Front Panel Display.

**Jet Search** - Search a tape at *extra*-high speed:

Press and hold **FF** to enter Forward Jet Search. "Cue" will blink on the Front Panel Display. Release the **FF** key to resume playback.

Press and hold **REW** to enter Reverse Jet Search. "Review" will blink on the Front Panel Display. Release the **REW** key to resume playback.

**Skip** - Skip forward 1 or 2 minutes.

Press **SKIP** once to forward picture search for 60 seconds. Press **SKIP** twice to forward picture search for 120 seconds. This allows you to skip commercials while playing back tapes.

**Shuttle** - Search a tape at variable speeds.

Press **↔** to gradually speed up the tape. Press **↵** to gradually slow down and reverse the tape. See diagram at left.

**DUAL-DECK FEATURES**

1 : VCR SETTINGS / SET CLOCK  
 2 : COPY TAPE SETTINGS  
 3 : 8-SCENE EDIT LIST  
 4 → PLAYBACK MODE      NORM    NORM  
 5 : RECORD MODE        NORM    LOOP

SELECT : [ ↓ ↑ ]      CHANGE : [ ← → ]  
 MENU : [MENU]      END : [QUIT]

Set two tapes to play sequentially or in a continuous loop.

## Sequential & Loop Play

Two decks give you twice the playback features of a normal VCR. Sequential Play allows you to insert tapes in both decks and play one after another. Loop Play allows you to play both tapes in a continuous loop.

To activate Sequential or Loop Play:

- 1 Insert tapes in both decks.
- 2 Press **[MENU]** until the DUAL-DECK FEATURES menu appears.
- 3 Press "4" repeatedly to set PLAYBACK MODE to:

Norm - Tapes play normally.

Seq - (Sequential) Deck 1 plays to the end of the tape, then Deck 2 plays to the end of the tape. If Auto Rewind is set to on, both tapes will rewind automatically when playback is finished.

Loop - Deck 1 plays to the end of the tape, then Deck 2 begins playing. While Deck 2 is playing, Deck 1 automatically rewinds to the beginning. When playback is finished in Deck 2, Deck 1 plays again and the process repeats in a continuous loop until you press the **[STOP]** key. Rewinding is automatic regardless of the Auto Rewind setting.

## Automatic Tracking

Your Dual-Deck VCR is equipped with an Automatic Digital Tracking System which is activated whenever you insert a tape to play. While tracking is adjusted, you'll see ATR (Automatic Tracking) flash on the On-Screen Display.

If you need to adjust tracking manually:

- 1 Press the TRACKING **[▲]** & **[▼]** keys to move the white streaks up or down and out of the picture. This disables the ATR System.
- 2 To reactivate ATR, press the **[ATR]** key on the remote control.

### What is Tracking?

*Tracking adjusts the VCR's heads to fine tune playback. Your Dual-Deck VCR has both automatic and manual tracking.*



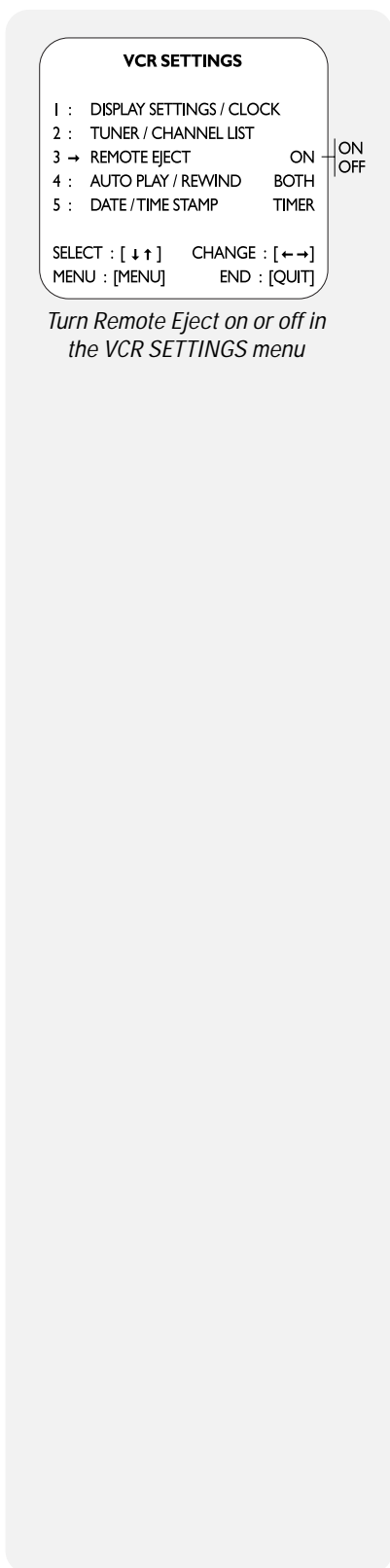

Turn Remote Eject on or off in the VCR SETTINGS menu

## Remote Eject

With Remote Eject on, you can eject tapes with the remote control by pressing the **STOP** button. To set this feature:

**1** Press **MENU** until the DUAL-DECK FEATURES menu appears.

**2** Press "1" to select VCR SETTINGS/SET CLOCK.

**3** Press "3" repeatedly to set REMOTE EJECT to:

**ON** - Allows you to eject tapes by pressing **STOP** on the remote control.

**OFF** - Disables Remote Eject to prevent you from inadvertently ejecting a tape.

*Note:* You can always eject tapes with the **STOP/EJECT** key on the Dual-Deck VCR front panel.

# Record Features



## Recording a TV Program

Your Dual-Deck VCR offers a variety of recording options, including One-Touch, Sequential, Loop and Timer Recording. To record a TV program:

- 1 Insert a blank tape into either deck.
- 2 Select the channel you want to record by pressing the **CHANNEL** Up/Down buttons on the remote control (or cable converter box if you have one).
- 3 Press **RECORD** to begin recording.

While you are recording the TV show, you can:

- Pause the recording by pressing **PAUSE** or stop the recording by pressing **STOP** (to resume recording, press **RECORD**).
- Watch a different channel by pressing **TV/VCR**, then use your TV's tuner to select the new channel.
- Watch a video by inserting a tape in the opposite deck and switching the **TVVIEW** button to that deck.
- Add recording time in half-hour increments with One Touch Recording (see below).

## One Touch Recording

Use **One-Touch Recording (OTR)** to record in 30 minute increments up to 9 hours and 30 minutes.

- 1 Press **RECORD** to start recording.
- 2 Press **RECORD** again to enter OTR mode (OTR 0:30 will appear on the On-Screen Display).
- 3 Keep pressing **RECORD** to add 30-minute increments to the total recording time up to 9:30.
- 4 When the record time has elapsed, the deck will stop automatically. If the **POWER** key is pushed during OTR, the VCR will turn off upon completion of recording.

**I**f you push **RECORD** one time beyond OTR 9:30, the VCR goes into LOOP mode, which allows the VCR to record in a continuous loop (see p.29).



DECK 1	TVVIEW	DECK 2
STOP	CH07	OTR 0:30
0:00:00		0:00:00
SLP		SP
THU JAN 1, 1998		12:00 AM

*On-Screen Display for One-Touch Recordings*

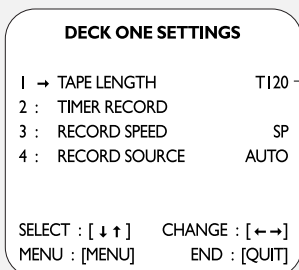

Select from among four standard Tape Lengths.

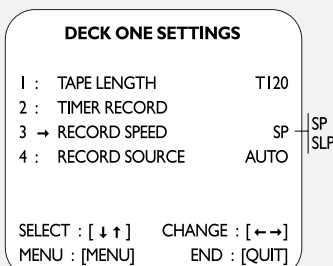

Set the Record Speed to SP or SLP.

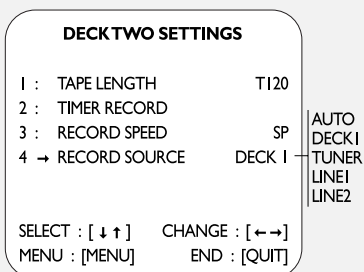

For best results and maximum editing features, the Deck 2 Record Source should be set to "Deck 1".

## Tape Length

Set the Tape Length to ensure accurate tape counter readings and Timer Recordings:

- 1 Press **[MENU]** until the DECK ONE SETTINGS or DECK TWO SETTINGS menu appears.
- 2 Press "1" repeatedly to set TAPE LENGTH to:
  - T-120 - 2 hours (SP); 6 hours (SLP)
  - T-160 - 2 hours 40 minutes (SP); 8 hours (SLP)
  - T-180 - 3 hours (SP); 9 hours (SLP)
  - T-200 - 3 hours 20 minutes (SP); 10 hours (SLP)

## Record Speed

You can record tapes at two speeds: SP (Standard Play) or SLP (Super Long Play). SLP is three times longer than SP.

- 1 Press **[MENU]** until the DECK ONE SETTINGS or DECK TWO SETTINGS menu appears.
- 2 Press "3" repeatedly to set RECORD SPEED to:

SP (Standard Play) - Use for best recording quality.

SLP (Super Long Play) - Use for maximum recording time.

Maximum Record/Playback Time		
VHS	SP	SLP (EP)
T-120	2 hrs	6 hrs
T-160	2 hrs 40 min	8 hrs
T-180	3 hrs	9 hrs
T-200	3 hrs 20 min	10 hrs

## Record Source

You can use your Dual-Deck VCR to record from a variety of sources, including the Tuner, Decks and Line inputs (see page 44 for tips on connecting additional video equipment).

- 1 Press **[MENU]** until the DECK ONE SETTINGS or DECK TWO SETTINGS menu appears.

- 2 Press "4" repeatedly to set RECORD SOURCE to:

Auto - Records whatever is currently visible on-screen (as selected using the **[TVVIEW]** button).

Deck 1 or 2- Records from the tape in the designated deck.

Tuner - Records the tuner channel selected on your VCR.

Line 1- Records from source connected to Front A/V Inputs.

Line 2 - Records from source connected to Rear A/V Inputs.

#### DUAL-DECK FEATURES

1 :	VCR SETTINGS / SET CLOCK		
2 :	COPY TAPE SETTINGS		
3 :	8-SCENE EDIT LIST		
4 :	PLAYBACK MODE	NORM	NORM
5 →	RECORD MODE	NORM	SEQ LOOP

SELECT : [ ↓ ↑ ]    CHANGE : [ ← → ]  
MENU : [MENU]      END : [QUIT]

*Set two tapes to record sequentially or in a continuous loop.*

#### VCR SETTINGS

1 :	DISPLAY SETTINGS / CLOCK		
2 :	TUNER / CHANNEL LIST		
3 :	REMOTE EJECT	ON	
4 :	AUTO PLAY / REWIND	BOTH	TIMER ALL CONT OFF
5 →	DATE / TIME STAMP	TIMER	

SELECT : [ ↓ ↑ ]    CHANGE : [ ← → ]  
MENU : [MENU]      END : [QUIT]

*Date/Time Stamp allows you to superimpose the Date, Time and Channel on all your recordings.*

## Sequential & Loop Record

Two decks give you twice the recording features of a normal VCR. Sequential Record allows you to insert tapes in both decks and record one after another. Loop Record allows you to record both tapes in a continuous loop.

To activate Sequential or Loop Record:

- 1 Insert tapes in both decks.
- 2 Press **[MENU]** until the DUAL-DECK FEATURES menu appears.
- 3 Press "5" repeatedly to set RECORD MODE to:

Norm - Tapes record normally.

Seq - (Sequential) Deck 1 records over the entire tape, then Deck 2 records over the entire tape. If Auto Rewind is set to on, both tapes will rewind automatically when recording is finished.

Loop - Deck 1 records to the end of the tape, then Deck 2 begins recording. While Deck 2 is recording, Deck 1 automatically rewinds to the beginning. When recording is finished in Deck 2, Deck 1 records again and the process repeats in a continuous loop until you press the **[STOP]** key. Rewinding is automatic regardless of the Auto Rewind setting.

## Date/Time Stamp

To help keep track of your tape collection, you can superimpose a Date/Time Stamp on both regular and Timer recordings. To activate the Date/Time Stamp:

- 1 Press **[MENU]** until the DUAL-DECK FEATURES menu appears.
- 2 Press "1" to select VCR SETTINGS/SET CLOCK.
- 3 Press "5" repeatedly to set DATE/TIME STAMP to:

Timer - The date, time, channel and duration will appear for 5 seconds at the start of Timer Recordings only.

All - The date, time and channel information will be recorded for about 5 seconds at the start of all recordings.

Cont - (Continuous) The date, time and channel information will record continuously on all recordings. This option disables the On-Screen Display and Menu system. Stop the recording to resume use of these functions.

Off - Date/Time Stamp is disabled.

**Note:** The Date/Time Stamp does not record during a Copy Tape session.

**U**se the Date/Time Stamp with the Automatic Show Finder feature to find specific programs on a tape with multiple recordings (see page 38).



## Setting Timer to Record Later

If you plan to be away and don't want to miss your favorite show, simply set a Timer Recording. Your Dual-Deck VCR can record up to eight events up to one year in advance.

*Note:* You must have the VCR's clock set to the correct date and time for Timer Recording to work (see page 16).

- 1** Press the **[MENU]** button until the DECK ONE SETTINGS or DECK TWO SETTINGS menu appears.
- 2** Press "2" to select TIMER RECORD.
- 3** Enter the number (1-8) of the event you wish to program.
- 4** Press the number buttons or **[V]** or **[^]** keys to enter information as you are prompted by the blinking cursor. If you don't need to change the information for a particular item, use **[←]** and **[→]** to move to the next item.

Month (1-12) January is "01", October is "10", etc.

Day (1-31) Enter the day of recording. For example, if the day is the fourth, enter "04".

Hour (1-12) Enter only the hour. For example, if the time is 4:28, the hour is "04".

Minute (0-59) Enter only the minute. For example, if the time is 4:28, the minute is "28".

AM/PM (1-2) Enter "1" for AM or "2" for PM.

Length of Event (0-9 Hours, 0-59 Minutes) Use the numerical buttons to enter the hours and minutes you want to record (HH:MM).

Type of Event (1-4)

"1" = 1-TIME (records once)

"2" = DAILY (records Monday through Friday)

"3" = WEEKLY (records once a week)

"4" = ALWAYS (records every day)

Record Source (1-4)

"1" = Tuner, then set the Channel (1-125)

"2" = Line 1, device connected to Front A/V Inputs

"3" = Line 2, device connected to Rear A/V Inputs

Record Deck (1-2)

"1" to choose Deck 1

"2" to choose Deck 2

Record Speed (1-3)

"1" to choose AUTO (See *Complete Program Record*, p.31)

"2" to choose SP

"3" to choose SLP

- 5** Press **[MENU]** to save these settings and view a summary of events you have programmed to record.

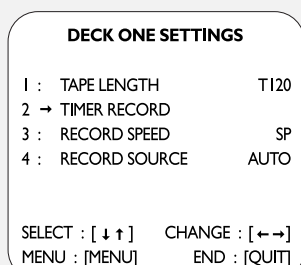

**1,2**

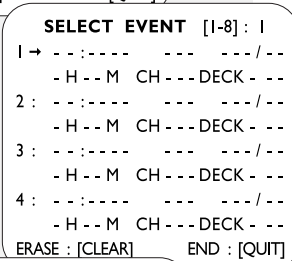

**3**

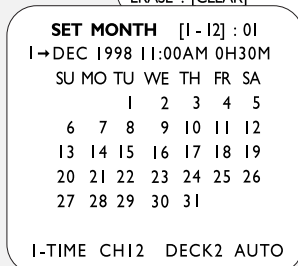

**4**



```

SELECT EVENT [1-8] : 1
1 → 08:00PM ON SAT OCT/10
    2H00M CH 12 DECK 1 SP
2 :
3 :
4 :
ERASE : [CLEAR]      END : [QUIT]

```

*Sample Summary of  
Timer Recording Event*

**6** To delete an event, use the  $\uparrow$  &  $\downarrow$  keys to highlight the event to be deleted on the summary screen and press **[CLEAR]** on the remote control.

**7** Press **[QUIT]** to exit the menu system. The red Timer indicator on the Front Panel Display will be on.

- Notes:*
- A Timer Recording will start at the programmed time whether the VCR's power is on or off.
  - To exit the Timer Record screen without making any changes, press **[CLEAR]**.
  - To stop a Timer Recording in progress, select the recording deck and press **[STOP]**.
  - If Timer flashes on the Front Panel Display, there is an error in the Timer Recording. Push **[DISPLAY]** on the remote control to view the cause of the error on the On-Screen Display (see Timer Record Errors below).

## Timer Record Errors

If there is a problem with your Timer Recording, you will see one of the following error messages on your On-Screen Display:

- **TAPE MISSING TAB** - The record safety tab is missing on your videotape. To record, you must cover the tab with cellophane tape.
- **TAPE MISSING** - There is no videotape in the recording deck. To record, you must insert a tape.
- **DECK NOT READY** - The recording deck is not ready to record because it is in use. To record, either stop the deck or wait for it to clear before proceeding.

## Timer Record Priorities

If you accidentally set the Timer to record different events (on different channels) at the same time, your Dual-Deck VCR prioritizes these events according to the following rules:

- 1** Priority is given to the event with the latest starting time. An event in progress will be interrupted by an event with a later starting time.
- 2** Priority is given to the event with the highest event number. If Event 1 and Event 2 start at the same time, the Dual-Deck VCR will record Event 2.

## Complete Program Record

Complete Program Record, or CPR, slows down the recording speed to help prevent you from missing the end of a Timer Recording. Here's how it works:

- CPR is activated automatically when you set the Record Speed to AUTO in a Timer Recording (see page 30).
- Tape Length must be set correctly for this feature to work (see page 28).

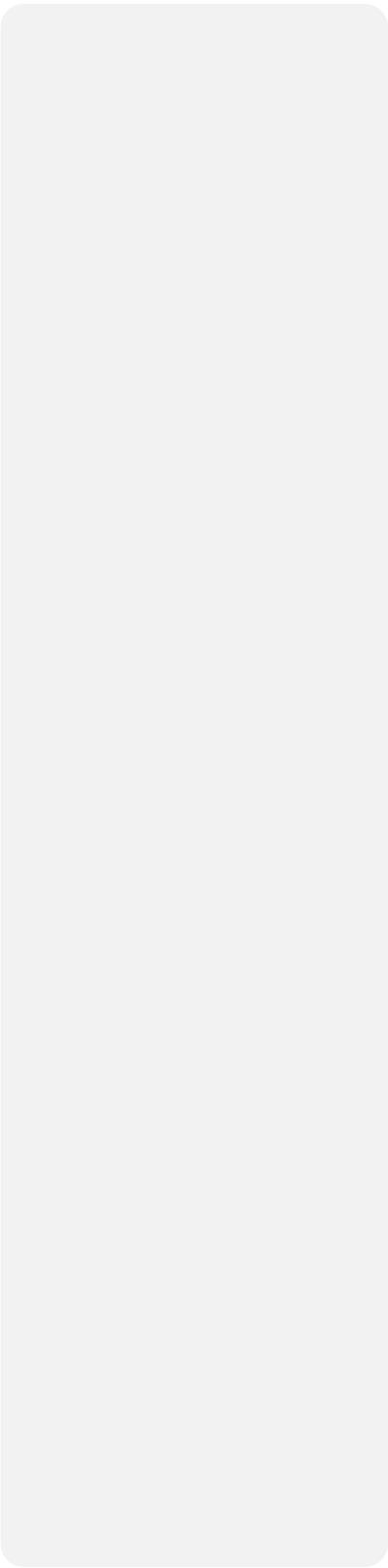
- 
- CPR automatically selects the recording speed which will give you the best quality for the time remaining on your tape. Since SP (Standard Play) is the highest quality, CPR selects this speed initially.
  - If CPR determines there is not enough time on the tape to record the entire Timer Recording, it will automatically change the speed to SLP. *Note:* Recording in SLP results in slightly lower quality than SP.

# Editing Features



## Videotape Editing

Two decks make editing your videos quick and easy. Choose from the following two editing methods:

- Automatic Assembly Editing - Use this method if you plan on making multiple or non-sequential edits. You mark the beginning and ending points of each scene (up to 8 at a time), and your Dual-Deck VCR assembles the scenes automatically (see below).
- Sync Editing - Use this method if you plan on making only a few edits in sequence. You edit each scene manually with a little help from the **COPYTAPE** button (see page 35).

## Automatic Assembly Editing

### Preparing an Edit List

The key to making clean, quality edits is planning. Carefully review your source tape before you edit:

- 1 Insert your source tape into Deck 1.
- 2 Rewind the tape to the beginning.
- 3 Press the **CLK/CTR** key on your remote control until you see the tape counter on the Front Panel Display.
- 4 Press **CLEAR** to reset the tape counter to zero.

*Note:* The tape counter automatically resets to 0:00:00 when you insert a tape. Remember to rewind the source tape and reset the counter to zero every time you insert it to ensure consistent tape counter readings.

- 5 Carefully review your source tape, using the Play, Still and Picture Search features. Think about which scenes to include in your final copy, and which to leave out.
- 6 As you are doing this, write down the tape counter positions for the beginning and ending of each scene on the source tape, and a brief description of what is happening in the scene.

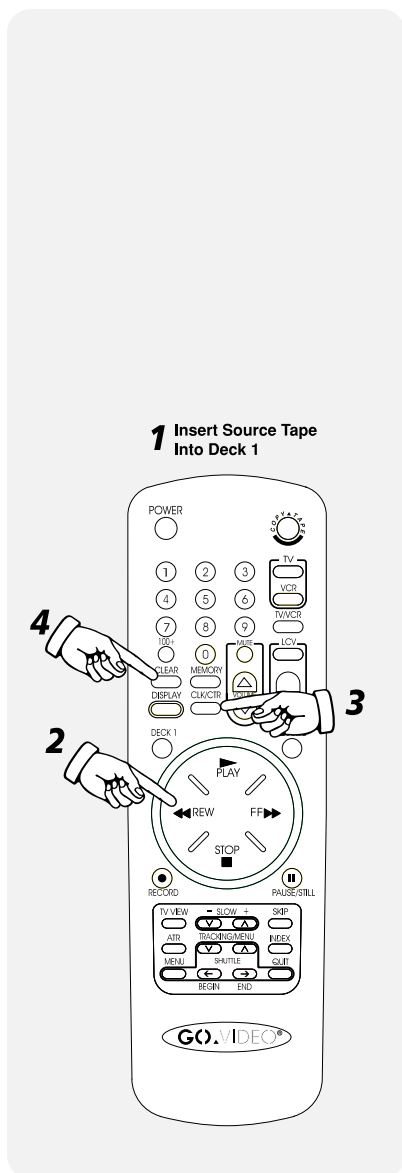

When you are finished, you will have an Edit List from the source tape. Here is an example of an Edit List from a child's birthday party:

Begin/End	Description
0:01:08 to 0:03:34	Josh opening birthday present - toy car.
0:03:34 to 0:04:00	Jiggled the camera - delete this part.
0:04:00 to 0:06:23	Josh opening present - tool kit.
0:06:23 to 0:10:30	Josh and Mary playing with toys.
0:10:30 to 0:11:06	Josh crying - delete this part.
0:11:06 to 0:15:46	Kids eating birthday cake.

**A**fter you are experienced with the procedures of automatic assembly editing, you may choose to skip the note taking step and directly enter the scenes during playback.

#### DUAL-DECK FEATURES

1 : VCR SETTINGS / SET CLOCK  
 2 : COPY TAPE SETTINGS  
 3 → 8-SCENE EDIT LIST  
 4 : PLAYBACK MODE        NORM  
 5 : RECORD MODE         NORM

SELECT : [ ↓ ↑ ]    CHANGE : [ ← → ]  
 MENU : [ MENU ]    END : [ QUIT ]

*You must insert a tape in Deck 1 in order to select 8-SCENE EDIT LIST.*

### Performing an Assembly Edit

Once your Edit List is complete, you're ready to assemble your tape. Let's say you've decided to copy your scenes in the following order, leaving out the scenes where the camera jiggled and Josh was crying.

- a. Josh opening toy car.
- b. Josh opening tool kit.
- c. Kids eating birthday cake.
- d. Josh & Mary playing with toys.

- 1 Press [MENU] until the DUAL-DECK FEATURES menu appears.
- 2 Press "3" to select 8-SCENE EDIT LIST. The following menu will appear (The "1" will be flashing):

```

SCENE : 1 2 3 4 5 6 7 8
        BEGIN :  :  :  :  :  :  :  :  :
        END   :  :  :  :  :  :  :  :

SCENE:[  ]    BEG/END:[ ←→ ]
MAKE A TAPE :    [ COPY TAPE ]
MENU:[ MENU ]    END:[ QUIT ]
  
```

- 3 Press "1" to program scene 1.

*Note:* You can program scenes out of sequence by selecting any number key from 1 to 8.



**COPY▲TAPE**

The Copy Tape Button makes  
Sync Editing a snap

- 4** Play the source tape in Deck 1 to the beginning of the first scene (in our example this is tape counter position 0:01:08). Press the **[BEGIN]** key to mark the beginning of the scene.
- 5** Play the tape to the end of the scene (in our example this is tape counter position 0:03:34). Press the **[END]** key to mark the end of the scene.

*Note:* After you program each scene, the next scene number will blink indicating it's ready to be programmed.

- 6** Press the number for the next scene you want to program (in our example, scene 2).
- 7** Repeat steps 4-6 until all scenes are programmed.
- 8** Press **[STOP]** to stop the tape in Deck 1.

*Note:* You cannot eject the tape in Deck 1 with the remote control if there are scenes in the Edit List.

- 9** Load a blank tape into Deck 2.
- 10** Press the **[COPY TAPE]** key. The Dual-Deck VCR will automatically copy each scene from Deck 1 to Deck 2 in the order programmed.
- 11** When editing is complete, stop Deck 2.

## Sync Editing

You can also perform assembly editing manually, also known as Sync (Synchronized) Editing.

*Note:* For best results when Sync editing, be sure to:

- Turn on the On-Screen Display (p.12)
- Turn off EZ-Copy (p.19)
- Turn off Auto Play (p.23)

- 1** Insert the source tape into Deck 1.
- 2** Insert the target tape into Deck 2.
- 3** Press **[DECK 2]** to select Deck 2.
- 4** Play the target tape in Deck 2 to approximately 3 seconds after the end of the last frame of the last scene, then press **[PAUSE/STILL]**.
- 5** Press **[RECORD]** for Deck 2. This puts the deck into Record Pause mode.
- 6** Press **[DECK 1]** to select Deck 1.
- 7** Play the source tape in Deck 1 to the beginning of the desired scene and press **[PAUSE/STILL]**. The Copy Tape button will blink.
- 8** Push **[COPY TAPE]** to begin editing.
- 9** The source tape will copy onto the target tape until you press **[STOP]** on Deck 2, or **[COPY TAPE]** again to make additional Sync Edits.

## Continuing a Sync Edit

During a Sync Edit, you can reposition the source tape and make additional edits. To do so, follow these steps:

**1** While the Sync Edit is in progress, press **[COPY TAPE]** again to enter Copy Tape Pause mode. Deck 1 will go into Play/Still and Deck 2 will go into Record/Pause. The Copy Tape button will blink.

*Note:* It is recommended that you copy 3-4 seconds beyond your next edit point to account for pre-roll (a slight rewinding of the tape prior to recording that ensures continuous tape coverage).

**2** Press **[DECK 1]** to select Deck 1.

**3** Play the source tape in Deck 1 to the beginning of the next scene and press **[PAUSE/STILL]**. The Copy Tape button will blink.

**4** Press **[COPY TAPE]** again to restart editing.

**5** Repeat steps 1-4 to continue Sync Editing, or press **[STOP]** on both decks to finish.

### Automatically Remove Commercials



Press **[SKIP]** while a Copy is in progress and your Dual-Deck VCR will automatically execute a 1 minute Sync Edit. Press **[SKIP]** twice to execute a 2 minute Sync Edit. This is ideal for removing commercials while making a copy.

## Making Quality Edits

It is not uncommon for “glitches” to occur during a manual assembly edit, usually at the end of a scene that is being recorded over old material.

This happens because the VCR's full erase head (which erases the video, audio and control tracks) is always a few seconds behind the recording heads. You may see a vibrating rainbow of color in the middle of the picture and sound can become unstable for a few seconds.

To improve the quality of your edits:

- Record with preformatted tape - You can format a tape by recording the Line input with no signal over the entire tape. First, unplug any device connected to your Front A/V Inputs. Next, set the Record Source to Line 1 in the DECK ONE SETTINGS or DECK TWO SETTINGS menu. Finally, record over the entire tape.
- Overlap your edits - Always copy the source tape 3-4 seconds beyond the end of each scene. This helps account for pre-roll when you edit the next scene.

# Searching & Index Features

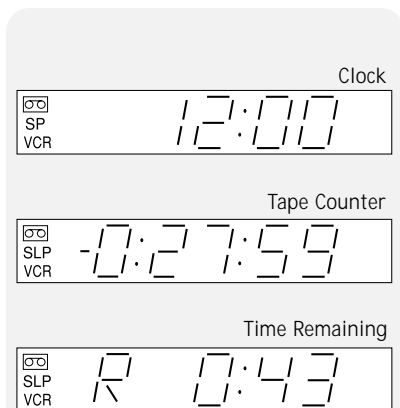
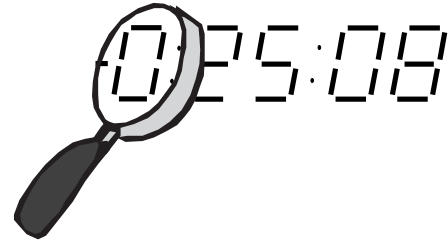

Press **CLK/CTR** to cycle the front panel display among the clock, tape counter and time remaining.

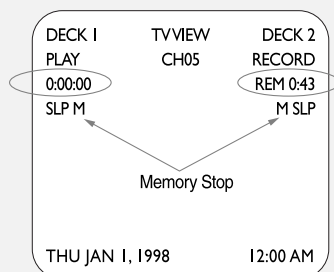

The Tape Counter (circled left) and Time Remaining (circled right) appear on-screen for both decks. The letter "M" signifies that Memory Stop is enabled.

## Tape Counter/Time Remaining

The Tape Counter shows you the exact location of your tapes in hours, minutes and seconds. The Time Remaining indicator shows you how much time is left until the end of the tape.

You can view the tape counter/time remaining in two places:

**Front Panel Display** - Press **CLK/CTR** repeatedly to switch the front panel display among the clock, tape counter and time remaining.

**On-Screen Display** - Press **DISPLAY** to view the counter or time remaining on-screen for both decks (the OSD will match the Front Panel Display).

To reset the tape counter:

- 1 Press **CLK/CTR** until the tape counter is displayed on the front panel display.
- 2 Press **CLEAR** to reset the counter to 0:00:00. You can do this anywhere on a tape.

*Note:* Any time you insert a tape into your Dual-Deck VCR, the Tape Counter will reset to zero automatically.

## Memory Stop

Memory Stop will automatically stop the tape at counter position 0:00:00 when rewinding or fast-forwarding. This is a handy feature when editing videotapes.

To activate Memory Stop:

- 1 Press **MEMORY** on the remote control. You will see an "M" below the tape counter setting on the On-Screen Display.
- 2 Press **REW** or **FF**. Your Dual-Deck VCR will advance to tape counter position 0:00:00 and stop automatically.

## VHS Index Search System

Your Dual-Deck VCR is equipped with a VHS Index Search System (VISS) to help you locate your recordings with ease. VISS is the industry standard, so you can use it with other VCRs and camcorders. Here's how it works:

- The VCR automatically places an Index Mark at the start of every recording (when this happens, you will see "IDX" flash briefly on the On-Screen Display).
- You can place Index marks manually at any time during a recording by pressing **[INDEX]** on the remote control. For best results, avoid placing Index Marks at the beginning of a tape or in segments less than 5 minutes in length.
- You can then Scan or Search for Index marks when the tape is stopped or playing by pressing **[INDEX]** (see below).

DECK ONE INDEX MENU  
INDEX : --

SCAN : [FFWD] / [REW]  
SEARCH : [ ] - [FFWD] / [REW]  
EXIT : [INDEX]

PRESS FFWD OR NEW REW KEY TO  
START INDEX SCAN OR 1-99  
AND DIRECTION FOR SEARCH

*Use the Index Menu to Scan or  
Search for Index Marks*

DECK ONE FORWARD SCAN

DECK ONE REVERSE SEARCH

INDEX: 03

### Index Scan

- 1 Insert a tape containing recordings in either deck.
- 2 Press **[INDEX]**. The DECK ONE INDEX or DECK TWO INDEX menu will appear.
- 3 Press **[FF]** to scan for Index Marks forward, or **[REW]** to scan for Index Marks in reverse. The deck will play a few seconds of tape at each Index Mark, then continue on to the next Index Mark.
- 4 Press **[STOP]** (or **[PLAY]**) when you reach the desired Index Mark.

### Index Search

- 1 Insert a tape containing recordings in either deck.
- 2 Press **[INDEX]**. The DECK ONE INDEX or DECK TWO INDEX menu will appear.
- 3 Use the number buttons to enter the number of Index Marks you want the system to count before it stops and plays the tape (enter a "0" first for Index Marks 1-9).
- 4 Press **[FF]** to search for Index Marks forward, or **[REW]** to search for Index Marks in reverse. When the system counts the indicated number of Index Mark, it will stop and play the tape.

### Automatic Show Finder

Automatic Show Finder combines the Date/Time Stamp with the VHS Index Search System (VISS) to ensure you never misplace a recording. Here's how it works:

- 1 Record the Date/Time Stamp at the beginning of all your recordings (see page 29).
- 2 Scan for Index Marks (see above). When the VCR finds an Index mark, it plays the tape for 5 seconds, so you can view each Date/Time Stamp and easily locate your recording.



# Advanced Connections

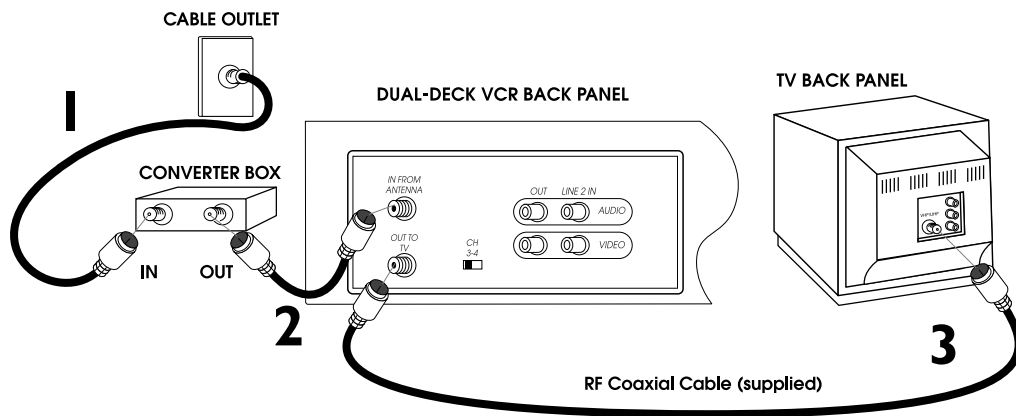

## Cable Converter Box Hookup

Use this hookup if you have a converter box with your cable system and you want to watch and record any cable channel to which you subscribe. *Note:* You will not be able to watch a second channel while recording a cable channel.

- 1 Connect the Cable to your Converter Box** - Attach the cable that comes out of your wall to the input connection on the back of your cable converter box.
  - 2 Connect the Converter Box to your VCR** - Attach the cable supplied with your cable converter box from the output connection on the back of your cable converter box to the ANTENNA IN connection on the back of your VCR.
  - 3 Connect the VCR to your TV** - Attach the supplied RF Coaxial Cable from the OUT TO TV connection on the back of the VCR to the VHF IN or CABLE IN connection on the back of your TV.
  - 4 Turn on the Power** for your VCR, TV and converter box.
  - 5 Set the Channel** on the front display panel of your Dual-Deck VCR to 2, 3 or 4. Call your cable company to find out which of these channels to use.
- Note:* With this hookup you must always keep your Dual-Deck VCR tuned to the same channel, and use the converter box to change channels (even for Timer Recordings).
- 6 Set the VCR back panel switch** to channel 3 or 4, choosing the one that you did NOT use for your cable system in step 5.
  - 7 Set your TV** to the same channel used in step 6 above.

## Alternative Cable Converter Box Hookup

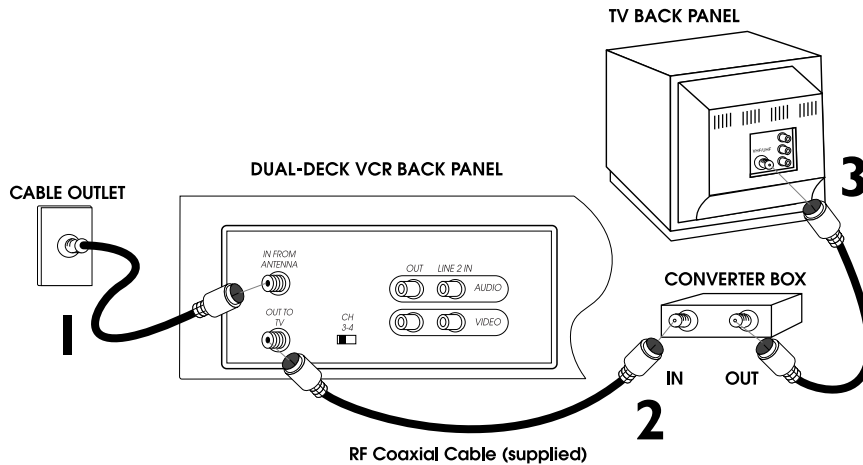

Use this hookup if you have a converter box with your cable system and you want to be able to watch a second channel while recording a TV program. *Note:* With this hookup you can watch scrambled channels, but you won't be able to record them.

- 1 Connect the Cable to your VCR** - Attach a coaxial cable from the outlet in your wall to the ANTENNA IN connection on the back of your Dual-Deck VCR.
- 2 Connect the VCR to your Converter Box** - Attach the supplied RF coaxial cable from the OUT TO TV connection on the back of your Dual-Deck VCR to "Input" on the back of your cable converter box.
- 3 Connect the Converter Box to your TV** - Attach an RF Coaxial Cable from the "Output" connection on the back of the converter box to the CABLE IN connection on the back of your TV.
- 4 Turn your TV to channel 2, 3 or 4** - Whichever is used by your cable system.
- 5 With all three devices turned on, Tune your Converter Box to Channel 3** and push the **MENU** key. You should see a menu.
- 6 Set the Language, Clock and Channel Memory** (see pages 15-17). Press **QUIT** to exit the menu system.

*Note:* With TV/VCR on VCR, you should see the channel that the VCR is tuned to. With TV/VCR on TV, you should see the channel that the cable converter box is tuned to.

This hookup requires you to use different procedures for watching and recording TV programs than the procedures described elsewhere in this Dual-Deck VCR User's Guide.

To view any basic or premium channel:

- 1** Set your Dual-Deck VCR's TV/VCR selector to TV (or turn off your VCR).
- 2** Set the TV to channel 2, 3 or 4, whichever is used by your cable system.
- 3** Select the desired channel to view on the cable converter box.

To record and view a basic channel:

- 1** Set the TV/VCR selector to VCR on your Dual-Deck VCR.
- 2** Set the TV to channel 2, 3 or 4, whichever is used by your cable system.
- 3** Set the cable box to channel 3 or 4, whichever is used as your VCR output.
- 4** Select the desired channel to view on the Dual-Deck VCR. Start the recording (see page 27).

To record a basic channel while watching any other basic or premium channel:

- 1** Set the TV/VCR selector to VCR on your Dual-Deck VCR.
- 2** Set the TV to channel 2, 3 or 4, whichever is used by your cable system.
- 3** Set the Dual-Deck VCR to the channel you wish to record. Start the recording (see page 27).
- 4** Set the TV/VCR selector on the VCR to TV.
- 5** Use the cable converter box to select the channel you want to watch.

## Audio Connections

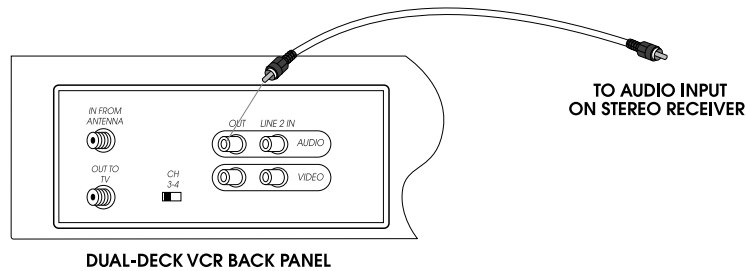

### Listen to TV and VCR Audio on your Stereo System

You can connect your Dual-Deck VCR to your stereo system and hear tapes and TV programs with improved sound quality.

- 1** Attach an RCA cable from the Audio Out jack on the back of your Dual-Deck VCR to one of the Audio In jacks on your stereo receiver.
- 2** On your stereo receiver, select the appropriate input ("VCR", "Tape" or "Aux").
- 3** Turn on your Dual-Deck VCR, TV and stereo system and enjoy improved sound quality with your TV programs and prerecorded movies.

**I**f you have a stereo TV with separate audio input jacks, you can connect the Dual-Deck VCR audio output to one of your stereo TV inputs and enjoy improved sound quality.



## Monitor Connections

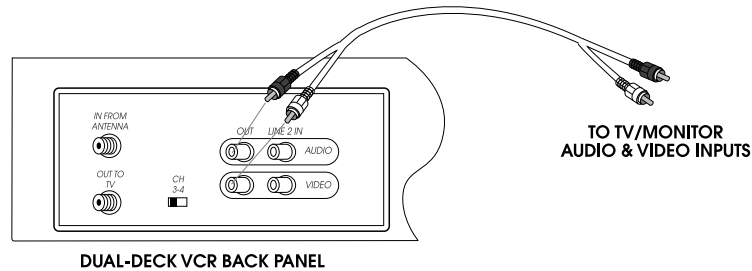

### Enjoy Improved Picture and Sound Quality

Monitor style TVs offer improved picture and sound quality over standard TVs because they receive the video and audio signal directly from the VCR.

If you have a monitor style TV, or if your TV has separate video and audio input connections:

- 1 Attach RCA cables from the Rear Audio and Video Outputs on the back of your Dual-Deck VCR to the Audio and Video Inputs on your monitor TV.
- 2 To view the VCR output on the monitor, switch the monitor to "Video," "Aux" or "Line." Refer to your monitor's owner's manual for the correct setting.

#### Notes:

- When you use the Rear Audio and Video Outputs instead of the OUT TO TV connection, the **TV/VCR** button has no effect. But it still switches the antenna to any device attached to OUT TO TV.
- A monitor style TV is not the same as a computer monitor.

## Connecting Other Video Equipment

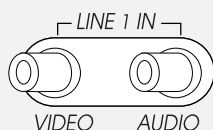
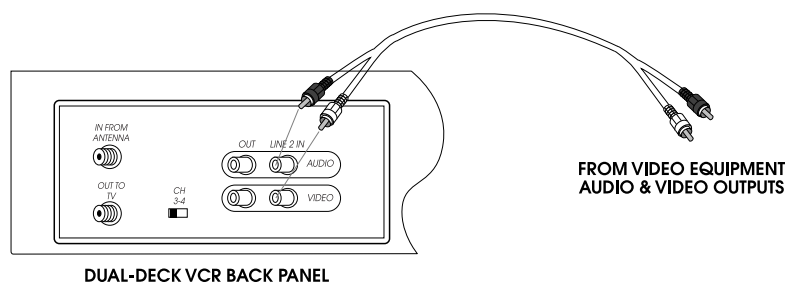

The Front Panel Audio/Video Inputs are ideal for connecting a Camcorder or Video Game.

You can connect a variety of additional video equipment to your Dual-Deck VCR, including:

- Another VCR
- Laser Disc Player
- Video Camera
- Camcorder
- Satellite Receiver
- Video Game
- & more!

**1 Connect the Video Equipment to your VCR** - Attach RCA cables from the A/V outputs on the additional video equipment to the A/V inputs on the front or rear of your VCR. The front inputs are well suited for temporary connections, such as camcorders or video games, while the rear inputs work well for more permanent connections.

**2 To Watch** the input from other video equipment, select Line 1 (Front) or Line 2 (Rear) with the **TVVIEW** button.

**3 To Record** from other video equipment, select Line 1 or Line 2 as the Record Source and press **RECORD**.

**4 To Timer Record** from other video equipment, select Line 1 or Line 2 as the Record Source in the Timer Record Menu (LINE1 or LINE2 will appear on the On-Screen Display in place of the channel number).

**5 To Record from a Camcorder**, set the camcorder to Play mode. Select Line 1 or Line 2 as the Record Source and press **RECORD**.

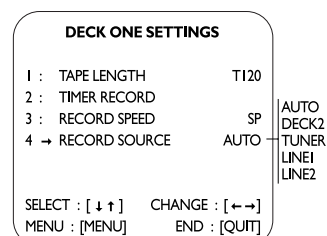

Set the Record Source to Line 1 or Line 2 to record from other video equipment

**Y**ou can connect other video equipment to the front and rear inputs and make two recordings at the same time.



# Helpful Information

## Frequently Asked Questions

"I'm not getting a picture."

---



Make sure the TV/VCR selection is set to VCR (the VCR icon on the Front Panel Display should be on). If not, you can select TV/VCR with the remote control or the button on the front panel. Also make sure your TV is set to the same channel (3 or 4) as the switch on the back of your VCR.

"The picture is bad."

---

If the picture is bad while watching the VCR and your TV is set to channel 3 or 4, try adjusting the fine tuning on your TV. You may also try changing the output channel of the VCR (if it's set to 3 change it to 4 or vice versa). Then make sure your TV is set to the same channel.

If the picture is bad while watching TV on a channel (as opposed to watching the VCR with the TV set on channel 3 or 4), make sure the VCR is in TV mode.

If the picture is bad while playing a tape, try adjusting the tracking control. Use the  (Automatic Tracking) button or the Tracking  &  keys on the remote control. It may be that the video heads are dirty; try cleaning the heads with a nonabrasive head cleaning tape. Remember, you can always check to make sure the tape is OK by playing it in the other deck.

"I can't record from my TV."

---

When the VCR is in VCR mode and your TV is set to channel 3 or 4, you should be able to view the desired channel on your TV. If you have a cable converter box, make sure the VCR is tuned to the cable converter box output channel.

"I can't Timer Record."

---

Make sure that your Dual-Deck VCR's clock is set to the correct time. Double check the AM/PM setting. If you have a cable converter box, make sure the Timer Record channel setting in the TIMER RECORD menu is set to the cable converter box output channel (2, 3 or 4) and the cable box is set to the channel you want to record.

"My remote control isn't working."

---

There are several things which could cause your remote control not to function properly. First, make sure you are aiming the remote control directly at the VCR. Make sure there are no obstacles between the remote control and the VCR so the "beam" is not obstructed. The signal from the remote can sometimes be obstructed if a very strong light source, such as sunlight, falls on the front panel of the VCR. Make sure the batteries in your remote control are fresh and installed properly. Finally, press the VCR key on the remote and try again.

"When I use Copy Tape, my tapes are recorded at a speed other than what was set."

---

In the COPY TAPE SETTINGS menu, check to see if Speed Matching is on. When this feature is on, the recording speed of a copy will be set to the speed of the source tape. If you want to change the speed at which the tape is being copied, turn this feature off.

"When I use Copy Tape or put a tape into record, the tape ejects."

---

Make sure there is a record safety tab on your tape. If the tab is missing, you can place a small piece of transparent tape over the hole. This will allow you to copy or record onto the tape.

"Sometimes the tape begins to play or rewind when I don't want it to."

---

This Dual-Deck VCR can automatically play a tape (with no record safety tab in place) whenever you load it, and it will automatically rewind the tape when it reaches the end. Auto Play can be turned on or off via the Auto Play selection in the VCR SETTINGS menu.

When EZ-COPY in the COPY TAPE SETTINGS menu is on, both decks will automatically rewind before recording when you start a copy tape procedure. This process can be disabled by pushing the STOP key on Deck 2.



"My On-Screen Display has a message that says ERROR."

---

This means the VCR has had difficulty with the tape mechanism. To reset, turn the power off and then on again. If this does not clear the error, unplug the VCR from the wall outlet and inspect both tape slots for foreign objects, or for jammed or crooked tapes.

"Sometimes, I can't Eject a tape using my remote control."

---

If there is scene information in the Scene Edit List from an Automatic Assembly Edit, Deck 1 will not allow you to eject the tape using the remote control. This is because if you eject the tape, you will lose your scene programming. If you still want to eject the tape, you can do so by using the **STOP/EJECT** key on the front panel—this will erase all your Edit List settings—or you can clear all scenes in the Edit List manually.

Remote Eject may not be turned on. See Remote Eject under the VCR SETTINGS menu.

"I can't reset the Deck 1 tape counter."

---

If there is scene information in the Scene Edit List from an Automatic Assembly Edit, you will not be able to reset the Deck 1 tape counter. This is to prevent you from losing your scene programming. To clear unwanted programming, eject the tape from Deck 1 using the front panel Stop/Eject key.

"My VCR doesn't work."

---

A strong static electricity shock or other unforeseen circumstances may cause the control system of your Dual-Deck VCR to lock up. To reset the control system, first unplug the power cord from the wall outlet for 10 seconds and plug it in again. If this doesn't restore all operations to normal, unplug it again for 15 minutes. You will then need to reset the clock (if the clock is still set, you haven't unplugged it long enough). If these steps do not correct the problem, the Dual-Deck VCR must be serviced by an authorized service center.

"I can't bring up the Edit List assembly menu."

---

The VCR must have a tape in Deck 1 for the Edit List to appear because a tape is required to do any editing. Edit List is not available during Copy Tape.

"Why aren't the Counters moving?" \_\_\_\_\_

If the VCR is playing an unrecorded or blank tape, the counter cannot operate. The VCR relies on the control track that is always recorded onto the video tape to provide counter information.

"Why can't I get a Menu or an On-Screen Display?" \_\_\_\_\_

If the VCR is playing an unrecorded or blank tape, the VCR cannot produce on-screen data to be displayed. Stop the tape or record on it to allow the On-Screen Display to resume. It may be that your remote is set to control the TV instead of the VCR. Press the VCR button on your remote to reactivate it. Finally, if the Date/Time Stamp is set to CONT (Continuous) and recording is in progress, the On-Screen Display and menu are disabled. Press Stop on the recording deck to restore normal on-screen functions.

"Why do I get a blue screen?" \_\_\_\_\_

If the VCR's tuner cannot receive a normal synchronized signal, it will display a blue screen in its place. Double check your antenna connections or channel setup.

"My Power button is blinking." \_\_\_\_\_

Your Dual-Deck VCR is in Auto Power Off mode. If you press the Power button while rewinding, copying, Timer Recording, One-Touch Recording or using EZ-Copy, your VCR will automatically turn off when that function is completed. Pressing the Power button toggles Auto Power On and Off.

"My Copy Tape button is blinking." \_\_\_\_\_

Any pause (interruption) in the Copy Tape process will cause this button to blink. See Sync Editing on page 35.

# Technical Specifications

VIDEO SYSTEM	1/2-inch VHS system, 4 rotary head helical scanning; FM azimuth luminance; chrominance: converted sub system phase shift
TELEVISION SYSTEM	NTSC-type color signal EIA standard (525 lines, 60 fields)
AUDIO TRACK	Normal: 1 track
TAPE WIDTH	12.7 mm, 1/2 inch
TAPE SPEED	SP: 33.35 mm/s; SLP: 11.12 mm/s
PLAY/RECORD TIME	T-180 tape: SP 3 hours, SLP 9 hours
FF/REW TIME	T-120 tape: 2 minutes 45 seconds
HEADS	<i>Video:</i> DA 4 rotary heads <i>Audio:</i> 1 stationary head <i>Control:</i> 1 stationary head <i>Erase:</i> 1 full track, 1 audio track
VIDEO	<i>Input:</i> FROM ANTENNA ("F"-type) 75 ohms unbalanced, 1 V <sub>P-P</sub> <i>Output:</i> TO TV ("F"-type) 75 ohms unbalanced, 1 V <sub>P-P</sub> <i>Horiz Res:</i> Monochrome, more than 230 lines <i>S/N Ratio:</i> Better than 43 dB
AUDIO	<i>Input:</i> AUDIO IN (RCA) -8 dbm, 47K ohms <i>Output:</i> AUDIO OUT (RCA) -8 dbm, 1.5K ohm <i>TV Tuner:</i> 181 channel frequency synthesized. VHF input Ch 2 - Ch 13. UHF input Ch 14 - Ch 69. VHF & UHF one input. Cable Ch 5A, A-5 through A-1, A-I, J through W+58, W+59 through W+84. 75 ohm unbalanced.  <i>S/N Ratio:</i> Mono = 40 dB
WOW & FLUTTER	0.3% maximum
RF MODULATION	Channel 3 or 4
FREQUENCY RESPONSE	100 Hz - 10KHz (+/- 3 dB), SP mode
POWER REQUIREMENT	120V AC, 60 Hz, 26 watts maximum
CLOCK BACKUP TIME	1 minute
ENVIRONMENT	41-104 F (5-40 C); 10%-75% humidity
WEIGHT/DIMENSIONS	20 lbs. / 534 x 100 x 400 mm (21" x 4" x 15 3/4")

# DUAL-DECK VCR LIMITED WARRANTY

90 days labor  
1 year parts

## Who Provides the Limited Warranty

During the warranty period, the Go-Video Warranty Administrator will honor Dual-Deck VCR service for 90 days labor, 1 year parts from the original date of consumer purchase. See below for Commercial, Industrial or Educational use coverage. Dual-Deck VCR remote controls are warranted for 90 days from the date of purchase.

## Who is Protected

This warranty protects the original consumer owner of this Go-Video product.

## What is Covered and How Long

This warranty covers internal operating parts and service/labor to repair or replace covered parts in this Go-Video product for 90 days labor, 1 year parts, from the date of purchase, defined as follows: (1) Original Consumer Retail Purchase; (2) First Rental Purchase Agreement; or (3) First Lease Purchase Agreement (the "Warranty Period"). Labor and replacement parts supplied during the Warranty Period are covered only for the remaining portion of the original Warranty Period. The Go-Video Warranty Administrator shall have no liability for service under this warranty if non-OEM (Original Equipment Manufacturer) replacement parts are used in the repair of your Go-Video product.

## What the Owner Must Do If Service is Required

If service under this warranty is required, contact the Go-Video Warranty Administrator at (602) 922-0896 to determine the nearest authorized Go-Video service center.

## Other Warranty Coverage

Commercial, Industrial or Educational use has the same warranty coverage as stated in this warranty.

## What are the Exceptions

This warranty does **not** cover: (1) Normal maintenance service, such as video head cleaning. (2) Damage from misuse, abuse neglect or accident, natural disasters or Acts of God. (3) Cabinetry, decorative parts, A/C adapters, knobs or buttons. (4) The foreign country use of this product. (5) Go-Video product which has been electronically or mechanically modified in any way or incorporated into other products. (6) Installation and set-up service adjustments. (7) Owner instruction. Your Owner's Guide provides information regarding operating instructions and user controls. For additional information, contact your authorized Go-Video dealer.

Go Video is not responsible for any shipping, handling or insurance charges.

This Exclusive Limited Warranty excludes all incidental and consequential damages. Some states do not allow the exclusion of incidental and consequential damages, so the above exclusion may not apply to you.

ALL IMPLIED WARRANTIES, INCLUDING IMPLIED WARRANTIES OF MERCHANTABILITY AND FITNESS FOR A PARTICULAR PURPOSE ARE LIMITED IN DURATION TO THE DURATION OF THIS WARRANTY PERIOD. Some states do not allow limitations on how long an implied warranty lasts, so the above limitation may not apply to you.

This Exclusive Limited Warranty gives you specific legal rights and you may also have other rights which vary from state to state.

GO-VIDEO WARRANTY ADMINISTRATOR  
7835 EAST McCLAIN DRIVE, SCOTTSDALE, AZ 85260-1732  
(480) 922-0896 • E-Mail: [custsvc@govideo.com](mailto:custsvc@govideo.com)

# Multi-Brand Remote Setup

## To Control a Compatible TV

To program your VCR remote control to control a specific brand of TV:

- 1** Turn on the TV and point the remote control at the TV.
- 2** Press and *hold down* **TV**, then press the number buttons corresponding to your brand of television:

01 Samsung - Old	13 Mitsubishi
02 Sharp - New	14 Samsung - New
03 Sony	15 Samsung - Latin
04 Magnavox	16 Sharp - Old
05 Sanyo	17 Zenith
06 Goldstar - New	18 Goldstar - Latin
07 RCA/GE	19 Daewoo - Latin
08 Goldstar - Old	20 Sanyo - PAL
09 Toshiba	21 Emerson
10 Hitachi	22 Sharp - PAL
11 JVC	23 Samsung - Latin 2
12 Panasonic	

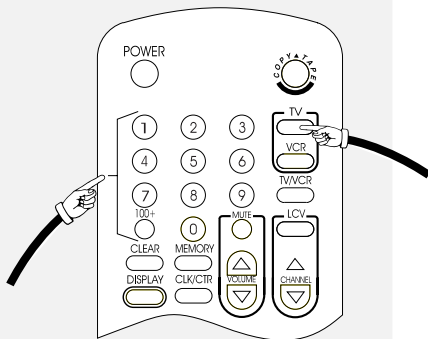

Press and hold down **TV**, then press the 2-digit number for your brand of television.

- 3** When the TV advances to the next active channel, programming is complete. If the TV does not advance to the next channel, repeat step 2 using another 2-digit code.

*Note:* You may want to try all the codes if you have difficulties, as some TVs are not listed but can be programmed.

## Remote Operation

Once you have successfully programmed your Multi-Brand remote control, you can then operate your TV according to the chart below.

*Note:* This remote control may not operate all TVs made by these manufacturers; if your TV does not respond to any of the button combinations, the TV probably cannot be controlled by this remote control.

A **YES** indicates the remote control button works as marked, a **NO** indicates the button does not work. Any other functions are marked (example: for the Sanyo TV, **100+** works for **DISPLAY**).

TV	POWER	0 - 9	100+	CH+	CH-	VOL+	VOL-	DISPLAY	LINEIN
Samsung - Old	NO	YES	YES	NO	YES	YES	NO	YES	
Sharp - New	NO	YES	YES	NO	YES	YES	NO	YES	
Sony	NO	YES	YES	NO	YES	YES	YES	YES	
Magnavox	NO	YES	YES	NO	YES	YES	NO	NO	
Sanyo	NO	YES	YES	DISPLAY	YES	YES	NO	NO	
Goldstar - New	NO	YES	YES	NO	YES	YES	NO	NO	
RCA/GE	ON	OFF	YES	NO	YES	YES	YES	YES	
Goldstar - Old	NO	YES	A-K	NO	YES	YES	NO	NO	
Toshiba	NO	YES	YES	YES	YES	YES	NO	YES	
Hitachi	NO	YES	YES	NO	YES	YES	NO	YES	
JVC	NO	YES	YES	NO	YES	YES	YES	YES	
Panasonic	NO	YES	YES	NO	YES	YES	YES	YES	
Mitsubishi	NO	YES	YES	NO	YES	YES	YES	YES	
Samsung - New	NO	YES	YES	NO	YES	YES	NO	YES	
Samsung - Latin	NO	YES	YES	NO	YES	YES	NO	YES	
Sharp - Old	NO	YES	YES	NO	YES	YES	NO	YES	
Zenith	NO	YES	YES	YES	YES	YES	NO	YES	
Goldstar	NO	YES	YES	YES	YES	YES	YES	YES	
Daewoo	NO	YES	YES	YES	YES	YES	YES	YES	
Sanyo - PAL	NO	YES	YES	YES	YES	YES	YES	YES	
Emerson	NO	YES	YES	YES	YES	YES	YES	YES	
Sharp - PAL	NO	YES	YES	YES	YES	YES	YES	YES	

**W**hen programmed, the Remote Control will always be able to adjust your TV's volume even if it is set for VCR.



# Dual-Deck Index

## A

AmeriChrome™ circuitry 5  
Antenna, Setting the 17  
Assembly Edit, Performing 34  
ATR 25  
Audio Connections 42  
Audio Insert 21  
Audio/Video Inputs 11  
Auto Dimmer 11, 14  
Auto Play 14, 23  
Auto Power On 14  
Auto Rewind 14, 23  
Auto Stop 14  
Automatic Assembly Editing 33  
Automatic Features 14  
Automatic Show Finder 38

## C

Camcorder, Connecting 44  
Channel Memory, Setting 17  
Channel Selection 17  
Channels, Adding 18  
Channels, Deleting 18  
Clock 16, 37  
Complete Program Record 31  
Connections, Advanced 39  
Copy Modes 20  
Copying a Tape 19

## D

Date and Time, Setting the 16  
Date/Time Stamp 29  
Daylight Savings Time 16  
Double-Speed Playback 24

## E

Edit List, Preparing 33  
Editing Tapes 33  
Edits, Making Quality 36  
EZ-Copy 21

## F

Factory Settings, Restore 13  
Features, Dual-Deck 6  
Frame Advance 24  
Frequently Asked Questions 45  
Front Panel Buttons 10  
Front Panel Display 10, 11

## H

Hookup, Alternative Cable Converter Box 40  
Hookup, Basic Antenna/Cable 8  
Hookup, Cable Converter Box 39  
Hookup, Choosing the Right 7

## I

Index Features 37  
Index Scan 38  
Index Search 38  
Initial Settings 15

## J

Jet Search 24

## L

Language, Setting the 15  
Laser Disc Player, Connecting 44  
Loop Play 25  
Loop Record 29

## **M**

Memory Stop 14, 37  
Menu System, On-Screen 13  
Monitor Connections 43  
Multi-Brand Remote, Setup 51

## **O**

On-Screen Display 12  
One Touch Recording 27

## **P**

Picture Search 24  
Play Still Mode 24  
Playback Functions, Special 24  
Playing a Tape 23

## **R**

Record Safety Tab 23  
Record Source 28  
Record Speed 28  
Recording, One Touch 27  
Recording TV Programs 27  
Remote Control 9  
Remote Eject 14, 26

## **S**

Safety Instructions i  
Satellite Receiver, Connecting 44  
Search Features 37  
Separate VHF and UHF antennas 8  
Sequential Play 25  
Sequential Record 29  
Shuttle Keys 24  
Skip Button 24, 36  
Slow Motion Playback 24  
Speed Matching 20  
Sync Editing 35

## **T**

Tape Counter 37  
Tape Length 28  
Technical Specifications 49  
Time Remaining 37  
Timer Record Errors 31  
Timer Record Priorities 31  
Timer Recording 30  
Tracking, Automatic 25  
Tracking, Manual 25  
Troubleshooting 45  
TV View Button 11

## **V**

VHS Index Search System 38  
Video Camera, Connecting 44  
Video Game, Connecting 44

## **W**

Warranty, Dual-Deck Limited 50



# Dual-Deck Menu Tree

Below is a visual flowchart of the Dual-Deck VCR Menu System, indicating the default settings for every menu. Use the number keys (or the up, down, left and right arrow keys) to navigate through the menus.

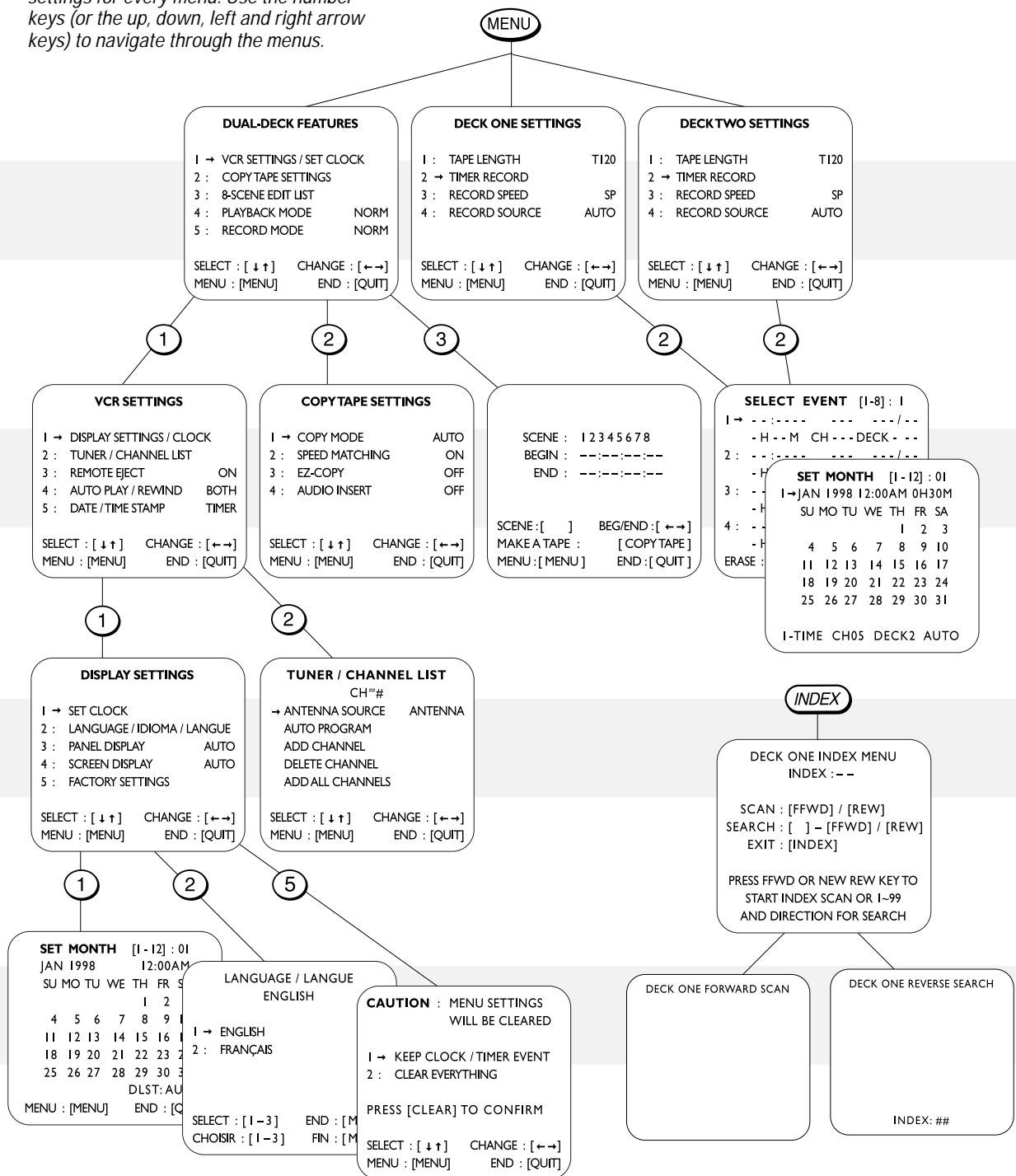



7835 East McClain Drive  
Scottsdale, Arizona 85260-1732  
USA

(480) 998-3400  
E-Mail: [custsvc@govideo.com](mailto:custsvc@govideo.com)

## Free Manuals Download Website

<http://myh66.com>

<http://usermanuals.us>

<http://www.somanuals.com>

<http://www.4manuals.cc>

<http://www.manual-lib.com>

<http://www.404manual.com>

<http://www.luxmanual.com>

<http://aubethermostatmanual.com>

Golf course search by state

<http://golfingnear.com>

Email search by domain

<http://emailbydomain.com>

Auto manuals search

<http://auto.somanuals.com>

TV manuals search

<http://tv.somanuals.com>