

Goodmans

GDB1225DTR Freeview + Digital TV Recorder User Guide

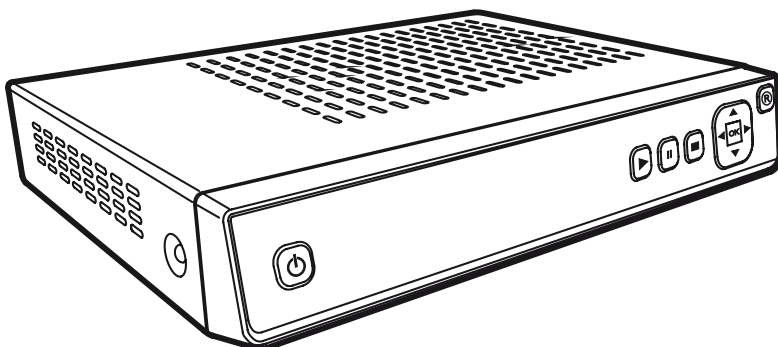

IMPORTANT: Please read all instructions carefully before use and keep for future reference

Introduction

Thank you for choosing this Goodmans Freeview + Digital TV Recorder.

Not only can you receive over 50 digital TV channels, and up to 24 digital radio stations, but you can record two channels at a time, pause live TV and watch it back at a time to suit you.

It's really simple to use; it's all done using the clear, easy to understand on-screen menus which are operated from the remote control. It also has a reminder function so that you won't miss your favourite programmes.

Safety is important

Use of any electrical equipment should be undertaken with care. Please read the safety section on pages 30 and 31 before using the Freeview+ Digital TV Recorder. This appliance is for household use only.



A FREEVIEW Digital Box gives you over 50 digital TV channels and up to 24 digital radio stations, without a subscription or contract. For more information on FREEVIEW, and to check reception in your area please visit www.freeview.co.uk



A digital box lets you access digital channels that are broadcast in the UK. It uses a digital signal, received through your satellite dish and lets you watch it through your existing television.

What's in the box?

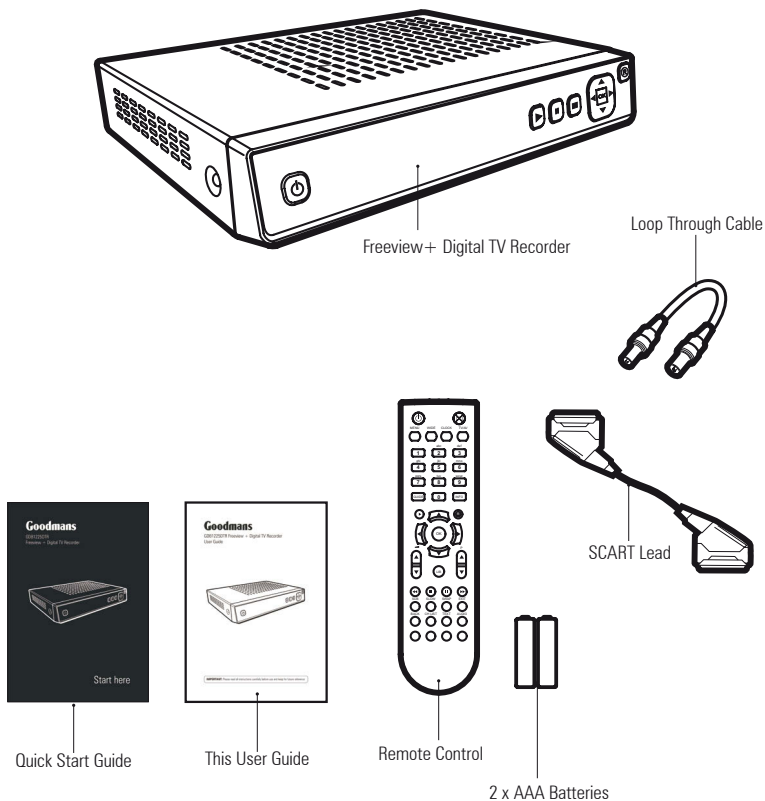

Other things you may need

You will need a wideband rooftop aerial in order for your Freeview+ digital TV recorder to work properly.

See www.digitaluk.co.uk for more information.

Contents

01 Your Digital TV Recorder.....	5	09 The settings menu.....	20
02 Your remote control.....	6	10 Retune	23
03 Connecting up.....	7	11 The system information menu	24
04 Get Started	8	12 Help and Advice.....	25
05 Daily use	10	13 Specifications.....	29
06 The programme guide window.....	14	14 Warnings.....	30
07 Channel Organiser	16	15 Electrical Safety	31
08 The Library Window	18		

Your Digital TV Recorder

01

Front

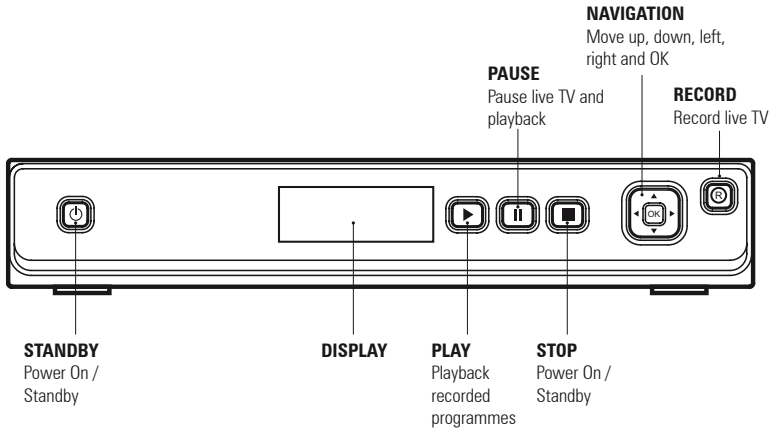

Rear

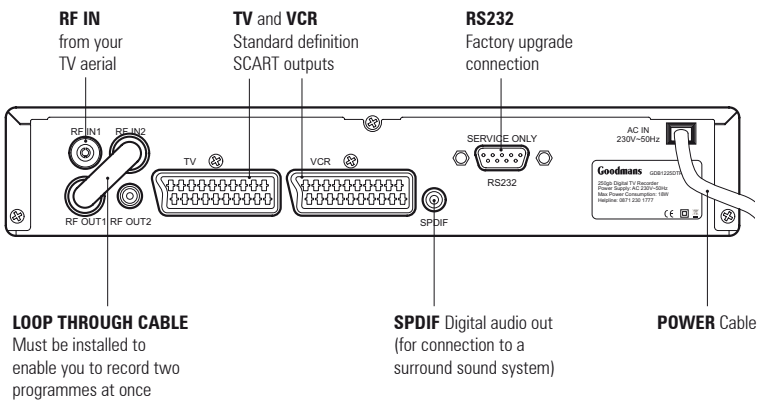

Remote Control

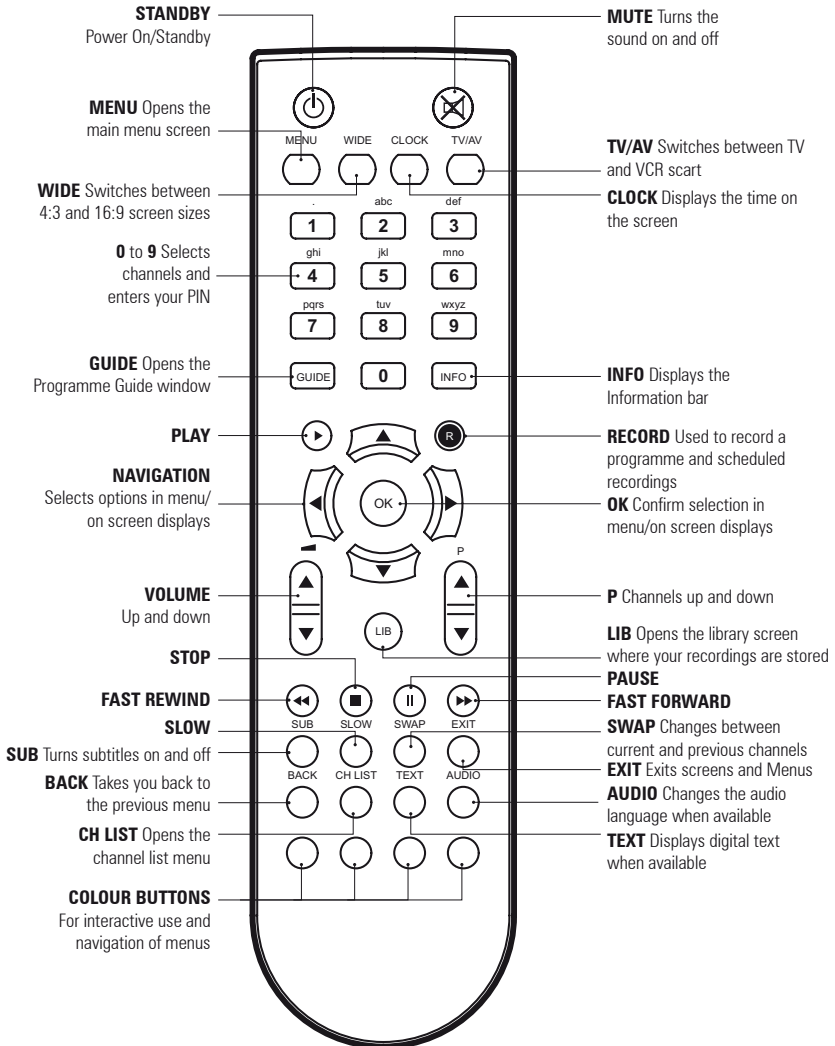

1

Getting connected

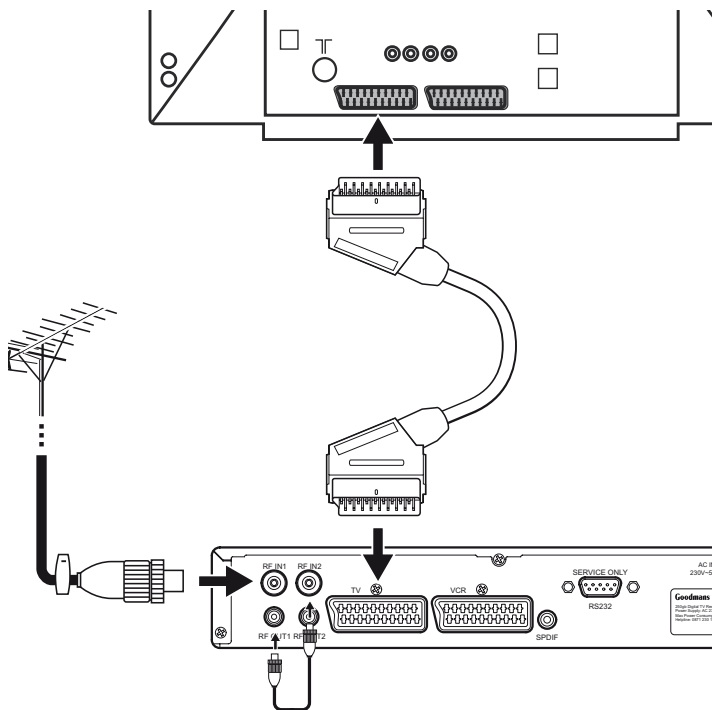

Connect the cable that comes from your aerial to the RF IN socket on the back of your Freeview+ digital TV recorder.

Connect the loop through cable between the RF OUT socket and the RF IN socket (see illustration).

Connect the Scart lead between the TV Scart socket and your TV Scart socket.

2

Using the Remote Control

Open the battery cover of the remote control and put two AAA size batteries so that the '+' and '-' marks on the batteries match the '+' and '-' marks inside the remote control. Replace the battery cover.

To use the Remote Control, simply direct it towards the front of the Freeview+ digital TV recorder and press the desired buttons.

DON'T FORGET! When replacing the batteries make sure that you use the same size and type.

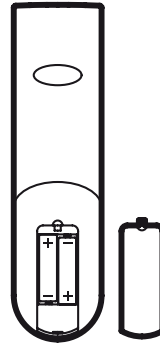

3

Plug in and switch on

Connect the mains plug to the power socket and turn the power **On**.

Switch your TV On.

Press the **STANDBY** button on your remote control.

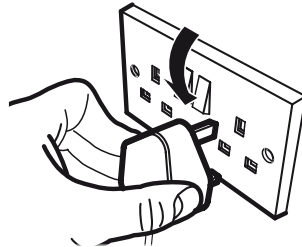

4

To turn on

To turn on your new Freeview+ digital TV recorder, press the **STANDBY** button on the remote control.

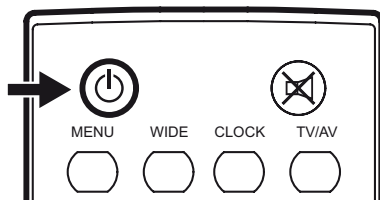

5

The first time install screen

The first time install screen will appear on screen.

Follow the instructions on screen to complete the installation.

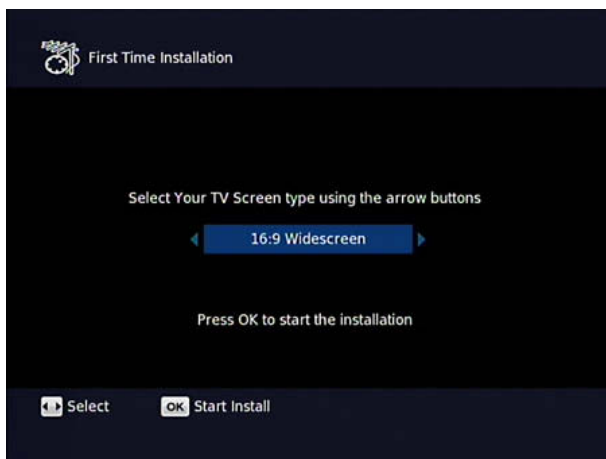

Daily use

We have divided this book into separate sections, so that you can find the information you are looking for easily. This section covers the day to day functions that you will use most often.

Using standby

When you are not watching TV, you should set your Freeview+ digital TV recorder to standby.

Press the **STANDBY** button to switch between on (Standby Indicator green) and standby (Standby Indicator red).

If you plan to leave your Freeview+ digital TV recorder unattended for a long time, put the Freeview+ digital TV recorder in standby and wait 30 seconds before switching it off at the mains.

Choosing a programme

Open the guide by pressing the **GUIDE** button. Use the **▲** and **▼** buttons to select different channels.

When you have chosen your programme, press the **OK** button to watch it.



Changing channel

You can also select the channel you want to watch by using the **P ▲** button and **P ▼** button on the remote control.

Alternatively you can use the number buttons to key the channel number.

When you change the channel the channel information bar will be displayed for a few seconds.

This shows the details of the programme currently showing and the next programme.



Changing the volume

You can change the volume using the **VOL ▲** and **▼** buttons on the remote control.

You can turn off the volume by pressing the **MUTE** button. To turn it back on, press the **MUTE** button again.

The information screen

Press the **INFO** button once to display details of the programme currently being shown and the next programme.

If you want to see information about the programme you are watching, you can press the **INFO** button twice.

Use the **◀** and **▶** buttons to view the current and next programmes.

Audio channel

Sometimes different audio languages are available with certain programmes or channels.

Press the **AUDIO** button to see the available languages.

Use the **▲** and **▼** buttons to select a different audio channel.

Press the **OK** button to confirm the setting.

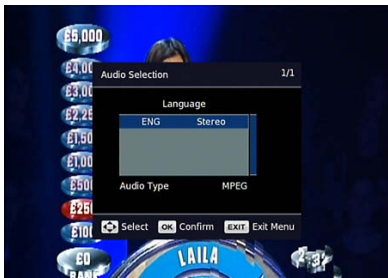

Subtitles

Press the **SUB** button to toggle the subtitles on and off.

DON'T FORGET! Not all programmes have subtitles. You can use the information bar to see if the [S] icon is shown. It's shown in the extended information screen.

Aspect ratio

You can select the aspect ratio or screen size which best suits your TV. The options are 4:3 Normal, 16:9 Widescreen or Auto.

Press the **WIDE** button to toggle between the available aspect ratios.

Output source

Press the **TV/AV** button to switch between TV and the VCR Scart socket output.

Back button

Press the **BACK** button to return to the previous screen or menu.

Clock

Press the **CLOCK** button to view the current time.

Pausing live TV

This function is also known as time shifting and is very useful if you are watching a programme and the phone rings.

To pause live TV, press the **PAUSE** button. The time counter will start and show the amount of time that the programme has been paused.

To continue to watch TV, press the **PLAY** button and the programme will continue from where you paused it.

You can fast forward and fast rewind using the **▶▶** and **◀◀** buttons. The speed and direction are shown on the screen. To change the speed press the **▶▶** and **◀◀** buttons again.

The options are:

▶▶ x2, x4, x8, x16, x32

◀◀ x2, x4, x8, x16, x32

You can watch in slow motion by pressing the **SLOW** button. To change the speed, press the **SLOW** button again.

The options are:

smooth forward 1, 2, 3, 4, 5

smooth rewind 1, 2, 3, 4, 5

To stop time shifting mode and go back to live TV press the **STOP** button.

Digital text

Your Freeview+ digital TV recorder gives you access to digital text for information on news events, weather and a variety of topics.

Digital text services vary depending on the country and channel.

DON'T FORGET! Some channels use the **RED** button to access digital text whilst you are watching TV. When this is available it is identified by a red circle in the top right part of the screen.

Press the **TEXT** button to view digital text. The index page will be displayed.

Use the **NUMBER** buttons to enter a page number or alternatively use the **RED, GREEN, YELLOW** or **BLUE** buttons to access shortcuts.

DON'T FORGET! Many broadcasters include on-screen instructions for using digital text on the index page.

Interactive digital text lets you interact with some TV programmes and channels. If a programme is interactive, the broadcaster's interactive symbol will be on the screen.

The main menu

You can easily access the library, channel organiser and various configuration menus through the main menu.

To open the main menu, press the **MENU** button.

Use the ▲ and ▼ buttons to navigate the main menu.

Press the **OK** button to select an option.

Library - You can open the library window from the main menu. For further information about the library window, see page 18.



Channel Organiser - You can open the channel organiser from the main menu. For further information about the channel organiser, see page 16.

Settings - The settings menu lets you configure the audio and visual settings of the Freeview+ digital TV recorder.

For further information about the settings menu, see page 20.

Retune - The retune menu lets you retune the Freeview+ digital TV recorder. For further information about the retune menu, see page 23.

System Information - The system information menu provides important information about your Freeview+ digital TV recorder.

DON'T FORGET! The system information menu can be accessed by pressing the **MENU** followed by the **0** button.

Swap

Press the **SWAP** button to switch between the current and previous channels.



Navigation

You can open the programme guide window by pressing the **GUIDE** button on the remote control. The guide shows you all of the programmes and channels available for the next 8 days.

Use the **▲** and **▼** buttons to select different channels.

Use the **◀** and **▶** buttons to select the programme.

The **RED** button will move backwards 2 hours (you cannot move backwards before the current time), the **GREEN** button will move forwards 2 hours, the **YELLOW** button will move backwards 24 hours and the **BLUE** button will move forwards 24 hours.

When you have chosen your programme, press the **OK** button to watch it.

Guide icons

[S]	This programme has subtitles
Clock icon	This programme has been set as a reminder
R icon	This programme is scheduled to be recorded

Setting a reminder

You can use the reminder function to let you know when a programme is going to start.

Use the **◀** and **▶** buttons to select a programme.

Press the **OK** button to set the reminder.

When the reminder has been set a clock icon is shown before the programme name.

DON'T FORGET! To cancel a programme reminder, highlight the programme where the reminder has been set, and press the **OK** button. The clock icon will disappear and the reminder will be cancelled.

When the programme is about to start, a warning screen will be displayed. You can change the channel, cancel the reminder or delay the reminder. Use the ▲ and ▼ buttons to select the option and the **OK** button to confirm your selection.

Setting a recording

You can record two programmes at the same time using this Freeview+ digital TV recorder.

Select a programme you want to record and press the **RECORD** button.

If the programme is part of a series and has a series link you will be asked if you want to record the series or the single programme. Use the ▲ and ▼ buttons to select the option and the **OK** button to confirm your selection. When a recording has been set the record icon is shown before the programme name.

DON'T FORGET! You can change channel and watch a programme or recording when the Freeview+ Digital TV Recorder is recording.

Recording Clashes

If you try to record more than two programmes at the same time you will see a warning screen. If you want to continue to set the recording select **YES** with the ◀ button and a list of the recordings will appear.

Use the ▲ and ▼ buttons to select the recording you want to cancel and then press the ▶ button to cancel it. A tick will appear in the delete column.

Press the **OK** button to confirm your selection.

To cancel the new recording, press the **EXIT** button



You can open the channel organiser window from the main menu or with the **CH LIST** button.



This channel list allows you to delete, hide and lock channels.



Channel list icons

	This channel has been hidden
	This channel has been locked and will require the parental PIN to unlock it.

Hiding a channel

You can hide any channel so that it does not appear in the programme guide window and it will not be available when using the **P+** or **P-** buttons. You may want to do this for channels that you do not watch regularly.

Use the **▲** and **▼** buttons to select the channel that you want to hide. Press the **YELLOW** button to hide the channel.

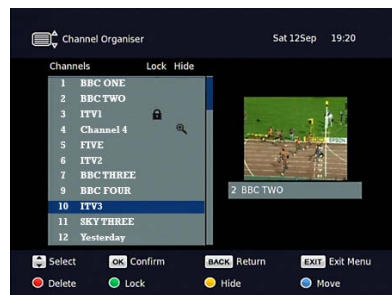

When a channel is hidden, the  will be shown to the right side of the channel name.

DON'T FORGET! Hidden channels will not be shown in the programme guide window.

You will only be able to view the hidden channels using the number buttons.

To show a channel, use the **▲** and **▼** buttons to select the channel that you want to show. Press the **YELLOW** button. The  will no longer be shown and will be available in the programme guide window again.

Locking a channel

You can lock any channel so that it can only be accessed once the parental PIN has been successfully entered. You may want to do this to prevent children from viewing unsuitable programmes.

Use the ▲ and ▼ buttons to select the channel that you want to lock. Press the **GREEN** button. The lock code window will appear.

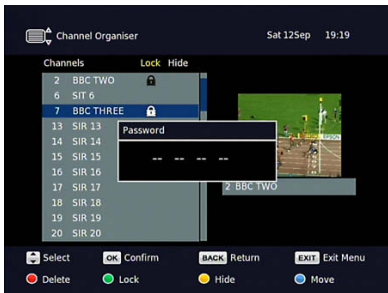

Use the **NUMBER** buttons to enter the parental PIN and then press the OK button. The **LOCK** icon will be shown at the right hand side of the channel name.

DON'T FORGET! The default parental PIN is 0 0 0 0. If you have forgotten your guidance PIN, please contact the call centre on 0871 230 1777 for assistance.

To unlock a channel, use the ▲ and ▼ buttons to select the channel that you want to unlock and then press the **GREEN** button.

The lock code window will appear again. Use the **NUMBER** buttons to enter the parental PIN and then press the **OK** button. The **LOCK** icon will no longer be displayed.

Deleting a channel

You can permanently delete a channel from the channel list. Use the ▲ and ▼ buttons to select the channel you want to delete. Press the **RED** button. A warning will appear asking you if you want to delete the channel. Use the ◀ and ▶ buttons to select YES or NO, then press **OK**.

DON'T FORGET! you will need to do retune to get back any deleted channels.

Moving a channel

You can move the position of a channel in the channel list. Use the ▲ and ▼ buttons to select the channel you want to move. Press the **BLUE** button and the highlight on the selected channel will change colour. Use the ▲ and ▼ buttons to move the channel in the channel list. When the channel is in it's new position in the list, press the **BLUE** button.

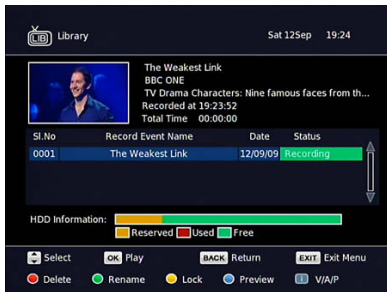

Navigation

You can open the recordings library window by pressing the **LIB** button. This shows you all of your recorded and scheduled programmes.

Use the **▲** and **▼** buttons to select each programme.

Watching a programme

Programmes that have finished recording are marked as **RECORDED** in on a red background in the Status column.

Programmes that are recording are marked as **RECORDING** on a green background in the Status column.

Use the **▲** and **▼** buttons to select a programme you want to watch.

Press the **OK** button to start playback.

DON'T FORGET! You can start to watch back a programme that is recording and don't have to wait for it to finish.

Previewing a recording

You can preview a recorded programme in the preview window in the recordings library. Press the **BLUE** button.

Renaming a recording

To rename a recording press the **GREEN** button. A keypad will appear.

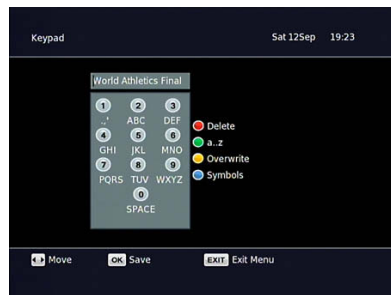

Use the buttons as directed on the keypad to rewrite the programme name as shown at the top of the keypad.

When you have finished press the **OK** button to save the new name and go back to the Library window.

Press the **EXIT** button at any time to go back to the Library window, your changes will not be saved.

Deleting a recording

Use the ▲ and ▼ buttons to select a programme you want to delete. Press the **RED** button to delete.

Locking a recording

You can lock a recording so that it can only be accessed once the parental PIN has been successfully entered. You may want to do this to prevent children from viewing unsuitable programmes.

Use the ▲ and ▼ buttons to select the recording that you want to lock. Press the **YELLOW** button. The lock code window will appear.

Use the **NUMBER** buttons to enter the parental PIN and then press the **OK** button. The  icon will be shown at the right hand side of the Status column.

DON'T FORGET! The default parental PIN is 0 0 0 0. If you have forgotten your parental PIN, please contact the call centre on 0871 230 1777 for assistance.

To unlock a recording, use the ▲ and ▼ buttons to select the recording that you want to unlock and then press the **YELLOW** button. The lock code window will appear again. Use the **NUMBER** buttons to enter the parental PIN and then press the **OK** button. The  icon will no longer be displayed.

HDD information

The HDD information bar shows state of the Hard Disk Drive (HDD).

The **GREEN** part is the amount of free space.

The **RED** part is the amount used by recordings.

The **YELLOW** part is the amount of space reserved for scheduled recordings.

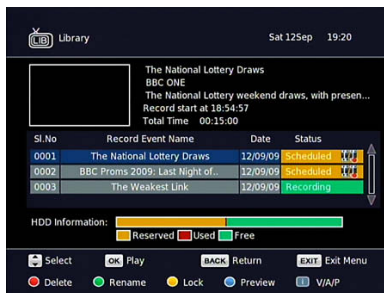

To open the settings menu, press the **MENU** button on the remote control and then select 'Settings'. Press the **OK** button to confirm.



Changing the settings

Use the **▲** and **▼** buttons to select a setting category.

Press the **OK** button and then use the **◀** and **▶** buttons to view the available options for a setting category.

If you want to change a setting, use the **◀** and **▶** buttons to select a setting option.

To exit the settings menu, press the **EXIT** button or alternatively press the **BACK** button to return to the main menu.

Display Settings



Aspect Ratio – You will already have set this as part of the installation process, but you can change the format of the screen size here without having to setup your Freeview+ digital TV Recorder again. You can choose from 4:3 Normal, 16:9 Widescreen and Auto.

Video Output - This setting allows you to choose the video signal type which is sent through the Scart sockets on the rear of the Freeview+ digital TV recorder. Choosing RGB will provide the best picture quality for the majority of TVs. This breaks down the signal into Red, Green and Blue signals. If your TV cannot use RGB, you should choose CVBS. This may produce a reduced picture quality.

OSD Theme – This changes the colours for the On Screen Display. There are three choices Theme 1, Theme 2 or Theme 3. It is a matter of personal choice which one you choose.

Parental lock

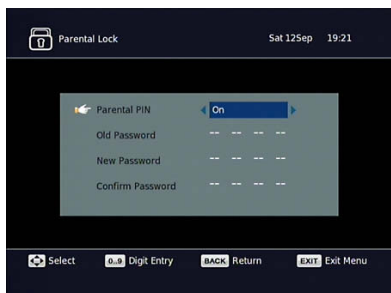

This setting allows you to make changes to the parental PIN. The default setting is that you don't have to enter a PIN (Off).

To change the password you have to enter your old password, enter the new password and then confirm the new password.

DON'T FORGET! The default PIN is 0 0 0 0. You will need to enter the current parental PIN before you are allowed to change it. If you have forgotten your PIN, contact the helpline for assistance.

Factory Reset

This setting allows you to reset all your settings and perform a first time installation. For more information on first time installations, see page 9 or refer to the quick start guide.

DON'T FORGET! By performing a first time installation you will reset all options in the settings menus and cancel reminders.

Preferred Language

This setting is your preferred default subtitle language. The options are English, Gaelic, Irish and Welsh.

DON'T FORGET! Not all programmes have these languages available. If your preferred setting is not available, English language will be used instead.

Format HDD

This setting reformats the HDD



DON'T FORGET! Reformatting the HDD will erase all your previously recorded programmes, including programmes that have been locked.

The retune menu allows you to search for new channels.

DON'T FORGET! You cannot perform a retune whilst recording.

To open the retune menu, press the **MENU** button on the remote control and then select **Retune**.

A warning screen will appear to tell you that all the channels will be retuned.

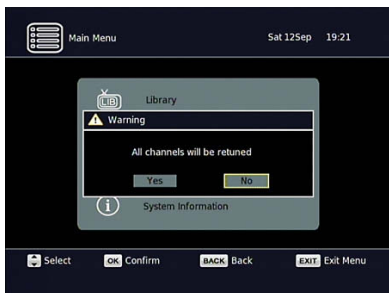

Use the ◀ and ▶ buttons to select **Yes** to retune or **No** to exit Retune.

Select **Yes** and your Freeview+ digital TV recorder will search for all available channels. The progress and signal strength bars are shown for reference.

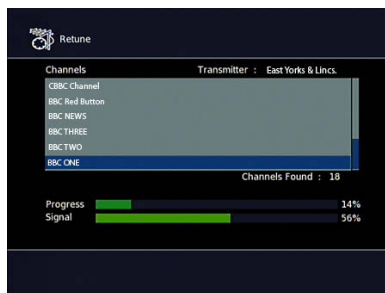

When the retune is complete, the first available channel will be displayed.

To open the system information menu, press the **MENU** button on the remote control and then select 'System Information'. Press the **OK** button to confirm.

The system information menu provides important information about your Freeview+ digital TV recorder.

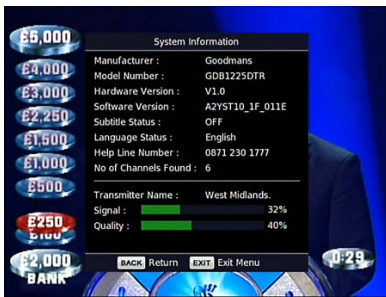

In the unlikely event that you have to contact the helpline, you should have the system information menu open.

DON'T FORGET! The system information menu can be accessed by pressing the **MENU** followed by the **0** button.

Frequently asked questions

Frequently asked question	What you can do
The Freeview+ digital TV recorder will not switch on. What should I do?	Check the mains power cable and make sure it is plugged into a suitable power outlet. Check that the mains supply is switched On. Connect the power cable to a different power outlet.
The Freeview+ digital TV recorder does not seem to work and there is nothing shown on the TV.	<p>Is the Standby Indicator green? If it is not:</p> <ul style="list-style-type: none"> • Press the STANDBY button on your remote control. • Make sure that all cables are firmly connected to the Digital TV Recorder and TV. • Check that the Digital TV Recorder is properly plugged into the power supply. <p>If the standby indicator is green:</p> <ul style="list-style-type: none"> • Check you have the correct channel and input selected on your TV. • Check that all cables are correctly attached. • Check the brightness level of the TV.
The picture appears to be 'squashed' or 'cut off'.	Make sure the aspect ratio settings are suitable for your TV. For more information, see page 20.
I forgot to plug in the aerial when I set up the Freeview+ digital TV recorder. What should I do?	Switch off your Freeview+ digital TV recorder at the mains supply. Plug in the aerial. Switch the Freeview+ digital TV recorder mains supply back on and perform a retune. For more information, see page 23.

Frequently asked question	What you can do
The picture or sound keeps breaking up.	<p>There are several possible causes of this type of problem.</p> <ul style="list-style-type: none">• Your signal may be weak, you may have an old, low performance or damaged aerial, or the cable between your aerial and TV may be damaged. Check for any obvious damage to the aerial and cables and make sure that the connectors are properly fitted. If this does not work, get a professional to check the installation – your aerial may provide a better signal if it is moved somewhere else.• Please remember that older aerials and indoor aerials aren't as effective as new outdoor and roof aerials. Or, try using a signal amplifier or booster to improve the reception. Check the digital TV coverage in your area. For more information about digital TV reception, please visit www.freeview.co.uk.

Frequently asked question	What you can do
<p>No channels were found when searching for channels. I am missing some channels.</p>	<p>Some TV channels are not available in every area.</p> <p>Use the postcode checker on www.freeview.co.uk.</p> <p>Your signal may be weak. Get a professional to check your installation – your aerial may provide a better signal if it is moved somewhere else. Please remember that older aerials and indoor aerials aren't as effective as new outdoor and roof aerials. Or, try using a signal amplifier or booster to improve reception. You may need to scan the digital channels again. For more information on retuning, see page 23.</p>
<p>I cannot see digital channels after I have moved the set top box to a different house.</p>	<p>You will need to retune your set top box. For more information on retuning, see page 23.</p>
<p>I have forgotten my guidance PIN.</p>	<p>Contact the helpline on 0871 230 1777 who will be able to help you reset your PIN. Don't forget to have your system information available. For more information, see page 24.</p>

Frequently asked question	What you can do
<p>The Freeview+ digital TV recorder is behaving in an unusual way, for example, the wrong information is on the screen.</p>	<p>Press the STANDBY button on your remote control to turn the Freeview+ digital TV recorder off and then on again. If there is no improvement, put the Freeview+ digital TV recorder in standby, switch it off at the mains and leave it for 10 seconds before switching it back on.</p> <p>If this does not solve the problem, contact the helpline on 0871 230 1777 who will be able to help diagnose the problem. Don't forget to have your system information available. For more information, see page 24.</p>
<p>Can I change the audio language for the programme I am watching?</p>	<p>Yes. Some channels broadcast other audio languages. Press the AUDIO button when you are watching a programme to see if other languages are available.</p>

Need any help or information setting up?

You may find the information you are looking for on our web site.
www.thesupportsite.co.uk

or on the freeview website
www.freeview.co.uk

If you still need help or information you can phone our call centre on:
 0871 230 1777

Calls are charged at 10p per minute when called from a BT land line.
 Call charges may vary if using other networks.

General	
Model Number	<ul style="list-style-type: none"> GDB1225DTR
Power Supply	<ul style="list-style-type: none"> 230V AC 50Hz
Power Consumption: Standby Nominal Use	<ul style="list-style-type: none"> < 2W 16W Max
Dimensions	<ul style="list-style-type: none"> 28mm (W) x 55mm (H) x 22mm (D)
Weight	<ul style="list-style-type: none"> 1.5 kg

IMPORTANT: Due to continual revision and improvements to our products design, specifications are subject to change without notice.

Guarantee

The Freeview+ digital TV recorder is guaranteed for twelve months from the date of original purchase. If any defect due to faulty materials or workmanship, contact the Goodmans Helpline. Have your receipt of purchase on hand.

The guarantee is subject to the following provisions:

- It is only valid within the boundaries of the country of purchase.
- The product must be correctly installed and operated in accordance with the instructions contained in this User Guide.
- The Freeview+ digital TV recorder must be used solely for domestic purposes.
- The guarantee will be rendered invalid if the Freeview+ digital TV recorder is re-sold or has been damaged by inexpert repair.
- The manufacturer disclaims any liability for incidental or consequential damages.
- The guarantee is in addition to, and does not diminish, your statutory or legal rights.

WEEE

This appliance is labelled in accordance with European Directive 2002/96/EG concerning used electrical and electronic appliances (Waste Electrical and Electronic Equipment - WEEE). The guideline determines the framework for the return and recycling of used appliances.

General Safety

This Freeview+ digital TV recorder has been designed and manufactured to meet European safety standards, but like any electrical equipment, care must be taken if you are to obtain the best results and safety is to be assured.

Do read these operating instructions before you attempt to use the Freeview+ digital TV recorder.

Do ensure that all electrical connections (including the mains plug, extension leads and interconnections between pieces of equipment) are properly made in accordance with the manufacturer's instructions.

Switch off and remove the mains plug when making or changing any connections.

Do consult your dealer if you are ever in doubt about the installation, operation or safety of your Freeview+ digital TV recorder.

Don't continue to operate the Freeview+ digital TV recorder if you are ever in doubt about it working normally, or if it is damaged in any way. Switch it off withdraw the plug from the mains and consult your dealer.

Don't remove any fixed covers as this may expose you to dangerous voltages.

Don't leave the Freeview+ digital TV recorder switched On when it is unattended for long periods of time, unless it is specifically stated that it is designed for unattended operation or has a standby mode.

Make sure that other people in your household are conversant with the Freeview+ digital TV recorder.

Don't obstruct the ventilation vents on the Freeview+ digital TV recorder, for example with curtains or soft furnishings.

Overheating will cause damage and shorten the life of the product.

Don't allow electrical equipment to be exposed to rain or moisture.

Store the Freeview+ digital TV recorder in a clean, dry environment.

Do not use any cleaning solutions on the Freeview+ digital TV recorder.

This digital TV recorder is fitted with a BS1363/A 13 amp plug. If it is not suitable for your supply sockets it must be removed and replaced with an appropriate plug. If the plug becomes damaged and/or needs to be replaced please follow the wiring instructions below. The plug removed must be disposed of immediately. It must not be plugged into a supply socket as this will be an electrical hazard. If the fuse needs to be replaced it must be of the same rating and ASTA approved to BS1362. If the plug is changed, a fuse of the appropriate rating must be fitted in the plug, adapter or at the distribution board. If the fuse in a moulded plug is replaced, the fuse cover must be refitted before the appliance can be used.

Wiring Instructions

The supply cable will be either 2-core or 3-core. Follow the appropriate wiring instructions given below. In both cases ensure that the outer sheath of the cable is firmly held by the cable clamp.

2- Core plug

⚠ WARNING: Do not connect either wire to the earth terminal.

 This symbol indicates that this 2-core appliance is Class II and does not require an earth connection.

The wire coloured blue must be connected to the terminal marked with the letter N or coloured black.

The wire coloured brown must be connected to the terminal marked with the letter L or coloured red.

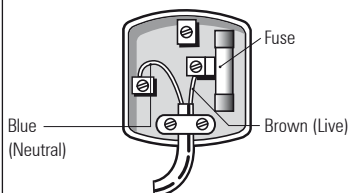

3- Core plug

⚠ WARNING: This appliance must be earthed.

The wire coloured green and yellow must be connected to the terminal marked with the letter E, or by the earth symbol (⏚), or coloured green or green and yellow.

The wire coloured blue must be connected to the terminal marked with the letter N or coloured black.

The wire coloured brown must be connected to the terminal marked with the letter L or coloured red.

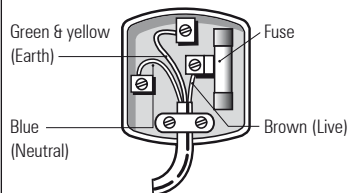

Goodmans

DCS-MAR10-GDB1225DTR

Free Manuals Download Website

<http://myh66.com>

<http://usermanuals.us>

<http://www.somanuals.com>

<http://www.4manuals.cc>

<http://www.manual-lib.com>

<http://www.404manual.com>

<http://www.luxmanual.com>

<http://aubethermostatmanual.com>

Golf course search by state

<http://golfingnear.com>

Email search by domain

<http://emailbydomain.com>

Auto manuals search

<http://auto.somanuals.com>

TV manuals search

<http://tv.somanuals.com>