

# Goodmans

**DAB Portable Radio**

**GSR75WDAB**

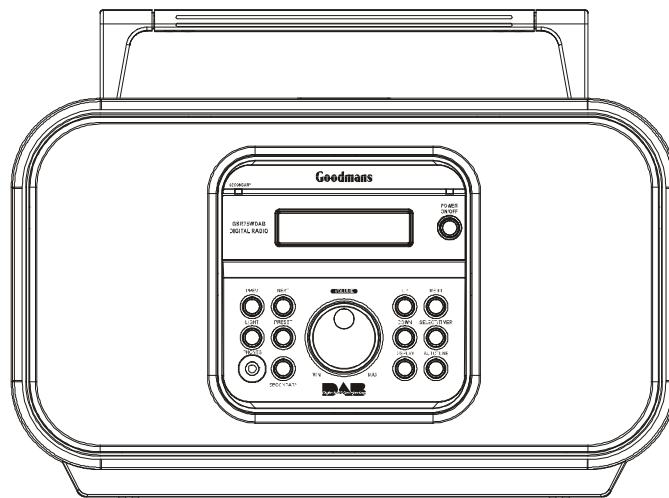

**Instruction Manual**

**Before operating this unit,  
Please read this instruction manual carefully**

**Goodmans Product Information Helpline 0870 873 0080**

## Introduction

Congratulations on your purchase of this latest “state of the art “ Digital Audio Broadcast Radio. Please read through the following pages to get the most out of this GSR75WDAB.

### What’s in the box

On unpacking the unit the following should be located within the packaging

1 x GSR75WDAB Main unit

1 x Detachable mains lead complete with 3 pin fitted plug

1 x Instruction Manual

1 x Quick start Guide

Please retain all packaging materials for use in the event of the product needing transportation or in the unlikely event of the product requiring repair.

## Table of contents

	<b>Page No.</b>
<b>Introduction</b>	<b>2</b>
<b>Important Notes</b>	<b>3</b>
<b>Getting Started</b>	<b>6</b>
<b>Location Of Controls</b>	<b>7</b>
<b>General Operation</b>	<b>8</b>
<b>DAB Operation – (Including Menu)</b>	<b>10</b>
<b>Troubleshooting guide &amp; Specifications</b>	<b>21</b>

**Goodmans Product Information Helpline 0870 873 0080**

## IMPORTANT NOTES

Your hearing is very important to you and to us so please take care when operating this equipment. It is strongly recommended that you follow the listed guidelines in order to prevent possible damage or loss of hearing:

### ESTABLISH A SAFE SOUND LEVEL

- Over time your hearing will adapt to continuous loud sounds and will give the impression that the volume has in fact been reduced. What seems normal to you may in fact be harmful. To guard against this **BEFORE YOUR HEARING ADAPTS** set the volume at a low level.
- Slowly increase the level until you can hear comfortably and clearly and without distortion.
- Damage to your hearing is accumulative and is irreversible.
- Any ringing or discomfort in the ears indicates that the volume is too loud.

**Once you have established a comfortable listening level, DO NOT INCREASE THE SOUND LEVEL FURTHER.**

The following list of typical sound levels may assist you in recognising just how loud you have set the volume level.

### DECIBEL

Level dB                      Example

30dB	Quiet library, soft whisper.
40	Living room, fridge freezer bedroom away from traffic.
50	Normal conversation, quiet office, light traffic.
60	Electric sewing machine,
70	Vacuum cleaner, hair dryer, noisy restaurant

### THE FOLLOWING NOISE CAN BE HARMFUL UNDER CONSTANT EXPOSURE

80dB	Average city traffic, alarm clock buzzer at 2 feet, food mixer.
90dB	Motorcycle, heavy goods vehicle, petrol lawn mower.
100	Pneumatic drill, chain saw, garbage truck, discotec / nightclub.
120	Rock band concert, thunderclap.

### PERMANENT LOSS OF HEARING

140	<b>THRESHOLD OF PAIN</b> Gunshot 2 feet away.
180	Rocket Launching pad.

**Goodmans Product Information Helpline 0870 873 0080**

## IMPORTANT NOTES (Contd.)

### IMPORTANT SAFEGUARDS

#### PRE FITTED MAINS PLUGS

For your convenience a mains plug has been fitted to this appliance. For your safety please observe the following information

1. Should the fuse in the plug remove the plug from the wall socket and replace the fuse with a 3 Amp ASTA approved to BS 1362 fuse.
2. Never use the plug without the fuse cover fitted. Replacement fuse covers are available from your dealer or most electrical retail outlets.
3. If the cable of the mains plug is cut off the cable, rewire the replacement plug in accordance with instruction given in this manual.
4. CAUTION: Under no circumstances should the discarded plug be inserted mains socket. To prevent a shock hazard carefully dispose of the discarded plug. Do not leave the plug lying around where children might see it.

**WARNING:** To prevent fire or shock hazard do not expose this unit to rain or moisture.

**CAUTION:** DANGEROUS VOLTAGES EXIST INSIDE THIS UNIT, DO NOT REMOVE COVER (OR BACK). NO USER SERVICEABLE PARTS INSIDE. REFER SERVICING TO QUALIFIED SERVICE PERSONNEL. DISCONNECT FROM MAINS SUPPLY WHEN NOT IN USE.

#### PLUG WIRING DETAILS

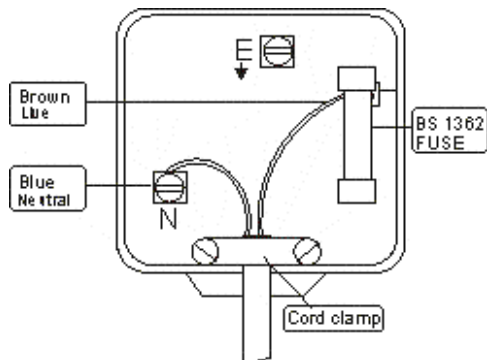

The wires in this mains lead are coloured in accordance with the following wiring codes:

Blue ..... Neutral  
Brown ..... Live

The wires in this mains lead must be connected to the terminals in the plugs as follows:

Blue Wire.....N or Black  
Brown Wire ..... L or Red

Only a 3 Amp fuse should be fitted in the plug or a 5 Amp fuse at the distribution board.

**WARNING:** UNDER NO CIRCUMSTANCES MUST THE LIVE OR NEUTRAL WIRES BE CONNECTED TO THE EARTH TERMINAL IN A 3-PIN MAINS PLUG.



This symbol means that this unit is double insulated. An earth connection is not required.

**Goodmans Product Information Helpline 0870 873 0080**

## IMPORTANT NOTES (Contd.)

### SOME DO'S AND DONT'S ON THE SAFE USE OF EQUIPMENT

#### WARNING:

This equipment has been designed and manufactured to meet European safety standards but like any electrical equipment, care must be taken if you are to obtain the best results and safety is to be assured.

Do read the operating instructions before you attempt to use the equipment.

Do ensure that all electrical connections (Including the mains plug, extension leads and interconnections between pieces of equipment) are properly made in accordance with the manufacturer's instructions. Switch off and withdraw the mains plug when making or changing connections.

Do consult your dealer if you are ever in doubt of the installation, operating, or safety of your equipment.

Don't continue to operate the equipment if you are in any doubt about it working normally, or if it is damaged in any way- switch off, withdraw the mains plug and consult your dealer.

Don't remove any fixed covers as this may expose dangerous voltages.

Don't leave equipment switched on when it is unattended unless it is specifically stated that it is designed for unattended operation or has a standby mode. Switch off using the switch on the equipment and make sure that your family knows how to do this. Special arrangements may need to be made for infirm or handicapped people.

Don't listen to headphones at high volume, as such use can permanently damage your hearing.

Don't obstruct the ventilation of the equipment, for example with curtains or soft furnishings.

Overheating will cause damage and shorten the life of the equipment.

Don't allow electrical equipment to be exposed to rain or moisture.

#### **Above all**

Never let anyone, especially children, push anything into holes, slots or any other opening as this could result in a fatal electric shock.

Never guess or take chances with electrical equipment of any kind.

It is better to be safe than sorry!

TO REDUCE THE RISK OF FIRE OR ELECTRIC SHOCK, DO NOT EXPOSE THIS APPLIANCE TO RAIN OR MOISTURE, DANGEROUS HIGH VOLTAGES ARE PRESENT INSIDE THE ENCLOSURE, DO NOT OPEN THE CABINET, REFER SERVICING TO QUALIFIED PERSONNEL ONLY.

## Getting Started

### Power Sources

The GSR75WDAB can be powered either directly from the household 230V AC mains Supply via the supplied lead or from 4 D size batteries (not Supplied)

#### ▪ AC MAINS

Insert the small end of the AC mains lead to the socket on the side of the GSR75WDAB and the 3 pin plug into a switched household AC supply socket, ensure the wall outlet socket is switched ON. The display will now illuminate indicating power is reaching the unit. Press the standby button to switch the unit on.

**Note:** Whilst using the AC supply the battery supply is disconnected automatically.

#### ▪ BATTERY OPERATION

**WARNING:** Ensure that the battery charge switch located on the left side of the radio is switched OFF. Charging of non re-chargeable batteries will damage the unit and may also result in the batteries exploding.

Remove the Battery Compartment cover and insert 4 x LR20 (D Size Alkaline batteries), observing the correct polarity replace the cover.

**NOTE: BE SURE TO MATCH THE POLARITIES AS SHOWN BELOW.**

NOTE: Old batteries may swell and leak. To avoid damage to the unit, remove the batteries when the unit is to be stored for long periods of time, or if the batteries become exhausted (the display will fade and the power/standby LED will flash if the batteries are becoming exhausted). And if radio sound is low or distorted, the batteries probably need replacing.

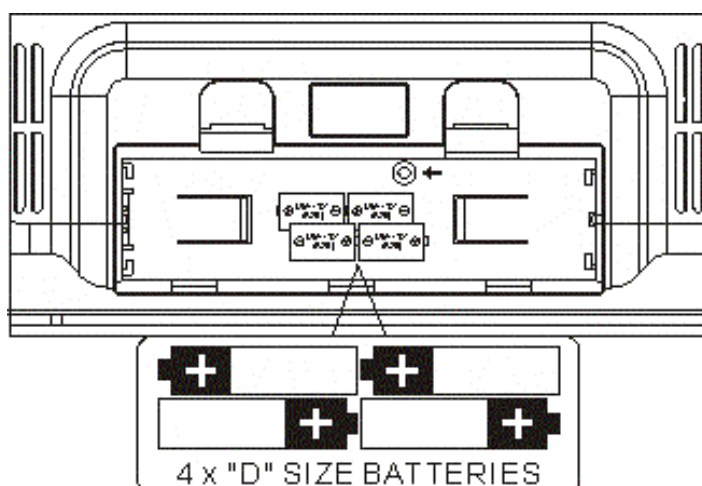

**Goodmans Product Information Helpline 0870 873 0080**

## Location of controls

### Front

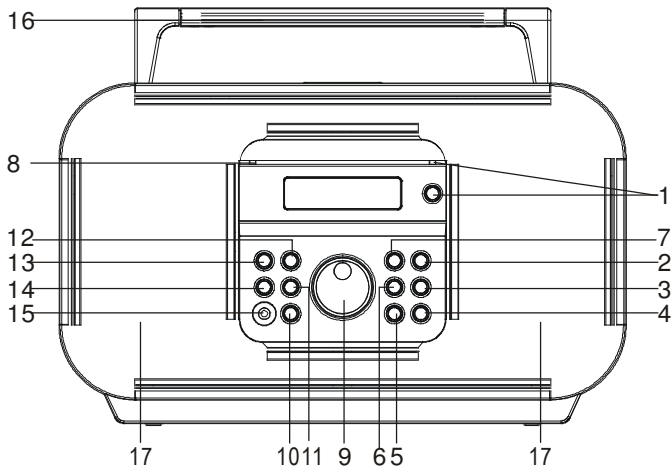

1 Power button and indicator LED

2 Menu button

3 Select button

4 Autotune button

5 Display Button

6 Down button

7 Up button

8 Secondary DAB service indicator

9 Rotary Volume control

10 Secondary button

11 Preset button

12 Next

13 Previous

14 Light button

15 3.5mm Headphone socket

16 Folding Handle

17 Left and Right Speakers

### Side

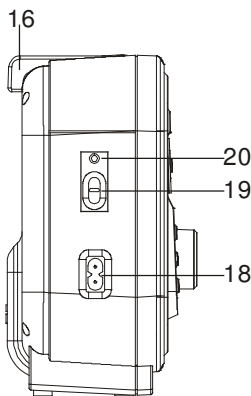

18 AC input socket

19 Charge ON/OFF switch

20 Charge ON indicator

21 Stereo RCA output sockets

### Rear

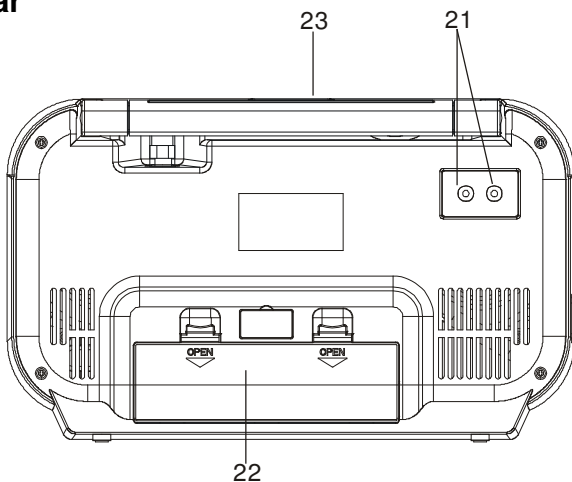

22 Battery Compartment

23 DAB telescopic rod aerial

**Goodmans Product Information Helpline 0870 873 0080**

## General operation

DAB or Digital Audio Broadcasting represents a new age in broadcasting technology and as with all new technologies it is significantly different to traditional Analogue FM/AM broadcast methods. The new system no longer relies on tuning to a given frequency but instead allows the DAB receiver to provide an active Station List of all available radio programmes/stations at the touch of one button. Station Lists are described in more detail in the DAB Operation section of this manual.

Before selecting the DAB function for the first time please ensure the telescopic rod aerial is fully extended and upright.

1. Connect the unit to the household mains supply or insert 4 D size batteries(not Supplied)
2. Press the Power button on the front panel
3. The unit will automatically start a scan of the DAB services and after 15 to 20 seconds the first station in the Station List will begin to playback

**NOTE:** At this stage it is possible that the display may show “No DAB service” on the first line of the display and “Check Aerial?” on the second line of the display. This indicates the unit has been unable to locate any available DAB stations during the search process.

This may be due to :-

- a. No DAB stations in the local area Check with the DRDB at [www.DRDB.org](http://www.DRDB.org) or call the reception Helpline on 08707 747474
  - b. The radio needs relocating to a better location in order to get adequate reception. The signal strength indication (See Display button operation) can be used to assist this process.
4. Assuming there is now a Station List available the other stations on the list can be located
    - a. **Directly** - use the Next /Previous buttons or
    - b. **Indirectly** (i.e. listen to the current station until the required next station is shown on the bottom line of the 2 line display) use the Up/down buttons then press the select button (pressing and holding the up or down button will scroll the list at a faster rate)
  5. Use the Volume control to increase or decrease the sound output level as required.

### Important Reminder for DAB Reception

Please be reminded that this unit is specifically designed for reception of UK only DAB stations restricted to Band 3 (11B to 12D) only it will therefore **NOT** receive DAB stations in European areas that broadcast on L band

**Goodmans Product Information Helpline 0870 873 0080**



## General operation (contd.)

### Power Off

To switch the radio OFF press the “Power” button

Note: in this state the radio will still show the clock in the display and draw a small amount of power from either the batteries or the AC mains supply.

### Connecting to an External Amplifier

The audio output from this unit can be played back through an external amplifier. Connect the two RCA line output sockets on the rear of the unit to suitable line input sockets on an external amplifier or Audio equipment with a Twin RCA Phono lead (not supplied).

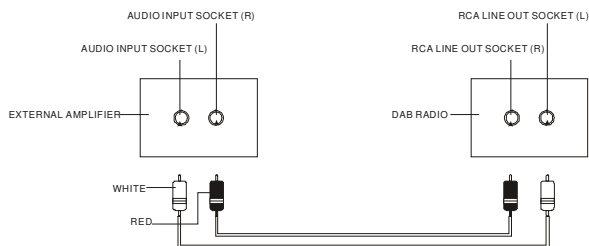

### Headphones

A stereo headphone socket is provided for private listening. Connect a pair of low impedance (8-16 ohm) headphones or earphones (not supplied) with a 3.5mm stereo jack plug. When headphones are connected the main speakers are automatically disconnected.

### Backlight

Your receiver includes an advanced display, with a backlight to aid viewing in all conditions. This backlight has two levels of brightness: “Hi” and “Lo”. In normal operation (on AC Mains Supply,) the backlight is switched to Lo, when any button is pressed the illumination will increase to Hi for 10 seconds after which it returns to Lo. When using batteries, the backlight is normally off (in order to preserve battery life) unless any button is pressed when it changes to Hi for 10 seconds then back to off.

### Re-Charging Batteries

**WARNING:** Do not charge non rechargeable batteries in this player. Danger of explosion is possible.

The preferred rechargeable battery type to use are NIMH D size. They do not suffer from poor charge memory problems after being in use for some time.

1. A fully charged battery depending on its capacity will take approximately 15 hours for a full charge.
2. Charging of the batteries is possible with the radio powered on or off as long as it is connected to the mains supply.
3. Insert 4 x D size rechargeable batteries into the battery compartment observing the correct polarity as indicated inside the battery compartment.

**Goodmans Product Information Helpline 0870 873 0080**

## DAB operation

4. With the radio connected to a mains supply move the charge switch to its ON position. The Charge red LED indicator will illuminate and remain illuminated when this switch is in the ON position.
5. After approximately 15 hours move the charge switch to its OFF position. The charge indicator will extinguish and charging of the batteries will no longer take place.
6. Remove the mains cable from the side of the radio to operate the radio from the batteries. Reconnecting of the mains cable to the radio will bypass the batteries.

Note: The charge current in this player has been optimised for over night charging of NI-MH rechargeable batteries. Nicad batteries can be used but the charge time will need to be reduced.

### DAB Overview

DAB Radio tuning is very different to traditional analogue radio tuning. In DAB mode the user is not required to know anything about station frequencies.

Instead an organised list of the DAB radio stations receivable in the current location is created by the radio. This list is initially organised into alphabetical order (by the first letter of the station name only).

The “Autotune” function is the system that the DAB radio uses to create this list of available stations.

This list would be organised in the following way :-

**TOP**A-Example Station>B-Example Station>C-Example Station>D-Example Station>

E-Example Station>F-Example Station>G-Example Station>H-Example Station **Bottom**

After Autotune has completed the radio will automatically tune to the top station in the Station List. In the fictional Station List above this would be “A-Example Station”.

This radio provides two different ways of selecting stations from the list it has created.

Using the “Up”, “Down”, and “Select” buttons – as described later in this manual

Using the “Prev” and “Next” buttons – as described later in this manual.

When using these buttons to select stations the list is cyclic. Using the above list as an example this means that if the selection continues down past “H-Example Station” the next station presented will be “A-Example Station”.

If the same thing is done in the opposite direction i.e. the selection continues up past “A-Example Station” the next station presented will be “H-Example Station”

### NOTE

There is one condition where the Station List is not sorted into alphabetical order.

This is when the “Sort by Favourites” option is switched ON using the “Menu” button as described later in this manual. However the default setting for the unit at initial Power up is as described above

## DAB operation [contd.]

### Button functions

<b>Power</b>	Press to switch ON or switch OFF.
<b>Previous (Prev)</b>	DAB Mode :Go directly to the previous station in the DAB Station List
<b>Next (Next)</b>	DAB Mode :Go directly to the next station in the DAB Station List
<b>Light</b>	DC mode, press once backlight will on 5 second
<b>Presets</b>	Select the Preset list instead of the full list of available stations
<b>Secondary</b>	DAB Mode : This is the Secondary service selection button. Secondary services are sometimes available embedded within the main DAB station currently being listened to. This will be indicated by the Secondary LED on the Front Panel. When the LED is illuminated, press this button repeatedly to cycle through the available secondary services and then back to the original (primary) service.
<b>Menu</b>	Selects the Menu function
<b>Up</b>	Used in DAB tuning and the navigation of the Menu
<b>Down</b>	Used in DAB tuning and the navigation of the Menu
<b>Select/Timer</b>	Used to Select a menu item or radio station displayed on line 2 of the display. Also used to set or cancel the reminder timer function
<b>Display</b>	Each press Cycles the second line of the display to present different information. This can include >scrolling text > signal strength >multiplex and station information>broadcast bit rate>audio mode>clock time>battery level (only when batteries are being used) >scrolling text etc.
<b>AutoTune</b>	If this button is pressed for more than 5 seconds a scan of the DAB band is performed.

**Goodmans Product Information Helpline 0870 873 0080**

# DAB operation

## The Display

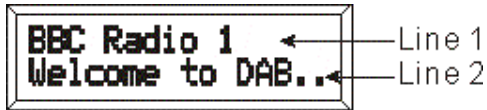

In DAB mode, the name of the station being listened to appears on Line 1 of the display, and the “dynamic text” (sometimes known as “DLS Text”) will appear on Line 2 of the display unless the “Display”, “Up”, “Down”, “Menu”, or “Select/Timer” buttons have been pressed which change the information shown on line 2 of the display.

**Display Button (DAB Mode)** The “Display” button changes the information displayed on line 2 of the display by cycling through the following settings:

Normal (dynamic text for DAB) > Signal Strength > Multiplex and station information (3 items) > broadcast Bit rate>audio mode>Clock time > Battery Level (only if batteries are being used) > Normal (dynamic text for DAB) etc

Each time the “Display” button is pressed, the information displayed on line 2 of the display is changed to one of the above. Continue to press the “Display” button until the required information is displayed. **Note** : Sometimes when listening to DAB, the dynamic text may take a few seconds before it starts to scroll across the display – this is normal.



### Normal (DLS Text)

This is the normal display for DAB mode. The DLS text is almost always longer than the display so it will “scroll” across the display such that all the content can be read.



### Signal Strength

The signal strength is shown as a bar on line 2 of the display – the longer the bar, the stronger the signal. This display can be used when first setting up your receiver to help you position the aerial for best reception



### Multiplex and Station information

Use these options to find out more technical information about the station being listened to.



**BBC National DAB** (the name of the multiplex on which the station is being transmitted)

**160kbits/S** - the bitrate of the audio being received (in the range 64 to 384kbit/s)



**Audio Mode** (the broadcast mode – can be Mono, Stereo, or Joint Stereo)

### Clock



The clock is automatically updated when listening to DAB, and is kept up to date by the receiver when the receiver is switched off. The clock can be displayed in 12-hour (AM/PM) or 24-hour (default) format.

**Goodmans Product Information Helpline 0870 873 0080**

## DAB operation (contd.)

### Battery Level



If the receiver is operating on batteries, the battery level will be displayed, as a bar. The longer the bar, the more life is left in the batteries.



If the receiver is operating on mains power, this message will be displayed:

**Note:** If the battery level is getting low, then the Power LED will start to flash. switch off the receiver and replace the batteries as soon as possible

### Autotune

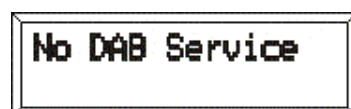

When “No Dab Service” is shown in the display, Press the **Autotune** button perform a scan of the DAB Band 3 UK spectrum and create a new Station List of all available DAB stations currently broadcasting. This process usually takes around 15-20 seconds searching the range (11B-12D) used in the UK During this process, the display will show how many stations have been found, and on what “channel” they were found: The number of stations found varies greatly dependant on the area in which the receiver is located not all stations are available in all areas

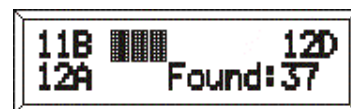

Once the autotune function has completed the receiver will tune to the first station in the Station List.

A required station can then be selected using either the “Prev” /”Next” or the “Up”, “Down”, “Select” buttons as described later in this manual.

If the radio has been moved, or should additional stations need to be added to the station list, the “Autotune” function can be used at any time. **Tip:** If taking the unit outside try another Autotune once clear of buildings, this may add further receivable stations to the station list.

**Important Note:** During the scan process you may find the unit indicates it has found more stations than the number that appear in the station list , the additional stations that are picked up could be either

- a. Secondary stations that are accessed via the secondary button (see later notes) or
- b. Data services provided on DAB which cannot be used on this unit

## DAB operation (contd.)

### Station List

The Station List is the heart of the DAB Tuning system and is the key fundamental difference between digital and analogue radio. An example of a fictional Station List is provided at the beginning of the DAB Operation section of this manual.

A Station List can only be created using the Autotune function



**No DAB Service  
Check Aerial....**

**Note:** If for some reason no DAB stations can be received, then this message will be displayed. In such a case the receiver will allow the use of the “Display” button to select the “Signal” option on line 2 of the display.

This can then be used to optimise the aerial position for best signal strength. When this has been done perform “Autotune” as normal. After 15-20 seconds, the radio will have checked for all available DAB stations, and will have created a new Station List. If the same message reappears then please refer to the General Operation section of this manual.

### Special Functions of Digital Radio and Station Lists

All broadcasters are permitted to change the content of their digital radio transmissions at any time by adding and removing stations.

Many broadcasters take advantage of this facility for catering for special audiences. An example of this would be adding a special station for children during the day and then replacing it with a more adult oriented station programming at night.

With DAB stations it is also possible to split an existing station into two or more separate stations for a period. This is often done on “speech only” stations where the broadcaster may wish to deliver coverage of different sporting events at the same time. The new stations are “underneath” the existing (primary) stations and the new stations are known as “Secondary” stations.

These two special functions, are only available on the DAB Network, and can mean that the content of the Station List changes over time.

Information about these facilities and changes are made available by the following means.

#### Stations that have been removed or are no longer transmitting

If a station has been removed or has stopped transmitting the Station List will display this with a small “x” at the end of the Station Name to indicate that this station did exist but has now been removed. This station will not be available for listening to. It is possible that this station will “reappear” at some time, when and if it does the small “x” will not be present adjacent to the station name and it will then be available to listen to again.

#### Secondary Stations

If the DAB station selected has been “split” and there are one or more other stations hidden underneath it, the radio will indicate this by illuminating the “Secondary” LED which is on the left-hand side above the display .

Pressing the “Secondary” button will allow the selection of the first “Secondary Station”. Pressing the “secondary” button again will select the next secondary station and so on until it returns to the original (primary) station.

**Goodmans Product Information Helpline 0870 873 0080**

## DAB operation (contd.)

### Selecting Stations to listen to in the Station List

There are two methods available for selecting a station to listen to from the Station List.

These methods are called "Direct Mode" and "Indirect Mode"

Please note that stations can be removed from transmission by the broadcaster and this will be indicated in the Station List as described in the previous section of this manual

#### Direct Mode

This mode uses the "Prev" and "Next" buttons to select the required station from the Station List.

This mode works as follows.

Using the fictional Station List at the beginning of the DAB Operation section of this manual as an example.

When listening to "C-Example Station" and the "Next" button is pressed, the receiver will immediately tune the next station in the Station List "D-Example Station".

When listening to "C-Example Station" and the "Prev" button is pressed the receiver will immediately tune to the previous station in the list "B-Example Station".

NOTE : Don't forget the Station List is cyclic so continuing the selection down past the bottom of the list will jump to the top of the list and vice versa. Pressing and holding PREV or NEXT Buttons will scroll quickly through the station list, releasing the button at the required station will cause immediate retuning to the selected station.

#### Indirect Mode

The Indirect Mode of selecting stations from the Station List uses the "Up", "Down", and "Select" buttons to choose a station to listen to,

This mode works as follows

Press the "Up" or "Down" button and the second line of the display will change to show the station above or below the one currently being listened to in the list The top line of the display will continue to show the name of the station currently being listened to and the audio from this station will continue to be heard. (pressing and holding the up or down button will scroll the list at a faster rate)

When the required station is shown on line 2 press the "Select" button to confirm selection. The name of the station will then move to line1 of the display and after a brief pause, the audio for the station will be heard.

Line 2 of the display will return to the information that was selected prior to the "Up" or "Down" button being pressed.

With the exception of the "Select" button the only other button that can be used to exit this mode is the "Power" button.

## DAB operation (contd.)

### Selecting Stations from the Station List (contd.)

#### Storing and Recalling Presets in DAB

To make the selection of the most listened to stations faster, up to 10 DAB stations can be stored into preset memories.

The preset memories are in the form of a list of Preset Locations numbered 0 to 9.

#### Storing a Station as a Preset

To store a station into a Preset location

- 1) Tune the radio to the required station.
- 2) **Press and hold** the “Preset” button for more than 3 seconds and the first preset in the list of Preset Locations will appear with “**S-00**” on line 2 of the display.

**Note** The name of the current station stored in that Preset location will be shown or “empty” will be displayed if nothing is currently stored there

- 3) Use the “Up” and “Down” buttons to select the location in which to store the station. The preset list is cyclic therefore scrolling down past location 9 will jump to location 0 and scrolling up past location 0 will jump to location 9.
- 4) Press the “Select” button to store the station into the chosen preset location.
- 5) The station is now stored in that location. Note: any previous station stored in the selected location will be overwritten.
- 6) To confirm the store operation was successful, “Stored” will show in line 1 of the display” for a few seconds, then line 2 will revert to the display mode that was selected before the preset storage processed commenced.

#### Recalling a Preset Station

To recall a station from a Preset location.

- 1) **Briefly press** the “Preset” button and the first Preset Location “**P-00**” will appear on line 2 of the display.

**Note** The name of the current station stored in the selected Preset location will be shown or it will show “empty” if nothing is currently stored there

- 2) Using the “Up” and “Down” buttons to locate the required preset. This list is cyclic therefore scrolling down past location 9 will jump to location 0 and scrolling up past location 0 will jump to location 9.
- 3) Press the “Select” button to recall and tune to the selected preset.



## DAB operation (contd.)

### Timer Function

The timer function allows the radio to sound a buzzer once a preset time period has elapsed.

#### Setting the Timer



Press and hold the “Select” button for more than 2 seconds. The display will show “00:20” if the timer has not previously been set, or whatever value the timer is currently set to.



Press the “up” or “down” buttons to adjust the time between 00:01 (one minute) and 4:15 (4 hours and 15 minutes). If one of the buttons is pressed briefly, the time will increase or decrease by one minute. Pressing and holding one of the buttons causes the time to increase or decrease rapidly, release the button once the required time is reached.

Once the required time is reached, press the “Select” button. The display will revert to the normal radio display, and an animated “hourglass” icon will show in the bottom right hand corner of the display.

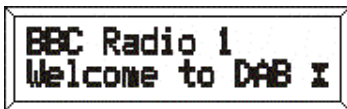

This will show until the preset time is reached and the buzzer sounds

#### Reviewing the Remaining time

To view the remaining time prior to the buzzer sounding, press and hold the “Select” button for more than 2 seconds.

The remaining time will be shown in the display.

Briefly press the “Select” button again to revert to the previous display.

#### Cancelling the Timer

To cancel the timer before the buzzer sounds press the “Select” button for more than 2 seconds the current timer value will appear. Using the “Down” button set the displayed value to “00.00” and press “Select”. This will cancel the timer and remove the hourglass symbol from the display.

#### Stopping the Buzzer

Press the “Select” button briefly to cancel the timer (once it has activated) and stop the buzzer from sounding. If the buzzer is not cancelled it will stop automatically after about five minutes.

**Note:** The Timer function can only be set when the unit is switched on, but will continue to operate when the unit is put into standby mode (the hourglass symbol will disappear from the display in standby mode). If the Radio is being listened to when the buzzer sounds the radio will not be muted but the buzzer will be superimposed over the radio output, this is normal.

## DAB operation (contd.)

### Menu Function

The menu function allows the configuration of some functions of the radio.

The menu options available are:

- Favourites
- Clock 12/24
- Factory Defaults

### Accessing the Menu

To access the menu, press the “Menu” button while listening to any DAB radio station.

**Note:** If no action is taken within a few seconds of pressing the menu button the unit will revert to the normal display.

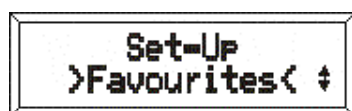

The display will show this message.

The >< arrow icons indicate that other menu items are available  
This list is cyclic.

Use the “Up” and “Down” buttons to select the required menu option

When the required option is shown on line 2 of the display press “Select” to enter the feature.

Pressing the “Menu” button at any time will revert to the previous menu item or display.

If the unit is at the top-level menu, pressing the “Menu” button will exit the menu mode and return the unit to normal radio mode.

The radio will only respond to “Up”, “Down”, “Select”, “Menu” or “Power” buttons whilst in the “menu” mode.

### Sort station list by Favourites

Selecting this function will move the Favourite Stations to the top of the current Station List in order of “most frequently listened to”.

#### What is a “Favourite Station”

A station will become a favourite in two ways, using a scoring system. The station that has the highest score becomes the “most favourite”, the station with the second highest score becomes the “second favourite” and so on up to a maximum number of five stations.

The first part of the scoring system relates to the number of times a station is tuned to. The more times it is tuned to the higher the score becomes.

The second part of the scoring system relates to the length of time a station is listened to. The longer a station is listened to the higher the score becomes.

**NOTE** All favourite station scores are set to zero when an Autotune operation is performed.

## DAB operation (contd.)

### Turning the Sort By Favourites option On and Off

Press the "Menu" button use the "Up" and "Down" buttons to move to the Favourites option  
The display will then show.



Press the "Select" button to enter the Favourites option  
The display will then show

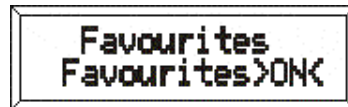

Press the "Up" or "Down" buttons to toggle the selection between ON and OFF.

Then press the "Select" button to confirm the selection the display will revert to it's previous state.

Turning this option on and off does not affect the "scores" of the stations, which are only cleared by performing an Autotune.

The Factory Default is Favourites turned OFF.

### Clock Option

In DAB Mode, the clock is set automatically, and will be automatically updated for daylight saving.

The broadcaster of the DAB station being listened to transmits the updated clock information, it is therefore always accurate and no manual setting of the clock is not possible nor is it required.

When the radio is switched off, the time is kept updated by the radio's own internal clock.

If no power source is available to the unit, either AC supply, or batteries then the time setting will be lost. It will however be recovered as soon as the radio is powered on and tuned to a DAB Station.

There are two display modes for clock display

#### 12/24 hour mode

This feature allows either 12-hour mode (e.g. 02:45PM) or 24-hour mode (e.g. 14:45). The default setting is "24-hour mode".

#### Switching between 12 and 24 hour clock mode

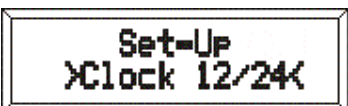

Press the "Menu" button and use the "Up" and "Down" buttons to move to the Clock option in the menu. Press the "Select" button

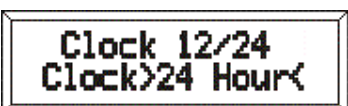

Pressing the "Up" and "Down" buttons will then toggle the selection between "12 Hour" and "24 Hour". Press the "Select" button to confirm the required mode, the display will revert to it's previous state

**Goodmans Product Information Helpline 0870 873 0080**

## DAB operation (contd.)

### Factory Defaults

This feature allows the unit to be reset to the state it was when it was first manufactured. It clears all memories, including all presets and the Station List.

### Selecting Factory Defaults

A rectangular LCD screen with a black border. The text is displayed in a monospaced font. The top line reads "Set-Up" and the bottom line reads "&gt;Set Defaults&lt;".

Press the "Menu" button and then use the "Up" and "Down" buttons to move to the Set Defaults function. Press the "Select" button to enter the Set Default function.

A rectangular LCD screen with a black border. The text is displayed in a monospaced font. The top line reads "Reset To Factory" and the bottom line reads "Are You Sure??".

To proceed with set defaults, press the "Select" button briefly.

A rectangular LCD screen with a black border. The text is displayed in a monospaced font. The top line reads "Factory Defaults" and the bottom line reads "Memories Reset".

This message confirms that all presets are being cleared, and all "service" lists are being erased.

*AFTER ABOUT 10 SECONDS* an Autotune operation will then start automatically.

## Troubleshooting guide

Every effort has been made to ensure this product provides optimum performance in all conditions ,however we appreciate that sometimes difficulties may arise and the following table summarises some common problems.

Problem	Possible cause	Remedy
<b>General</b> No Sound	No power to unit	<ul style="list-style-type: none"> <li>▪ Check AC supply is connected and switched on</li> <li>▪ If batteries are being used check they are not exhausted</li> <li>▪ Check the unit is switched on</li> </ul>
	Volume control at Minimum	<ul style="list-style-type: none"> <li>▪ Rotate volume control clockwise</li> </ul>
	Headphones connected to headphone socket	<ul style="list-style-type: none"> <li>▪ Remove headphones</li> </ul>
No DAB stations found	Aerial not extended	<ul style="list-style-type: none"> <li>▪ Check Aerial and unit position</li> <li>▪ Use the signal meter on the unit to check for signal</li> </ul>
	Outside broadcast area	<ul style="list-style-type: none"> <li>▪ Check location reception details at <a href="http://www.drdb.org">www.drdb.org</a> or call 08707 74 74 74</li> </ul>
Erroneous information in the display	Temporary memory problem	<ul style="list-style-type: none"> <li>▪ Switch the unit off then back ON this will clear the problem</li> </ul>

If the problem experienced is not listed above or if after checking the remedies the problem still exists , please call our product information helpline on

**0870 873 0080**

For further assistance

**Goodmans Product Information Helpline 0870 873 0080**

## Specifications

AC Supply Voltage: 230VAC, 50Hz

DC Supply Voltage: 6V via 4 x LR20 "D" size batteries (Not Supplied)

Battery Life: up to 20 hours ON with 4 long life alkaline batteries upto 4 Months in standby mode

Receiver Bands: DAB Band III: 174.928 MHz (5A) – 239.200MHz (13F)

DAB Modes I, II, III and IV

Tuning Range - 11B to 12D

DAB sensitivity: -98dBm or better

DAB Adjacent Channel Rejection: -30dB or better

DAB audio decode: 64kbps - 384kbps

Aerials: Built-in telescopic rod aerial for DAB reception

Power Output (at 10% THD): 2 x 0.5W RMS

Headphones Socket: 3.5mm diameter, 32Ω

Speakers: 2 x 3"

Audio Line Output: via 2 x RCA sockets

*Specifications are subject to change and improvement at any time without notice.*

## Free Manuals Download Website

<http://myh66.com>

<http://usermanuals.us>

<http://www.somanuals.com>

<http://www.4manuals.cc>

<http://www.manual-lib.com>

<http://www.404manual.com>

<http://www.luxmanual.com>

<http://aubethermostatmanual.com>

Golf course search by state

<http://golfingnear.com>

Email search by domain

<http://emailbydomain.com>

Auto manuals search

<http://auto.somanuals.com>

TV manuals search

<http://tv.somanuals.com>