

Goodmans

Model. GDR10

Crystal
Mark
16539

Clarity approved by
Plain English Campaign

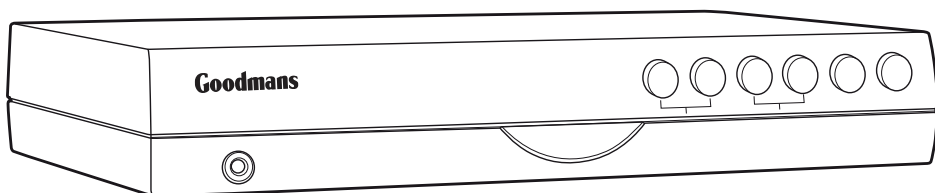
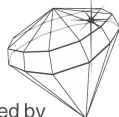

User guide for Digital TV receiver

Contents

What's in the box?	3
How to connect the receiver to your digital hi-fi sound system	16
How to connect headphones to the receiver	17
What the on-screen symbols mean	18
How to turn the receiver on for the first time	20
How to turn the receiver off	24
Important information about over-air downloads	25
How to turn the receiver back on from standby	26
How to tune in TV and radio stations.....	26
Important information about searching for new channels	27
The menu screens.....	40
Safety information	69
Help and advice.....	73
Product specification.....	75

What's in the box?

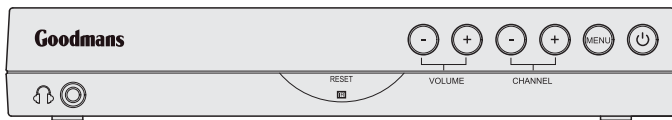

Receiver



Remote control

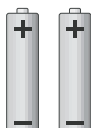

Two batteries



RF cable

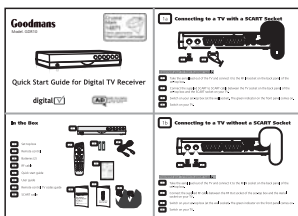

Quick-start guide

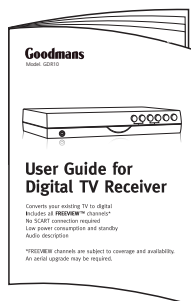

User guide

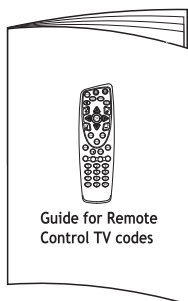

Guide to remote-control TV codes

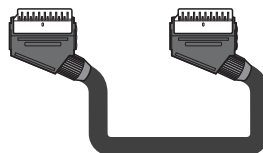

SCART cable

Receiver

Front panel

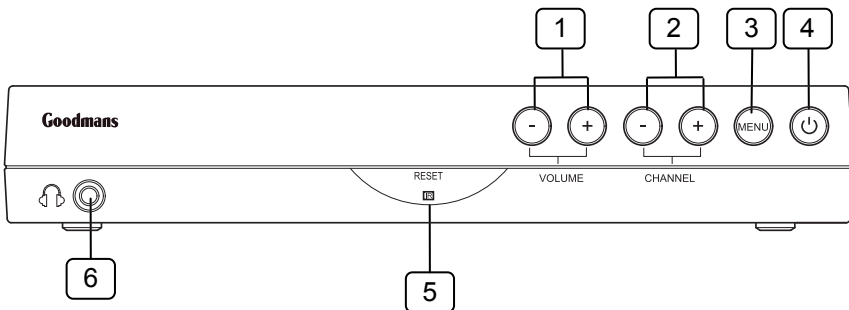

- 1 Volume buttons
- 2 Channel buttons (these buttons go up and down the list and go through the on-screen menus)
- 3 Menu button
- 4 Standby and on and off light (switches the receiver on and off or, if it is pressed quickly, it can be used as the OK button)
- 5 Reset button (this switches the receiver off and on again when it isn't working properly)
- 6 Headphone socket (3.5 millimetres)



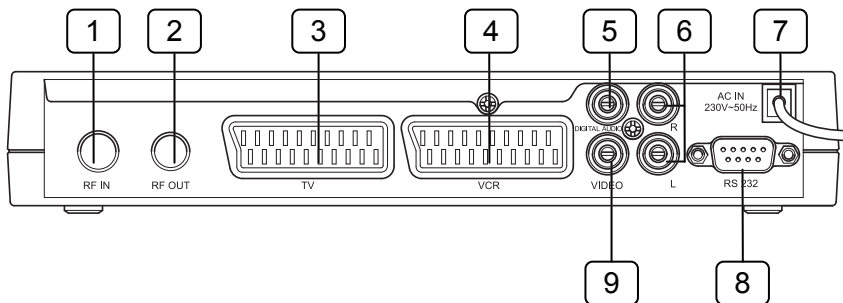





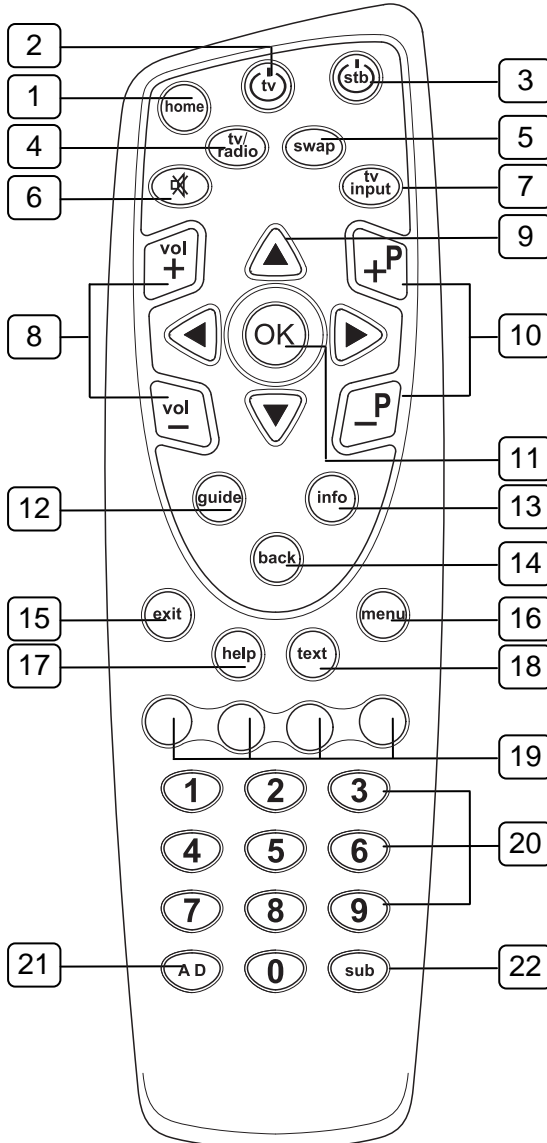



Back panel

















- 1 'RF IN' socket (to your TV aerial)
- 2 'RF OUT' socket (to your TV or VCR)
- 3 SCART out socket (to your TV)
- 4 SCART out socket (to your VCR)
- 5 Digital-audio out socket
- 6 Audio out socket
- 7 Mains cable
- 8 Socket for factory use only
- 9 Video out socket

Remote control buttons



<i>Number on diagram</i>	<i>Button name</i>	<i>What the button does</i>
1	<home> 	Goes to the first channel in your list (usually BBC 1)
2		Switches your TV on or off (if you have set up this feature)
3		Switches the receiver on and off (onto standby)
4		Switches between TV and radio
5		Switches between the channel you're watching and the channel you were previously watching
6		Mutes the receiver volume (it can also mute your TV if you have set up this feature)
7		Selects the channel the receiver is set up on (if you have set up this feature)
8	 	Increases or reduces the receiver volume. These buttons can also increase or reduce your TV volume (if you have set up this feature)
9	   	Moves around the on-screen menus

Number on diagram	Button name	What the button does
10	 	Goes up and down the channel list
11		Selects options on the on-screen menu (This button also shows the channel list if you press it while watching TV.)
12		Enters and exits the TV electronic programme guide (EPG)
13		Gives programme information on the TV screen This button also shows your favourite channels list when you are on the channel list screen.
14		Goes back to the previous screen you were on
15		Exits the menu system and goes back to the last programme you were watching
16		Enters and exits the menu screen
17		Enters and exits the help screen
18		Gives digital teletext
19	Red, yellow, green and blue buttons	Changes or goes to different options when you are on the digital text pages
20	 to 	Chooses channel numbers and numbers on menus that go to different options
21		Switches the audio description on and off
22		Switches subtitles on and off

Putting batteries in the remote control

- 1 Remove the battery cover from the remote control.
- 2 Look at the polarity diagram (the '+' and '-' symbols) printed on inside of the battery case. (This diagram tells you which way round to put the batteries in the remote control.)
- 3 Put two AA batteries in the battery as shown in the diagram and in line with the markings on the batteries ('+' goes next to '+', '-' goes next to '-').
- 4 Replace the cover.

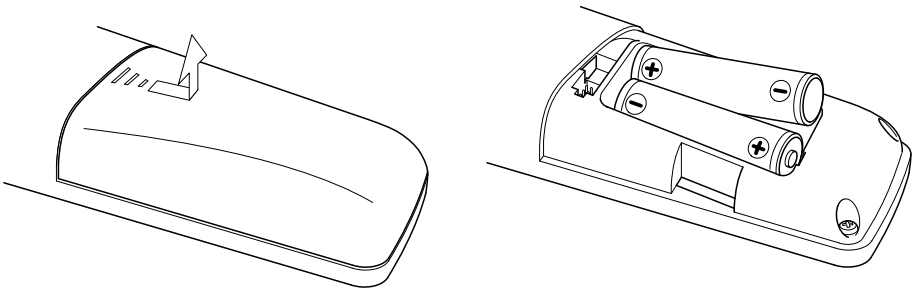

Using the remote control

The remote control 'talks' to the receiver using an infrared link between the sensor on the remote control and the sensor on the front of the receiver. (Infrared light is an invisible beam of light that is often found on objects that 'talk to' other objects, such as TV remotes and TVs.)

You can use the remote control up to six metres away from the receiver, and at an angle of 30 degrees to the receiver's front panel (see below). The remote control will **not** work if there is something between the remote control and the receiver. If you use your remote control in direct sunlight or very bright light, it may mean the remote control does **not** work as well as usual.

How to use the remote control

- 1 Point the sensor end of the remote control towards the sensor in the centre of the receiver's front panel.
- 2 Press the button you want to use, for example the standby button, or the guide button.

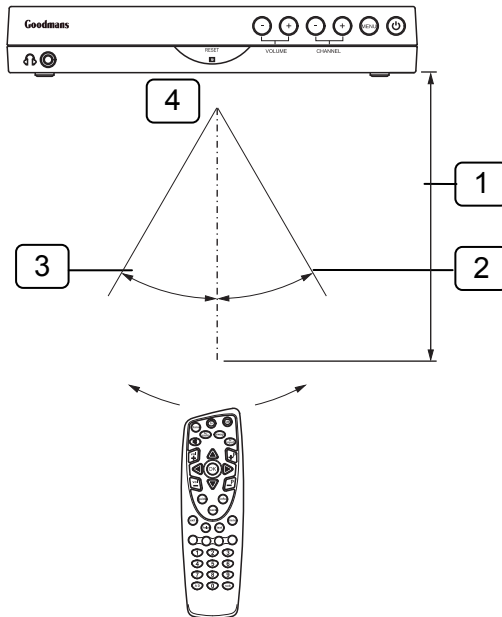

- 1 Within about six metres (20 feet)
- 2 30°
- 3 30°
- 4 Remote sensor

How to connect the receiver to your TV

- 1 Put your receiver on a firm, level surface with at least a 10-centimetre gap around all the sides. Make sure it is close to the TV you are going to connect it to.
- 2 Turn off the plug socket your TV is plugged into or pull the TV's plug out of the socket.
- 3 Take the aerial lead out of the TV and connect it to the 'RF IN' socket on the back panel of the receiver.
- 4 There are three ways to connect your receiver to your TV. (See pages 13, 14 and 15.)
- 5 Once you have connected the receiver, plug the receiver's power lead into the mains.
- 6 Plug the TV back into the mains socket.

Connection 1 (If your TV has a SCART socket)

- 1 Plug the SCART cable (which came with the receiver) into the SCART 'out' socket (you will find the socket on the back panel of the receiver labelled 'TV').
- 2 Connect the other end to the SCART socket on your TV. Connecting your receiver in this way will give you a high-quality picture on your TV.
- 3 Plug your receiver into a wall socket and switch it on. A green light should come on.
- 4 Switch on your TV.

If there is more than one SCART connector on your TV, look in your TV instruction manual to check which one you should use.

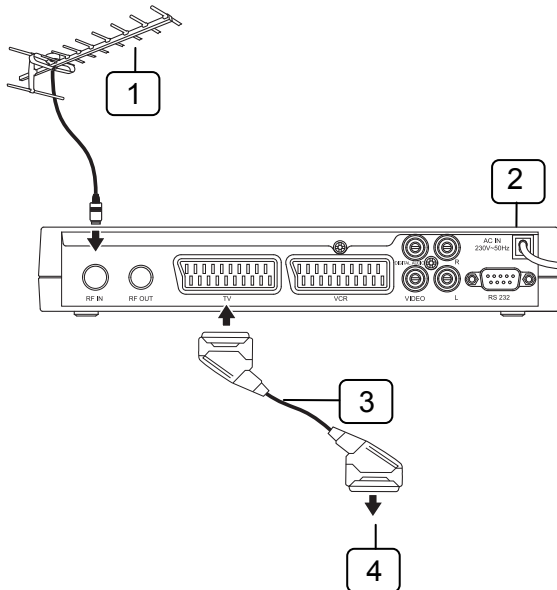

- 1 Outside aerial
- 2 Receiver
- 3 SCART cable (included with your receiver)
- 4 To your TV's SCART 'in' socket

Connection 2 (If your TV does **not** have a SCART socket)

- 1 Disconnect your TV from its power supply.
- 2 Take the aerial lead out of the TV and connect it to the 'RF IN' socket on the receiver's back panel.
- 3 Connect the RF cable (that was supplied with the receiver) between the 'RF OUT' socket on the receiver and the aerial socket on the TV.
- 4 Plug your receiver in a wall socket and switch it on. A green light should come on.
- 5 Switch on your TV.

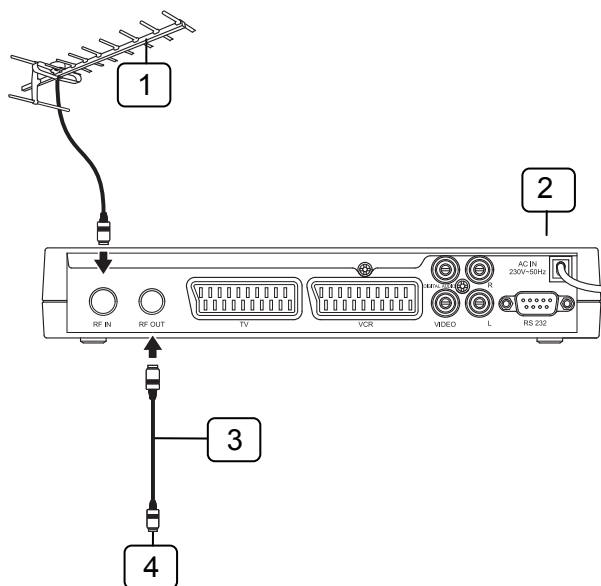

- 1 Outside aerial
- 2 Receiver
- 3 RF cable (that was supplied with the receiver)
- 4 To your TV's aerial socket

Connection 3 (If you want to connect using an AV cable)

Plug an AV cable (this is **not** supplied with your receiver, but you can get one from an electrical shop) into the 'L', 'R' and 'VIDEO' sockets (on the back panel of the receiver) and connect it to the 'AV line in' sockets on your TV.

To see the picture on your TV you will need to choose the 'AV' channel on your TV. If you have difficulty doing this, please read the TV's instruction manual.

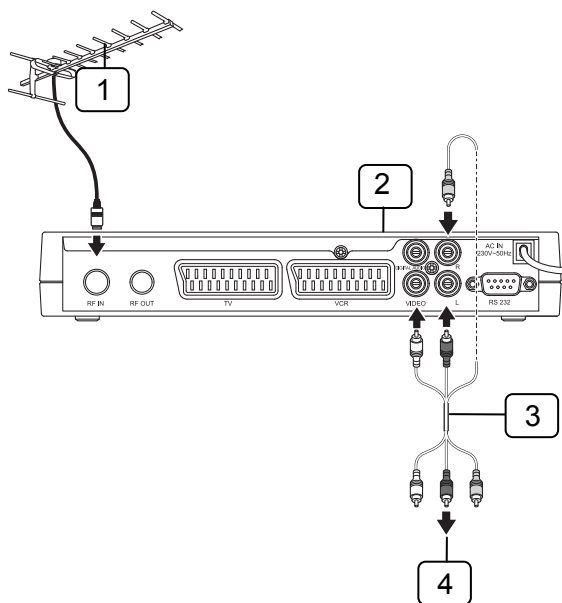

- 1 Outside aerial
- 2 Receiver
- 3 AV cable (this is not supplied with your receiver)
- 4 To the TV's 'AV in' sockets

How to connect the receiver to your digital hi-fi sound system

- 1 Connect a coaxial cable to the 'digital audio' socket in the back of the receiver.
- 2 Connect to the digital audio socket on your hi-fi system.

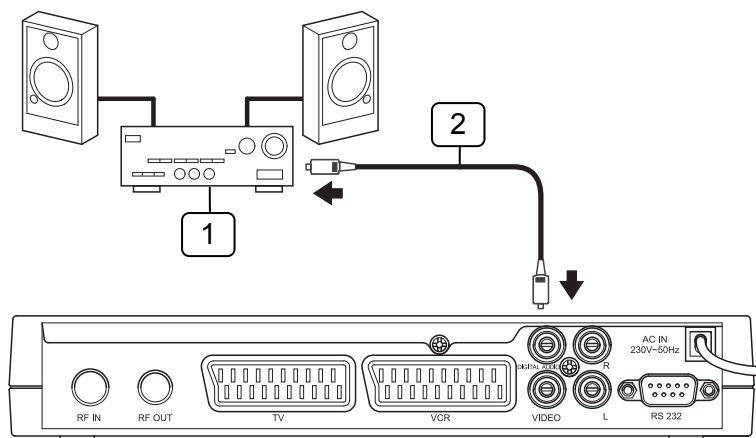

- 1 Hi-fi
- 2 Coaxial cable (this is **not** included with your receiver, but you can get one from an electrical shop)

How to connect headphones to the receiver

- 1 Connect a 3.5 millimetre plug (this is usually the same width as a normal headphones plug) from your headphones to the headphone socket on the front panel of the receiver.

You can change the volume on the receiver using the remote control (see page 6) or the in-line volume control on your headphones (see the diagram below).

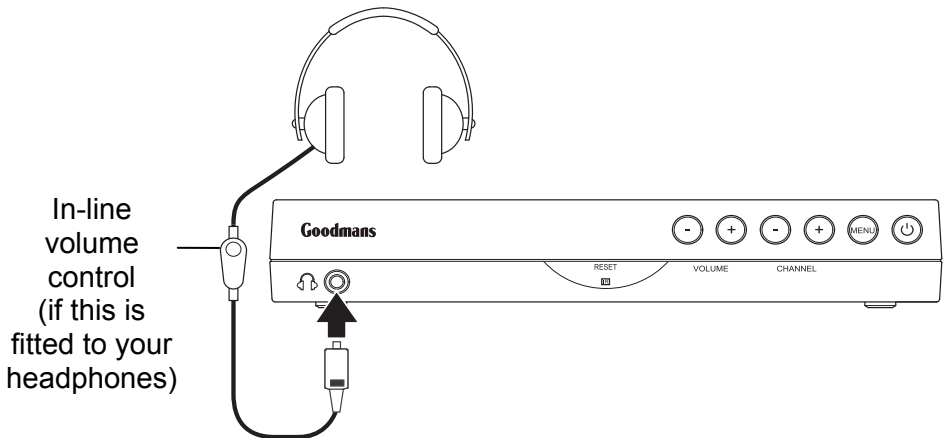

What the on-screen symbols mean

You may see these symbols on your screen. These symbols usually show which remote control buttons can be used on, or apply to, that screen. For example, if the programme you are watching has subtitles available, when you select a TV channel or press the information screen the  symbol will be shown.

Subtitles available



This symbol is shown when subtitles are available on the TV channel you are watching.

Subtitles is a service for people with hearing problems. Text is shown on-screen that repeats any spoken word or describes any sounds as the programme runs (see page 34).

Subtitles on

This symbol is also shown for a short time at the top of your screen if you switch subtitles on.

Subtitles off



This symbol is shown for a short time at the top of your screen if you switch subtitles off.

Audio description available



This symbol is shown when Audio description (AD) is available on the TV channel you have selected.

Audio description is a voice-over service which describes what is happening on a programme. This service is meant for people with sight problems (see page 35).

Audio
description on

This symbol is also shown for a short time at the top of your screen if you switch AD on.

Audio
description off

This symbol is shown for a short time at the top of your screen if you switch AD off.

Reminder



This symbol is shown if you have set a reminder for a programme that is to start in the next few minutes (see page 37).

Information
pages



This gives you information about the programme you're watching or other programmes that are going to be shown in the future.

Signal strength



This symbol shows the signal strength. A transmitter sends out a signal to your receiver. Depending on which area you are in, you may have a strong or weak signal.

Parental lock



This symbol is shown when the channel you have selected has been locked (see page 42).

How to turn the receiver on for the first time

When you have connected your receiver to the TV, it is then ready to use.

- 1 Switch on the TV.
- 2 Set the TV to the input channel you have connected the receiver to (AV1, for example).
- 3 Switch on the receiver at the mains.
- 4 The standby light will turn green, which shows that the receiver is ready to use.
- 5 Your TV will show the 'welcome' screen (as shown below).

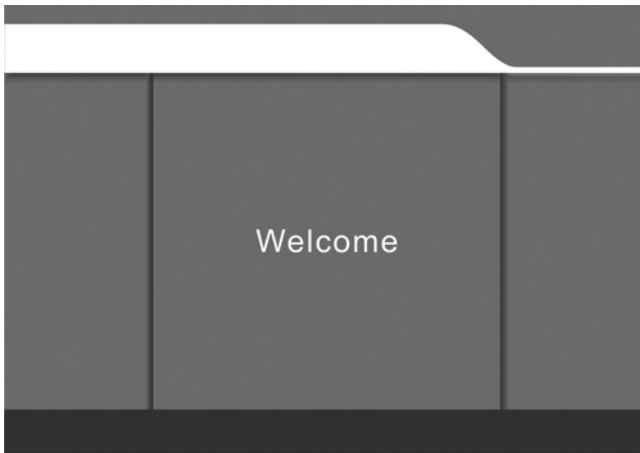

- 6 After a few seconds, the screen will change to the TV format screen.



- 7 Make sure that you have connected your TV aerial to your TV.
- 8 Select the format you want (either '16:9' or '4:3'), using the left and right arrow buttons on the remote control.
- 9 If you select the '4:3' format, you will see the screen on the following page which lets you select an aspect ratio for your TV. (The aspect ratio defines the width and height of your TV screen.)



- 10 The aspect ratio options are 'letterbox', 'compromise' and 'cut out'. Use the arrow buttons on your remote control to choose the one that best matches your TV.
- 11 When you have made your selection, press 'OK' on your remote control.
- 12 Your receiver will now start to tune in to your new digital TV and radio channels. You will see the screen on the following page when your receiver is tuning in.



- 13 When all the available TV and radio channels have been tuned in, an 'installation completed' message will appear on the screen.
- 14 You will now be able to watch TV.
- 15 If the receiver does **not** find any channels, read the help and advice page on page 73.

How to turn the receiver off

If you usually watch television every day, you should leave the receiver on standby when you're **not** watching it. **You** should only switch it off at the mains if you are away or you do **not** want to use the receiver for a long time (a month, for example).

Your receiver will automatically search for new channels when you switch to standby (see the section on over-air downloads on page 25).

Your receiver can only search for and download updates when it is on standby.

You can put the receiver on 'standby' as follows.

- 1 Press the remote control button labelled 'stb'.
- 2 Check that the receiver's standby light turns red. This turns off the output from the receiver, and the TV picture will then turn off. You will then need to switch off your TV too if you want to stop watching it.

Do **not** unplug the receiver from the mains until the standby light (also the 'on' and 'off' light) stops flashing. Please see 'Important information' on page 25.

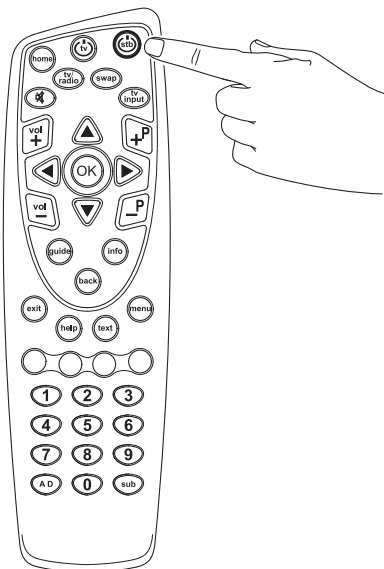

Important information about over-air downloads

Whenever you put the receiver on standby (this means you switch the receiver off with the remote), the receiver will search for any available over-air downloads (OADs). These are updates for the receiver.

When the receiver is searching for or downloading an OAD, the standby light (also the on and off light) indicator will flash. While it is flashing, you must **not** unplug the receiver from the plug socket.

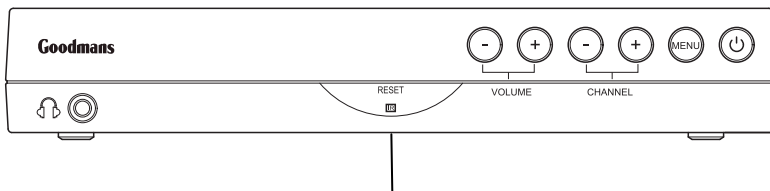

Standby ON/OFF indicator

When an OAD has finished, a message will appear on your screen telling you this. If your TV is switched off, you will see this message next time you turn your TV on.

How to turn the receiver back on from standby

- 1 Switch on your TV.
- 2 Press the receiver remote control button labelled 'stb'.
- 3 The receiver standby light will turn green and the TV picture will come on.

How to tune in TV and radio stations

If this is the first time you have switched on the receiver, see the first time installation section on page 20.

If this is **not** the first time you have switched the receiver on, it will turn on and tune into the last channel you were watching before you last switched it off.

If the receiver doesn't find any channels, please read the help and advice section on page 73.

Important information about searching for new channels

The receiver gives you two ways to search for new TV and radio channels.

1 Automatic channel search when the receiver is on standby

- As new channels and features become available, your receiver will automatically search for them. **This will only happen when you put the receiver on standby.** You will then see the standby light flash slowly to show that it is searching for new channels.
- When it has finished searching, the light will stop flashing and the receiver stays on standby as normal. **If you do not put the receiver on standby after you've watched it, you will not be able to see any new channels that might become available.**
- When you switch the receiver on again, and an automatic search has been done while it was on standby, you will see a message saying 'The list of channels has been changed'. You can start watching TV by pressing the 'OK' button on your remote control.

2 Automatic channel search from the receiver's menu

- You can also search for new channels through the receiver's menu. To do this, see the instructions on page 53.

The channel select display



The banner in the lower part of the screen shows:

- 1 the channel number;
- 2 the channel name;
- 3 the current time; and
- 4 the information on the programme you're watching.





The programme information tells you:

- the programme name.
 - the time the programme begins and ends; and
 - if audio description or subtitles is available for that programme. For more information on the symbols, see page 18.
- 5 The yellow bar shows roughly how long the programme has been running.

You can also see the signal strength and the signal quality on the right-hand side of the screen.

How to choose a TV channel using your remote control

There are several ways that you can choose a TV channel.

- 1 Press numbers 0 to 9 (You can choose up to three digits, for example, 111 or 999. If the channel number you enter is **not** available, your TV will **not** change channel.)
- 2 Press 'P+' or 'P-'.
- 3 Press 'OK'. (This will show the channel list. You can use the  and  buttons to choose another channel. For more information, see page 30.)
- 4 Press 'guide'. (This will show the channel guide. You can use the  and  buttons to choose another channel. For more information, see page 37.)





The way you can choose channels depends on other settings, such as if you have set your favourite channels or locked certain channels (see page 44 for more information).

How to use the channel list

The channel list displays all your available channels.



The channel list display

<i>What do you want to do?</i>	<i>You need to press this button</i>
Go to the channel list while you are watching TV	Press 'OK'
Select the channel you want	Press  or  while on the channel list
View a channel	Press 'OK' while on the channel list
Display the previous six channels in the list	Press  while on the channel list
Display the next six channels in the list	Press  while on the channel list
Go back to the previous screen	Press 'back' while on the channel list
Leave the menu and go back to the last programme you were watching	Press 'exit'
Go back to the main menu	Press 'menu'

How to choose your favourite channels



You can create lists of your favourite channels, from the 'Favourite lists' menu (see page 41). You can then choose any list you want (including the channel list) using the remote control.

<i>What do you want to do?</i>	<i>You need to press this button</i>
Select the channel list while you are watching TV	Press 'OK'
Select FAV1	Press 'info' then 'OK'
Select FAV2	Press 'info' then 'OK'
Select the channel list...	Press 'info' then 'OK'
Go back to the previous screen	Press 'back'
Exit the menu and go back to the last programme you were watching	Press 'exit'
Return to the main menu...	Press 'menu'

How to swap between channels

There is a  button on the remote control that lets you swap between the TV channel that you are watching and the TV channel that you were previously watching.

How to change the volume

<i>What do you want to do?</i>	<i>Press this button</i>
Turn the volume up	Press 'vol +'
Turn the volume down	Press 'vol -'
Turn the volume off	Press []
Turn the volume on	Press []

How to select TV or radio

What do you want to do?	Press this button
Select the radio (when you are watching TV)	Press 'tv/radio'
Select the TV (when you are listening to the radio)	Press 'tv/radio'

The on-screen help pages

The help pages give advice on and help with many of the features of the receiver. Press the 'help' button to read more information about audio description (AD), how to swap channels and TV input (TV input is how you can programme your remote control to use your TV).

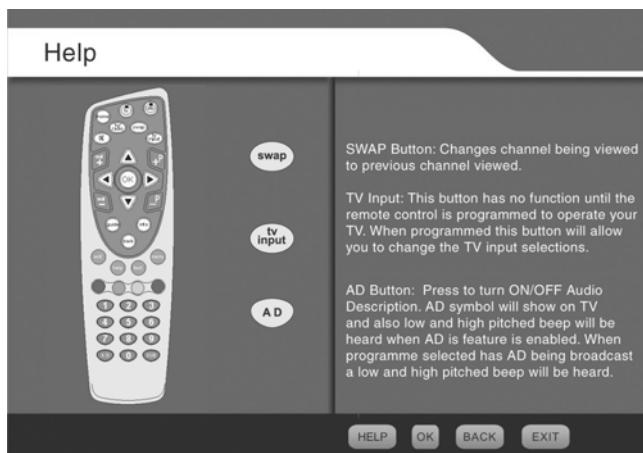

The 'home' help pages display

To go back to the main display, press any of the four remote control buttons shown at the bottom of the help screen (either 'help', 'ok', 'back' or 'exit').

The information screen

The information screen gives a summary of the programme you're currently watching and future programmes.



The information screen

For a list of on-screen symbols, see page 18.

Subtitles

Subtitles give you an on-screen text version of the conversation or narrative on the TV channel you're watching.

When you choose subtitles, your TV will show the subtitles for the channel you are watching at the bottom of the screen over the picture.

<i>What do you want to do?</i>	<i>Press this button.</i>
Turn on subtitles	Press 'sub'
Turn off subtitles	Press 'sub'

If you change channel, subtitles will appear on the new channel until you turn the subtitles off.

Not all programmes have subtitles. In this case, the TV will show 'Subtitles off' when you try to choose subtitles.

You cannot use subtitles at the same time as digital teletext.

How to use audio description

Audio description is a spoken narration that describes all important information on a programme, such as body language, facial expressions, scenery, action, costumes or anything that helps to express the plot of the story, event or image.

Audio description is **not** always available but you can check, in the following way, when it will be available.







The availability of audio description is shown by a beep, which can be heard in three different pitches. These are high, medium and low. A high-pitched tone means that audio description is on and available. A medium-pitched tone means audio description is on but **not** available. A low-pitched tone means audio description is **not** available at all on that programme or channel.

You can also see if audio description (AD) is available if the  symbol is shown on the information display. For more information on what the symbols mean, see page 18.

<i>What do you want to do?</i>	<i>Press this button</i>
Switch on audio description (AD)	Press 'AD'. (You will hear a high-pitched beep if AD is available for your current programme and a medium-pitched beep if it is not .)
Switch off audio description	Press 'AD'. (You will hear a low-pitched beep.)
If you want to check if AD is available for your next programme	Press 'info'. (You will hear a high-pitched beep when AD is available.) You can also press 'guide'. If you can see the 'AD' logo on the programme information for the programme you want to watch, it is available.

How to use teletext

Many digital TV channels provide teletext. Teletext is pages of Information about programmes and other topics like the weather, news, holidays and shopping.

<i>What do you want to do?</i>	<i>Press this button</i>
Go to the teletext main menu	Press 'text'
Select the topic you want (such as 'holidays' or 'weather')	Press  or 
Confirm the topic you want	Press 'OK' after selecting the topic you want or press numbers 0 to 9 (as shown on the teletext channel list, for example '1' could be 'weather')
Move around the topic pages	Press  ,  ,  or 
Go to the teletext shortcuts menu	Press the green button
Go to the main teletext index menu	Press the blue button
Go back to previous teletext screen	Press the yellow button
Go back to the teletext main menu	Press the red button
Turn off teletext	Press 'text' or 'exit'

How to use the TV programme guide

The TV guide shows programme information for the next eight days.







The TV guide (programme schedule)



The TV guide (individual programme information)

The TV guide gives the following information.

- The panel at the top of the screen shows the current channel number and name.
- The panel on the right shows a short description of the programme you're currently watching.
- The left-hand side of the screen shows the programme schedule (the TV programmes that will be broadcast for the rest of the day on the date shown at the top of the panel).
- A banner at the bottom of the screen has symbols that help you to:
 - select another channel or TV programme; and
 - look at the information for TV programmes for another time.

<i>What do you want to do?</i>	<i>Press this button</i>
Go to the TV guide	Press 'guide'
Change the channel	Press 'P+' or 'P-'
Move up or down the programme schedule	Press  or  (Your TV will show the programme schedule, with a description of the programme you've chosen.)
See the programme schedule for the day before or the next day	Press  or 
Set a reminder	Press 'OK'. (If the reminder event has already passed or is starting very soon, a banner will tell you this and the reminder will not be set.)
Look at information for the programme you want to watch	Press 'info' (Your TV will show the individual programme information screen, with a full description of the programme selected.)
Exit the TV guide	Press 'exit'

If you set a reminder, you will see a reminder symbol next to the programme you've chosen in the programme schedule.

When you set a reminder and your programme is due to start, your TV will automatically change channels to the programme you've set a reminder for.

The menu screens

The menus let you select and change many of your receiver's features.

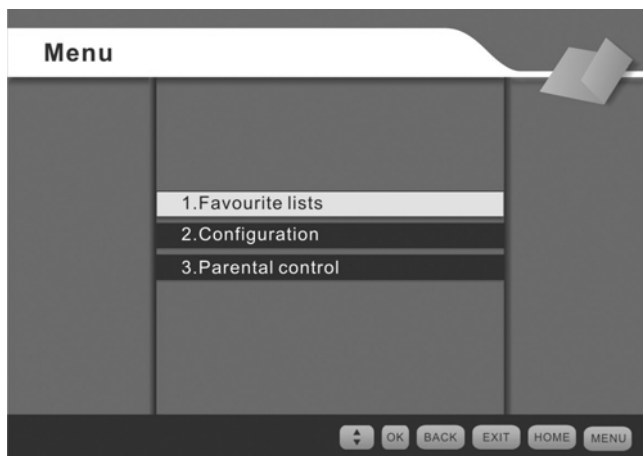

The main menu

This is the menu that appears when you select the 'menu' button on the remote control or the receiver.



Main-menu screen

The table below gives you information on how to move around the menus.

<i>What do you want to do?</i>	<i>Press this button</i>
Go to one of the menu options (for example the configuration menu)	Arrow  or  (or you can press the channel number button if it applies)
Go to the main menu	Press 'menu'
Confirm a menu option	Press 'OK' once you're on the menu screen

<i>What do you want to do?</i>	<i>Press this button</i>
Select a menu setting	Press ◀ or ▶ once you're on the menu screen
Go back to the previous screen	Press 'back'
Exit the menu system to go back to the last programme	Press 'exit' when you're on the menu screen

The favourite lists menu

This menu lets you create, change and delete your own favourite channel lists.



Favourite lists screen

How to create a favourite list

This menu lets you create your own (favourite) channel list.

- 1 Select the 'Create a favourite list' option from the favourite list menu (see page 41) by pressing the 'OK' button.
- 2 You will see a new screen (1).

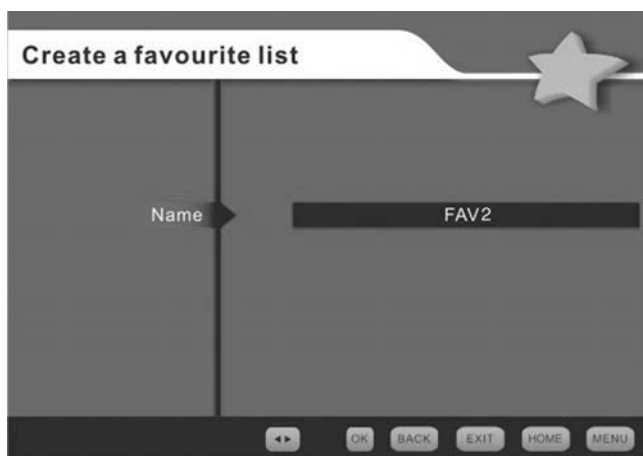

Create a favourite list screen (1)

You have a choice of two titles for your favourite channels list, either 'FAV1' or 'FAV2'. You cannot change the names of these lists.

You can now compose a list of your favourite channels from the either TV or radio channels in your channel list.

- 3 Press the 'OK' button and you will see the screen below.

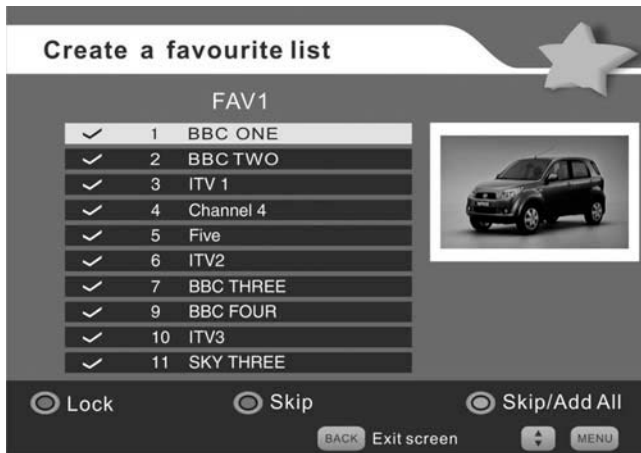

Create a favourite list' screen (2)

The tick symbol on the left-hand side of the channel description means that the channel is selected to be in your favourite channels list. When you first set up your favourite channels, all your available channels will be ticked automatically.





You can create your favourite list in two ways.

- 1 You can create a favourite list by removing each channel from the screen 2 list that you do **not** want. Do this by pressing the green button on your remote after selecting the channel you don't want. This method is best when you want most of the available channels in your list but just want to remove a small number of channels.



Create a favourite list' screen (3)

<i>What do you want to do?</i>	<i>Press this button</i>
Delete a channel from your favourite channels list	Press the green button while selecting the channel you don't want. (The tick symbol will disappear and the green button label changes to 'Add'. See screen (3) above.)
Lock a channel	Press the red button while selecting the channel you want to lock A warning appears when you first lock a channel in the list, telling you that parental controls need to be set up so the channel can be locked. If you have already set up parental controls, you can ignore this warning. Press 'OK' to make the warning screen disappear.

<i>What do you want to do?</i>	<i>Press this button</i>
Unlock a channel	<i>Press</i> the red <i>button</i> while selecting the channel you want to unlock Remember, you can only lock a channel if you have set up parental controls (see page 66).
Save the favourite list and return to the favourite lists menu	Press the 'back' button and press 'OK'. You will now see a 'Do you want to save changes?' prompt. Press  or  to say 'Yes', then press 'OK'.
Save the favourite list and return to the main menu	Press the 'exit' button and press 'OK' You will now see a box on the screen that says 'Do you want to save changes?' Press  or  to say 'Yes', then press 'OK'.

- 2 You can remove all channels from the screen (2) list by pressing the blue button, and then add the channels you want by pressing the green button. This method is best when you only want a few channels on your favourite list.



Create a favourite list screen (4)

<i>What do you want to do?</i>	<i>Press this button</i>
Remove all channels from the list	Press the blue button (The red-button label then changes to 'Skip all'. See screen (4) above.)
Confirm that you want all channels removed	Press the red button (The tick symbol appears and the green-button label changes to 'Skip'.)
Add a channel	Press the green button while selecting the channel you want

<i>What do you want to do?</i>	<i>Press this button</i>
Save the favourite list and return to the favourite lists menu	Press the 'back' button and press 'OK' You will now see a 'Do you want to save changes?' prompt. Press ◀ or ▶ to say 'Yes', then press 'OK'.
Save the favourite list and return to the main menu.	Press the 'exit' button and press 'OK' You will now see a box on the screen that says 'Do you want to save changes?' Press ◀ or ▶ to say 'Yes', then press 'OK'.

How to change your favourite channels





Changing a favourite channel list screen (1)

This menu lets you change the favourite channel lists that you have created.

For the FAV1 and FAV2 channel lists, you can choose channels to add or delete from your lists, or change their parental status (this means whether a channel is locked or unlocked).

You cannot delete any channels from the TV and radio channel list. You can only lock or unlock individual channels.

- 1 Select the 'Modify a favourite list' option from the favourite lists menu (see page 41) by pressing the 'OK' button.
- 2 You will now see screen (1) above.
- 3 Choose the list you want to change, using the  or , then press 'OK'.
- 4 If you select the FAV1 or FAV2 channel list, you will see screen 2 below.



Changing a favourite channel list screen (2)

- 5 To delete a channel, select the channel and press the green button.
- 6 To add another channel, select it and press the green button.

- 7 To lock or unlock a channel, select the channel and press the red button.
- 8 If you want to add all available channels to the list, or delete all available channels from the list, press the blue button to skip a channel or add them all.
- 9 You will now see screen (3) below.



Changing a favourite channel list screen (3)

- 10 To add all available channels to the list, press the green button.
- 11 To delete all available channels from the list, press the red button.
- 12 If you select the TV and radio channel list from the 'Modify a favourite menu', you will now see screen (4) below.



Changing the TV/radio screen (4)



- 13 To lock or unlock a channel, select the channel and press the red button.
- 14 You now need to save the changes that you have made. To do this, press the 'back' or 'exit' button.
- 15 You will now see a box on the screen that says 'Do you want to save changes?'
- 16 Press ◀ or ▶ to say 'Yes', then press 'OK'.
- 17 If you don't want to save your changes, press ◀ or ▶ to say 'No' then press 'OK'.

How to delete a favourite list

This menu lets you delete the favourite channel lists that you have created.



Delete a favourite list screen

- 1 Select the 'Delete a favourite list' option from the favourite lists menu (see page 41) by pressing the 'OK' button.
- 2 You will now see the 'Delete a favourite list' screen.
- 3 Select the list you want to delete (either FAV1 or FAV2), using the  or  buttons, and then press 'OK'.
- 4 A warning list will appear to warn you that you are going to remove a favourite list.
- 5 To confirm you want to delete the list, press 'OK'.

The configuration menu

This menu lets you select and change many of your receiver's features and settings (see page 40 to select the configuration menu).

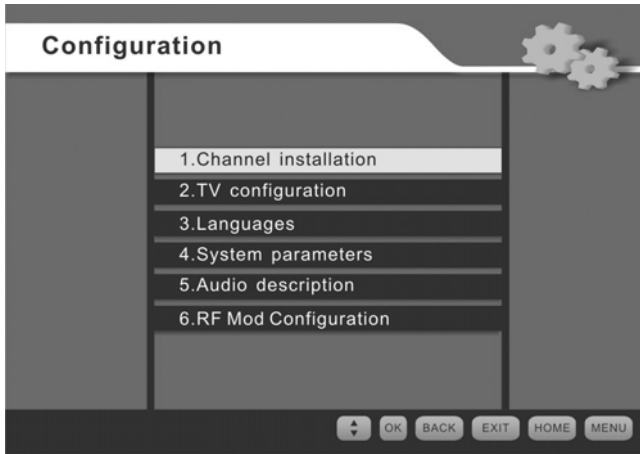

The main configuration screen

The channel installation menu

This menu has the following features.

- Automatic channel installation – this automatically scans and installs all available digital TV and radio channels.
- Signal information – the signal information screen gives information about the channel you're watching, including signal frequency, signal quality and signal level. This could affect your picture quality.



The channel installation screen

The auto channel-installation menu

This menu lets you:

- search automatically for all channels when no channels have been set up;
- search for all new channels which may become available; and
- add a channel that you want to watch.

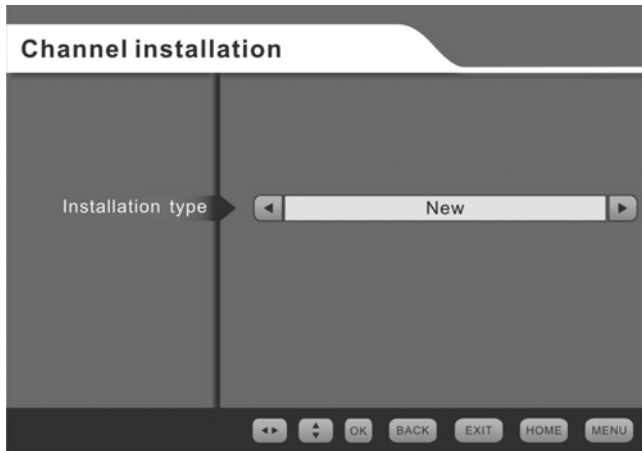

The auto channel-installation screen (1)

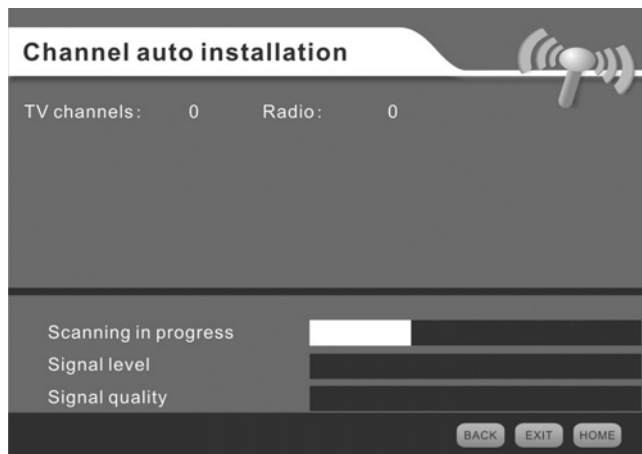

The auto channel-installation screen (2)

- 1 Select the 'channel auto-installation' option from the channel installation menu (see page 53) and press the 'OK' button.
- 2 You will now see screen (1) above.

- 3 To set your receiver to automatically install all channels, press the 'OK' button. You will now see screen (2).
- 4 To search for new channels or add a channel from screen 1 press ◀ or ▶ and you will now see screen (3) below.
- 5 To search for all new channels, press the 'OK' button.
- 6 You will now see screen (2) again.
- 7 To add a single channel, from screen (3) select 'Manual' on the installation mode option by pressing the arrow buttons and press the 'OK' button.
- 8 You will now see screen (4) (see below).
- 9 Press ◀ or ▶ to select the channel number you want to add, and press the 'OK' button. You will now see screen (2) again.

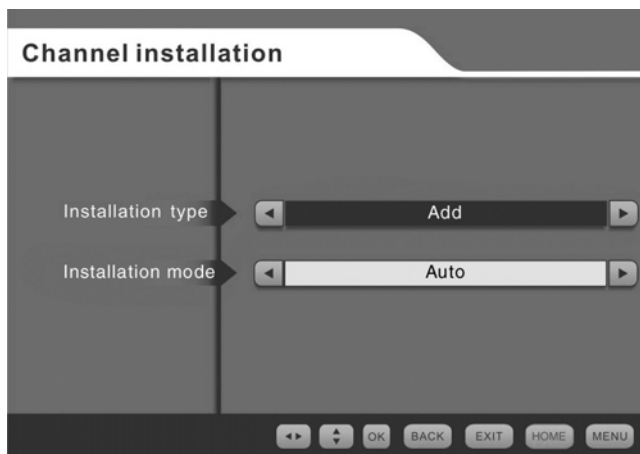

The auto channel-installation screen (3)

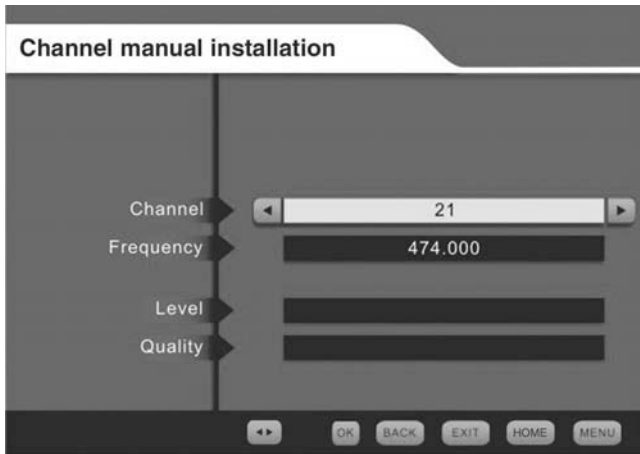

The manual channel-installation screen (4)

- 10 When the channel installation is complete, your TV will go to the first available channel in the list.

Signal information

The signal information screen gives information about the channel you're watching, including signal frequency, signal quality and signal level. This could affect your picture quality.

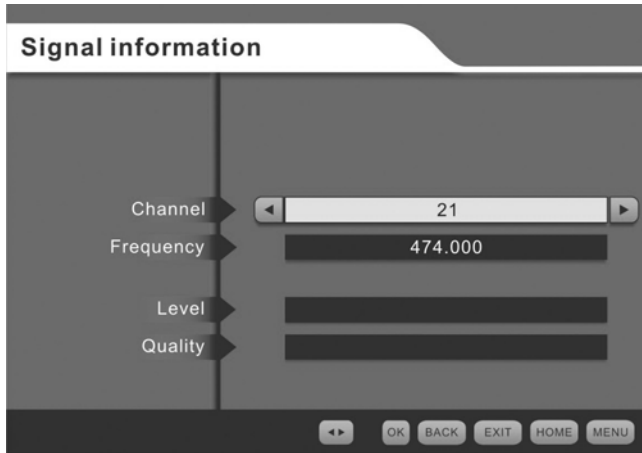

The signal information screen

The TV configuration menu

This menu lets you change selected TV configuration (setting) for your receiver.

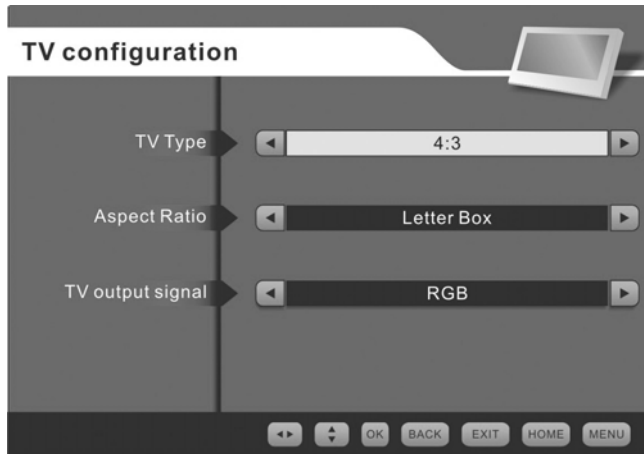

The TV configuration screen

<i>What do you want to do?</i>	<i>Press this button.</i>
Change the TV format	Select the screen type you want by using the ◀ or ▶ button (You can change between 4:3 compromise and 16:9 widescreen types.)
Change the aspect ratios (these are only available for 4:3 TV format)	Select the aspect ratios you want by pressing the ◀ or ▶ buttons (You can choose between 'letter box' 'compromise' or 'cut out'.)
Change the TV output signal	Select the format you want by pressing the ◀ or ▶ buttons (This means you can choose between RGB and CVBS signals (see below)).

Aspect ratios

You can choose from:

- letterbox;
- compromise; or
- cut out.

Choose the one that best matches your TV.

TV output signal

This option enables you to set the TV output signed format. The choices are:

- CVBS – Composite Video Blanking and Syncs. This is a signal that contains the picture information (luminance and chrominance) plus all the synchronisation signals.
- RGB – This is the option that your TV is set on when you bought it. It selects the red, green and blue parts of the video output from the SCART socket instead of the normal composite video and synchronisation signals. These primary colours are used in colour television systems that copy colour images by controlling how strong the red, green and blue light sources are on the television screen.

The languages menu

This menu lets you change the language for your TV, the information display, the audio description and the subtitles screen.

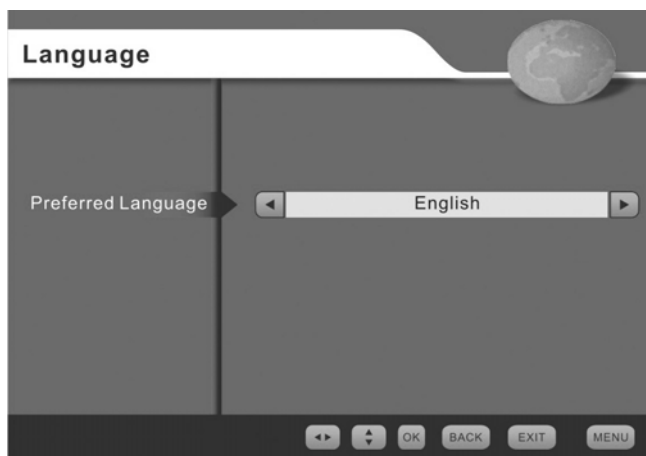

The languages menu screen

To change the language on your TV, follow these instructions.

- 1 Select the languages menu by pressing the 'OK' button.
- 2 Choose the language you want for the TV, information display, audio descriptions and subtitles using the ◀ or ▶ arrow.

The system parameters menu

This menu gives you the receiver system parameters (settings) and lets you change some of the system settings (see page 52 to select the system parameters screen).

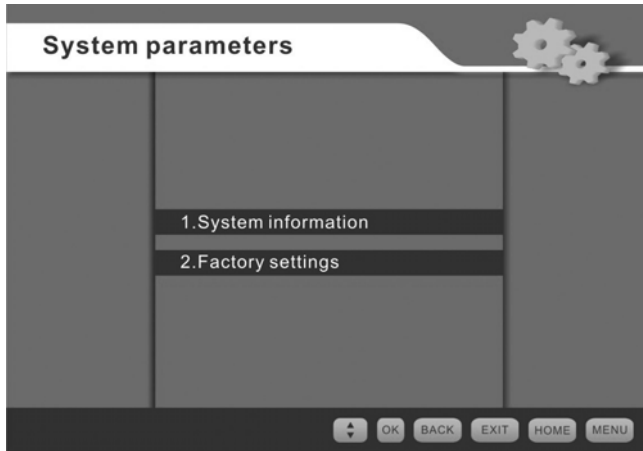

The system parameters screen

For example you may need to do this because you need to reset the receiver.

System information



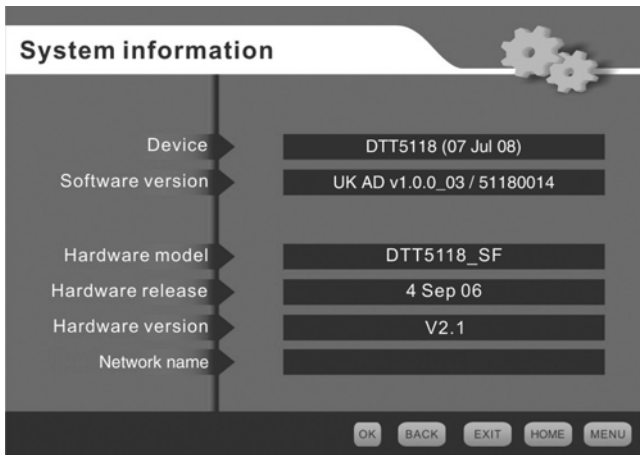

The system information screen shows information about the receiver.



The system information screen

Factory settings

The factory settings menu lets you change the receiver's settings back to the original factory settings (see page 61 to select the factory setting screen).

- 1 Using the  or  buttons, selecting 'Factory settings'.
- 2 Press the 'OK' button.
- 3 Using the  or  buttons, select 'Yes'.
- 4 Press the 'OK' button. The receiver will reset and the welcome screen will be displayed.
- 5 You will need to install channels as described on page 26.



The factory settings screen

The audio description menu

This menu lets you change the volume level of the audio description service compared to the TV volume (see page 52 to select the audio description screen). You can choose from 25% lower than the TV volume to 25% higher than the TV volume. You can also turn the key beep on or off using this menu. When the key beep is turned on, you will be able to hear a quiet beep every time a remote control button is pressed.

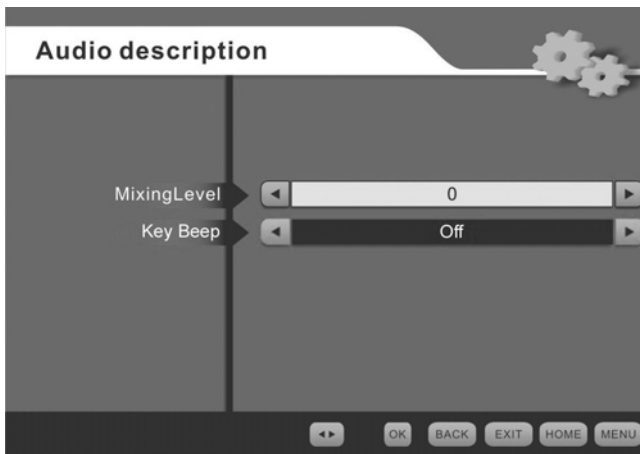

The audio description display

The RF modulator configuration menu

This menu lets you choose the RF frequency and channel number for connection option 2 (see page 12).

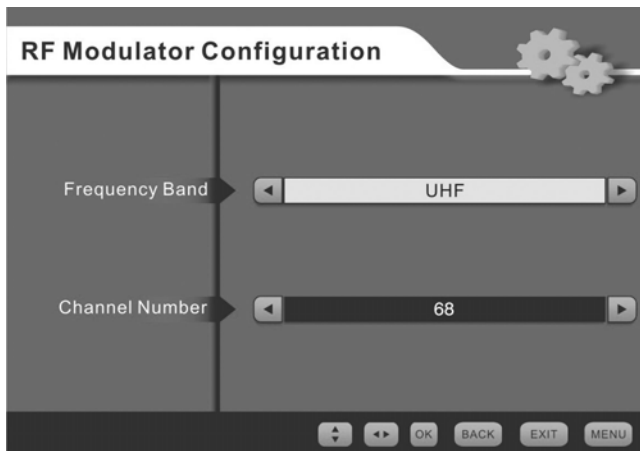

The RF modulator configuration display

<i>To</i>	<i>Which button do I press:</i>
Select the channel number for your video or DVD player	Press the ◀ or ▶ button
Confirm the menu option	Press 'OK'

You now need to go to your TV instruction manual, and scan the TV until the welcome screen appears (see page 20).

The parental control menu

This menu gives you control of the following features, so you can control when and if certain channels are watched.

- **Receiver lock** – this lets you set a pin code which you or anybody using the receiver must enter correctly before they can use the receiver.
- **Menu lock** – this lets you set a pin code which you or anybody using the receiver must enter correctly before they can change anything on a menu.
- **Channel lock** – this lets you set a pin code which you or anybody using the receiver must enter correctly before they can change any setting on the channel menu.
- **Maturity level** – this lets you choose a level, between 'none' and 'level 18', to restrict the type of programme that people can watch using the receiver. (This is up to the user to decide which channels will be set to which level).

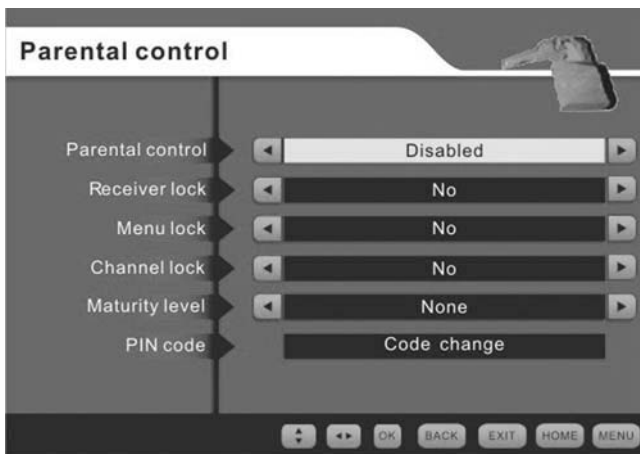

The parental control screen (1)

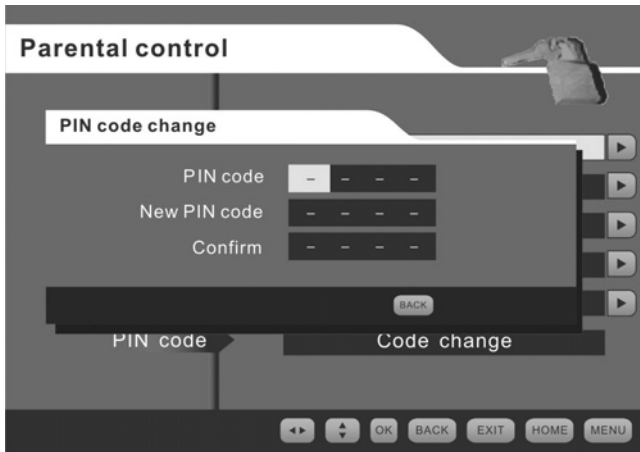

The parental control display (2)

The factory setting for the parental control PIN (personal identification number) is 0000.

You should change this PIN. When you do, remember the code or keep it written down somewhere safe.

How to reset the parental control PIN

To reset the parental control PIN, press the blue, green, red and yellow buttons twice, quickly, one after the other. (So, press the blue button twice, then the green button twice, and so on.)

<i>What do you want to do?</i>	<i>Press this button</i>
Turn parental controls off	
	(Display 1 is seen and no further options are available)
Turn parental controls on	
Confirm if you want to lock the receiver	Use the left or right arrow to choose 'Yes' or 'No'
Confirm if you want to lock the menu	Use the left or right arrow to choose 'Yes' or 'No'
Confirm if you want to lock the channel	Use the left or right arrow to choose 'Yes' or 'No'
Confirm if you want to set the maturity level	Press the left or right arrow to choose between 'none' (meaning people of any age can watch these channels) up to '18' (meaning only adults can watch these channels)
Change the pin code	Select 'Code change' and press 'OK' (When you press 'OK', you will see <what?> (see 'Display 2' on page <insert page number>.)
Insert a new pin code	<ul style="list-style-type: none"> • Select 'PIN code' and use buttons 0 to 9 to enter the most recent code • Select 'New PIN code' and use buttons 0 to 9 to enter your new code • Select 'Confirm' and use buttons 0 to 9 to re-enter your new code

You can only reset the parental control pin code by using the parental control menu.

Safety information

- Place cables where you won't walk on them. Do **not** put anything on or against them.
- Do **not** use the receiver in damp or very warm and wet conditions.
- Do **not** let the receiver get wet.
- Do **not** drip or splash anything on the receiver.
- Do **not** put anything with water in it (such as a vase) on top of the receiver.
- Do **not** put candles (or anything else with a flame) on top of the receiver.

Cleaning

- Always unplug the receiver before you clean it.
- You should clean the receiver with a soft cloth that is slightly damp.
- Do **not** use liquid or aerosol cleaners to clean the receiver.

Ventilation

- The slots and openings on the receiver are for ventilation (to let air into the receiver to keep it cool). Do **not** cover or block the slots and openings as this could make the receiver overheat.
- Never let children push anything into the slots or openings in the case.

Servicing

- There are no parts in the receiver which you can repair yourself.
- If your receiver doesn't work or you think it is broken, take it to a local electrical shop.
- Always talk to staff in the shop where you bought the receiver if you have any questions about how to set it up or how it works or about safety information.

Throwing your receiver away

- **You should not throw** electrical products away with your household waste.
- You should throw electrical products away at your local recycling centre. Your local council must provide these services in line with the Waste Electrical and Electronic Equipment (WEEE) regulations.
- Always make sure you get rid of batteries safely. Never put batteries on a fire or in the bin with normal household waste.



To find out where your nearest recycling centre is, contact your local council.

Electrical safety

Read the electrical-safety pages in this guide carefully before you connect the receiver to the mains supply.

Make sure your electricity supply is the same voltage as the voltage printed on the label on the bottom of the main unit of your receiver.

The receiver needs a 230-volt (V) 50-hertz (Hz) mains supply. Do **not** use any other supply. The receiver comes with a moulded plug. If the plug breaks, you cannot reuse the plug. If you need to change the fuse in a moulded plug you must refit the fuse cover. If you lose or damage the fuse cover, you must **not** use the plug until you have a replacement plug cover or plug.

If you have to change the plug because it is **not** suitable for your socket, or it is damaged, you should remove it and fit the right plug using the wiring diagram shown on the next page. You must throw the plug away safely. You could get an electric shock if you use it again.

The colours of the wires in the receiver's power lead may **not** match the coloured markings in your plug, so you should follow these instructions.

- You must connect the blue wire to the terminal marked with the letter 'N' or coloured black.
- You must connect the brown wire to the terminal marked with the letter 'L' or coloured red.
- You should **not** connect anything to the earth terminal of the plug marked with the letter 'E' or coloured green.

You must always use the same fuse value as your receiver's power-lead plug if you replace it.

The plug should be approved to
British Standards (BS1363/A).
Fit a 3-amp fuse.

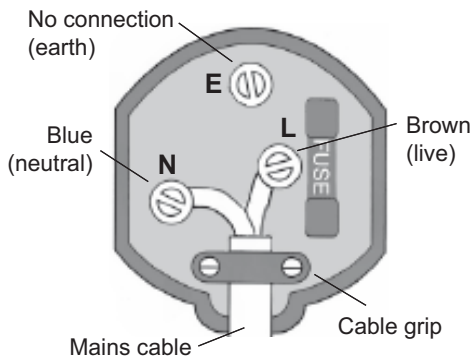

Make sure the outer sheath of the mains cable is securely held by the cable grip

Help and advice

<i>The problem you're having</i>	<i>What might be causing the problem</i>
The standby light is not on.	The power lead is either unplugged or the fuse in the power-lead plug has blown.
You cannot get a signal on your receiver	This could be because: <ul style="list-style-type: none"> • the aerial is not connected; • the aerial is damaged or pointing in the wrong direction; or • you are not in an area that can receive a digital signal.
You cannot get a picture or any sound	<ul style="list-style-type: none"> • Your TV is set to the wrong AV channel. Check the channel you are using is the right one. • Your receiver may be set to digital teletext mode
You are getting a 'scrambled channel' message	<p>You have to pay to watch this channel. The signal is encoded (scrambled) so that only people who have paid to watch the channel can see the picture.</p> <p>Phone the number on the screen for more information if you want to subscribe (pay to watch) to the scrambled channel.</p>
Your receiver is not working with the remote control	<ul style="list-style-type: none"> • The receiver is switched off. • You are not pointing the remote control at the receiver properly. • There might be something in front of the front panel on the receiver. • You may have put the batteries in the remote control the wrong way round. • You may need new batteries.
The picture is made up of square blocks or it freezes	<ul style="list-style-type: none"> • You may have the wrong type of aerial. • Your aerial may be damaged or pointing in the wrong direction.
You can only find some of the channels on your receiver	You have your favourite list selected. Check your channel list (see page 30).

If you have difficulties using your receiver and none of the suggestions above work, try switching your receiver off and then back on again.

Product specification

Plain English Campaign's Crystal Mark does **not** apply to this page.

Product specification

General

Unit size: 230 x 135.5 x 37 millimetres (width x depth x height)

Box size: 254 x 77.2 x 220.4 millimetres (W x D x H)

Unit weight: 0.5 kilograms

Power use (switched on): Less than 7 watts

Power (standby): Less than 2 watts

Major features

Converts your existing TV to digital

Includes all FREEVIEW™ channels *

No SCART connection required

Low power consumption and standby

Audio description

* FREEVIEW channels are subject to coverage and availability.
An aerial upgrade may be required

System features

2 SCART output sockets

Works with DVB-T with MHeg 5

1 tuner

Frequency band 470 to 862 MHz (UHF: only for UK)

16:9/4:3 screen aspect-ratio with pan and scan and letterbox

Full seven-day EPG day and week event functions

EPG picture in graphics

Subtitles

Teletext FLOF internal

Parental lock

Last-channel memory

Has access to all Freeview digital TV channels and radio stations

RF loop through and RF modulator output

Easy one-touch automatic set-up and tuning

Full digital text

Now and next electronic programme guide

Favourites function

Output: 2 SCART sockets, 1 earphone socket, 1 CVBS,
 2 x RCA L-R audio, 1 SPDIF

Full audio description complying with the RED Book (EC standard specification for audio description).

DTG compliant MHz 5 V1.06

Reminder functionality on EPG

Has the digital tick

Free Manuals Download Website

<http://myh66.com>

<http://usermanuals.us>

<http://www.somanuals.com>

<http://www.4manuals.cc>

<http://www.manual-lib.com>

<http://www.404manual.com>

<http://www.luxmanual.com>

<http://aubethermostatmanual.com>

Golf course search by state

<http://golfingnear.com>

Email search by domain

<http://emailbydomain.com>

Auto manuals search

<http://auto.somanuals.com>

TV manuals search

<http://tv.somanuals.com>