

electra

CLASSIQUE COOKER

MODEL EL 230W/I

INSTALLATION AND USERS'

INSTRUCTIONS

PREFACE

Welcome to your new Electra cooker. Its stylish and practical design will enhance your kitchen and make "cooking electric" a pleasure.

Features include a radiant hob for responsive, economical cooking with two large and two small radiant rings, full width grill and fan assisted oven and three removable shelves. There is also a clock / timer featuring a minute minder and automatic oven switching.

Even if you have used an electric cooker before, it is important that you read these instructions thoroughly before starting to cook, paying particular attention to the installation and safety instructions.

Getting Help

If you have any problems with installing or operating your new cooker please contact your Electricity Company for advice.

For your own safety, make sure that these instructions on installation, use and maintenance are followed.

IMPORTANT

We advise you to keep these instructions in a safe place for future reference.

If you sell or transfer ownership of this product, please pass on these instructions to the new owner.

TECHNICAL DETAILS

MODEL NO.	EL 230W/I
Voltage:	230/240 Volts AC 50Hz
Wattage:	9.6 / 10.4kW
Height:	1240mm
Width:	460mm
Depth:	585mm
Weight:	51.4kg

This appliance complies with: European Council Directive 73/23/EEC.
EMC Directive 89/336/EEC.
CE Marking Directive 93/68/EEC.

CONTENTS

Preface	1
Technical Details	2
Contents	3
Safety	4
Before Installation	4
During Operation	4
After Use	5
General	5
Introduction	6
Rating Plate	6
Installation	6
Reversible Oven Door	7
General Notes on Using your Cooker	7
About Condensation and Steam	7
Oven Indicator Neon	7
Grill and Oven Furniture	7
Getting to Know Your Cooker	8
The Control Panel	8
The Automatic Timer	9
The Radiant Hob	12
Recommended Saucepans	12
Hints and Tips	12
Deep Fat Frying	12
Preserving	13
The Grill	14
The Grill Pan and Handle	14
Hints and Tips	14
Grilling Chart	15
The Fan Oven	16
Uses of the Fan Oven	16
Selecting the Fan Oven	16
To Fit the Oven Shelves	16
Hints and Tips	16
Oven Cooking Chart	18
Roasting Chart	19
Defrost Feature	20
Uses of Defrost Feature	20
Selecting Defrost	20
Things to Note	20
Hints & Tips	20
Care and Cleaning	21
Cleaning Materials	21
Cleaning the Outside of the Cooker	21
Cleaning the Hob and Hotplate Trims	21
Cleaning the Grill Deflector, Grill and Oven Furniture	21
Cleaning Inside the Oven and Grill Compartments	21
Care of Stayclean Surfaces	21
Things to Note	21
Hints and Tips	22
Something not Working?	23
Guarantee	24
Service Call Record	25

SAFETY

THESE WARNINGS ARE PROVIDED IN THE INTERESTS OF YOUR SAFETY. ENSURE THAT YOU UNDERSTAND THEM ALL BEFORE INSTALLING OR USING THE COOKER.

PLEASE
READ
CAREFULLY



BEFORE INSTALLATION



This cooker is heavy and care **must** be taken when moving it.

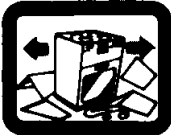

Ensure that all packaging, both inside and outside the cooker has been removed before the cooker is used.



Do not try to move the cooker by pulling the door handles.



The electrical installation work **must** be undertaken by a qualified electrician/ competent person.

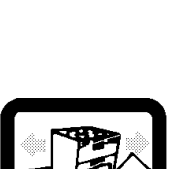

After installation, please dispose of the packaging with due regard to safety and the environment.

DURING OPERATION



Do not use this cooker if it is in contact with water and **never** operate it with wet hands.



This cooker is designed to be operated by adults. Young children **must not** be allowed to tamper with the cooker or play with the controls.

Accessible parts especially around the grill area, may become hot when the cooker is in use. Children should be **kept away** until it has cooled.



Take **great care** when heating fats and oils as they will ignite if they become too hot.

This cooker has been designed for cooking edible foodstuffs only, and **must not** be used for any other purposes.



Never place plastic or any other material which may melt in the oven or on the hob.



Ensure cooking utensils are large enough to contain foods to prevent spillages and boil overs.

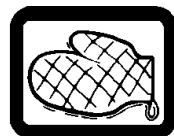

The handles of saucepans which are smaller than the heated area on the hob will become hot. **Ensure** your hand is protected before handling the pan.



Take care to follow the recommendations given for tending the food when grilling.

Do not leave the grill pan handle in position when grilling as it will become hot.

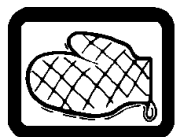

Always use oven gloves to withdraw the grill pan, when grilling. Follow the recommendations on page 14.

Ensure that all vents are left unobstructed to ensure ventilation of the oven cavity.

Ensure that the anti-tilt shelves are put in place correctly. Refer to instructions on pages 16.

Never line any part of the cooker with aluminium foil.



Always stand back from the cooker when opening the oven door to allow any build up of steam or heat to release.



Do not place sealed cans or aerosols inside the oven. They may explode if they are heated.

AFTER USE



Ensure that all control knobs are in the OFF position when not in use.



For hygiene and safety reasons this cooker should be kept clean at all times. A build-up of fats or other foodstuffs could result in a fire, especially in the grill pan.



Do not leave utensils containing foodstuffs, e.g. fat or oil in or on the cooker in case it is inadvertently switched ON.

Cookers and hobs become very hot, and retain their heat for a long period of time after use. Children should be kept well away from the cooker until it has cooled.

GENERAL



Under no circumstances should repairs be carried out by an inexperienced person as this may cause injury or serious malfunction. This cooker should be serviced by an authorised Service Engineer and only genuine-approved spare parts should be used. Details of repair and servicing arrangements are supplied on page 25 of this book.



Do not stand on the cooker or on the open oven door.



Do not hang towels, dishcloths or clothes from the cooker or its handle. They are a safety hazard.

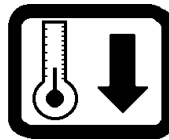

Always switch OFF the cooker at its power point and allow the cooker to cool before any maintenance or cleaning work is carried out.



Only clean this cooker in accordance with the instructions given in this book.

Your safety is of paramount importance.

Therefore, if you are unsure about any of the meanings of these WARNINGS contact your local Electricity Company.

INTRODUCTION

WARNING: THIS COOKER MUST BE EARTHED

RATING PLATE

Record the model, product and serial numbers inside the back cover of this instruction book from the rating plate. This is situated on the lower front frame of the cooker and can be seen upon opening the oven door.

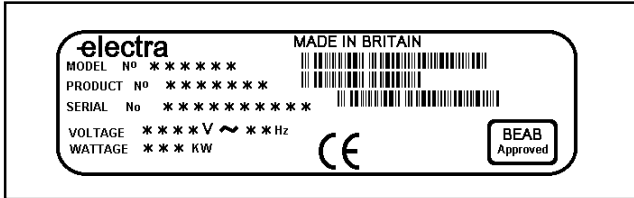

The cooker must be protected by a suitably rated fuse or circuit breaker. The rating of the cooker is given on the rating plate.

INSTALLATION

If your cooker has been damaged in transit, contact your supplier immediately. **DO NOT** attempt to install it.

Your cooker left the factory fully packaged to protect it from damage. If it is delivered without packaging and damage has occurred, the manufacturer cannot accept responsibility. Contact your supplier for advice.

Once the packaging has been removed the cooker should only be moved by hand. **DO NOT** use a sack barrow or any other aid to lift the cooker as damage may occur.

Connection to the electricity supply must be carried out by a qualified electrician/competent person.

The electrical connection should be made using a double pole isolating switch (cooker socket) with at least 3mm contact separation in all poles. The cable must have conductors of sufficiently high cross-sectional area to prevent overheating and deterioration.

Six square millimetres (6.00mm²) is the recommended cross-section area.

The cable should be routed away from potentially hot areas marked by an ' X ' in the diagram below.

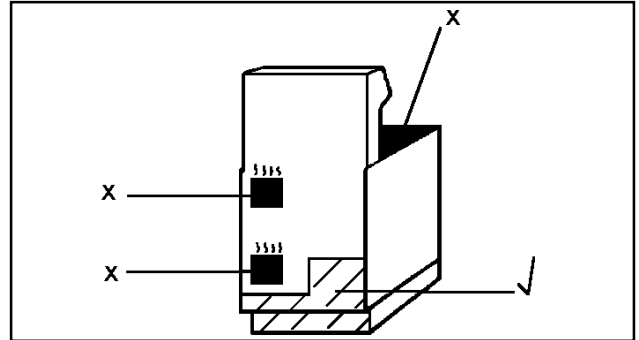

This is a type Y appliance which means it is free-standing and can be fitted with cabinets on one or both sides. It may also be fitted in a corner setting.

Side walls which are above hob level should be protected by heat resistant non-combustible material and **MUST NOT** be nearer than 40mm to the hob side.

A nominal air gap of 10mm at the sides of the cooker is required to enable the cooker to be moved into position.

Overhanging surfaces or a cooker hood should be a minimum of 685mm above the hob.

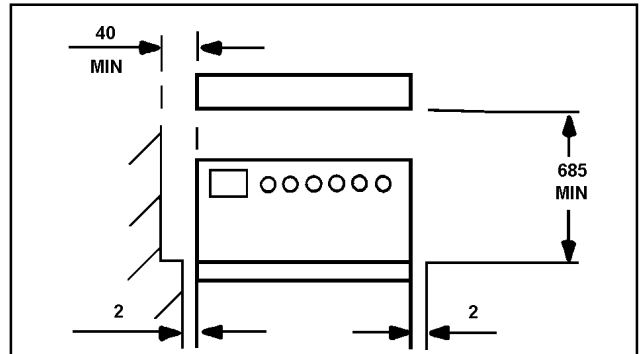

It is important to ensure that the appliance is level after installation. Levelling feet are fitted to the front of the appliance to accommodate uneven floors.

To move the cooker, open the oven door, and lift the cooker by holding inside the top of the oven compartment.

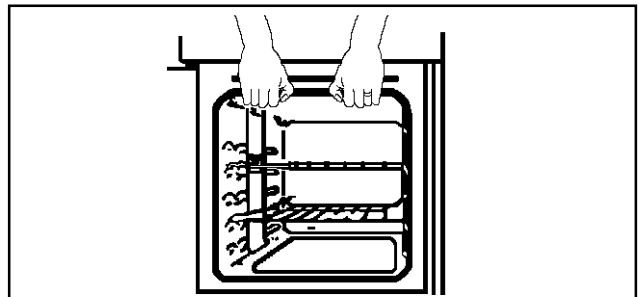

REVERSIBLE OVEN DOOR

If you require the oven door to be hinged on the opposite side, you will need to contact your local Electricity Company's Service Department. PLEASE NOTE that a charge may be made.

GENERAL NOTES ON USING YOUR COOKER

We suggest that you run the oven elements for 10 - 15 minutes at 220°C to burn off any residue from their surfaces.

The procedure should be repeated with the grill for approximately 5 - 10 minutes.

During this period an odour may be emitted, it is therefore advisable to open a window for ventilation.

ABOUT CONDENSATION AND STEAM

When food is heated it produces steam similar to a boiling kettle. The ovens are vented to allow some of this steam to escape. However, always stand back from the cooker when opening the oven door to allow any build up of steam or heat to release.

If the steam comes into contact with a cool surface on the outside of the cooker, e.g. a trim, it will condense and produce water droplets. This is quite normal and is not caused by a fault on the cooker.

To prevent discolouration, regularly wipe away condensation and also soilage from surfaces.

For your safety wall coverings at the rear of the appliance should be securely fixed to the wall.

OVEN INDICATOR NEON

This light indicates whether the oven is switched on. It also indicates when the set temperature has been reached. It will turn on and off during use to show that the temperature is being maintained.

GRILL AND OVEN FURNITURE

The following items of grill/oven furniture have been supplied with the cooker.

1 grill pan



1 grill pan handle

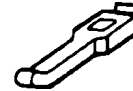

1 grill pan grid

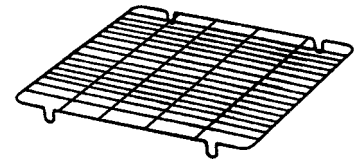

1 grill deflector



3 straight shelves for oven cooking

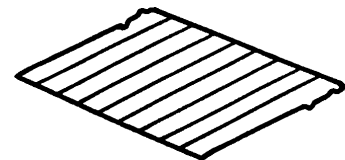

Scuffing of the Stayclean oven coating by the oven furniture pack may occur during transit. These marks will disappear after the oven elements have been burnt off for the first time.

GETTING TO KNOW YOUR COOKER

THE CONTROL PANEL

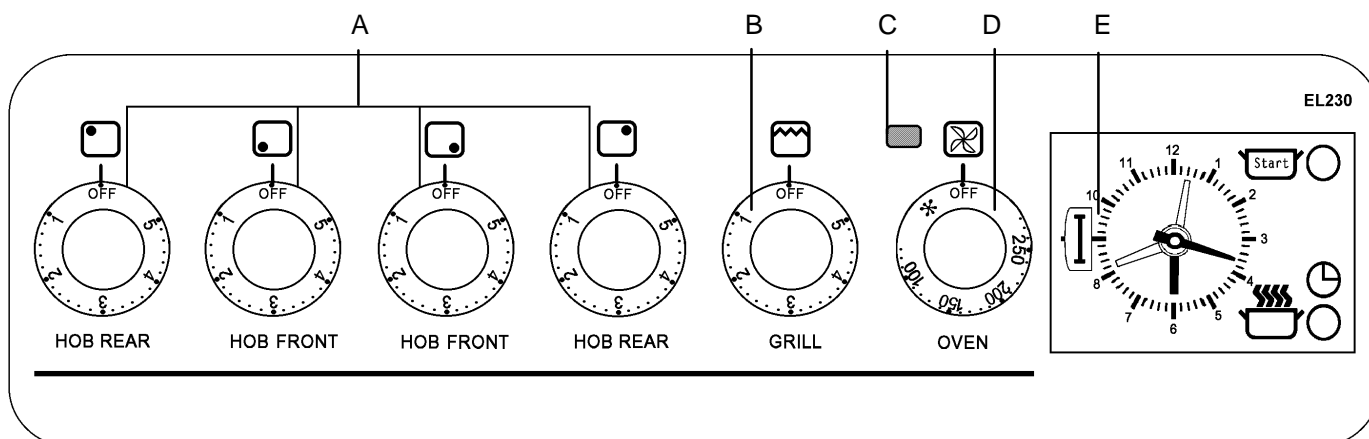

FEATURES

- A - Hotplate Controls
- B - Grill Control
- C - Oven Indicator Neon
- D - Oven Temperature Control
- E - Automatic Timer

THE AUTOMATIC TIMER

- A START TIME SETTING KNOB
- B SECOND HAND
- C CLOCK SYMBOL
- D CLOCK/MINUTE MINDER/LENGTH OF COOKING TIME SETTING KNOB
- E START TIME INDICATOR
- F HOUR HAND
- G DISPLAY WINDOW
- H MANUAL SYMBOL
- J MINUTE HAND

1. TO SET THE TIME OF DAY

The clock will operate when the cooker is switched ON at the wall.

To set, **pull out** and turn setting knob (D) clockwise until the right time of day is displayed, e.g. 9 a.m. as Fig. 1.

2. TO SET FOR MANUAL COOKING

Ensure the time of day has been set as above.

Push in and turn setting knob (A) in either direction until the start time indicator (E) lines up with the hour hand of the clock.

Push in and turn setting knob (D) clockwise until the manual symbol (H) can be seen in window (G) as Fig. 2.

The oven temperature control can now be operated as required. The oven neon indicator will glow.

3. TO SET THE MINUTE MINDER

Turn setting knob (D) clockwise, **without pulling it out**. The selected minutes can be seen in the window (G), e.g. 80 minutes as Fig. 3.

A period of up to 3 hours can be timed using the minute minder. The minute minder cannot be used when an automatic programme has been set on the oven timer.

At the end of the set time a continuous buzzer will sound for up to 6 minutes.

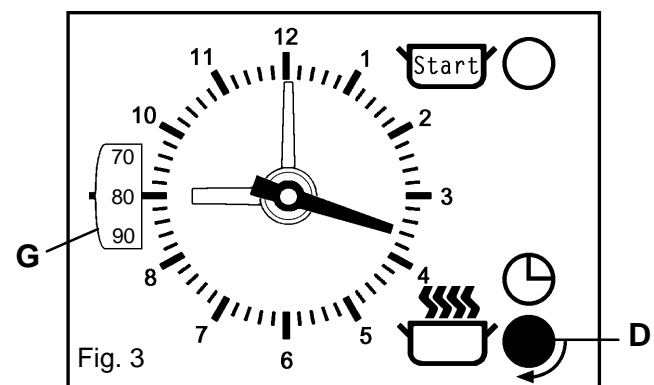
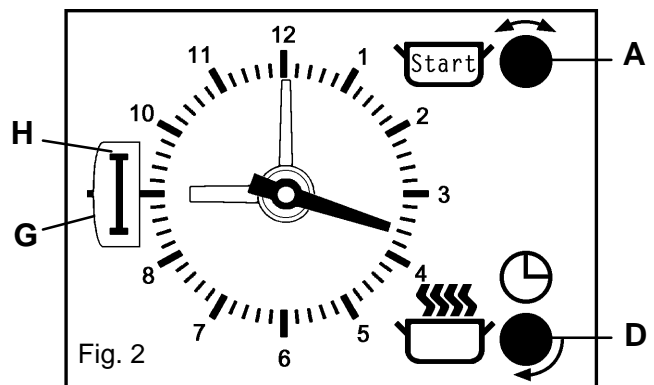
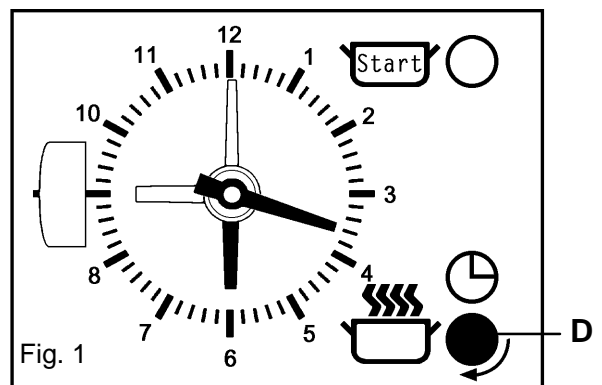
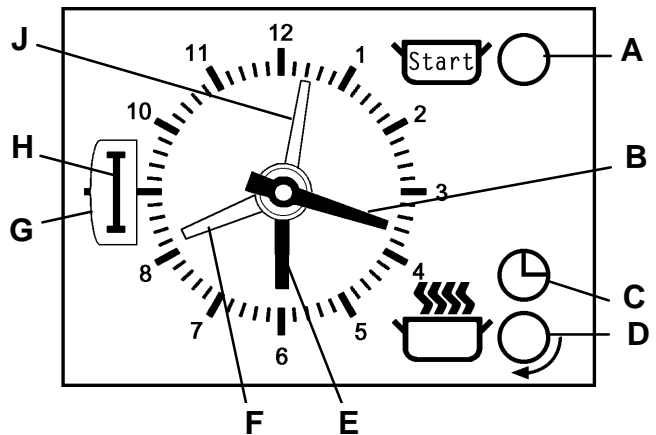

4. TO CANCEL MINUTE MINDER/BUZZER

Turn setting knob (D) clockwise, **without pulling it out** until "O" or the manual symbol appears in the window (G) as Fig.4.

5. HOW TO SET THE OVEN TIMER

When using the oven timer for the very first time, it is advisable to let it operate while you are at home. The timer can be checked to show that it is operating correctly and then you will then feel confident to leave a meal to cook automatically in the future.

A) TO SWITCH THE OVEN ON AND OFF AUTOMATICALLY

- i) Make sure the electricity supply is switched ON.
- ii) Check the clock shows the right time of day and the cooker is set in manual (see point 2). Adjust as necessary as Fig. 5.
- iii) Place food in oven.
- iv) To set the length of time you want the food to cook; turn setting knob (D) clockwise, **without pulling it out**, until the required cooking period can be seen in the window (G) e.g. 160 minutes (2 hours 40 mins) as Fig. 6.
- v) Set the start time, by **pushing in** and turning setting knob (A) in either direction until indicator (E) lines up with the time you want the food to start cooking, e.g. 1.30 p.m. as Fig. 7.
- vi) Turn the oven temperature control to the required setting. The oven indicator neon should be OFF.
- vii) When automatic cooking starts the oven indicator neon will turn ON and OFF showing that the oven temperature is being maintained.
- viii) The start time indicator (E) will move with the hour hand of the clock until the length of cooking time is complete. A buzzer will sound which can be cancelled by following point 4 as Fig. 8.
- ix) The maximum cooking time on automatic is 3 hours.

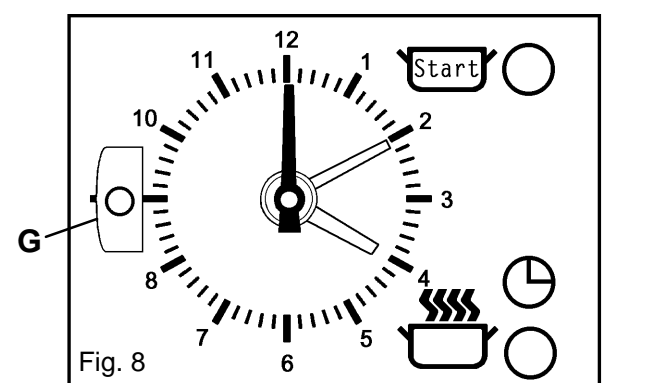
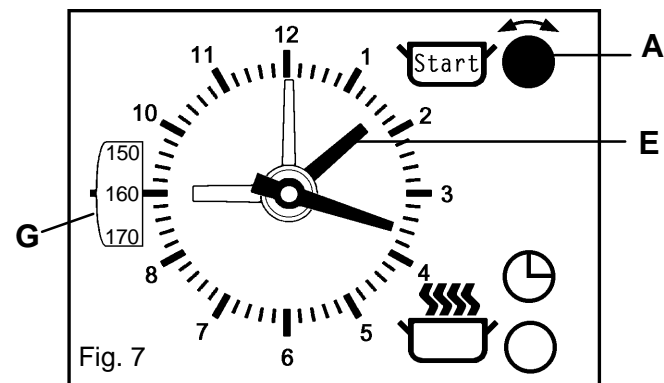
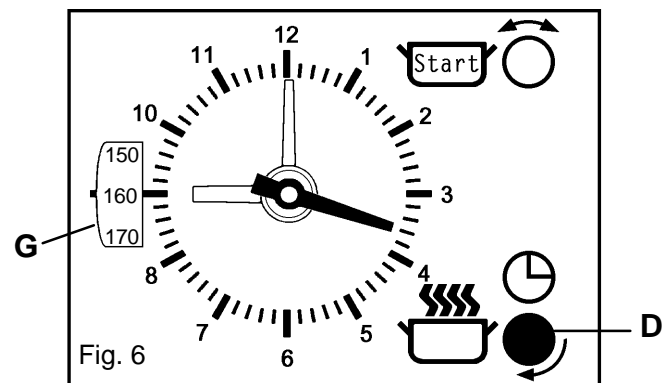
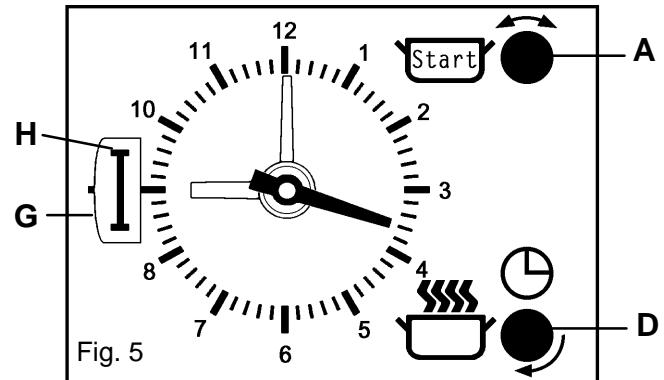
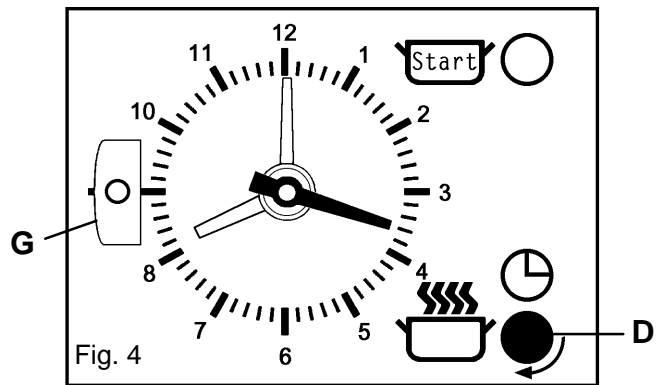

B) TO START COOKING NOW, THEN SWITCH OFF AUTOMATICALLY

Follow the first 3 points under section 5. (A) above, and then;

- iv) To set the length of time you want the food to cook; turn setting knob (D) clockwise, **without pulling it out**, until the required cooking period can be seen in window (G), e.g. 120 minutes (2 hours) and Fig. 9.
- v) Turn the oven temperature control to the required setting. The oven indicator neon should glow.
- vi) The oven indicator neon will turn ON and OFF showing that the oven temperature is being maintained.
- vii) The start time indicator (E) will move with the hour hand of the clock until the length of cooking time is complete. A buzzer will sound which can be cancelled by following point 4 as Fig. 10.

6. RETURNING THE COOKER TO MANUAL OR TO CANCEL AN AUTOMATIC PROGRAMME

Turn the oven temperature control OFF. Ensure the start time indicator (E) lines up with the hour hand of the clock by **pushing in** and turning in either direction, setting knob (A). Fig. 11.

The manual symbol (H) should be displayed in window (G) by turning setting knob (D) clockwise.

Turn the oven temperature control ON to check that the oven operates manually. The oven neon indicator should light.

7. THINGS TO NOTE

- * If an automatic programme has been set on the oven, the grill **WILL** operate manually.
- * The delay time plus the cooking time **MUST NOT** exceed 11 hours and 59 minutes.

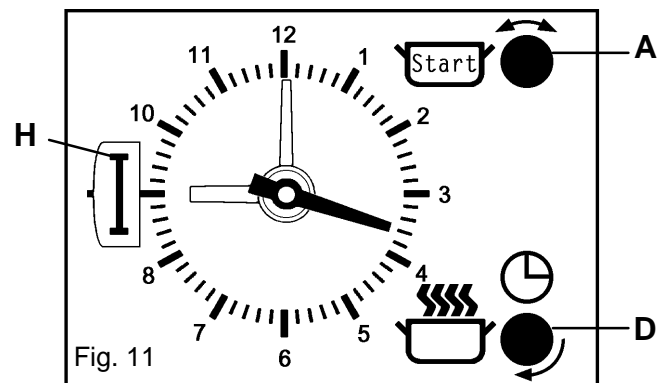
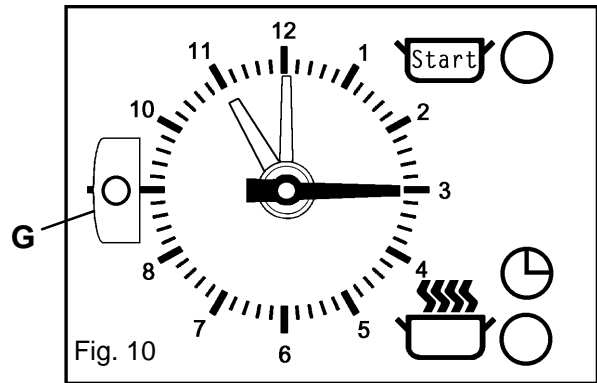
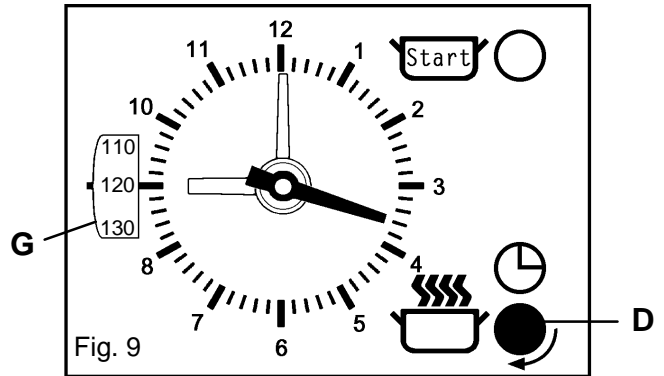

THE RADIANT HOB

USING THE HOB

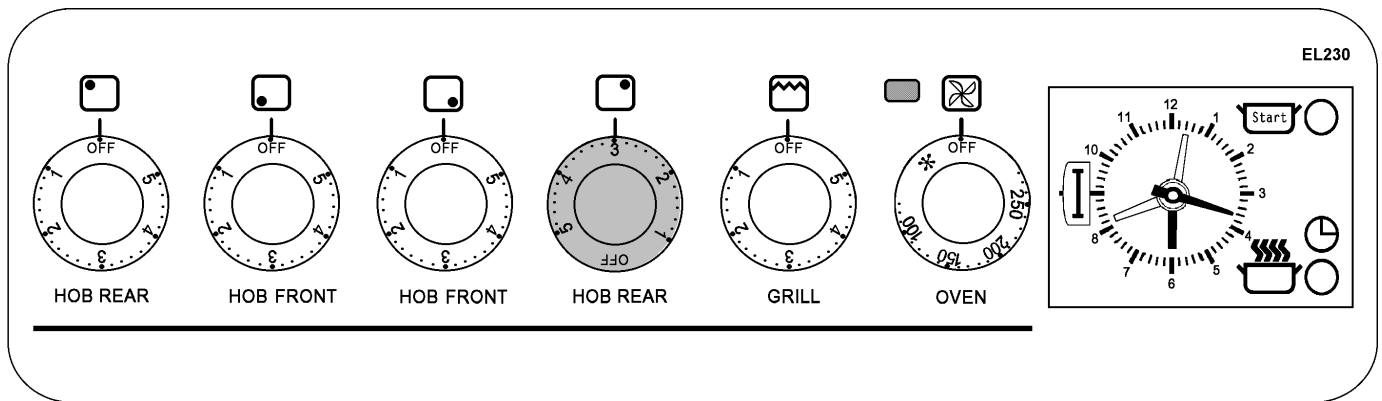

- To operate the hotplates, turn the control knobs clockwise from the OFF position to the required setting.
- The highest number represents the hottest setting and the lowest number the coolest setting. Choose a setting appropriate to the quantity and type of food to be cooked.

RECOMMENDED SAUCEPANS

For speed and economy only good quality saucepans with flat bases and close fitting lids are recommended.

The saucepan base should cover the hotplate as much as possible. A base diameter of up to 225mm (9") may be used on a 180mm (7") hotplate.

Pressure cookers, preserving pans, etc., should comply with the recommendations given above. Traditional round bottomed Woks must not be used even with a stand. Woks with flat-bottomed bases are available and do comply with the above recommendations.

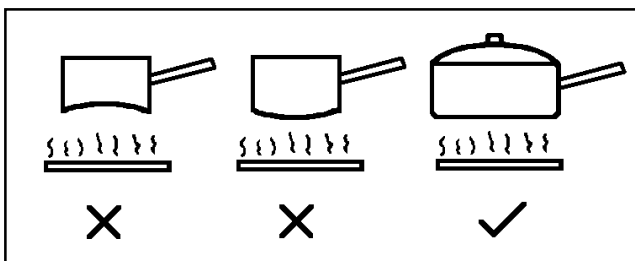

HINTS AND TIPS

- Lift, rather than slide saucepans on and off the hotplates. This will help to reduce scratches and maintain the efficiency of the hotplate.

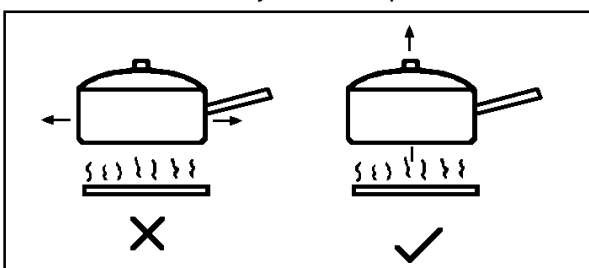

- Avoid placing fish kettles or large preserving pans across two hotplates as this may cause damage.

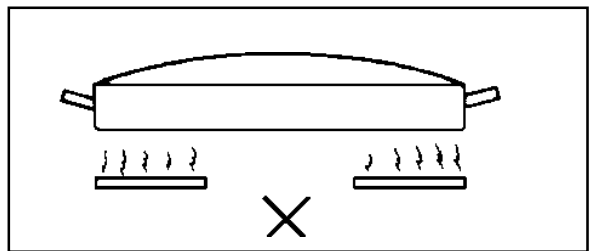

- Follow any guidelines provided by the saucepan manufacturer, particularly those relating to recommended heat settings.
- To prolong the life of the hotplates:-
 - Never use utensils with a skirt, e.g. a bucket.
 - Never use an asbestos mat.
 - Never line the spillage tray with aluminium foil
 - Never leave the hotplates ON when not covered with a saucepan.

DEEP FAT FRYING

SPECIAL FRYING NOTE:

For safety purposes when deep fat frying, fill the pan one-third full of oil, DO NOT cover the pan with a lid and DO NOT leave the pan unattended. In the unfortunate event of a fire, switch the cooker OFF at the electricity supply and cover the pan with a lid or damp cloth to assist in smothering the flames.

DO NOT use water on the fire. Leave the pan to cool for at least 30 minutes before moving it.

DO NOT leave the fat or oil in the frying pan on the hob to store it in case the hob is inadvertently switched ON.

1. Preparing the food.

Seal the food by coating with flour, egg and breadcrumbs or batter. **Do not** use a basket with batter coated foods as they will stick.

2. Amount of oil.

For safety purposes fill the pan only one-third full of oil.

3. Testing the temperature of the oil.

It is advisable to use a thermometer to test the temperature of the oil. Alternatively, drop a small cube of bread into the oil which should brown in just under a minute if the oil is at the correct temperature of 190°C/375°F.

4. Cooking the food.

Lower the food gently into the oil. **Do not** add too much food at once or the temperature of the oil will be reduced and may result in soggy, greasy food.

Turn the food if necessary; doughnuts float to the surface so will not brown on the upperside if not turned. Once cooked, drain the food on absorbent paper.

5. Double frying chips.

Double frying will ensure good chips. First fry the chips for a few minutes at 170°C/340°F to seal the outside. Remove the chips from the oil. Increase the temperature of the oil to 190°C/375°F to finish cooking and brown the chips.

Chips may be kept for several hours after the first frying before finishing off with the second frying.

6. Frying temperatures

	Celsius Scale (°C)	Fahrenheit Scale (°F)
	150	300
First frying of potatoes	170	340
	175	350
	180	360
Second frying of potatoes	190	375
Frying chicken and fish	195	380
	200	390

PRESERVING

1. DO NOT use a pan that overlaps the perimeter of the hob trim.

2. To allow for a full rolling boil, the pan should be no more than one third full when all the ingredients have been added. It is better to use two pans rather than overfill one, or use half quantities.

3. Use firm fruit or vegetables and wash well before using.

4. Preserving sugar gives clear jam, however granulated sugar is cheaper and gives equally good flavour.

5. Crystallization may be caused if sugar is not completely dissolved before bringing jam to the boil. Over boiling will affect the flavour, setting properties and colour of the jam.

6. To test jam for setting:

If a jam thermometer is available, boil jam to 104°C. Marmalade should be boiled to 106°C.

If a jam thermometer is not available, remove pan from heat, place sample of jam on a cold dish and cool quickly (i.e. in a freezer or frozen food storage compartment of a refrigerator). When cold, it will crinkle and hold the mark of a finger run through it, if it is ready.

7. The scum should be removed as soon as possible after setting point has been reached. Marmalade should be allowed to cool before potting to prevent the peel rising.

THE GRILL

CAUTION - ACCESSIBLE PARTS MAY BECOME HOT WHEN THE GRILL IS IN USE. CHILDREN SHOULD BE KEPT AWAY.

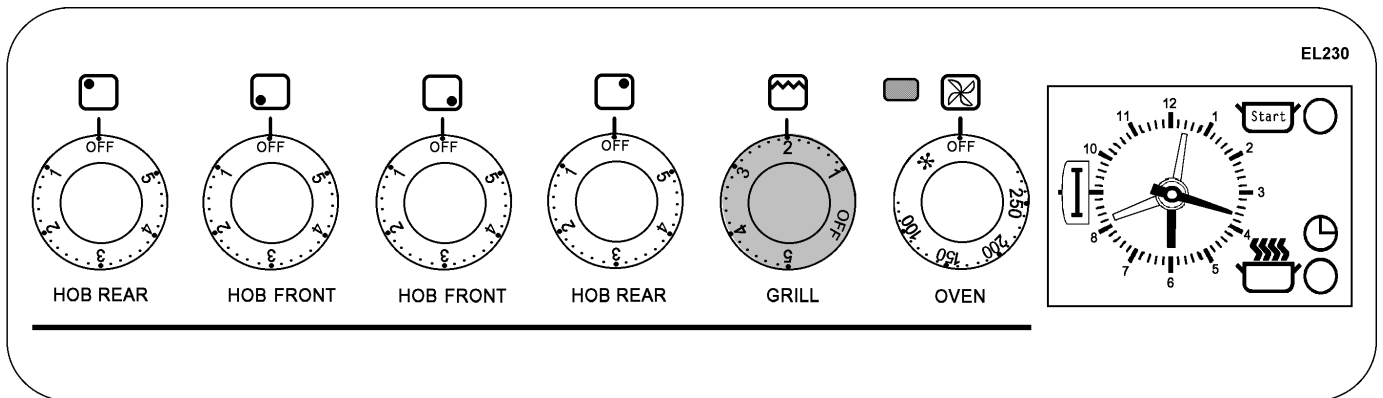

- To operate the grill, turn the grill control clockwise from the 'OFF' position to the required setting.
- The highest number represents the hottest setting and the lowest the coolest setting.

NOTE

THE GRILL DOOR MUST BE LEFT OPEN DURING GRILLING.

THE GRILL PAN AND HANDLE

The grill pan is supplied with a removable handle.

To insert the handle, press the button on the handle with the thumb and pivot the handle slightly upwards inserting the lip into widest part of the bracket. Move the handle towards the left, lower into position and release the button.

Ensure the handle is positively located.

When removing the handle, press the button on the handle with the thumb and pivot the handle slightly upwards and towards the right to remove from the bracket.

Ensure your hand is protected with an oven glove when removing the grill pan handle as the grill element can become very hot.

ALWAYS REMOVE THE GRILL PAN HANDLE DURING GRILLING.

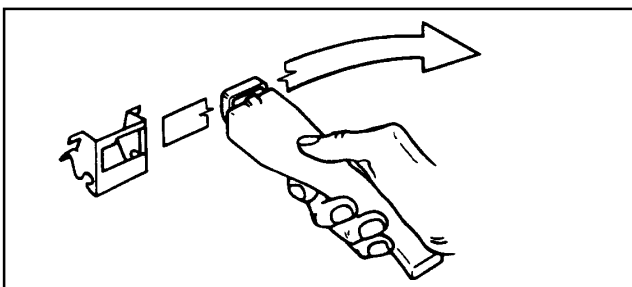

To correctly locate the grill pan ensure the pan locates into the runners in the grill compartment side panels. There are two grilling positions.

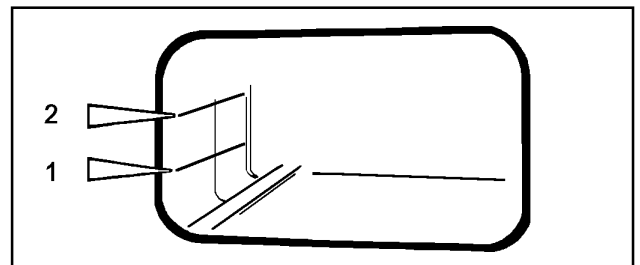

To check the progress of the food being grilled, the grill pan should be withdrawn on the runners to attend to food during cooking or the grill pan can be lifted away from the cooker and rested on a heat resistant work surface.

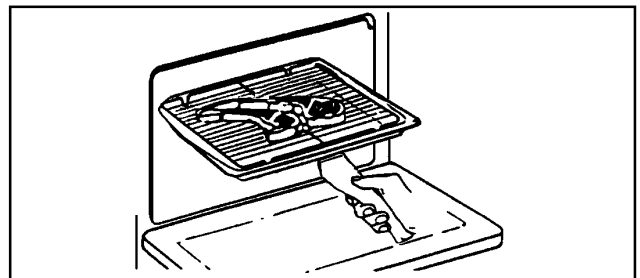

HINTS AND TIPS

- Food should be thoroughly dried before grilling to minimise splashing. Brush lean meats and fish lightly with a little oil or melted butter to keep them moist during cooking.
- Adjust the height of the grilling grid and grill pan runner position to allow for different foods.

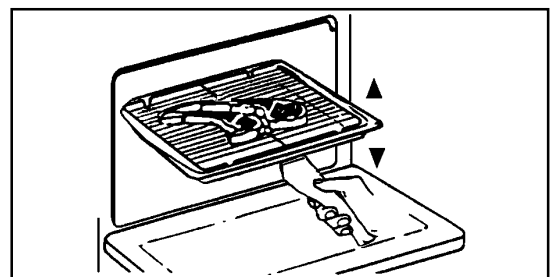

- When toasting bread use the top runner position. Adjust the grill pan grid to suit.
- Accompaniments such as tomatoes and mushrooms may be placed underneath the grid when grilling meats.

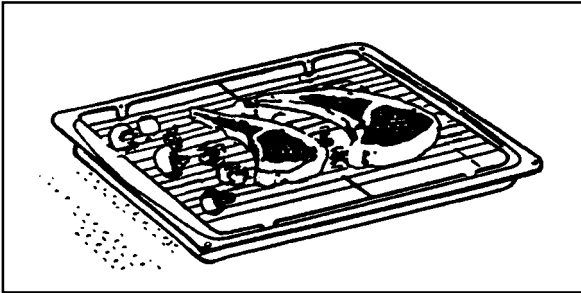

- Preheat the grill on a full setting for a few minutes before cooking. Adjust the heat setting and runner position as necessary during cooking.
- The food should be turned over during cooking as required.

GRILLING CHART

FOOD	RUNNER POSITION	GRILL TIME (mins in total)
Bacon Rashers	2	5-6
Beefburgers	2	10-15
Chicken Joints	2	30-40
Chops - Lamb	2	15-20
Pork	2	20-30
Fish - Whole	2	
Trout/Mackerel	2	15-25
Fillets - Plaice/Cod	2	10-15
Kebabs	2	20-30
Kidneys - Lamb/Pig	2	8-12
Liver - Lamb/Pig	2	10-20
Sausages	2	20-30
Steaks - Rare	2	6-12
Medium	2	12-16
Well Done	2	14-20
Toasted Sandwiches	2	3-4

Runner positions are counted from the bottom upwards.

The times quoted above are given as a guide and should be adjusted to suit personal taste.

Adjust the grill pan grid to suit the type and thickness of food to be cooked.

THE FAN OVEN

USES OF THE FAN OVEN

PREHEATING

The fan oven quickly reaches its temperature, so it is not usually necessary to preheat the oven. Without preheating, however, you may find you need to add an extra 5 - 10 minutes on the recommended cooking times. For recipes needing high temperatures, e.g. bread, pastries, scones, soufflés, etc., best results are achieved if the oven is preheated first.

COOKING TEMPERATURES

Fan oven cooking generally requires lower temperatures than conventional cooking. Follow the temperatures recommended in the charts on pages 18 & 19. As a guide reduce temperatures by about 20°C - 25°C for your own conventional oven recipes.

BATCH BAKING

The fan oven cooks evenly on all shelf levels, especially useful when batch baking.

SELECTING THE FAN OVEN

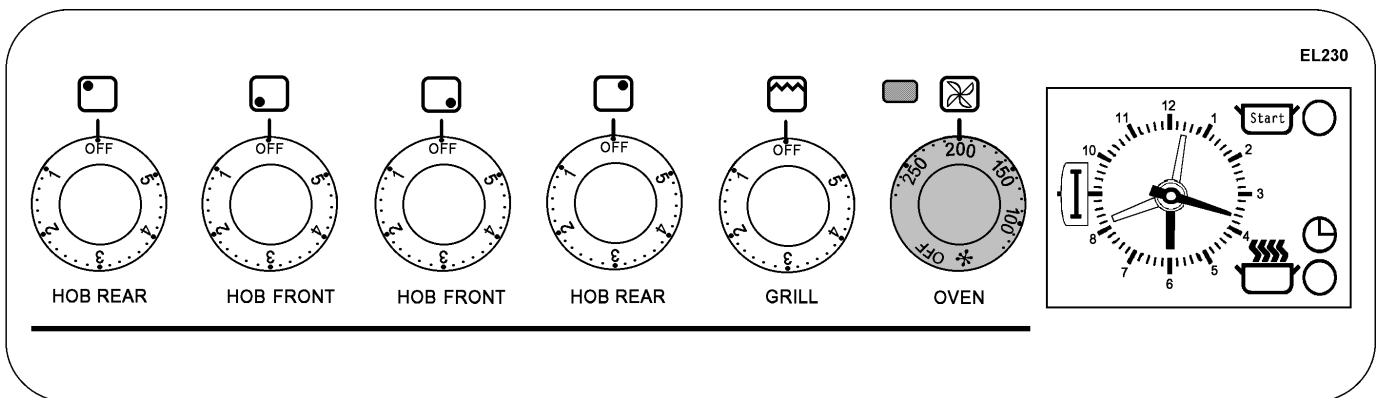

- To operate the oven turn the oven temperature control to the required setting.
- The oven indicator neon will glow until the oven has reached the required temperature and then go out. It will turn ON and OFF periodically during cooking showing that the temperature is being maintained.

TO FIT THE OVEN SHELVES

The shelves should be fitted with the straight rods uppermost on the frame and the forms towards the back of the oven. If not fitted correctly the anti-tilt and safety stop mechanism will be affected.

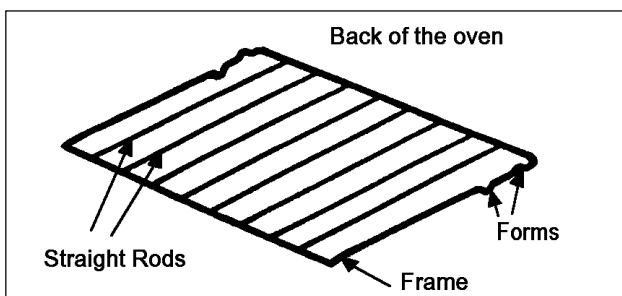

HINTS AND TIPS

- Arrange the shelves in the required positions before switching the oven ON. Shelves are numbered from the bottom upwards.

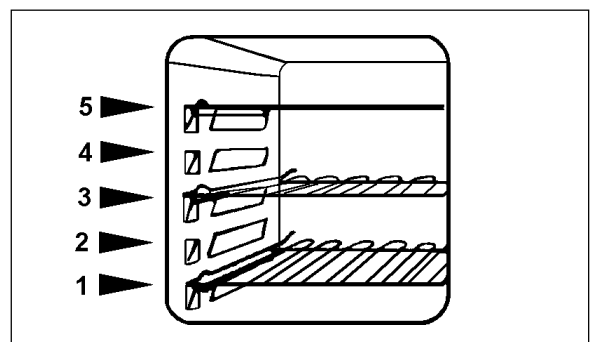

- When cooking more than one dish in the fan oven, place dishes centrally on different shelves rather than cluster several dishes on one shelf. This will allow the heat to circulate freely for the best cooking results.
- When batch baking one type of food, e.g. Victoria sandwich cakes, those of similar size will be cooked in the same time.

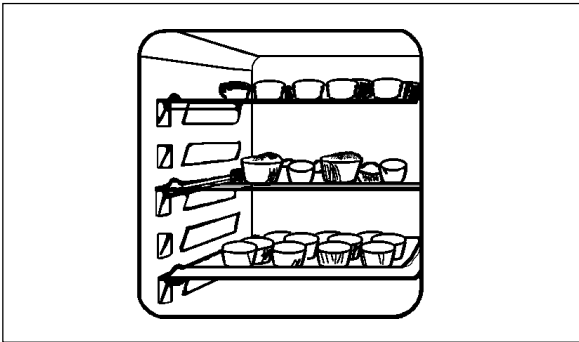

- It is recommended that when baking larger quantities, the shelf positions should be evenly spaced to suit the load being cooked. A slight increase in cooking time may be necessary.
- Do not place dishes or baking trays directly on the oven floor as it interferes with the oven air circulation and can lead to base burning; use the lower shelf position. However non critical dishes can be placed on the oven base when more space is required.

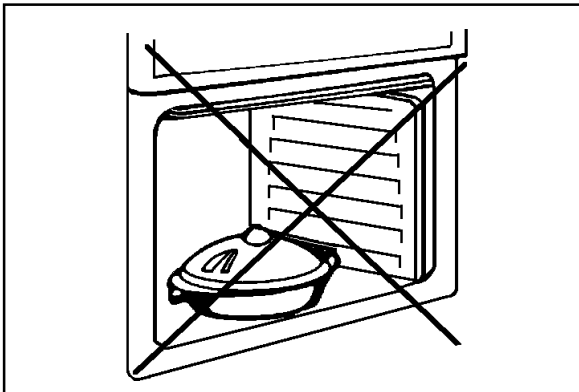

- The use of excessively high temperatures can cause uneven browning. It may be necessary to reduce temperatures slightly. Refer to the recommendations given in the oven cooking chart on page 18.

OVEN COOKING CHART

The oven temperatures are intended as a guide only. It may be necessary to increase or decrease the temperature by 10°C to suit individual preferences and requirements.

FOOD	FAN OVEN	
	SHELF POSITION	COOKING TEMP °C
Biscuits		180-190
Bread		200-220
Bread rolls/buns	Shelf	200-220
Cakes:		
Small & Queen		160-170
Sponges		160-170
Victoria Sandwich	positions	160-170
Madeira		140-150
Rich Fruit		130-140
Christmas	are not	130-140
Gingerbread		140-150
Meringues		80-100
Flapjack	critical	170-180
Shortbread		130-140
Casseroles:		
Beef/lamb		140-160
Chicken	but ensure	180-190
Convenience Foods		Follow manufacturer's instructions
Fish		170-190
Fish Pie (Potato Topped)	that oven	190-200
Fruit Pies, Crumbles		190-200
Milk Puddings		130-140
Pasta, Lasagne etc.	shelves are	190-200
Pastry:		
Choux		190-200
Eclairs, Profiteroles		170-180
Flaky/Puff Pies	evenly	210-220
Shortcrust		
Mince Pies		190-200
Meat Pies		190-210
Quiche, Tarts, Flans	spaced	180-210
Patés and Terrines		150-160
Roasting Meat, Poultry		160-180
Scones	when more	210-220
Shepherd's Pie		190-200
Soufflés		170-180
Vegetables:	than one is	180-190
Roast Potatoes		180-190
Stuffed Marrow		180-190
Stuffed Tomatoes	used	180-190
Yorkshire Puddings:		
Large		210-220
Individual		200-210

ROASTING CHART

The oven temperatures are intended as a guide only. It may be necessary to increase or decrease the temperatures by 10° C to suit individual preferences and requirements.

The roasting temperatures and times given in the chart should be adequate for most joints, but slight adjustments may be required to allow for personal requirements and the shape and texture of the meat. However, lower temperatures and longer cooking times are recommended for less tender cuts or larger joints.

Wrap joints in foil if preferred, for extra browning uncover for the last 30 - 60 min. cooking time.

ROASTING CHART		
INTERNAL TEMPERATURES - Rare: 50-60°C; Medium: 60-70°C; Well Done: 70-80°C		
MEAT	FAN OVEN	COOKING TIME
Beef	160-180°C	20-35 minutes per ½kg (1lb) and 20-35 minutes over
Beef, boned	160-180°C	25-35 minutes per ½kg (1lb) and 25-35 minutes over
Mutton and Lamb	160-180°C	25-35 minutes per ½kg (1lb) and 25-35 minutes over
Pork and veal	160-180°C	30-40 minutes per ½kg (1lb) and 30-40 minutes over
Ham	160-180°C	30-40 minutes per ½kg (1lb) and 30-40 minutes over
Chicken	160-180°C	15-20 minutes per ½kg (1lb) and 20 minutes over
Turkey and goose	160-180°C	15-20 minutes per ½kg (1lb) up to 3½kg (7lb) then 10 minutes per ½kg (1lb)
Duck	160-180°C	25-35 minutes per ½kg (1lb) and 25-30 minutes over
Pheasant	160-180°C	35-40 minutes per ½kg (1lb) and 35-40 minutes over
Rabbit	160-180°C	20 minutes per ½kg (1lb) and 20 minutes over
Potatoes with meat	160-180°C	according to size
Potatoes without meat	180-190°C	according to size

DEFROST FEATURE

USES OF DEFROST FEATURE

This fan oven function defrosts most foods faster than more conventional methods. It is particularly suitable for delicate frozen foods which are to be served cold e.g. cream filled gateaux, cakes covered with icings or frostings, cheesecakes, biscuits, scones, etc.

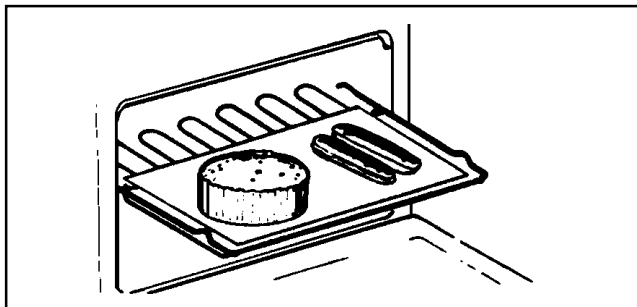

It is preferable to thaw fish, meat and poultry slowly in the fridge. However, this process can be accelerated by using the defrost function.

Small or thin fish fillets, frozen peeled prawns, cubed or minced meat, liver, thin chops, steaks etc., can be thawed in 1 - 2 hours.

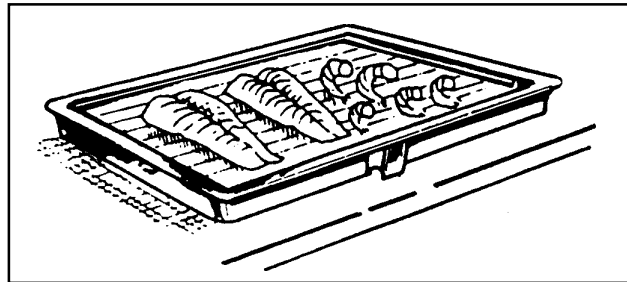

A 1kg/2¼lb oven ready chicken will be thawed in approximately 5 hours. Remove the giblets as soon as possible during the thawing process.

Joints of meat up to 2kg/4½lb in weight can be thawed using the defrost function.

ALL JOINTS OF MEAT AND POULTRY MUST BE THAWED THOROUGHLY BEFORE COOKING.

ALWAYS COOK THOROUGHLY IMMEDIATELY AFTER THAWING.

SELECTING DEFROST

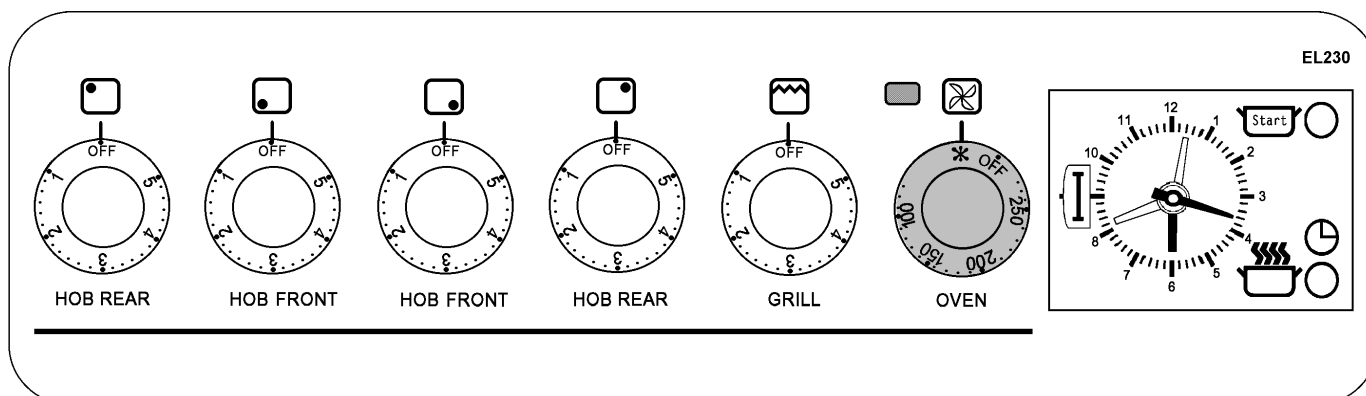

- Turn the oven temperature control clockwise from the off position to the defrost setting. *
- When defrost is selected, the oven indicator neon may come ON. It will stay on until the oven reaches room temperature and then go OFF.
- It may turn ON and OFF periodically during defrosting to maintain steady room temperature inside the oven.

THINGS TO NOTE

Care must always be taken when handling foods in the home. Always follow the basic rules of food hygiene to prevent bacterial and microbial growth and cross contamination when defrosting, preparing, cooking, cooling and freezing foods.

HINTS AND TIPS

- Place the frozen food in a single layer where possible and turn it over half way through the defrosting process.

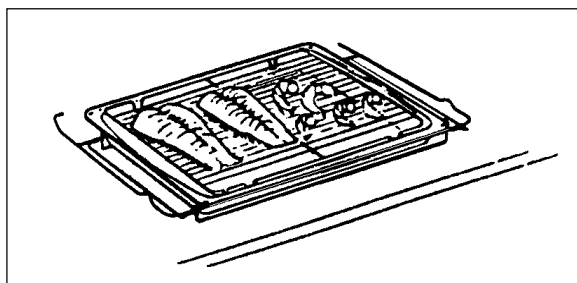

- The actual speed of defrosting is influenced by room temperature. On warm days defrosting will be faster than on cooler days.
- **DO NOT** leave food at room temperature once it is defrosted. Cook raw food immediately or store cooked food in the fridge.

CARE AND CLEANING

ALWAYS SWITCH OFF THE ELECTRICITY SUPPLY AT THE MAIN WALL SWITCH AND ALLOW THE COOKER TO COOL BEFORE CLEANING

CLEANING MATERIALS

Before using any cleaning materials on your cooker, check that they are suitable and that their use is recommended by the manufacturer.

CLEANING THE OUTSIDE OF THE COOKER

DO NOT use abrasive cleaning materials, or scourers on the outside of the cooker as some of the finishes are painted and damage may occur. Cleaners that contain bleach should NOT be used as they may dull the surface finishes. Regularly wipe over the splashback, hob, doors and cooker sides using a soft cloth and liquid detergent.

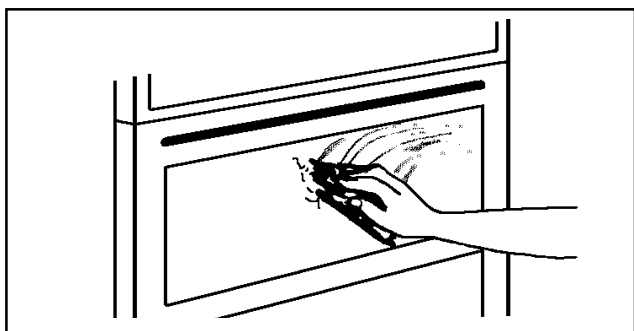

DO NOT ATTEMPT TO REMOVE ANY OF THE CONTROL KNOBS FROM THE PANEL AS THIS MAY CAUSE DAMAGE AND IS A SAFETY HAZARD.

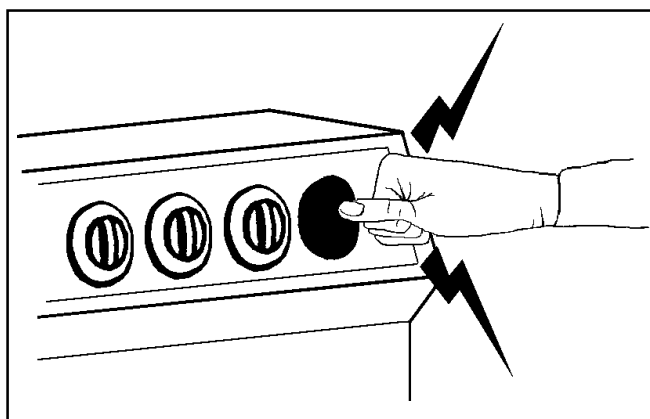

CLEANING THE HOB AND HOTPLATE TRIMS

Clean the hob surface with liquid detergent or a mild abrasive cream cleaner, e.g. Jif.

The chrome hotplate trims are removable for cleaning, and can be washed in the dishwasher. The hotplate supports should NOT be removed.

CLEANING THE GRILL DEFLECTOR, GRILL AND OVEN FURNITURE

All removable parts, with the exception of the grill pan handle can be washed in the dishwasher.

The grill pan, grill deflector and oven shelves can be cleaned using a soap impregnated steel wool pad. The grill pan grid should be cleaned using hot soapy water. Soaking first in soapy water will make cleaning easier.

CLEANING INSIDE THE OVEN AND GRILL COMPARTMENTS

The vitreous enamel in the grill compartment and the oven top and base can be cleaned using normal oven cleaners or aerosol oven cleaners with care.

Ensure that the manufacturers instructions are followed and that all parts are well rinsed afterwards.

Aerosol cleaners must not be used on the Stayclean back and sides and must not come into contact with elements as this may cause damage.

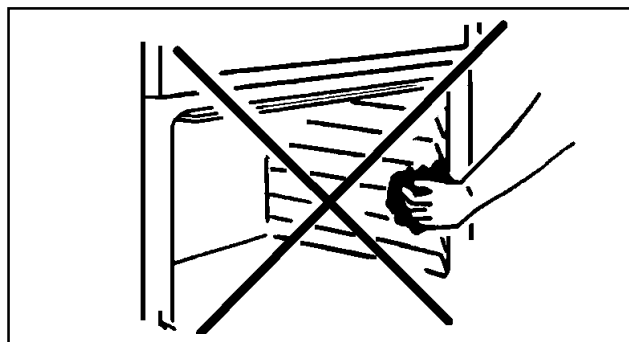

CARE OF STAYCLEAN SURFACES

The sides and back of the cooker are coated with a special finish to help make cleaning the oven easier.

The Stayclean surfaces destroy splashes of food and fats when the oven temperature is raised to around 220°C.

It is a good idea to run the oven for an hour or two per week without food to ensure continued good performance from the Stayclean finish.

THINGS TO NOTE

When operating the cooker at higher temperatures than used in normal cooking the surfaces of the cooker may get hotter than usual. Children should be kept away.

HINTS AND TIPS

- Manual cleaning of the Stayclean coating is not recommended. Damage will occur if abrasives or aerosol sprays of any kind are used.
- Slight discolouration and polishing of the Stayclean surfaces may occur in time. This does not affect the Stayclean properties in any way.
- A good time to allow the oven to run on is after the weekly roast. After removing the roast, turn the oven up to 220°C and allow to run for an hour or so. Some soilage will remain. It is important not to allow a build-up of soilage as this can prevent the Stayclean from working.
- Follow the recommendations below to keep oven soilage to a minimum.
- Cook at the recommended temperatures. Higher temperatures during roasting will increase soilage. Try cooking at lower temperatures for an increased length of time, you will save energy and often the joint is more tender.
- Use minimal, if any, extra oil or fat when roasting meat, potatoes only require brushing with fat before cooking. Extra fat in the oven during roasting will increase splashing and soilage.
- It is NOT necessary to add water to the meat tin when roasting. The water and the fat juices from the joint create excessive splattering during cooking - even at normal temperatures, as well as causing condensation.
- Covering joints during cooking will also prevent splashing onto the interior surfaces. Removing the covering for the last 20-30 minutes will allow extra browning if required. Some large joints and turkeys especially benefit by this method of cooking, allowing the joint to cook through before the outside is over-browned.

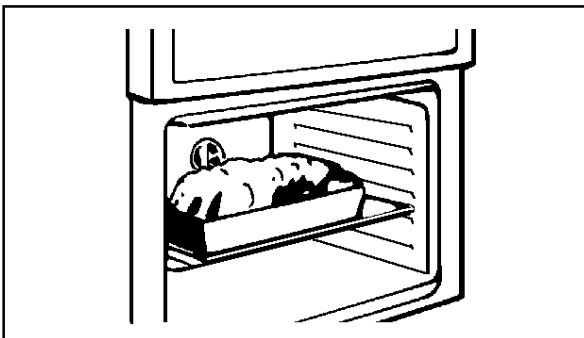

SOMETHING NOT WORKING

We strongly recommend that you carry out the following checks on your cooker before calling a Service Engineer. It may be that the problem is a simple one which you can solve yourself without the expense of a Service call.

If our Service Engineer finds that the problem is listed below you will be charged for the call whether or not the cooker is under guarantee.

The cooker does not work at all:

- * Check that the cooker has been wired in and is switched on at the wall.
- * Check that the timer is set for manual. See page 9.
- * Check that the main cooker fuse is working.

The oven temperature is too high or low:

- * Check that the recommended temperatures are being used (see pages 18 & 19). Be prepared to adjust up or down by 10°C to achieve the results you want.

The hotplates are slow to boil or simmer inadequately:

- * Check that the saucepans being used are suitable. See page 12.

The oven is not cooking evenly or the side opening door will not stay open:

- * Check that the cooker is level.
- * Check that the recommended temperatures are being used. See pages 18 & 19. Be prepared to adjust up or down by 10°C to achieve the results you want.

The timer does not work:

- * Check that the operating instructions are being followed, particularly when setting an automatic programme and returning the cooker to manual after automatic use. See page 9.

If the oven fan is noisy:

- * Check that the cooker is level.
- * Check that shelves and bakeware are not vibrating in contact with the back panel in the oven.

GUARANTEE

Your Electra cooker is covered by the terms of your Electricity Company's guarantee for the period of one year.

In the event of a defect please contact the Service Department of your local Electricity Company.

It is suggested that you record the model number, product number, serial number and date of purchase on the following page. The model, product and serial numbers of the cooker are detailed on the rating plate. This can be found on the lower front frame of the cooker upon opening the oven door.

IMPORTANT NOTICE

In line with our continuing policy of research and development, we reserve the right to alter models and specifications without prior notice.

This handbook is accurate at the date of printing, but may be superseded and should be disregarded if specifications or appearance are changed

SERVICE CALL RECORD

**How to obtain
After Sales Service
quickly**

Remember that you may be charged for a service call (even during the guarantee period) if nothing is found to be wrong with the cooker. So always check the instructions to make sure you have not missed anything.

Make a note of your nearest Electricity Company Service Depot and their telephone number here:

.....

The receptionist will need the answer to certain questions, so to save you time and money, please have the following information ready in case you have to call us.

Your name and address

.....

.....

Telephone number.....

Name of the cooker.....

Model number.....

The serial number (shown on the rating plate).....

Product number.....

The showroom where you bought the cooker.....

Date of purchase.....

If free service under guarantee is required, please have available proof of date of purchase when the Service Electrician calls.

In order to provide a complete service history of your cooker , please ask the Service Electrician to record the appropriate details in the chart below.

Date	Nature of Fault	Parts Replaced or Repaired	Signature

MODEL NO.
EL 230W/I



PART NO.
311212204

Free Manuals Download Website

<http://myh66.com>

<http://usermanuals.us>

<http://www.somanuals.com>

<http://www.4manuals.cc>

<http://www.manual-lib.com>

<http://www.404manual.com>

<http://www.luxmanual.com>

<http://aubethermostatmanual.com>

Golf course search by state

<http://golfingnear.com>

Email search by domain

<http://emailbydomain.com>

Auto manuals search

<http://auto.somanuals.com>

TV manuals search

<http://tv.somanuals.com>