

electra

MODERNE COOKER

MODEL EL 370

INSTALLATION AND USERS'

INSTRUCTIONS

PREFACE

Welcome to your new Electra cooker. Its stylish and practical design will enhance your kitchen and make "cooking electric" a pleasure.

Features include a radiant hob for responsive, economical cooking with two large and two small radiant rings, full width grill and fan assisted oven and three removable shelves.

Even if you have used an electric cooker before, it is important that you read these instructions thoroughly before starting to cook, paying particular attention to the installation and safety instructions.

Getting Help

If you have any problems with installing or operating your new cooker please contact your Electricity Company for advice.

For your own safety, make sure that these instructions on installation, use and maintenance are followed.

IMPORTANT

We advise you to keep these instructions in a safe place for future reference.

If you sell or transfer ownership of this product, please pass on these instructions to the new owner.

TECHNICAL DETAILS

MODEL NO.	EL 370
Voltage:	230/240 Volts AC 50Hz
Wattage:	9.9/10.8kW
Height:	900mm
Width:	500mm
Depth:	600mm

This appliance complies with: European Council Directive 73/23/EEC.
EMC Directive 89/336/EEC.
CE Marking Directive 93/68/EEC.

CONTENTS

Preface	1
Technical Details	2
Contents	3
Safety	5
Before Installation	5
During Operation	5
After Use	6
General	6
Introduction	7
Rating Plate	7
Installation	7
Reversible Main Oven Door	8
General Notes on Using Your Cooker	8
About Condensation and Steam	8
Oven/Grill Indicator Neons	8
Grill and Oven Furniture	8
Getting to Know Your Cooker	9
The Control Panel	9
The Electronic Minute Minder	10
The Ceramic Hob	12
Recommended Saucepans	12
Hints and Tips	12
Deep Fat Frying	13
Preserving	13
The Grill	14
Selecting the Grill	14
Things to Note	14
The Grill Pan and Handle	14
Hints and Tips	15
Grilling Chart	15
The Top Oven	16
Uses of the Top Oven	16
Selecting the Top Oven	16
Things to Note	16
To Fit the Top Oven Shelf	16
Hints and Tips	16
The Main Fan Oven	18
Selecting the Main Fan Oven	18
Things to Note	18
To Fit the Main Oven Shelves	19
Hints and Tips	19
Oven Cooking Chart	20
Roasting Chart	21

CONTENTS

Defrost Feature	22
Uses of Defrost Feature	22
Selecting Defrost	22
Things to Note	22
Hints and Tips	22
Care and Cleaning	23
Cleaning Materials	23
Cleaning the Ceramic Hob	23
Things To Note	23
Cleaning the Outside of the Cooker	24
Cleaning the Grill Pan, Grill Pan Grid and Oven Shelves	24
Cleaning Inside the Grill/Oven Compartments	24
Care of Stayclean Surfaces	25
Hints and Tips	25
Something not Working?	26
Guarantee	27
Service call record	28

SAFETY

THESE WARNINGS ARE PROVIDED IN THE INTERESTS OF YOUR SAFETY. ENSURE THAT YOU UNDERSTAND THEM ALL BEFORE INSTALLING OR USING THE COOKER.

PLEASE
READ
CAREFULLY



BEFORE INSTALLATION



This appliance is heavy and care **must** be taken when moving it.



Ensure that all packaging, both inside and outside the appliance, has been removed before the appliance is used.



Do not try to move the appliance by pulling the door handles.

The electrical installation work **must** be undertaken by a qualified electrician/competent person.



It is dangerous to alter or modify the specifications of the product in any way.

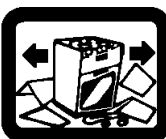

After installation, please dispose of the packaging with due regard to safety and the environment.

DURING OPERATION



Do not use this appliance if it is in contact with water. **Never** operate it with wet hands.



This appliance is designed to be operated by adults. Young children **MUST NOT** be allowed to tamper with the product or play with the controls.

Accessible parts especially around the grill area may become hot when the appliance is in use. Children should be **kept away** until it has cooled.



Take **great care** when heating fats and oils as they will ignite if they become too hot.

This product has been designed for cooking edible foodstuffs only, and **must not** be used for any other purposes.



Never place plastic or any other material which may melt in the oven or on the hob.



Ensure cooking utensils are large enough to contain foods to prevent spillages and boil overs.

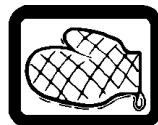

The handles of saucepans which are smaller than the heated area on the hob will become hot. **Ensure** your hand is protected before handling the pan.



Take care to follow the recommendations given for tending the food when grilling.



Do not leave the handle in position when grilling as it will become hot.

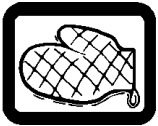

Always use oven gloves to remove and replace food in the oven. Similarly always use oven gloves to remove and replace the grill pan handle when grilling. Recommendations given on page 14.



Ensure that you support the grill pan when it is in the withdrawn or partially withdrawn position.

Ensure that all vents are left unobstructed to ensure ventilation of the oven cavity.

Ensure that the anti-tilt shelves are put in place correctly. Refer to instructions on pages 16 and 19.

Never line any part of the appliance with aluminium foil.



Always stand back from the appliance when opening the oven door to allow any build up of steam or heat to release.



Do not place sealed cans or aerosols inside the oven. They may explode if they are heated.

Do not leave the hotplates switched on for long periods when not covered by a saucepan. The controls and cabinets may overheat.

AFTER USE



Ensure that all control knobs are in the OFF position when not in use.



For hygiene and safety reasons this appliance should be kept clean at all times. A build-up of fats or other foodstuffs could result in a fire, especially in the grill pan.



Do not leave utensils containing foodstuffs, e.g. fat or oil in or on the appliance in case it is inadvertently switched ON.

Cookers and hobs become **very hot**, and retain their heat for a long period of time after use. Children should be kept well away from the appliance until it has cooled.

GENERAL



Under no circumstances should repairs be carried out by inexperienced persons as this may cause injury or serious malfunction. This product should be serviced by an authorised Service Engineer and only genuine approved spare parts should be used. Details of servicing and repair arrangements are given on page 28 of this book.



Do not stand on the appliance or on the open oven door.



Do not hang towels, dishcloths or clothes from the appliance or its handles. They are a safety hazard.



Only clean this appliance in accordance with the instructions given in this book.

Your safety is of paramount importance.

Therefore, if you are unsure about any of the meanings of these WARNINGS contact your local Electricity Company.

INTRODUCTION

WARNING: THIS APPLIANCE MUST BE EARTHED

RATING PLATE

Record the model, product and serial numbers on the back cover of this instruction book, from the rating plate. This is situated on the lower front frame of the appliance and can be seen upon opening the oven door.

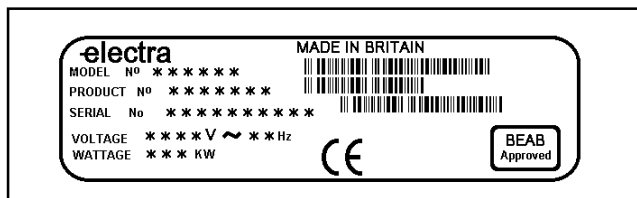

The appliance must be protected by a suitably rated fuse or circuit breaker. The rating of the appliance is given on the rating plate.

INSTALLATION

If your cooker has been damaged in transit, contact your supplier immediately. **DO NOT** attempt to install it.

Your cooker left the factory fully packaged to protect it from damage. If it is delivered without packaging and damage has occurred, the manufacturer cannot accept responsibility. Contact your supplier for advice.

Once the packaging has been removed the cooker should only be moved by hand. **DO NOT** use a sack barrow or any other aid to lift the cooker as damage may occur.

Connection to the electricity supply must be carried out by a qualified electrician/competent person.

The electrical connection should be made using a double pole isolating switch (cooker socket) with at least 3mm contact separation. The cable must have conductors of sufficiently high cross-sectional area to prevent overheating and deterioration.

Six square millimetres (6.00mm²) is the recommended cross-section area.

The cable should be routed away from potentially hot areas marked by X in the diagram below.

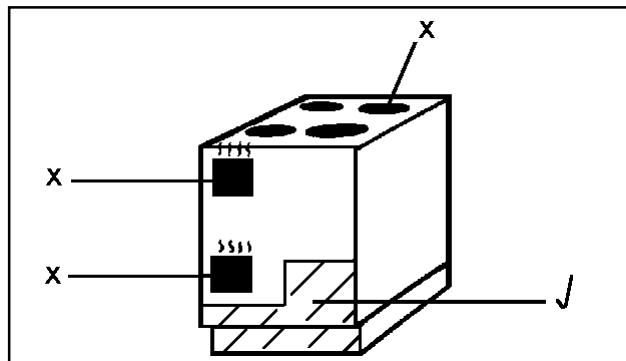

To move the cooker, open the main oven door and lift the cooker by holding inside the top of the compartment.

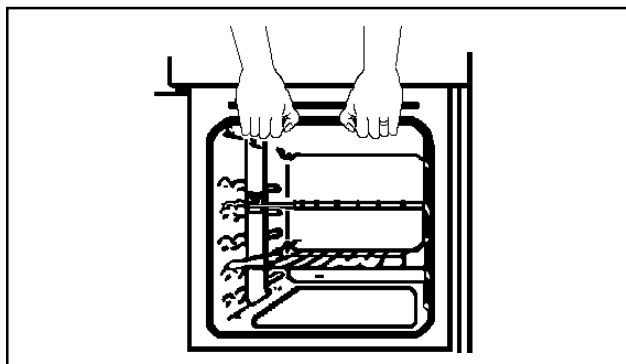

This is a type X appliance which means it is free-standing and can be fitted with cabinets on one or both sides. It may also be fitted in a corner setting.

Side walls which are above hob level should be protected by heat resistant non-combustible material and **MUST NOT** be nearer than 40mm to the hob side.

A nominal air gap of 2mm at either side of the cooker is required to enable the cooker to be moved into position. It is recommended that proprietary trims are fitted to protect the worktops of either side of the appliance. These are available from most DIY stores.

Two spacers have been incorporated into the back of the appliance to ensure an air gap of 10mm is maintained at hotplate level. Tiles or other forms of deep wall covering should not obscure this gap.

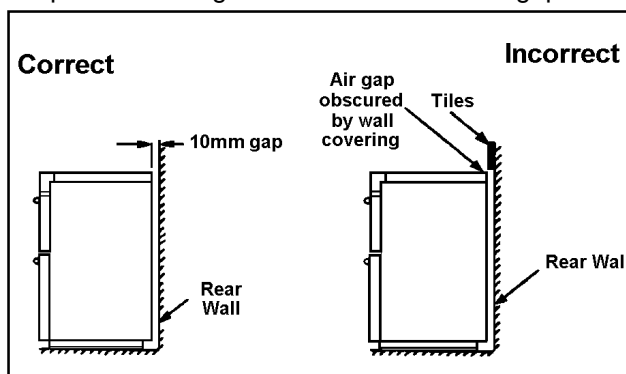

Overhanging surfaces or a cooker hood should be a minimum of 685mm above the hob.

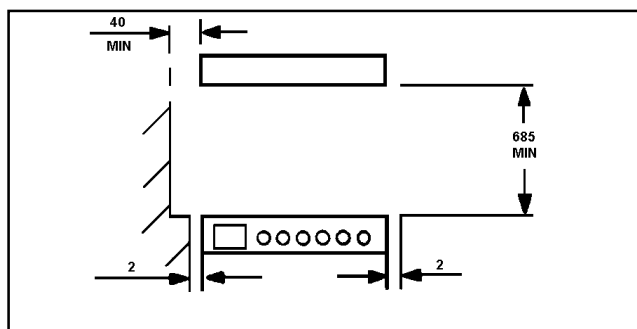

It is important to ensure that the appliance is level after installation. Levelling feet are fitted to the front of the appliance to accommodate uneven floors.

REVERSIBLE MAIN OVEN DOOR

If you require the oven door to be hinged on the opposite side, you will need to contact your local Electricity Company's Service Department. PLEASE NOTE that a charge may be made.

GENERAL NOTES ON USING YOUR COOKER

We suggest that you run all the elements for a short period to burn off any residue from their surfaces.

To do this, run the ovens at 220°C for approximately 45 minutes. The procedure should be repeated with the grill for approximately 5 - 10 minutes.

During this period an unpleasant odour may be emitted, it is therefore advisable to open a window for ventilation.

ABOUT CONDENSATION AND STEAM

When food is heated it produces steam similar to a boiling kettle. The ovens are vented to allow some of this steam to escape between the wall and the rear of the appliance. However, always stand back from the appliance when opening the oven door to allow any build up of steam or heat to release.

If the steam comes into contact with a cool surface on the outside of the appliance, e.g. a trim, it will condense and produce water droplets. This is quite normal and is not caused by a fault on the appliance.

To prevent discolouration, regularly wipe away condensation and also soilage from surfaces.

For your safety, wall coverings at the rear of the appliance should be securely fixed to the wall.

OVEN / GRILL INDICATOR NEONS

These lights indicate whether the ovens or grill are switched on. In the case of the ovens, they also indicate when the set temperature has been reached. They will cycle on and off during use to show that the temperature is being maintained. The grill neon may cycle when the grill is switched on.

THE COOLING FAN FOR THE CONTROLS

The cooling fan will always come on when the grill and the top oven are switched on. If they are only used for a short period of time the fan will switch off when the controls are turned off. If the grill or the top oven are used for a longer period of time the fan will run on depending on the temperature, and may cycle on and off until the cooker has cooled.

In the case of the main oven the cooling fan may not switch on except when used for a longer period of time. The cooling fan may run on, and cycle on and off after the control knobs have been switched off, until the cooker has cooled. Do not switch the cooker off at its power point until the fan has cooled the cooker down.

GRILL AND OVEN FURNITURE

The following items of oven furniture have been supplied with the cooker:

1 grill pan



1 grill pan handle

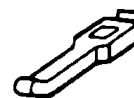

1 grill pan grid

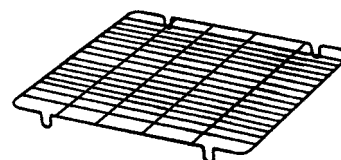

1 grill deflector



1 cranked shelf for grilling and top oven cooking only

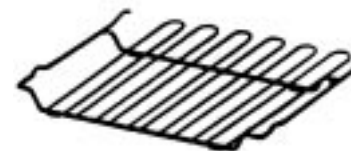

2 straight shelves for main oven cooking

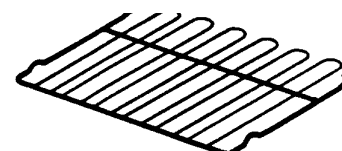

GETTING TO KNOW YOUR COOKER

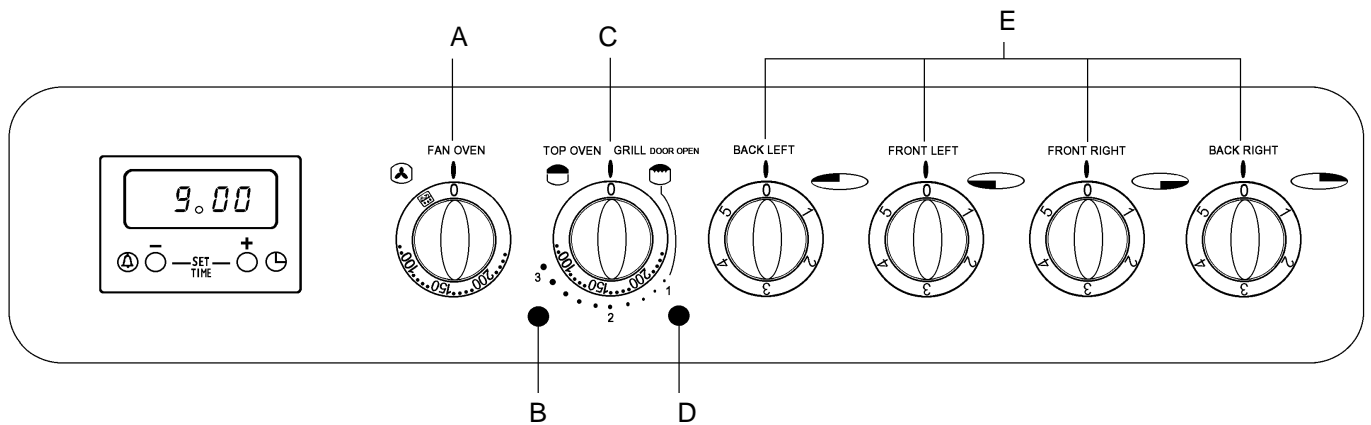

THE CONTROL PANEL



FEATURES

- A - Main Oven Temperature Control
- B - Main Oven Indicator Neon
- C - Top Oven/Grill Control
- D - Top Oven/Grill Indicator Neon
- E - Hotplate Controls

ELECTRONIC MINUTE MINDER

- 1 = (-) DECREASE CONTROL & MINUTE MINDER SETTING BUTTON
- 2 = (+) INCREASE CONTROL
- () COOKPOT SYMBOL
- () CLOCK SETTING SYMBOL
- () MINUTE MINDER SYMBOL

The electronic minute minder can indicate the time of day, operate as a minute minder and it can be used to time and switch off the main oven.

1. SET THE TIME OF DAY

When the electricity supply is first switched ON, the display will flash 0.00. See Fig. 1.

Press buttons (1) and (2) together. The display will momentarily read 88.88. See Fig. 2. Release buttons, 0.00 will appear in the display as Fig. 3. **Within 5 seconds** press button 2, 12.00 will show in the display as Fig. 4.

Within 5 seconds press and hold either button (1) to decrease or button (2) to increase the time until the correct time of day on the 24 hour clock is reached, e.g. 14.30. See Fig. 5.

Note: The increase and decrease control buttons operate slowly at first, and then more rapidly. They should be pressed separately.

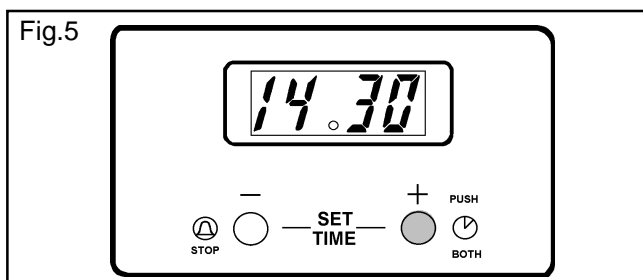
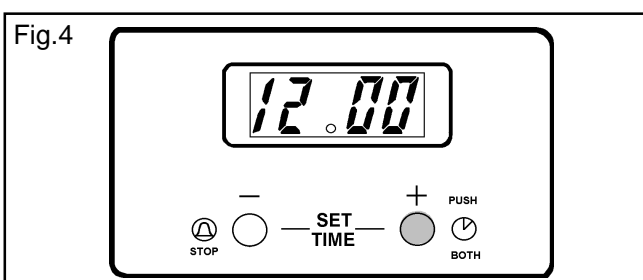
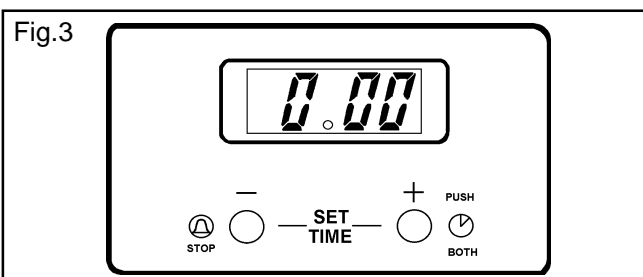
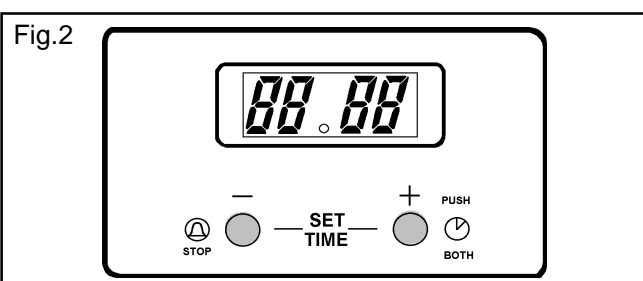
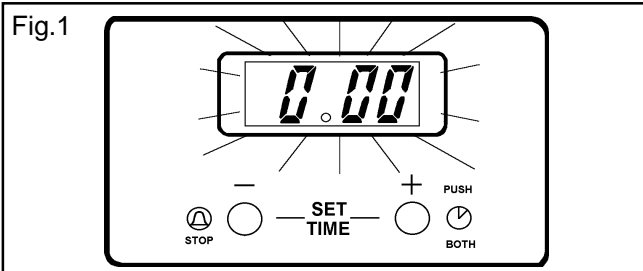
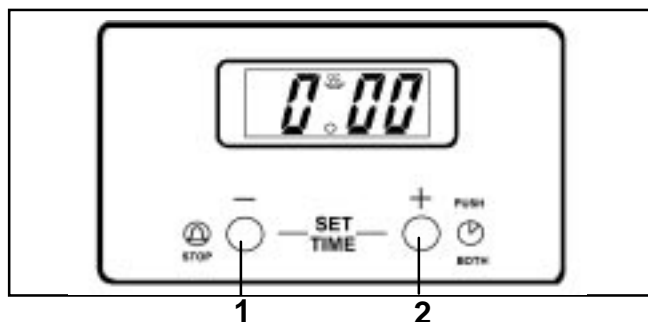

2. THE MINUTE MINDER

IMPORTANT

The minute minder can be used to time a set cooking period. At the end of the cook time the minute minder will automatically switch off the main oven if in use.

The minute minder gives an audible reminder at the end of any period of cooking up to 23 hours and 59 minutes.

To set press button (1) and the display will read 0.00, see Fig. 6.

Release button (1) and press and hold button (2). The display will count up in one minute intervals until the interval to be timed is reached e.g. 30 minutes, see Fig. 7. If necessary press and hold button (1) to achieve the correct time interval.

The minute minder will begin to count down once set. At the end of the timed period the minute minder will click, switching the main oven OFF if in use.

An audible signal will sound for up to 2 minutes. The second oven, if in use will remain ON. The cookpot symbol will flash and the time of day will show in the display. See Fig. 8.

To stop the sound press button (1). The display will stop flashing and show the time of day, e.g. 15.00. The cookpot symbol () will go out, see Fig. 9. If using the main oven it will come on again once button (1) has been depressed. The second oven will remain on. When cooking is complete remove food and turn OFF oven temperature control.

3. TO CANCEL THE MINUTE MINDER

Press and release button (1). Press and hold button 1 and the display will count down in one minute intervals to 0.00 See Fig 10. Release button (1). After a few seconds the cookpot symbol will flash and the time of day will show in the display. See Fig. 11.

If the main oven is in use this will switch OFF after a few seconds. The second oven if in use will remain ON.

To reset, press buttons (1) and (2) together. See Fig. 12.

4. THINGS TO NOTE

1. The time of day must be set before the main oven will operate. There will be a few seconds delay before the oven switches on.
2. The minute minder function controls the main oven only and will switch the oven OFF at the end of a timed period. This function is useful if you want to begin cooking now and have the oven switch OFF automatically.
3. If you have used the minute minder to time food cooking in the main oven you will need to reset the timer by pushing both buttons before the oven can operate again.

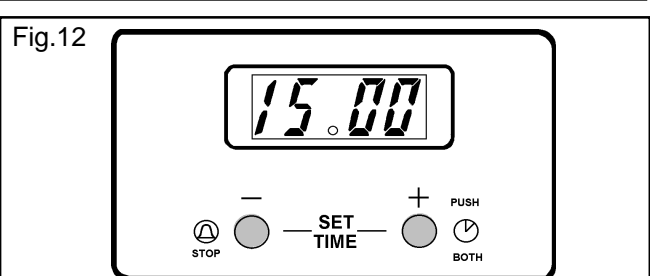
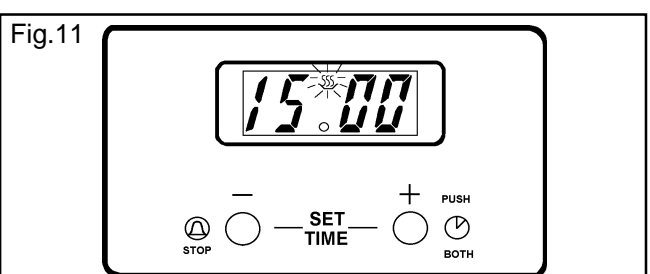
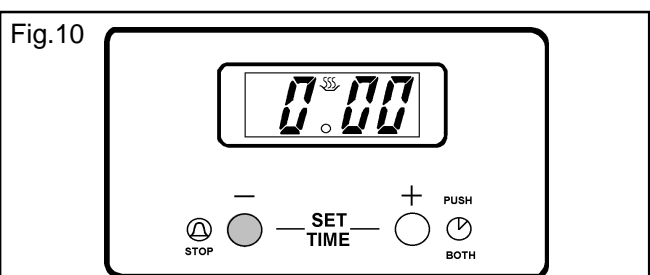
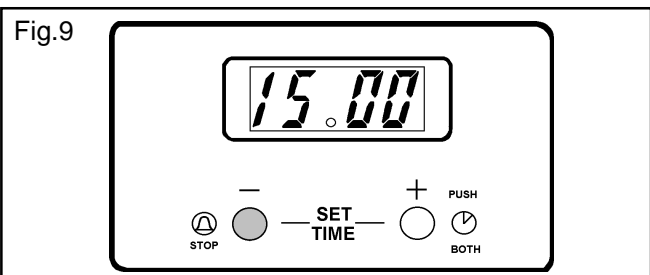
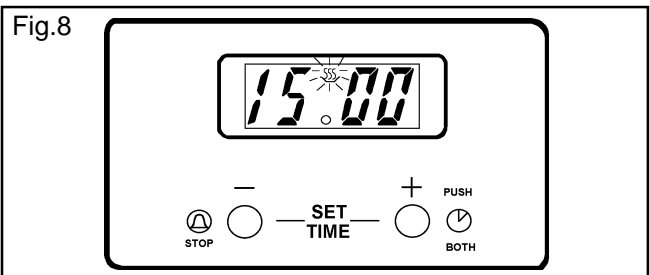
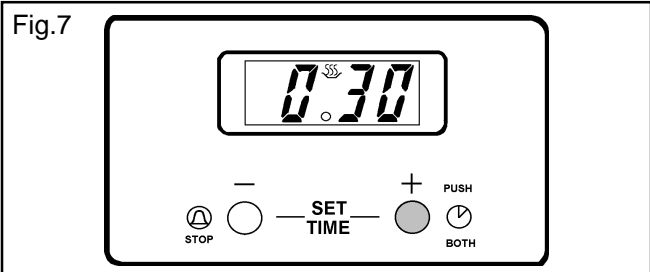
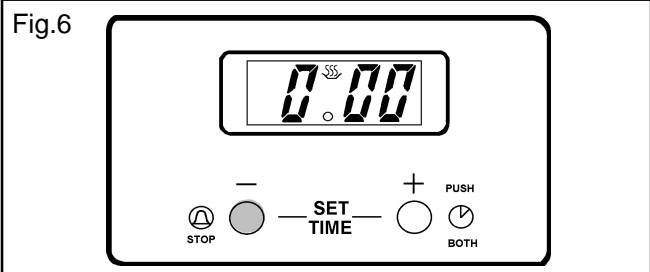

THE CERAMIC HOB

CAUTION: DO NOT USE THE COOKER IF THE CERAMIC GLASS IS DAMAGED. IF A FAULT OR CRACK BECOMES VISIBLE DURING COOKING, DISCONNECT THE COOKER IMMEDIATELY FROM THE ELECTRICITY SUPPLY AND CONTACT THE SERVICE DEPARTMENT OF YOUR LOCAL ELECTRICITY COMPANY.

USING THE HOB

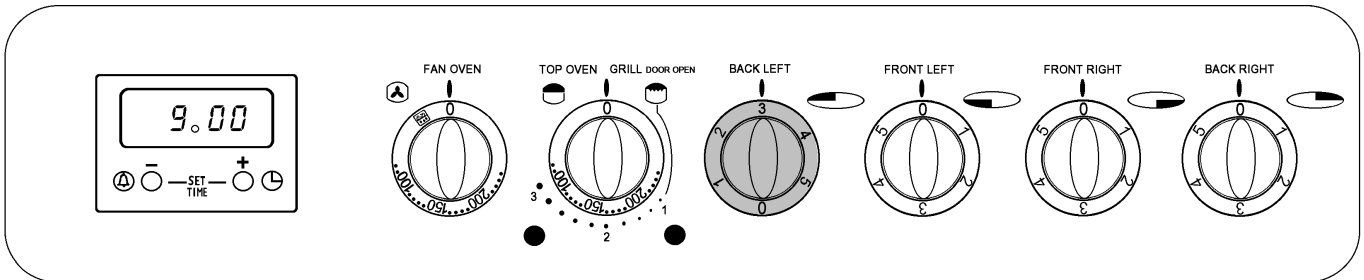

- For single hotplates, turn the control knob in either direction to vary the heat setting. The highest number represents the hottest setting and the lowest the coolest setting. Choose a setting appropriate to the quantity and type of food to be cooked.

RECOMMENDED SAUCEPANS

For speed and economy only good quality saucepans with flat bases and close fitting lids are recommended. The saucepan base should be approximately the same size as the cooking area, a base diameter of up to 225mm (9") may be used on a 180mm (7") heated area.

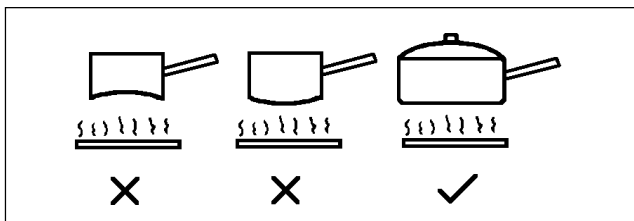

Ensure that new saucepans are well scrubbed to remove edges and take off any deposits left from manufacture.

Pressure cookers, preserving pans etc., should comply with the recommendations given above.

Traditional round bottomed Woks must not be used even with a stand. Woks with flat bottomed-bases are available and do comply with the above recommendations.

NOTE

Occasionally the heated areas may be seen to switch ON and OFF when higher heat settings are being used. This is due to a safety device which prevents the glass from overheating. Some switching ON and OFF when cooking at high temperatures, e.g. deep fat frying is quite normal, causes no damage to the hob and little delay in cooking times.

Excessive switching may however be caused by the use of an unsuitable saucepan or a saucepan which is smaller than the heated area. If excessive switching occurs, discontinue use of the saucepan.

HINTS AND TIPS

- Lift, rather than slide saucepans on and off the heated areas, This will reduce the risk of scratches and metal marks from saucepans with aluminium bases. Metal marks can be easily cleaned off providing they are not allowed to burn on.

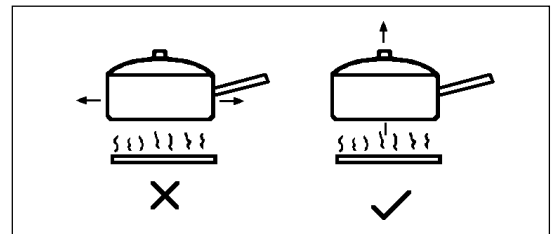

- Follow any guidelines provided by the saucepan manufacturer, particularly those relating to recommended heat settings.
- Avoid using thin, badly dented or distorted saucepans as they can lead to sticking and burning of food.

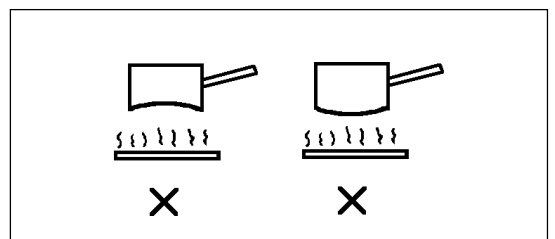

- To prolong the life of the hotplates:-
 - DO NOT place aluminium foil and plastic vessels on the hot surface of the ceramic hob and DO NOT use the surface for storage purposes.

- Never use utensils with a skirt, e.g. a bucket.
- Never use an asbestos mat.
- Never leave the hotplates ON when not covered with a saucepan.
- Ensure that hob and saucepans are clean and dry before the start of cooking to reduce cleaning.
- Follow the cleaning instructions very closely to keep the hob looking like new.
- **If spillage occurs with sugar solutions, e.g. jams and syrups, it must be wiped from the hob before it sets and becomes hard otherwise damage to the hob will occur.**

DEEP FAT FRYING

SPECIAL FRYING NOTE:

For safety purposes when deep fat frying, fill the pan one-third full of oil, DO NOT cover the pan with a lid and DO NOT leave the pan unattended. In the unfortunate event of a fire, switch OFF at the electricity supply and cover the pan with a lid or damp cloth to assist in smothering the flames.

DO NOT use water on the fire. Leave the pan to cool for at least 30 minutes before moving it.

DO NOT leave the fat or oil in the frying pan on the hob to store it in case the hob is inadvertently switched ON.

1. Preparing the food

Seal the food by coating with flour, egg and breadcrumbs or batter. **Do not** use a basket with batter coated foods as they will stick.

2. Amount of oil

For safety purposes fill the pan only one-third full of oil.

3. Testing the temperature of the oil

It is advisable to use a thermometer to test the temperature of the oil. Alternatively, drop a small cube of bread into the oil which should brown in just under a minute if the oil is at the correct temperature of 190°C/375°F.

4. Cooking the food

Lower the food gently into the oil. **Do not** add too much food at once or the temperature of the oil will be reduced and may result in soggy, greasy food.

Turn the food if necessary; doughnuts float to the surface so will not brown on the upperside if not turned. Once cooked, drain the food on absorbent paper.

5. Double frying chips

Double frying will ensure good chips. First fry the chips for a few minutes at 170°C/340°F to seal the outside. Remove the chips from the oil. Increase the temperature of the oil to 190°C/375°F to finish cooking and brown the chips.

Chips may be kept for several hours after the first frying before finishing off with the second frying.

6. Frying temperatures

	Celsius Scale (°C)	Fahrenheit Scale (°F)
	150	300
First frying of potatoes	170	340
	175	350
	180	360
Second frying of potatoes	190	375
Frying chicken and fish	195	380
	200	390

PRESERVING

1. DO NOT use a pan that overlaps the perimeter of the hob trim.

2. To allow for a full rolling boil, the pan should be no more than one third full when all the ingredients have been added. It is better to use two pans rather than overfill one, or use half quantities.

3. Use firm fruit or vegetables and wash well before using.

4. Preserving sugar gives clear jam, however granulated sugar is cheaper and gives equally good flavour.

5. Crystallization may be caused if sugar is not completely dissolved before bringing jam to the boil. Over boiling will affect the flavour, setting properties and colour of the jam.

6. To test jam for setting:

If a jam thermometer is available, boil jam to 104°C. Marmalade should be boiled to 106°C.

If a jam thermometer is not available, remove pan from heat, place sample of jam on a cold dish and cool quickly (i.e. in a freezer or frozen food storage compartment of a refrigerator). When cold, it will crinkle and hold the mark of a finger run through it, if it is ready.

7. The scum should be removed as soon as possible after setting, but marmalade should be allowed to cool before potting to prevent the peel rising.

THE GRILL

CAUTION - ACCESSIBLE PARTS MAY BECOME HOT WHEN THE GRILL IS IN USE. CHILDREN SHOULD BE KEPT AWAY.

SELECTING THE GRILL

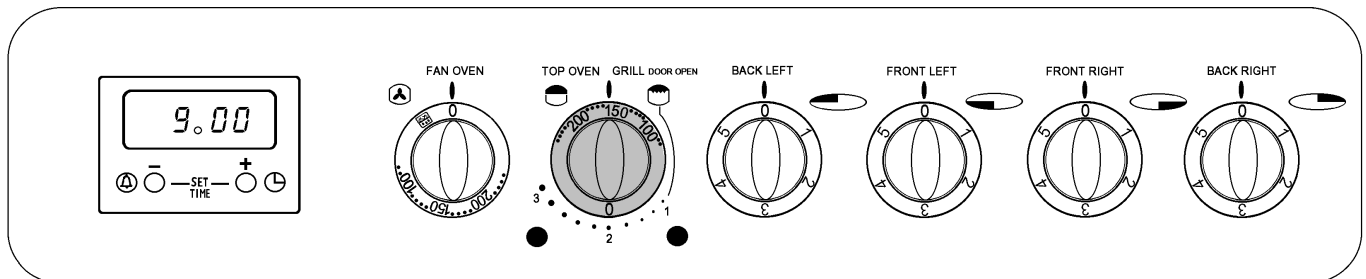

- To operate the grill open the grill door and turn the top oven/grill control clockwise so that '0' on the control knob lines up with setting 1, 2 or 3.
- Setting 3 represents the grill on Full. At settings 1 and 2 the grill may cycle on and off over time and you may prefer to use these settings for keeping food warm.
- The grill neon will illuminate. It may cycle on and off during cooking.

THINGS TO NOTE

THE GRILL DOOR MUST BE LEFT FULLY OPEN DURING GRILLING. IF THE DOOR IS CLOSED THE TOP OVEN WILL OPERATE.

If the grill door is accidentally closed during grilling, the grill will cut out and the top oven will operate.

The cranked shelf **MUST** only be used in the grill compartment, but a straight shelf from the main oven may be used to provide alternative positions.

Some smoke from fat splashes may be evident as the grill element cleans itself.

The top oven **cannot** be operated when the grill is in use.

Only the inner element will operate when grilling.

THE GRILL PAN AND HANDLE

The grill pan is supplied with a removable handle.

To insert the handle, press the button on the handle with the thumb and pivot the handle slightly upwards inserting the lip into widest part of the bracket. Move the handle towards the left, lower into position and release the button.

Ensure the handle is positively located.

When removing the handle, press the button on the handle with the thumb and pivot the handle slightly upwards and towards the right to remove from the bracket.

Ensure your hand is protected when inserting and removing the grill pan handle as the control panel trim and grill element can become very hot.

ALWAYS REMOVE THE GRILL PAN HANDLE DURING GRILLING.

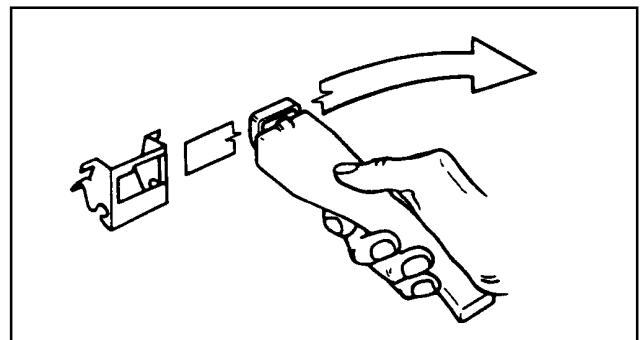

To correctly locate the grill pan on the shelf, ensure that the cut out on the underside of the handle bracket locates over the front bar of the shelf.

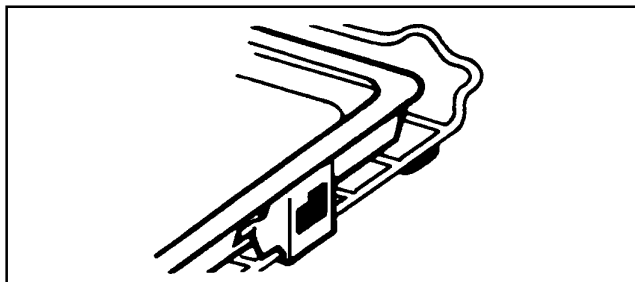

To check the progress of the food being grilled, the grill pan should be withdrawn on the shelf to tend the food during cooking, or the carrier shelf can be lifted away from the cooker and rested on a heat resistant work surface.

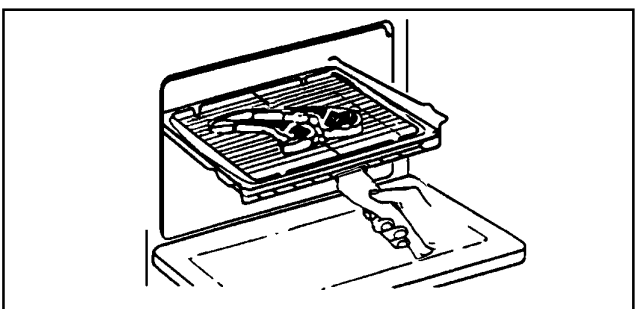

HINTS AND TIPS

- Food should be thoroughly dried before grilling to minimise splashing. Brush lean meats and fish lightly with a little oil or melted butter to keep them moist during cooking.
- Adjust the grid and grill pan runner position to allow for different heights of food.

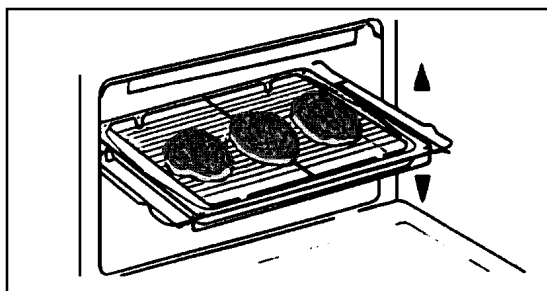

- Place food on the grill pan grid or directly onto the grill pan base.

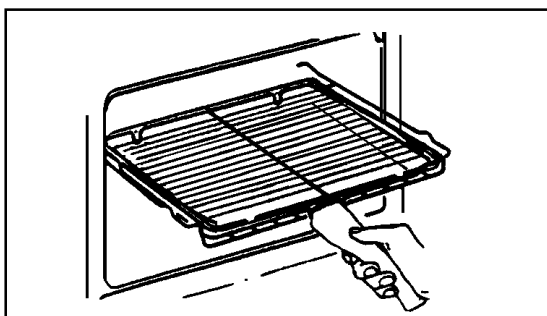

- Accompaniments such as tomatoes and mushrooms may be placed around the outer edges or underneath the grid when grilling meats.

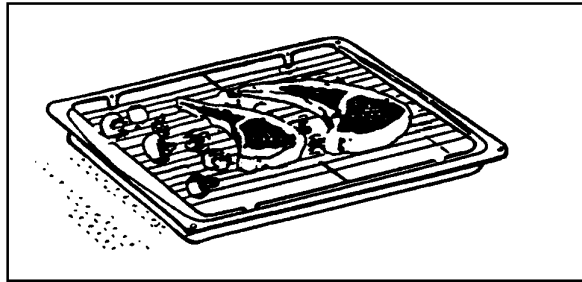

- When toasting bread use the shelf in position 2 with the grid in the high position and placing the bread in the centre of the grid.
- Preheat the grill on a full setting for five minutes before cooking. Adjust the shelf as necessary during cooking.
- The food should be turned over during cooking as required.

GRILLING CHART

FOOD	SHELF	GRILL TIME (mins)
Bacon Rashers	2 crk.	2-3 each side
Beefburgers	2 crk.	6-10 each side
Chicken Joints	2 crk.	15-20 each side
Chops - Lamb	2 crk.	7-10 each side
Pork	2 crk.	10-15 each side
Fish - Whole Trout/Mackerel	2 crk.	8-12 each side
Fillets - Plaice/Cod	2 crk.	4-6 each side
Kebabs	2 crk.	10-15 each side
Kidneys - Lamb/Pig	2 crk.	4-6 each side
Liver - Lamb/Pig	2 crk.	5-10 each side
Sausages	2 crk.	10-15 each side
Steaks - Rare	2 crk.	3-6 each side
Medium	2 crk.	6-8 each side
Well Done	2 crk.	7-10 each side
Toasted Sandwiches	2 crk.	1¼-1½ each side

crk. = cranked shelf

Shelf positions are counted from the bottom upwards.

The times quoted above are given as a guide and should be adjusted to suit personal taste.

THE TOP OVEN

USES OF THE TOP OVEN

The top oven is the smaller of the two ovens. It is heated by elements in the top and bottom of the oven. It is designed for cooking on one level and for smaller quantities of food. It gives especially good results if used to cook fruit cakes, sweet or savoury flans or quiche.

The top oven is also ideal for use as a warming compartment to warm dishes and keep food hot. Use a temperature setting of 90-100°C on the top oven control dial.

SELECTING THE TOP OVEN

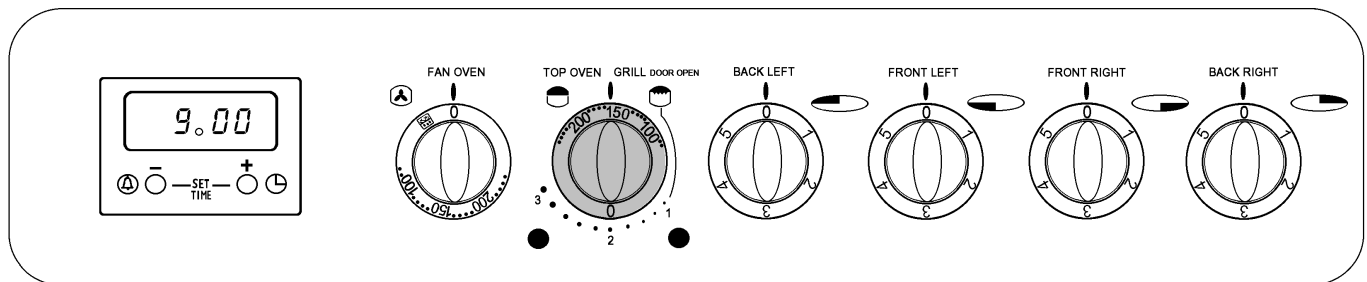

- Turn the top oven temperature control to the required setting. Our diagram shows the oven set to 150°C. Close the oven door.

THINGS TO NOTE

1. The grill cannot be operated when the top oven is in use. Only the outer part of the top oven element in conjunction with the base element will operate when using the top oven.
2. The top oven indicator neon will glow until the oven has reached the desired temperature and then go out. It will then cycle ON and OFF showing that the oven temperature is being maintained.
3. Always place plates on the oven shelf to warm. Never place directly on the top oven base as it becomes very hot and damage may occur.

TO FIT THE TOP OVEN SHELF

The cranked shelf must only be used in the top oven compartment.

The shelf should be fitted with the straight rods uppermost on the frame and the forms towards the back of the oven. If not fitted correctly the anti-tilt and safety stop mechanism will be affected.

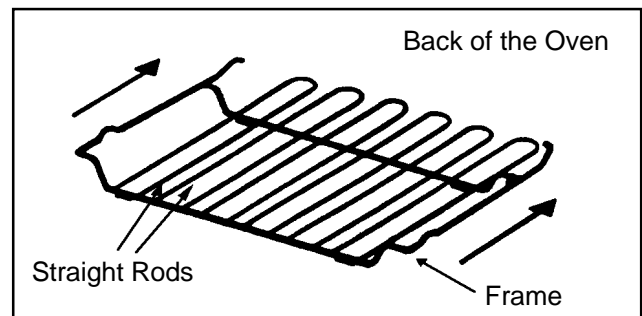

HINTS AND TIPS

- All cooking should be carried out using an oven shelf positioned in one of the shelf runners.

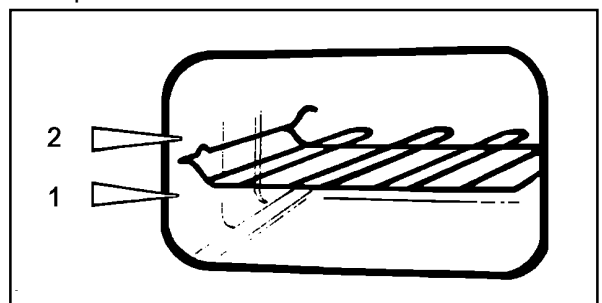

- Stand dishes on a suitably sized baking tray on the shelf to prevent spillage onto the oven base and to help reduce cleaning.

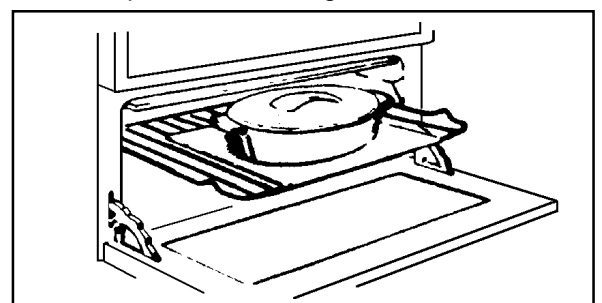

- There should always be at least 2.5cm (1") between the top of the food and the element. This gives best cooking results and allows room for rise in yeast mixtures, Yorkshire puddings, etc.
- When cooking cakes, pastry, scones, bread, etc., place the tins or baking trays centrally on the shelf directly below the element.

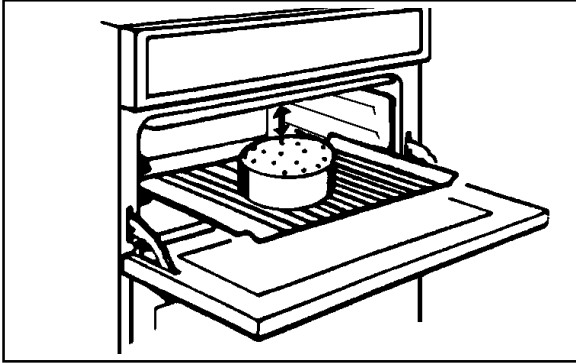

- DO NOT place dishes directly onto the oven base as it becomes very hot and damage may occur.

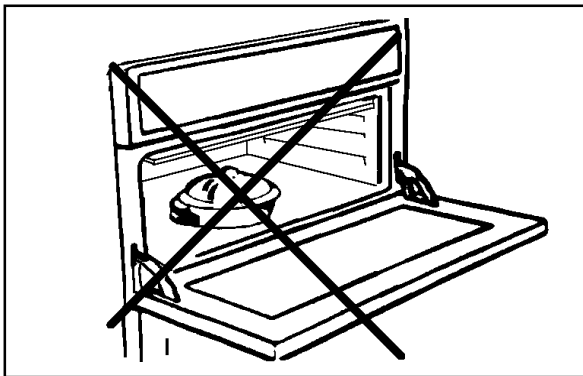

- The material and finish of the baking trays and dishes will affect the degree of base browning of the food. Enamelware, dark, heavy or non-stick utensils increase base browning. Shiny aluminium or polished steel trays reflect the heat away and give less base browning.
- DO NOT use the grill pan as a baking tray as this will increase base browning of the food.
- Because of the smaller cooking space, lower temperatures and shorter cooking times are sometimes required. Be guided by the recommendations on page 20.

- For economy leave the door open for the shortest possible time, particularly when placing food into a pre-heated oven.

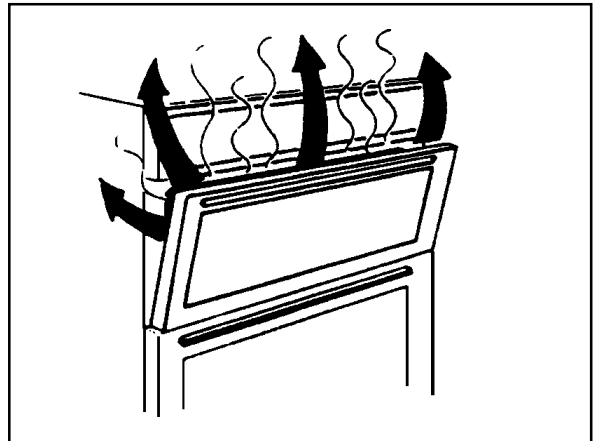

THE MAIN FAN OVEN

USES OF THE FAN OVEN

PREHEATING

The fan oven quickly reaches its temperature, so it is not usually necessary to preheat the oven. Without preheating, however, you may find you need to add an extra 5 - 10 minutes on the recommended cooking times. For recipes needing high temperatures, e.g. bread, pastries, scones, soufflés, etc., best results are achieved if the oven is preheated first.

COOKING TEMPERATURES

Fan oven cooking generally requires lower temperatures than conventional cooking. Follow the temperatures recommended in the chart on page 20. As a guide reduce temperatures by about 20°C - 25°C for your own recipes.

BATCH BAKING

The fan oven cooks evenly on both shelf levels, especially useful when batch baking.

SELECTING THE FAN OVEN

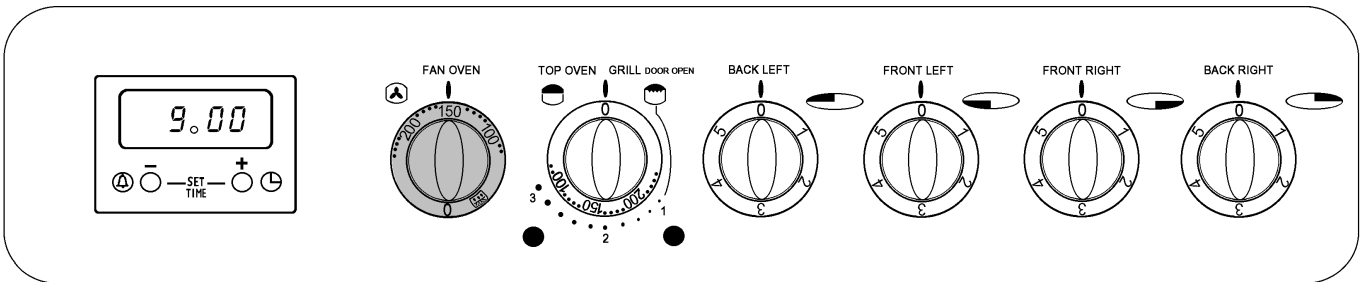

- Turn the main oven temperature control to the required setting.

THINGS TO NOTE

1. The main oven indicator neon will glow until the oven has reached the required temperature and then go out. It will cycle ON and OFF periodically during cooking showing that the temperature is being maintained.
2. The cooling fan for the controls may switch in after a time. See page 8 for more information on the operation of the cooling fan.

TO FIT THE MAIN OVEN SHELVES

The shelves should be fitted with the straight rods uppermost on the frame and the forms towards the back of the oven. If not fitted correctly the anti-tilt and safety stop mechanism will be affected.

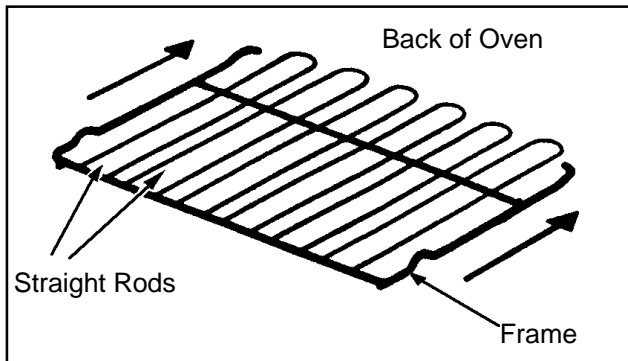

HINTS AND TIPS

- Arrange the shelves in the required positions before switching the oven ON. Shelves are numbered from the bottom upwards.

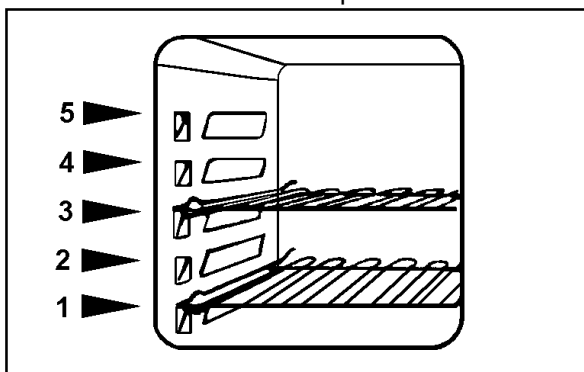

- When cooking more than one dish in the fan oven, place dishes centrally on different shelves rather than cluster several dishes on one shelf. This will allow the heat to circulate freely for the best cooking results.
- When batch baking one type of food, e.g. Victoria sandwich cakes, those of similar size will be cooked in the same time.

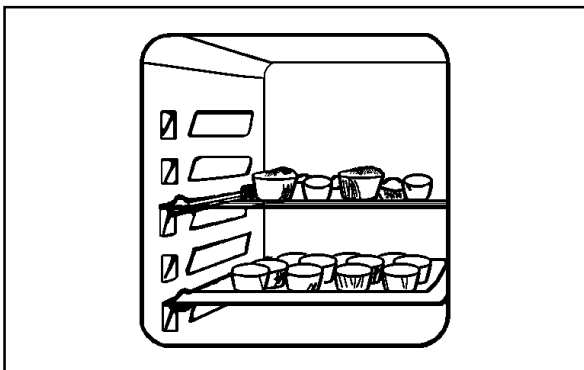

- It is recommended that when baking larger quantities, the shelf positions should be evenly spaced to suit the load being cooked. A slight increase in cooking time may be necessary.
- Do not place dishes or baking trays directly on the oven floor as it interferes with the oven air circulation and can lead to base burning; use the lower shelf position. However non critical dishes can be placed on the oven base when more space is required.

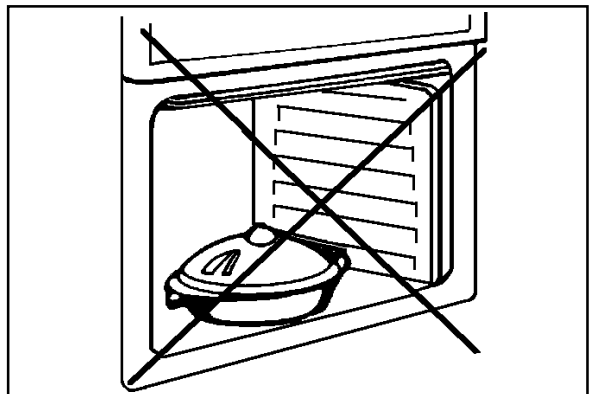

- The use of excessively high temperatures can cause uneven browning. It may be necessary to reduce temperatures slightly. Refer to the recommendations given in the oven cooking chart on page 20.
- Do not use the cranked shelf from the grill in the main oven.

OVEN COOKING CHART

The oven temperatures are intended as a guide only. It may be necessary to increase or decrease the temperatures by 10°C to suit individual preferences and requirements.

FOOD	FAN OVEN		TOP OVEN		
	SHELF POSITION	COOKING TEMP (°C)	SHELF POSITION	COOKING TEMP (°C)	APPROX COOK TIME (m)
Biscuits		180-190	1 crk	170-190	10-20
Bread		200-220	1 crk*	200-220	25-30
Bread rolls/buns	Shelf	200-220	1 crk	200-220	15-20
Cakes: Small & Queen		160-170	1 crk	180-190	18-25
Sponges		160-170	1 crk	160-170	18-20
Victoria Sandwich	positions	160-170	1 crk	160-170	18-25
Madeira		140-150	1 crk	140-150	1¼-1½h
Rich fruit		130-140	1 crk	140-150	2¼-2½h
Christmas	are not	130-140	1 crk	130-140	3-4½h
					depends on size
Gingerbread		140-150	1 crk	140-150	1¼-1½h
Meringues	critical	80-100	1 crk	90-100	2½-3h
Flapjack		170-180	1 crk	170-180	25-30
Shortbread		130-140	1 crk	140-150	45-65
Casseroles Beef/Lamb	but ensure	140-160	1 crk*	140-160	2½-3h
Chicken		180-190	1 crk*	180-190	1¼-1½h
Convenience Foods		Follow manufacturer's instructions			
Fish	that oven	170-190	1 crk	170-190	20-30
Fish Pie (potato topped)		190-200	1 crk*	190-200	20-25
Fruit Pies, Crumbles		190-200	1 crk	190-200	40-50
Milk Puddings	shelves are	130-140	1 crk	140-150	1½-2h
Pasta, Lasagne, etc.		190-200	1 crk	170-180	40-45
Pastry: Choux		190-200	1 crk	180-190	30-35
Eclairs, Profiteroles	evenly	170-180	1 crk	170-180	20-30
Flaky/Puff Pies		210-220	1 crk*	210-220	25-40
Shortcrust- Mince Pies		190-200	1 crk	190-200	15-20
Meat Pies	spaced	190-210	1 crk*	190-210	25-35
Quiche, Tarts, Flans		180-210	1 crk	180-200	25-45
Patés and Terrines		150-160	1 crk	150-160	1-1½h
Roasting Meat, Poultry	when more	160-180	1 crk*	160-180	see Roasting chart
Scones		210-220	1 crk	220-230	8-12
Shepherd's pie		190-200	1 crk*	190-200	30-40
Soufflés	than one is	170-180	1 crk	170-180	20-30
Vegetables: Baked Jacket Potatoes		180-190	1 crk	180-190	1-1½h
Roast Potatoes		180-190	1 crk	180-190	1-1½h
Stuffed Marrow	used	180-190	1 crk	180-190	30-35
Stuffed Tomatoes		180-190	1 crk	180-190	15-20
Yorkshire Puddings: (large)		210-220	1 crk	200-210	25-40
(individual)		200-210	1 crk	200-210	15-25

crk = cranked shelf

* or on a straight shelf on the oven base

Note: Shelf positions are counted from the bottom of the oven.
Do not use the cranked shelf from the grill in the main oven.

ROASTING CHART

ROASTING CHART		
INTERNAL TEMPERATURES - Rare: 50-60°C; Medium: 60-70°C; Well Done: 70-80°C		
MEAT	SECOND/FAN OVEN	COOKING TIME
Beef	160-180°C	20-35 minutes per ½kg (1lb) and 20-35 minutes over
Beef, boned	160-180°C	25-35 minutes per ½kg (1lb) and 25-35 minutes over
Mutton and Lamb	160-180°C	25-35 minutes per ½kg (1lb) and 25-35 minutes over
Pork and veal	160-180°C	30-40 minutes per ½kg (1lb) and 30-40 minutes over
Ham	160-180°C	30-40 minutes per ½kg (1lb) and 30-40 minutes over
Chicken	160-180°C	15-20 minutes per ½kg (1lb) and 20 minutes over
Turkey and goose	160-180°C	15-20 minutes per ½kg (1lb) up to 3½kg (7lb) then 10 minutes per ½kg (1lb)
Duck	160-180°C	25-35 minutes per ½kg (1lb) and 25-30 minutes over
Pheasant	160-180°C	35-40 minutes per ½kg (1lb) and 35-40 minutes over
Rabbit	160-180°C	20 minutes per ½kg (1lb) and 20 minutes over
Potatoes with meat	160-180°C	according to size
Potatoes without meat	180-190°C	according to size

The roasting temperatures and times given in the chart should be adequate for most joints, but slight adjustments may be required to allow for personal requirements and the shape and texture of the meat. However, lower temperatures and longer cooking times are recommended for less tender cuts or larger joints.

Wrap joints in foil if preferred, for extra browning uncover for the last 30 - 60 min. cooking time.

DEFROST FEATURE

USES OF DEFROST FEATURE

This fan oven function defrosts most foods faster than more conventional methods. It is particularly suitable for delicate frozen foods which are to be served cold e.g. cream filled gateaux, cakes covered with icings or frostings, cheesecakes, biscuits, scones, etc.

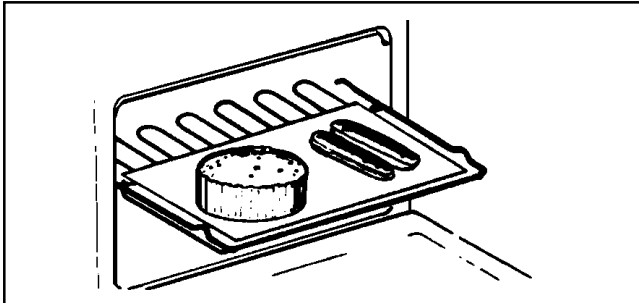

It is preferable to thaw fish, meat and poultry slowly in the fridge. However, this process can be accelerated by using the defrost function.

SELECTING DEFROST

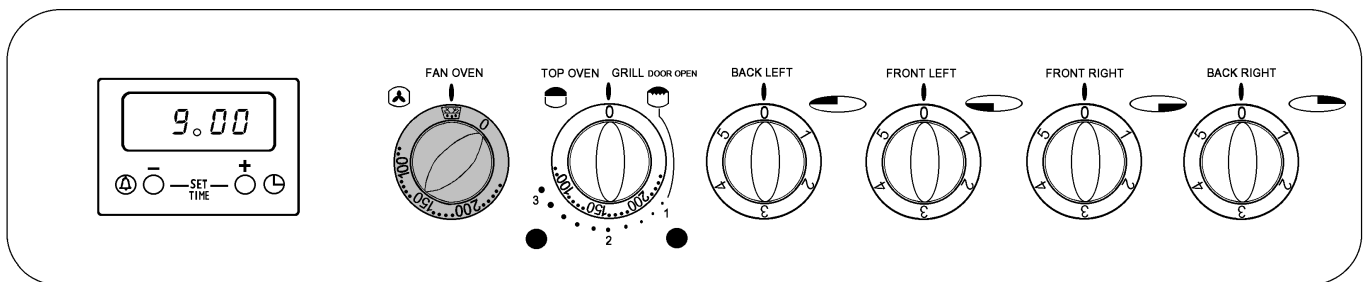

- Turn the main oven temperature control to the defrost setting. 

THINGS TO NOTE

1. When defrost is selected, the oven indicator neon may come ON. It will stay ON until the oven reaches room temperature and then go OFF. It may cycle ON and OFF periodically during defrosting to maintain a steady room temperature, inside the oven.
2. Care must always be taken when handling foods in the home. Always follow the basic rules of food hygiene to prevent bacterial and microbial growth and cross contamination when defrosting, preparing, cooking, cooling and freezing foods.

Small or thin fish fillets, frozen peeled prawns, cubed or minced meat, liver, thin chops, steaks etc., can be thawed in 1 - 2 hours.

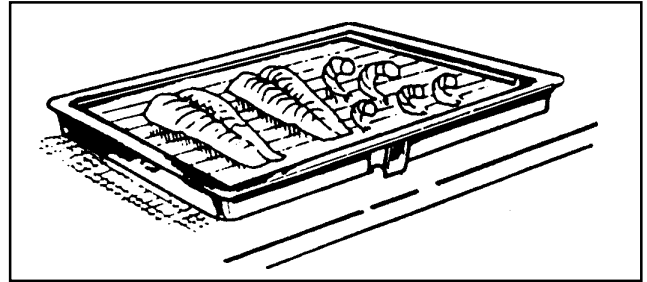

A 1kg/2¼lb oven ready chicken will be thawed in approximately 5 hours. Remove the giblets as soon as possible during the thawing process.

Joints of meat up to 2kg/4½lb in weight can be thawed using the defrost function.

ALL JOINTS OF MEAT AND POULTRY MUST BE THAWED THOROUGHLY BEFORE COOKING.

ALWAYS COOK THOROUGHLY IMMEDIATELY AFTER THAWING.

HINTS AND TIPS

- Place the frozen food in a single layer where possible and turn it over half way through the defrosting process.

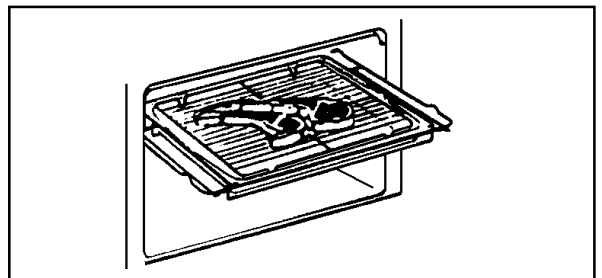

- The actual speed of defrosting is influenced by room temperature. On warm days defrosting will be faster than on cooler days.
- **DO NOT** leave food at room temperature once it is defrosted. Cook raw food immediately or store cooked food in the fridge.

CARE AND CLEANING

ALWAYS SWITCH OFF THE ELECTRICITY SUPPLY AT THE MAIN WALL SWITCH AND ALLOW THE COOKER TO COOL BEFORE CLEANING.

CLEANING MATERIALS

Before using any cleaning materials on your cooker, check that they are suitable and that their use is recommended by the manufacturer.

Cleaners that contain bleach should NOT be used as they may dull the surface finishes. Harsh abrasives should also be avoided. Multi-surface anti-bacterial cleaning products should not be used on the ceramic hob or on the surrounding trims.

CLEANING THE CERAMIC HOB

Make sure the ceramic glass is cool before cleaning. It is important to clean the ceramic hob daily to prevent soilage being burnt on.

Take care to avoid the hob trims when cleaning the ceramic glass as they may be damaged by the cleaning agents recommended.

DAILY CLEANING

Use the recommended Hob Brite Cleaner daily. If soilage is not allowed to burn on it will be much easier to clean off.

1. Apply a small amount of Hob Brite in the centre of each area to be cleaned.

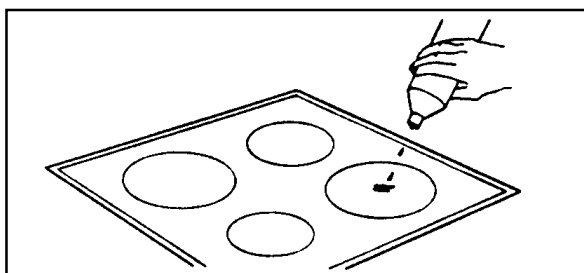

2. Dampen a clean paper towel or a plastic pad made specially for non-stick saucepans and rub vigorously until all marks are removed. This may take a few minutes.
3. Wipe off residues of cleaner with another damp paper towel and polish dry with a soft cloth.

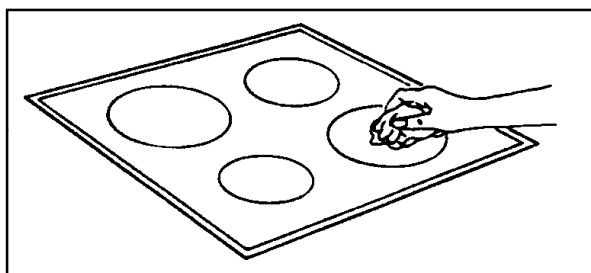

If Hob Brite is unavailable, one or more of the cleaning agents below may be used temporarily:

- a) Jif Cream Cleaner
- b) Baking Soda

TO REMOVE MORE STUBBORN MARKS

1. Bar-Keepers Friend may be used to clean off more stubborn stains or to remove discolourations.

It may be necessary to rub the marks hard for several minutes.

2. Use a plastic pad specially for non-stick saucepans with Bar-Keepers Friend for removal of more stubborn soilage.

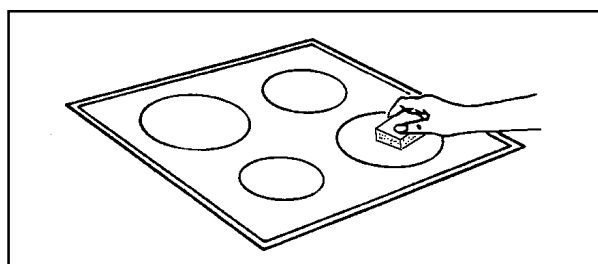

TO REMOVE BURNT ON SOILAGE

We strongly recommend the use of a Ceramic Hob Scraper (incorporating a single edge razor blade) to remove spillage on the hob, in particular sugar solutions, which if not removed can cause permanent damage. If required a Ceramic Hob Scraper can be purchased using the mail order form provided with the hob care kit.

1. Make sure the ceramic glass is cool.
2. Use a ceramic hob scraper with care at an angle of 30° to remove as much soilage as possible.
3. Use Bar-Keepers Friend or Hob Brite to finish off as directed above.

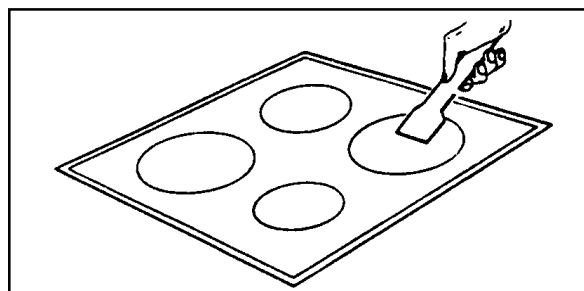

TO REMOVE DISCOLOURATIONS OR WHITE AND SILVER MARKS

These marks sometimes give the impression of being in or underneath the hob glass. They can almost always be removed provided they have not become excessively burnt on. Follow the instructions under 'To Remove more Stubborn Marks' above.

If this is unsuccessful, make up a paste of one part water to three parts Cream of Tartar and leave on the discoloured areas overnight. The marks should be easily removable the next day provided they have not been excessively burnt on. The paste should be thoroughly washed off afterwards.

HINTS AND TIPS

TO REDUCE HOB SOILAGE:

- Make sure the bottom of the saucepan and the cooking area are clean and dry before cooking begins.
- Ensure saucepans are large enough to accommodate food to avoid boil overs.
- If possible, wipe up spills and splatters as they occur, but take care to avoid steam burns.
- Avoid using a dishcloth or sponge to clean the hob. These may leave a layer of soiled detergent on the hob surface which will burn and discolour the next time the hob is used.
- Avoid the use of:
 - Household detergents and bleaches.
 - Impregnated plastic or nylon pads that are not described as suitable for non-stick saucepans.
 - Brillo pads, Ajax pads, steel wool pads.
 - Chemical oven cleaners, e.g. aerosols and oven pads.
 - Rust stain, bath and sink stain removers.
- **Any of the above products may cause damage to the hob.**
- It is dangerous to mix different cleaning products. The chemicals in them may react with each other with hazardous results.

- SOILAGE FROM SUGAR SOLUTIONS MUST BE REMOVED FROM THE HOB BEFORE THE SYRUP HAS SET OTHERWISE DAMAGE TO THE HOB SURFACE WILL OCCUR.
- Avoid placing plastic items, aluminium foil or dishes on the hot surface as this will cause damage to the hob.

CLEANING THE OUTSIDE OF THE COOKER

DO NOT use abrasive cleaning materials, or scourers on the outside of the cooker as some of the finishes are painted and damage may occur. Regularly wipe over the control panel, oven doors and cooker sides using a soft cloth and liquid detergent.

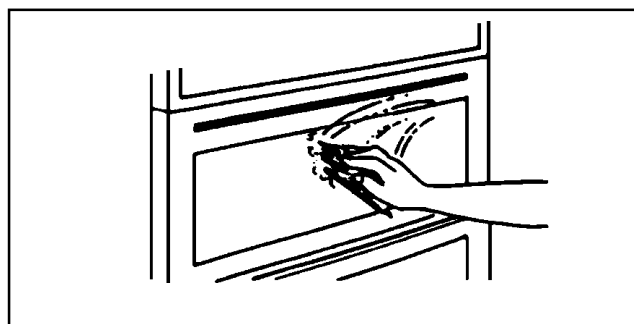

DO NOT ATTEMPT TO REMOVE ANY OF THE CONTROL KNOBS FROM THE PANEL AS THIS MAY CAUSE DAMAGE AND IS A SAFETY HAZARD

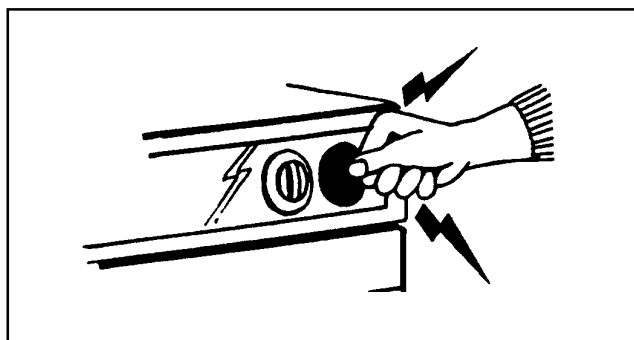

CLEANING THE GRILL PAN, GRILL PAN GRID AND OVEN SHELVES

All removable parts, except the grill pan handle can be washed in the dishwasher.

The grill pan and oven shelves may be cleaned using a soap impregnated steel wool pad. The grill pan grid should be cleaned using hot soapy water. Soaking first in soapy water will make cleaning easier.

CLEANING INSIDE THE GRILL / OVEN COMPARTMENTS

The sides of the main oven are coated with special Stayclean linings.

The Stayclean linings should not be cleaned manually.

The vitreous enamel main oven base, back panel, interior main oven door and top oven/ grill compartment can be cleaned using normal oven cleaners or aerosol oven cleaners with care. Ensure that the manufacturers instructions are followed and that all parts are well rinsed afterwards.

Aerosol cleaners must not be used on the Stayclean linings and must not come into contact with elements as this may cause damage.

For advice on how to keep the Stayclean linings in good condition see 'Care of Stayclean Surfaces'.

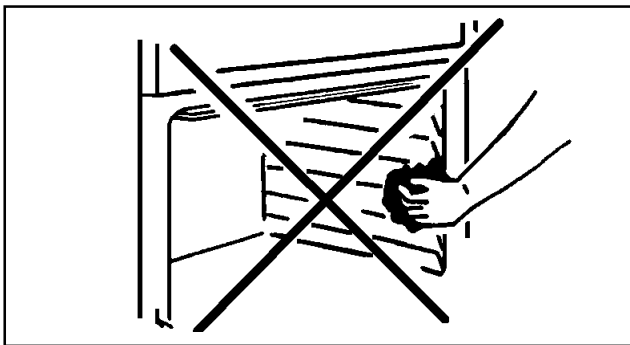

CARE OF STAYCLEAN SURFACES

Stayclean surfaces destroy splashes of food and fats when the oven temperature is raised to around 220°C.

It is a good idea to run the oven for an hour or two per week to ensure continued good performance from the Stayclean finish.

Do use the trivet in the roasting tin. During roasting, the fat from the joint will be contained beneath the trivet and therefore prevent it from splashing onto the Stayclean finish.

HINTS AND TIPS

- Manual cleaning of the Stayclean linings IS NOT recommended. Damage will occur if oven sprays or abrasives of any kind are used.
- Slight discolouration and polishing of the Stayclean linings may occur in time. This does not affect the Stayclean properties in any way.
- A good time to allow the oven to run on is after the weekly roast. After removing the roast, turn the oven up to 220°C and allow to run for an hour or so. It is important NOT to allow a build-up of soilage as this can prevent the Stayclean from working.
- Follow the recommendations below to keep oven soilage to a minimum.
- Cook at the recommended temperatures. Higher temperatures during roasting will increase soilage. Try cooking at lower temperatures for an increased length of time, you will save energy and often the joint is more tender.
- Use minimal, if any, extra oil or fat when roasting meat, potatoes only require brushing with fat before cooking. Extra fat in the oven during roasting will increase splashing and soilage.
- It is NOT necessary to add water to the meat tin when roasting. The water and the fat juices from the joint create excessive splattering during cooking - even at normal temperatures, as well as causing condensation.
- Covering joints during cooking will also prevent splashing onto the interior surfaces. Removing the covering for the last 20-30 minutes will allow extra browning if required. Some large joints and turkeys especially benefit by this method of cooking, allowing the joint to cook through before the outside is over-browned.

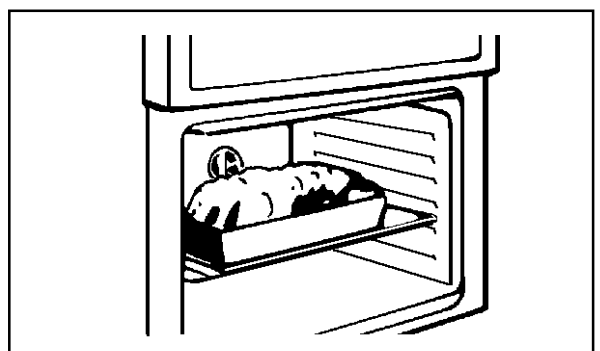

SOMETHING NOT WORKING?

We strongly recommend that you carry out the following checks on your appliance before calling a Service Engineer. It may be that the problem is a simple one, which you can solve yourself without the expense of a service call.

If our Service Engineer finds that the problem is listed below you will be charged for the call whether or not the appliance is under guarantee.

The cooker does not work at all:

- * Check that the appliance has been wired in and is switched on at the wall.
- * Check that the main cooker fuse is working.
- * Check that the timer is set to manual.

The oven temperature is too high or low:

- * Check that the recommended temperatures and shelf positions are being used (see page 20) Be prepared to adjust the temperatures up or down by 10°C to achieve the results you want.

The hotplates and main oven work but the grill does not:

- * Check that you have carefully followed the instructions for operation of the grill.

If the oven is not cooking evenly or the side opening door will not stay open:

- * Check that the cooker is level.

GUARANTEE

Your Electra cooker is covered by the terms of your Electricity Company's guarantee for the period of one year.

In the event of a defect please contact the Service Department of your local Electricity Company.

It is suggested that you record the model number, product number, serial number and date of purchase on the following page. The model and serial numbers of the cooker are detailed on the rating plate. This can be found on the lower front frame of the cooker upon opening the main oven door.

IMPORTANT NOTICE

In line with our continuing policy of research and development, we reserve the right to alter models and specifications without prior notice.

This handbook is accurate at the date of printing, but will be superseded and should be disregarded if specifications or appearance are changed.

SERVICE CALL RECORD

**How to obtain
After Sales Service
quickly**

Remember that you may be charged for a service call (even during the guarantee period) if nothing is found to be wrong with the cooker. So always check the instructions to make sure you have not missed anything.

Make a note of your nearest Electricity Company Service Depot and their telephone number here:

.....

The receptionist will need the answer to certain questions, so to save you time and money, please have the following information ready in case you have to call us.

Your name and address

.....

.....

Telephone number.....

Name of the cooker.....

Model Number.....

Product Number.....

The serial number (shown on the rating plate).....

The showroom where you bought the cooker.....

Date of purchase.....

If free service under guarantee is required, please have available proof of date of purchase when the Service Electrician calls.

In order to provide a complete service history of your cooker , please ask the Service Electrician to record the appropriate details in the chart below.

Date	Nature of Fault	Parts Replaced or Repaired	Signature

MODEL NO.
EL 370



PART NO.
311338904

Free Manuals Download Website

<http://myh66.com>

<http://usermanuals.us>

<http://www.somanuals.com>

<http://www.4manuals.cc>

<http://www.manual-lib.com>

<http://www.404manual.com>

<http://www.luxmanual.com>

<http://aubethermostatmanual.com>

Golf course search by state

<http://golfingnear.com>

Email search by domain

<http://emailbydomain.com>

Auto manuals search

<http://auto.somanuals.com>

TV manuals search

<http://tv.somanuals.com>