



Key Features:

- **Selectable polar pattern to easily adapt to different acoustic environments. Choose between omni, cardioid, supercardioid or figure 8.**
- **Exceptional sound quality with EV's proven PolarChoice design.**
- **Consistent microphone voicing across all four patterns.**
- **Easy to use mute switch. Can be programmed to operate as either latching on/off or momentary push-to-mute / push-to-talk.**
- **Disassembly of the mic isn't required to change switch functions or for use with automatic mixers.**
- **Compatible with echo cancellation for conference applications.**
- **High visibility blue LED clearly displays mic status to the user and can be remotely controlled in automatic mixer mode.**



General Description:

The PC Boundary mic is a low profile microphone that can be used with standard and automatic mic mixers. The PC Boundary mic is a member of the EV PolarChoice™ series of multi-pattern microphones. The multi-pattern versatility of the PolarChoice™ microphone makes it a true “problem solver”. With one non-directional and three directional polar patterns available, PolarChoice™ microphones are ideal for virtually any installation. Of particular interest is the figure 8 pattern that allows miking people on opposite sides of a table with only one microphone, while providing a dramatic reduction of ambient room noise.

The PC Boundary mic features a large soft-touch mute button. The mute button can be configured for push-on / pushoff, push-to-talk, or push-to-mute functions. Mute switch programming is easily accomplished without disassembling the microphone. The microphone can also be programmed to be either live or muted when power is initially applied (when in toggle mode). Additionally, a switch on the bottom of the mic, quickly converts the PC Boundary to automatic mixer mode. In this mode, audio is always on.

A large blue LED indicator lights when the mic is active, and can be remotely controlled when the mic is in automatic mixer mode.

The PC Boundary mic is designed to take acoustic advantage of placing a microphone close to a “boundary” such as conference table. Advantages include reduced phase cancellation and up to 3dB reduction in ambient noise.

The PC Boundary mic also includes a switchable high pass filter and a high-performance vibration-damping pad on the bottom to greatly reduce any vibration induced noise pick-up.

Switch Setting Guide:

Audio (Switches A & B)

A – Hi Pass Filter

Start with this switch set to the left (flat response). If the mic is in a location where low frequency rumble or wind noise is encountered, moving this switch to the right will help by reducing low frequency sensitivity.

B – Polar Pattern

The cardioid polar pattern works well for most installations. If feedback from a sound system occurs, switching to the supercardioid pattern will usually allow increased mic gain before feedback. The figure 8 pattern can be used to mic two people sitting on opposite sides of a table, potentially reducing the total number of mics required. The omnidirectional pattern is best suited for situations where there is no sound reinforcement system present, such as for recording.

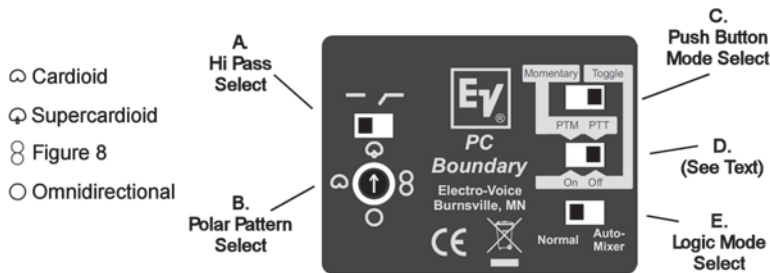

Figure 1:
Mic Switch Interface

Mute Switch Configuration (Switches C & D)

(The membrane switch on the top of the PC Boundary microphone.)

Momentary modes:

When switch “C” is set to the left, the mute switch action is momentary. (If switch “D” is in the left hand position, the mic will be in push-to-mute mode. If switch “D” is in the right hand position, the mic will be in push-to-talk mode.)

Toggle Modes:

When switch “C” is in the right hand position, the mute switch will be in toggle (push-on / push-off) mode. (When the mic is in this mode, the setting of switch “D” determines if the mic audio should be muted when power is first applied. If switch “D” is in the right hand position, the mic audio will be muted when power is first applied. If switch “D” is in the left hand position, mic audio will be on when power is first applied.)

Logic Mode Select (Switch E)

When switch “E” is set to the left, the PC Boundary operates as a normal microphone. Mic muting and operation of the LED is controlled by the pushbutton on the top of the mic.

When switch “E” is set to the right hand position, the mic will be in automatic mixer mode, and the following will apply:

- 1) Mic audio is always on.
- 2) The automatic mixer controls LED operation.

Logic Signals

Logic signal cable hookup guide:

- Green – Logic Ground
- White – Switch Logic
- Orange – LED Control

If the PC Boundary mic is in momentary mode (see above section on the mute switch), the logic level on the white wire will normally be “high”, and go “low” when the mute button is pressed. If the mute switch is set for toggle mode, the logic will toggle from high to low, or from low to high, each time the button is pressed. (If desired, a pc board change can be done to force the logic to always be momentary, regardless of switch settings. See diagram.)

LED Control

When the mic is in automatic mixer mode, a low logic signal on the orange LED control wire will cause the LED to light.

Logic Ground Lift

If necessary, the logic and audio grounds can be separated. This requires removing a resistor from the pc board. See diagram.

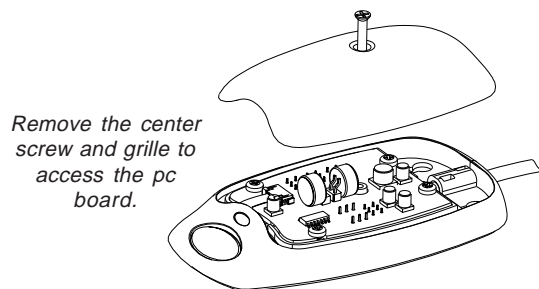

Figure 2:
PCB Access

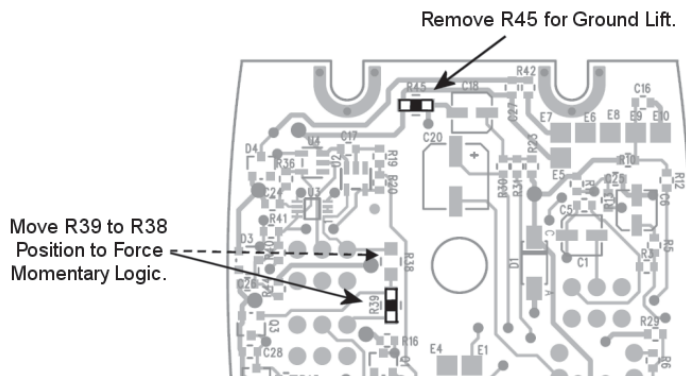

Figure 3:
PCB Jumper Locations

Applications:

The PC Boundary is acoustically designed for high-quality sound reinforcement and broadcast applications. The frequency response is tailored for wide-range sound reproduction with very natural sound pick-up. The PC Boundary microphone's three directional polar patterns allow the user to pick the directional polar pattern for optimum effect. For those applications where gain-before-feedback is not a problem, an omnidirectional pattern is included. The PC Boundary microphone is ideal for boardrooms, conference tables, or anywhere a high quality low profile microphone is required.

Technical Specifications:

Generation Element:

Dual condenser, back electret

Frequency Response:

50 Hz to 20,000 Hz (see chart)

Polar Patterns: (see chart)

Omnidirectional
Cardioid
Supercardioid
Figure 8

Switches and Controls:

Top mounted momentary membrane switch
Automix, normal selector
Push on/off, or push-to-mute selector
Power up on/off selector
High-pass enable
4-position polar pattern selector

Sensitivity, Open Circuit Voltage, 1 kHz:

31.5mV/Pascal

Clipping Level (1% THD):

>115 dB SPL

Equivalent Noise:

29 dB SPL "A" weighted typical
(0 dB=20 micropascals)

Dynamic Range:

>86 dB

Output Impedance, 1 kHz:

200 ohms

Power Requirements:

Phantom, 12 – 52 VDC

Current Consumption:

< 8 mA with P12 supply

Cable:

10-foot, 5-conductor (2-conductor shielded) black cable, terminated with a professional 3-pin male XLR style connector with gold plated pins.

Polarity:

Pin 2 positive, referenced to pin 3, with positive pressure on the diaphragm

Dimensions:

110.4mm (4.34") long
164.6mm (2.54") wide
25.8mm (1.02") high

Weight:

269 grams (9.5 oz), including cable

Dimension Drawings:

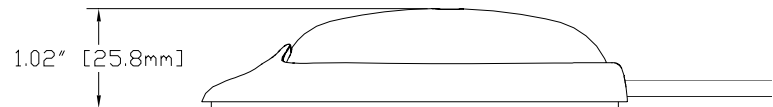
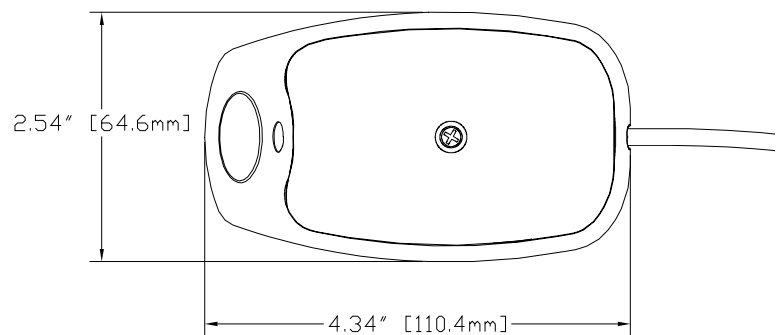

Frequency Response:

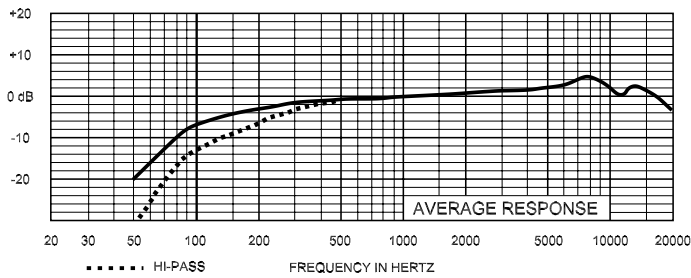

Polar Response:

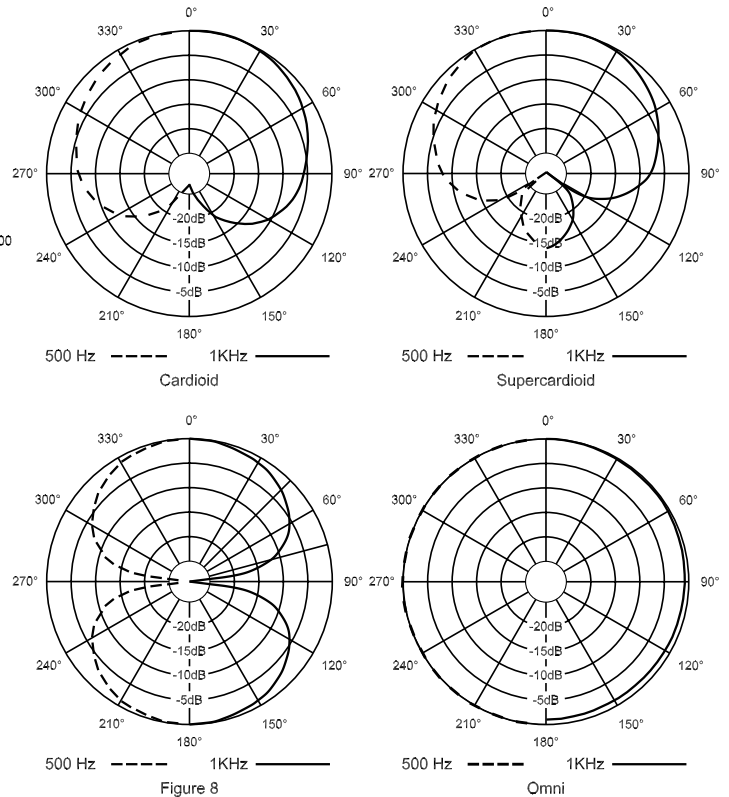

Architectural & Engineering Specs:

PC Boundary

The microphone shall be a low profile boundary microphone. The microphone will have a 10-foot integral 5-conductor, 2-conductor shielded cable terminated in a 3-pin XLRM connector. The microphone shall have four selectable polar patterns: omnidirectional, cardioid, supercardioid, and figure 8. The mic will use a pair of back-electret condenser elements with a frequency response of 50 Hz to 20 kHz. The microphone shall have a nominal, balanced output impedance of 200 ohms. The microphone will have a switchable high-pass filter to roll off low frequencies. The microphone shall have an output level of 5.6 mV/Pascal and outputs shall not be appreciably affected by the following temperature and humidity extremes: -29° to 74° C (-20° to 165°F) when the relative humidity is 0-50%; -29° to 57°C (-20° to 135°F) when the relative humidity is 0-95%. Dimensions shall be 110.4 mm (4.34 in.) long by 64.6mm (2.54 in.) wide by 25.8mm (1.02 in.) high. The microphone will feature a top mounted membrane switch and a status LED that lights when audio is active. The membrane switch will be configurable to operate in either momentary or toggle mode. When the microphone is set in momentary mode, the membrane switch can be programmed to operate in either push-to-mute or push-to-talk mode. When the microphone is set in toggle mode and power is initially applied, the status of the microphone can be programmed to be either on or muted. The microphone will be capable of operation with automatic mixers by means of a configuration switch located on the bottom of the microphone. When the microphone is in automatic mixer mode, normal LED and top push button functions are disabled. In automatic mixer mode, audio will always be on, the top push button will only change the logic level on the microphone's white wire, and a logic low level on the microphone's orange wire will cause the LED to illuminate. All controls except for the push button shall be accessible from the bottom of the microphone base. The microphone base and grille shall be of metal construction. The microphone shall have a nonreflecting black finish. The Electro-Voice PC Boundary microphone is specified.

Ordering Information	
Model No.	Part No.
PC Boundary	PRD000093-000



12000 Portland Avenue South, Burnsville, MN 55337
Phone: 952/884-4051, Fax: 952/884-0043

www.electrovoice.com

© Telex Communications, Inc. 6/2007

Part Number LIT000111 Rev. B



U.S.A. and Canada only. For customer orders, contact Customer Service at:
800/392-3497 Fax: 800/955-6831

Europe, Africa, and Middle East only. For customer orders, contact Customer Service at:
+ 49 9421-706 0 Fax: + 49 9421-706 265

Other International locations. For customer orders, contact Customer Service at:
+ 1 952 884-4051 Fax: + 1 952 736-4212

For warranty repair or service information, contact the Service Repair department at:
800/553-5992 or 402/467-5321

For technical assistance, contact Technical Support at: **800/392-3497 or 952/736-4656**

Specifications subject to change without notice.

Free Manuals Download Website

<http://myh66.com>

<http://usermanuals.us>

<http://www.somanuals.com>

<http://www.4manuals.cc>

<http://www.manual-lib.com>

<http://www.404manual.com>

<http://www.luxmanual.com>

<http://aubethermostatmanual.com>

Golf course search by state

<http://golfingnear.com>

Email search by domain

<http://emailbydomain.com>

Auto manuals search

<http://auto.somanuals.com>

TV manuals search

<http://tv.somanuals.com>