

EVM®12L

12-Inch Classic Lead Guitar Loudspeaker



- Classic lead guitar performance—full, precise overdriven tones and unrivaled clean tones
- Ideal upgrade speaker
- 300 watts long-term power capacity
- Edge-wound flat aluminum wire for maximum output and “bullet proof” reliability
- 100-dB sensitivity

SPECIFICATIONS

Usable Frequency Response in a Typical Vented 1.3-Cubic-Foot Enclosure (1 watt/1 meter; see Figure 1):

80-5,000 Hz

Sound Pressure Level (1 watt/1 meter):
100 dB

Long-Term Average Power Handling Capacity (per EIA RS-426-A 1980; see Power Handling section):
300 watts

Nominal Impedance:
8 ohms

Voice Coil Diameter:
63.5 mm (2.5 in.)

Thiele-Small Driver Parameters

f_s (free-air resonance frequency):
55 Hz

Q_{ES} (electromagnetic Q at f_s):
0.245

Q_{MS} (mechanical Q at f_s):
4.37

Q_{TS} (total Q at f_s): $\frac{(Q_{ES} Q_{MS})}{(Q_{ES} + Q_{MS})}$:
0.232

V_{AS} (volume of air having same acoustic compliance as driver suspension):
82.9 liters (2.9 ft³)

η_o (half-space reference efficiency):
4.3%

V_D (peak displacement volume of diaphragm: $S_D \times X_{Dmax}$):
0.165 liters (0.0059 ft³)

S_D (effective diaphragm area):
0.050 m² (78 in.²)

X_{Dmax} (peak linear displacement of diaphragm):
3.3 mm (0.13 in.)

Mounting Information

(see Installation section),

Mounting Hole Diameter
(eight evenly spaced holes):

7.1 mm (0.28 in.)—letter “L” drill

Bolt Circle Diameter:
294 mm (11.56 in.)

Baffle Opening Diameter
(front or rear mounting):
279 mm (11.0 in.)

Optional Mounting Accessory:
SMH-1 mounting hardware kit

Dimensions (see Figure 2),

Overall Diameter:
310 mm (12.20 in.)

Overall Depth:
138 mm (5.5 in.)

Net Weight:
8.6 kg (19 lb)

Shipping Weight:
10.0 kg (21.5 lb)

DESCRIPTION

The EVM®12L is a 12-inch speaker designed for professional, high-level, high-quality guitar amplification systems. Used full range, the EVM®12L’s frequency response is specifically tailored for brilliant lead guitar performance and classic guitar tones. The EVM®12L incorporates manufacturing refinements that have improved performance. Power capacity is 300 watts per EIA RS-426-A 1980. The Power-Handling section describes these ratings in detail. This improvement in the EVM®12L’s already highly regarded reliability has been made without changing its other performance characteristics in any way.

The construction of the EVM®12L features a low-mass edgewound voice coil on a rugged laminated polyimide coil form, driven by our large, 16-lb magnetic structure. Also featured

are a heavy-duty curvilinear cone and a fatigue-resistant cone suspension. Both the coil and magnetic structure are vented. All of this is packaged around a robust, eight-spoke, diecast aluminum frame.

The EVM®12L may be front- or rear-mounted without an adapter. The optional SMH-1 speaker mounting kit facilitates front mounting (see Installation section).

RECOMMENDED ENCLOSURES

Typical Enclosures

The EVM®12L will often be used to replace inferior speakers in existing enclosures. Mechanical and electrical characteristics are such that the superior efficiency, sound quality and reliability of the EVM®12L will be realized in virtually any sealed, vented (bass reflex) or open-backed enclosure.

Open-backed enclosures have been used for electric guitars from the very beginning. Generally, they offer very good performance in many situations. The sound is often characterized as being open and having a full midbass response. Although these enclosures are often referred to as “warm sounding,” they do not have an especially tight or solid low-end response. The EVM®12L’s performance in this type of enclosure is considered world-class for many music styles.

Sealed enclosures are also very commonly used for guitar—for some very good reasons. Like open-backed enclosures, sealed enclosures are very easy to design and build. The EVM®12L performs very well in virtually any possible sealed enclosure, from 0.9 to 3.0 ft³ (internal volume). The enclosure size makes very little difference within this range. EVM®12L performance in sealed enclosures is tight and punchy. The low end is fast and solid. The overall performance is very focused.

EVM*12L SPECIFICATION GRAPHICS

FIGURE 1 — EVM*12L Frequency Response in Typical Enclosure (1.3 ft³), 1 Watt/1 Meter

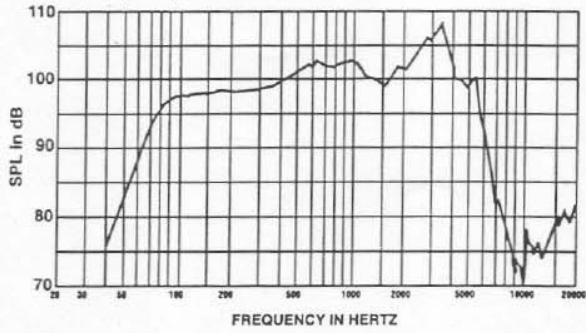

FIGURE 2 — EVM*12L Dimensions

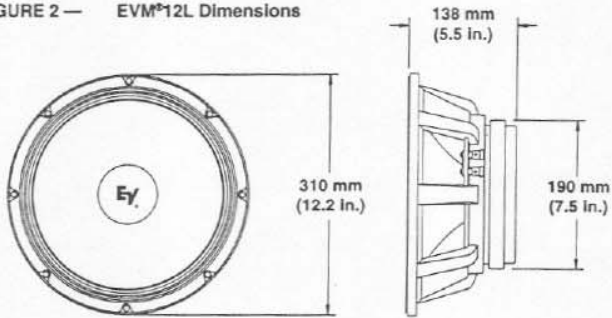

FIGURE 3 — Front Mounting Detail (not to scale)

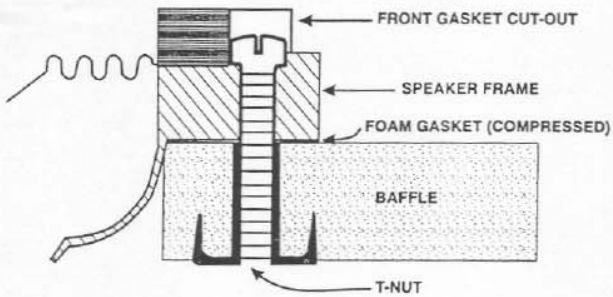

FIGURE 4 — Rear Mounting Detail (not to scale)

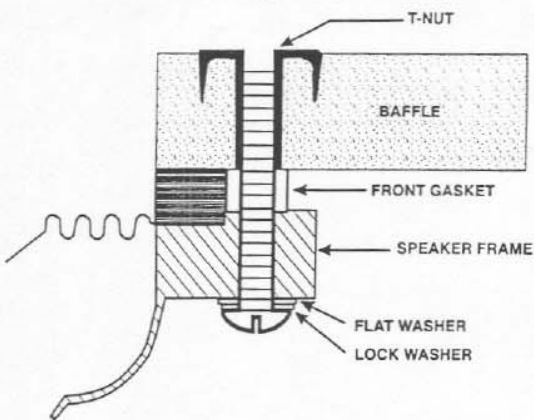

FIGURE 5 — Fillister and Internal Hex Drive Screws for Front Mounting (not to scale)

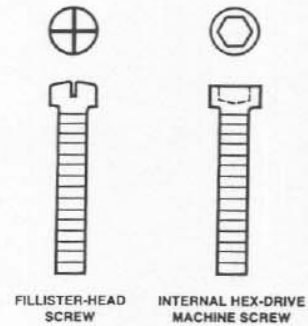

FIGURE 6 — Connection of Two EVM*12L Speakers in Parallel (net Impedance is 4 ohms)

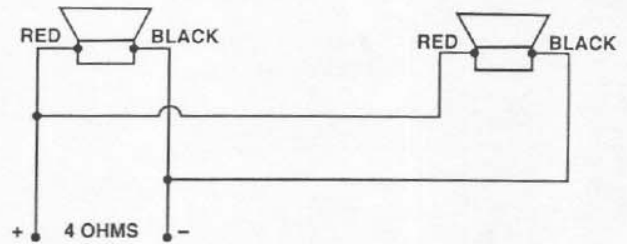

FIGURE 7 — Connection of Two EVM*12L Speakers in Series (net impedance is 16 ohms)

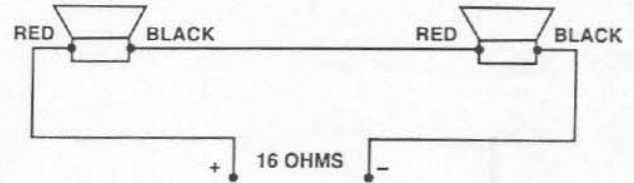
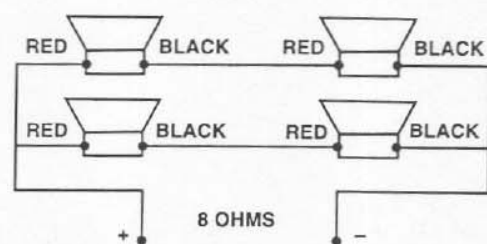

FIGURE 8 — Connection of Four EVM*12L Speakers in Series/Parallel (net impedance is 8 ohms)



Vented Enclosures

The most extended and contoured low-frequency performance with the least amount of distortion is typically realized in properly designed vented enclosures. In such designs, the vent, or port, actually reproduces the lowest octave or so of bass response. The vent is driven to full acoustic output by a relatively small motion of the speaker cone itself, acting through the air contained within the enclosure. The excursion of the EVM®12L at these frequencies is much reduced compared to sealed or open-backed enclosures, directly reducing harmonic distortion.

Details on vented box design, construction and equalization may be obtained from Electro-Voice by requesting "TL806 Builders Plans" (Form 1544-523).

INSTALLATION

The EVM®12L may be front- or rear-mounted, although front mounting is preferred because of convenience. For simple front mounting, the convenient SMH-1 mounting accessory is recommended. Complete mounting instructions for standard front mounting are given below. It is important that recommended baffle openings and mounting hole locations be followed.

Front Mounting

Front mounting requires a 279-mm (11.0-in.) diameter cutout and a 294-mm (11.56-in.) bolt circle. Mark the baffle opening and screw locations on the blank panel first. Drill the screw holes before cutting the large baffle opening. If 1/4-20 screws are used, four screws are sufficient for secure mounting of the speaker. T-nuts are recommended for simple, secure mounting. If T-nuts are used, the holes should be 7.1-mm (0.281-in.) diameter (letter "L" drill). Apply glue to the flanges of 1/4-20 long shank T-nuts before driving into the rear of the holes.

Sealing of the front-mounted speaker is accomplished with the adhesive-backed foam gasket segments that are included with your new EVM®12L. Strip off the protective paper and apply the gasket to the rear mounting surface of the speaker rim, making certain that the holes in the gasket line up with the mounting holes in the speaker frame.

Length of the 1/4-20 screws should be 1/2-inch plus the panel thickness when using T-nuts. The screws must be fillister head or internal hex drive machine screws to seat down in the recess of the speaker frame gasket (see Figure 3). Screws should be tightened evenly and securely. Maximum torque possible with a proper size screwdriver should be sufficient.

IMPORTANT! When front mounting, the screw head must fit down into the front gasket cutout (see Figure 3).

Rear Mounting

Rear mounting requires the same diameter cutout and screw circle as front mounting. Other comments regarding the use of T-nuts apply to rear mounting as well.

Screw length should be 3/4-inch plus panel thickness if using T-nuts—longer for standard hex nuts. If hex nuts are used, a second nut should be tightened against the first nut to prevent loosening during operation. A lock washer and flat washer are recommended between the screw head and frame (see Figure 4).

Screws should be tightened evenly, but not excessively. Maximum torque possible with a proper size screwdriver should be sufficient. Do not use adhesive-back gasket segments for rear mounting.

Normal fasteners up to 6 mm (1/4 in.) will fit through the eight holes in the frame. Front mounting is simplest using the optional SMH-1 speaker mounting kit.

Custom Enclosures

If a cabinet is to be constructed from scratch, 3/4-inch solid and jointed or marine plywood is recommended. After construction, be certain interior is completely free of metal filings, wood chips, etc.

Electrical Connections

Use no. 18 or larger stranded wire to connect the loudspeaker to the input panel connector.

POWER-HANDLING

In musical instrument systems, unlike sound reinforcement systems, it is advisable to use speakers that are rated for at least as much power as your amplifier output rating. It is also widely known that heavily overdriven tube amplifiers are usually capable of double their rated output power, and sometimes more. In this situation, the user would be wise to use speakers having a combined rating of two times the amplifier output. The new EVM®12L has a long-term rms power rating of 300 watts. This assures that the speaker has more than enough "thermal headroom" to be confidently used with virtually any guitar amplifier currently available.

To our knowledge, Electro-Voice was the first U.S. manufacturer to develop and publish a power test closely related to real-life conditions. Specifically, the EVM®12L is designed to withstand the power test described in EIA RS-426-A 1980. The EIA test spectrum is applied for eight hours. This shaped signal is sent to a power amplifier with the continuous power set at 300 watts into the 6 ohms EIA equivalent impedance (42.5 volts true rms). Amplifier clipping sets instantaneous peaks at 6 dB above the continuous power, or 1,200 watts peak (85.0 volts peak). This procedure provides a rigorous test of both thermal and mechanical failure modes.

UNIFORM LIMITED WARRANTY

Electro-Voice products are guaranteed against malfunction due to defects in materials or workmanship for a specified period, as noted in the individual product-line statement(s) below, or in the individual product data sheet or owner's manual, beginning with the date of original purchase. If such malfunction occurs during the specified period, the product will be repaired or replaced (at our option) without charge. The product will be returned to the customer pre-paid. Exclusions and Limitations: The Limited Warranty does not apply to: (a) exterior finish or appearance; (b) certain specific items described in the individual product-line statement(s) below, or in the individual product data sheet or owner's manual; (c) malfunction resulting from use or operation of the product other than as specified in the product data sheet or owner's manual; (d) malfunction resulting from misuse or abuse of the product; or (e) malfunction occurring at any time after repairs have been made to the product by anyone other than Electro-Voice or any of its authorized service representatives. **Obtaining Warranty Service:** To obtain warranty service, a customer must deliver the product, prepaid, to Electro-Voice or any of its authorized service representatives together with proof of purchase of the product in the form of a bill of sale or receipted invoice. A list of authorized service representatives is available from Electro-Voice at 600 Cecil Street, Buchanan, MI 49107 (616/695-6831 or 800/234-6831). **Incidental and Consequential Damages Excluded:** Product repair or replacement and return to the customer are the only remedies provided to the customer. Electro-Voice shall not be liable for any incidental or consequential damages including, without limitation, injury to persons or property or loss of use. Some states do not allow the exclusion or limitation of incidental or consequential damages so the above limitation or exclusion may not apply to you. **Other Rights:** This warranty gives you specific legal rights, and you may also have other rights which vary from state to state.

Electro-Voice Speakers and Speaker Systems are guaranteed against malfunction due to defects in materials or workmanship for a period of five (5) years from the date of original purchase. The Limited Warranty does not apply to burned voice coils or malfunctions such as cone and/or coil damage resulting from improperly designed enclosures. Electro-Voice active electronics associated with the speaker systems are guaranteed for three (3) years from the date of original purchase. Additional details are included in the Uniform Limited Warranty statement.

Service and repair address for this product: Electro-Voice, Inc., 600 Cecil Street, Buchanan, Michigan 49107 (616/695-6831 or 800/234-6831).

Specifications subject to change without notice.

Free Manuals Download Website

<http://myh66.com>

<http://usermanuals.us>

<http://www.somanuals.com>

<http://www.4manuals.cc>

<http://www.manual-lib.com>

<http://www.404manual.com>

<http://www.luxmanual.com>

<http://aubethermostatmanual.com>

Golf course search by state

<http://golfingnear.com>

Email search by domain

<http://emailbydomain.com>

Auto manuals search

<http://auto.somanuals.com>

TV manuals search

<http://tv.somanuals.com>