

SL15-2H

High-Output, Two-Way Slant Cinema Surround Speaker System

- High output—complements the potential of digital sound sources
- 94-dB sensitivity
- 300 watts long-term power capacity
- Easy suspension using the optional quick-mount U-bracket
- ISO 2969 treble roll-off (switchable)
- Slanted profile for greater directivity
- 15-inch woofer
- 100° x 50° horn and driver

Description

The Electro-Voice SL15-2H is a 20° slanted baffle two-way, high-efficiency speaker system. Its primary intended application is for high-quality surround sound in medium and large premium cinema installations. It has been designed for high-power digital surround sound requirements using high-quality, professional-level components such as a high-frequency 100° x 50° horn/driver and a 15-inch woofer. The sleek black-vinyl enclosure with a black cloth grille attached with four screws has been selected to blend into most interior design concepts.

A second-order (12-dB-per-octave) crossover at 3,300 Hz is used to separate the two frequency sections and provide equalization for the HF driver. The bass section was designed for efficient low-end performance in a compact slant-designed enclosure.

Frequency Response

The SL15-2H axial frequency response was measured in Electro-Voice's large anechoic chamber at a distance of 10 feet with a swept sine-wave input (see Figure 1). The two responses ISO 2969 and "flat" are illustrated.

Directivity

The directional characteristics of the SL15-2H were measured in Electro-Voice's large anechoic chamber. The test signal was one-third-octave filtered pink noise at the frequencies indicated. A full spherical measurement system was used. All directional information was measured at 20 feet. Figure 2 illustrates the horizontal and vertical polar responses.

Figure 3 shows the horizontal and vertical beamwidths. Beamwidth is the angle at which the horizontal and vertical polar responses have decreased in level by 6 dB when compared with the axial frequency response.

Figure 4 illustrates the total directivity of the SL15-2H. The directivity factor $R_0(Q)$ is the relative value, at a point, of the SL15-2H output when compared to an ideal spherical response. The directivity index, D_i , is calculated by $D_i = 10 \log_{10} R_0$.

Power-Handling Test

Electro-Voice components and systems are manufactured to exacting standards, ensuring they will hold up, not only through the most rigorous of power tests, but also

through continued use in arduous, real-life conditions. The EIA Loudspeaker Power Rating Full Range (EIA RS-426-A 1980) uses a noise spectrum which mimics typical music and tests the thermal and mechanical capabilities of the components. Electro-Voice will support relevant additional standards as and when they become available. Extreme, in-house power tests, which push the performance boundaries of the system, are also performed and passed to ensure years of trouble-free service.

Specifically, the SL15-2H passes EIA RS-426-A 1980 with the following values:

$$R_{SR} = 6.8 (1.15 \times R_E \text{ ohms})$$

$$P_{E(MAX)} = 300 \text{ watts}$$

$$\text{Test voltage} = \begin{array}{l} 45.167 \text{ volts rms.} \\ 90.4 \text{ volts peak} \end{array}$$

The "peak" power-handling capacity of a woofer is determined by the peak test voltage amount. For the SL15-2H, a 90.4-volt peak test voltage translates into an 1,200-watt short-term-peak power-handling capacity. This is the equivalent of four times the "average" power-handling capacity, and is a peak that can be sustained for only a few milliseconds. However, this sort of short duration peak is very typical in speech and

SL15-2H High-Output, Two-Way Slant Cinema Surround Speaker System

music. Provided the amplifier can reproduce the signal accurately, without clipping, the system will also perform accurately and reliably, even at these levels.

Use in Cinemas

The SL15-2H has features which make it particularly suitable for use as cinema surround sound, a black vinyl appearance to complement most theater interiors. The SL15-MB adjustable bracket provides a cost-effective and safe method of suspending the SL15-2H. The high dynamics and high power handling offered by professional-grade components make it especially suitable for digital surround sound. The SL15-2H is currently pending THX^{®1} approval.

Suspending the SL15-2H

The SL15-2H is fitted with 1/4-20 threaded inserts and can be suspended in two ways using the SL15-MB, a universal U-bracket designed specifically for the SL15-2H. The SL15-2H can be mounted on the wall or, for increased isolation can be hung from the ceiling. The SL15-2H can be locked at angles of 0°, +10°, or +20° (see bracket EDS for more information)

It is the responsibility of the installer to ensure the integrity of the mounting surface. The grille of the SL15-2H is securely attached on the front of the cabinet with four screws.

Architects' and Engineers' Specifications

The loudspeaker system shall be a two-way, 20° slanted baffle design, full-range system consisting of a 15-inch woofer, a 100° x 50° horn and compression driver, using a passive crossover network installed in a black vinyl-clad V-folded particle board enclosure with a black cloth grille.

The system shall have a crossover point of 3,300 Hz and have a nominal impedance of 8 ohms. Usable frequency range shall extend from 48-20,000 Hz. Sensitivity shall be at least 93 dB for a 1 watt input at a distance of 1 meter on axis. Long-term power capacity

shall be at least 300 watts, based on ANSI/EIA RS-426-A 1980 standard for full-range loudspeaker systems.

A shorting jumper shall be present to allow the ISO 2969 or "flat" response to be selected. The input panel will be located on the top surface. (See Figure 6.)

Input connections shall be #10 screw terminals on a barrier strip. Suspension of the system shall be achieved through the use of the SL15-MB bracket (for ceiling or wall suspension), three 1/4-20 threaded inserts are located on the side panels of the speaker enclosure to accommodate the SL15-MB bracket.

Overall dimensions shall be no greater than 477.5 mm (18.8 in.) high by 703.5 mm (27.2 in.) wide and a maximum depth of 349.3 mm (13.75 in.)

Net weight shall be 24.0 kg (53 lb). The system shall be the Electro-Voice SL15-2H.

Uniform Limited Warranty

Electro-Voice products are guaranteed against malfunction due to defects in materials or workmanship for a specified period, as noted in the individual product-line statement(s) below, or in the individual product data sheet or owner's manual, beginning with the date of original purchase. If such malfunction occurs during the specified period, the product will be repaired or replaced (at our option) without charge. The product will be returned to the customer prepaid.

Exclusions and Limitations: The Limited Warranty does not apply to: (a) exterior finish or appearance; (b) certain specific items described in the individual product-line statement(s) below, or in the individual product data sheet or owner's manual; (c) malfunction resulting from use or operation of the product other than as specified in the product data sheet or owner's manual; (d) malfunction resulting from misuse or abuse of the product; or (e) malfunction occurring at any time after repairs have been made to the product by anyone other than EVI Audio Service or any of its authorized service representatives. **Obtaining Warranty Service:** To obtain warranty service, a customer

must deliver the product, prepaid, to EVI Audio Service or any of its authorized service representatives together with proof of purchase of the product in the form of a bill of sale or receipted invoice. A list of authorized service representatives is available from EVI Audio Service at 600 Cecil Street, Buchanan, MI 49107 (800/234/6831 or FAX 616/695/4743). **Incidental and Consequential Damages Excluded:** Product repair or replacement and return to the customer are the only remedies provided to the customer. Electro-Voice shall not be liable for any incidental or consequential damages including, without limitation, injury to persons or property or loss of use. Some states do not allow the exclusion or limitation of incidental or consequential damages so the above limitation or exclusion may not apply to you. **Other Rights:** This warranty gives you specific legal rights, and you may also have other rights which vary from state to state.

Electro-Voice Speakers and Speaker Systems are guaranteed against malfunction due to defects in materials or workmanship for a period of five (5) years from the date of original purchase. The Limited Warranty does not apply to burned voice coils or malfunctions such as cone and/or coil damage resulting from improperly designed enclosures. Electro-Voice active electronics associated with the speaker systems are guaranteed for three (3) years from the date of original purchase. Additional details are included in the Uniform Limited Warranty statement.

For warranty repair, service information, or a listing of the repair facilities nearest you, contact the service repair department at: 616/695-6831 or 800/685-2606.

For technical assistance, contact Technical Support at 800/234-6831 or 616/695-6831, M-F, 8:00 a.m. to 5:00 p.m. Eastern Standard time.

Specifications subject to change without notice.

1. THX is a registered trademark of Lucasfilm Ltd.

SL15-2H High-Output, Two-Way Slant Cinema Surround Speaker System

Figure 1—Axial Frequency Response
(anechoic environment, 1 watt at 1 meter into mid band)

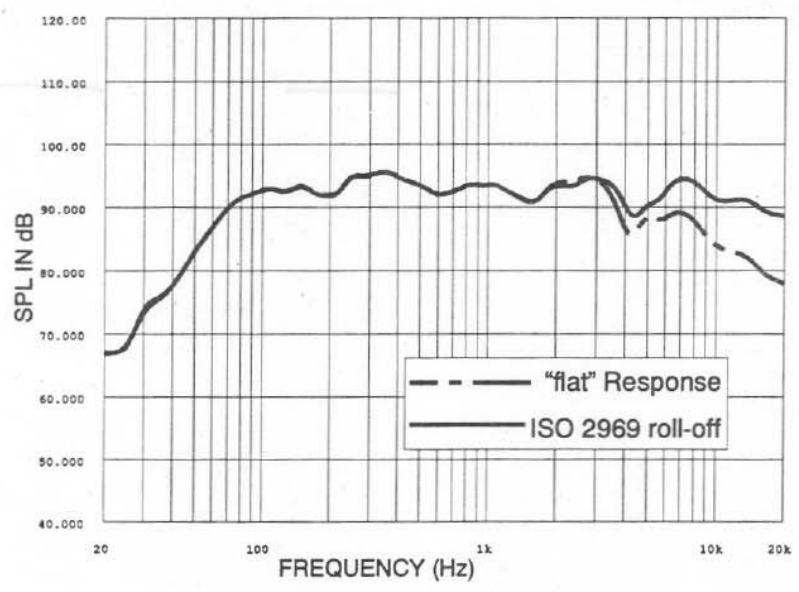
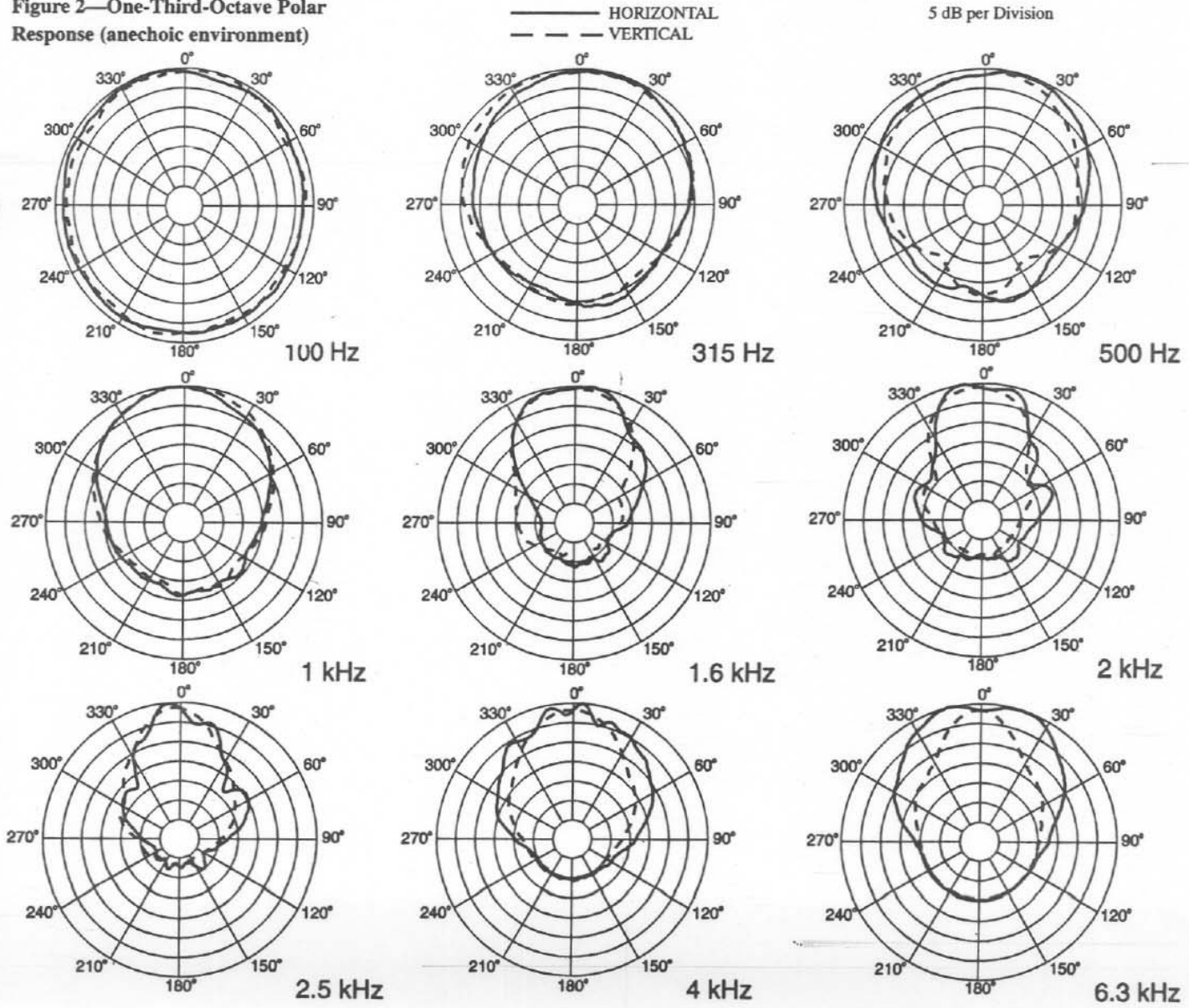

Figure 2—One-Third-Octave Polar Response
(anechoic environment)



SL15-2H High-Output, Two-Way Slant Cinema Surround Speaker System

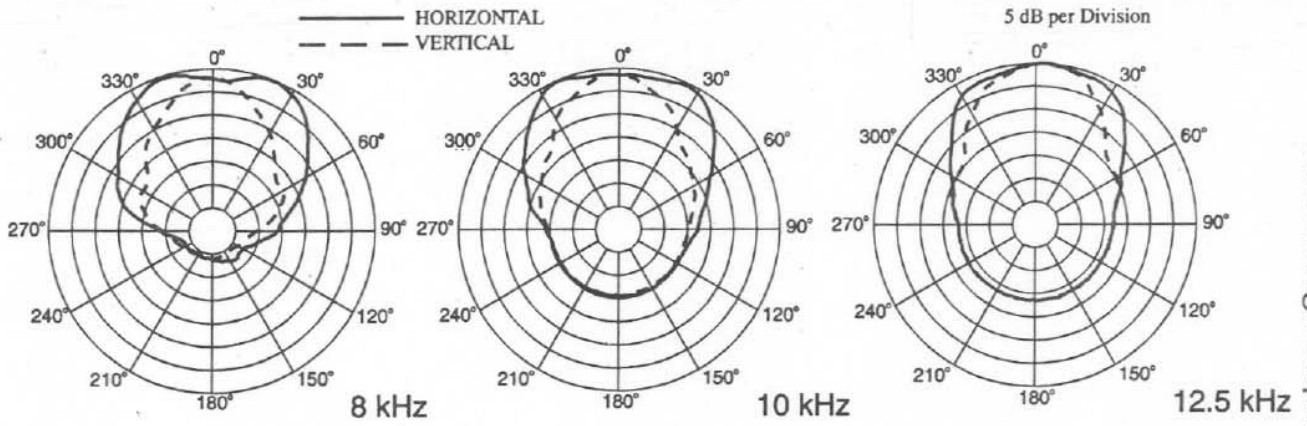

Figure 3—Beamwidth vs. Frequency (anechoic environment)

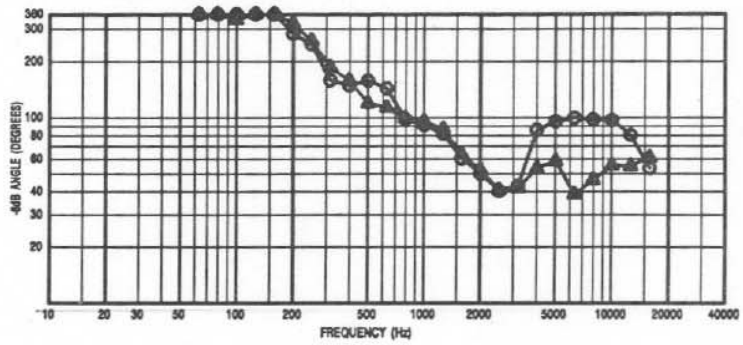

Figure 4—Directivity vs. Frequency (anechoic environment)

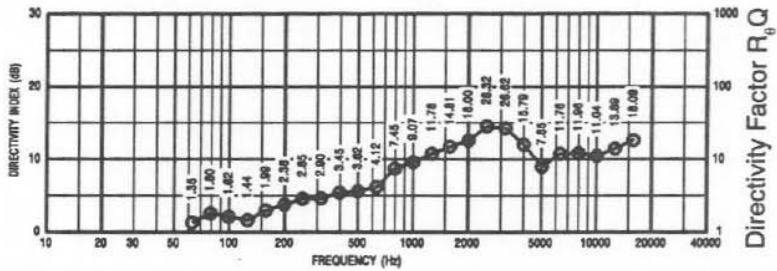
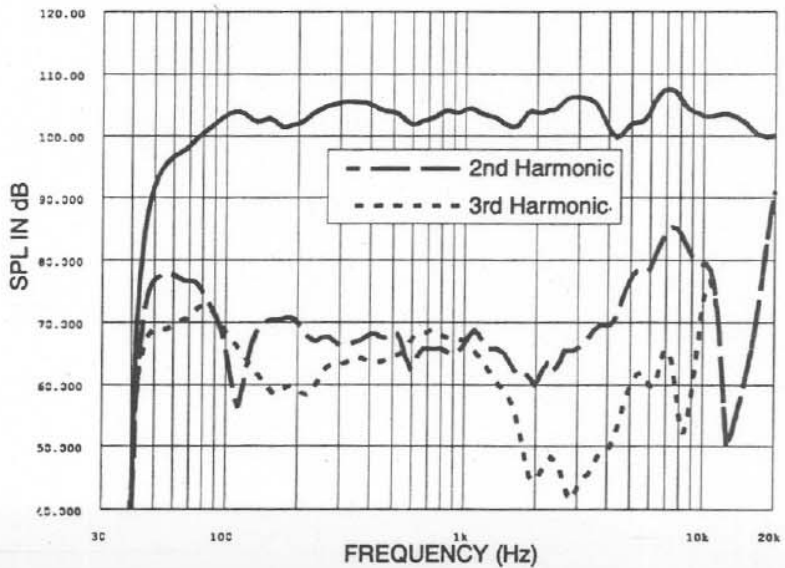

Figure 5—Harmonic Distortion, 0.1 Rated Power Input (10 watts), "flat" response



SL15-2H High-Output, Two-Way Slant Cinema Surround Speaker System

SL15-2H High-Output, Two-Way Slant Cinema Surround Speaker System

Figure 6—SL15-2H Dimensions and ISO Selection

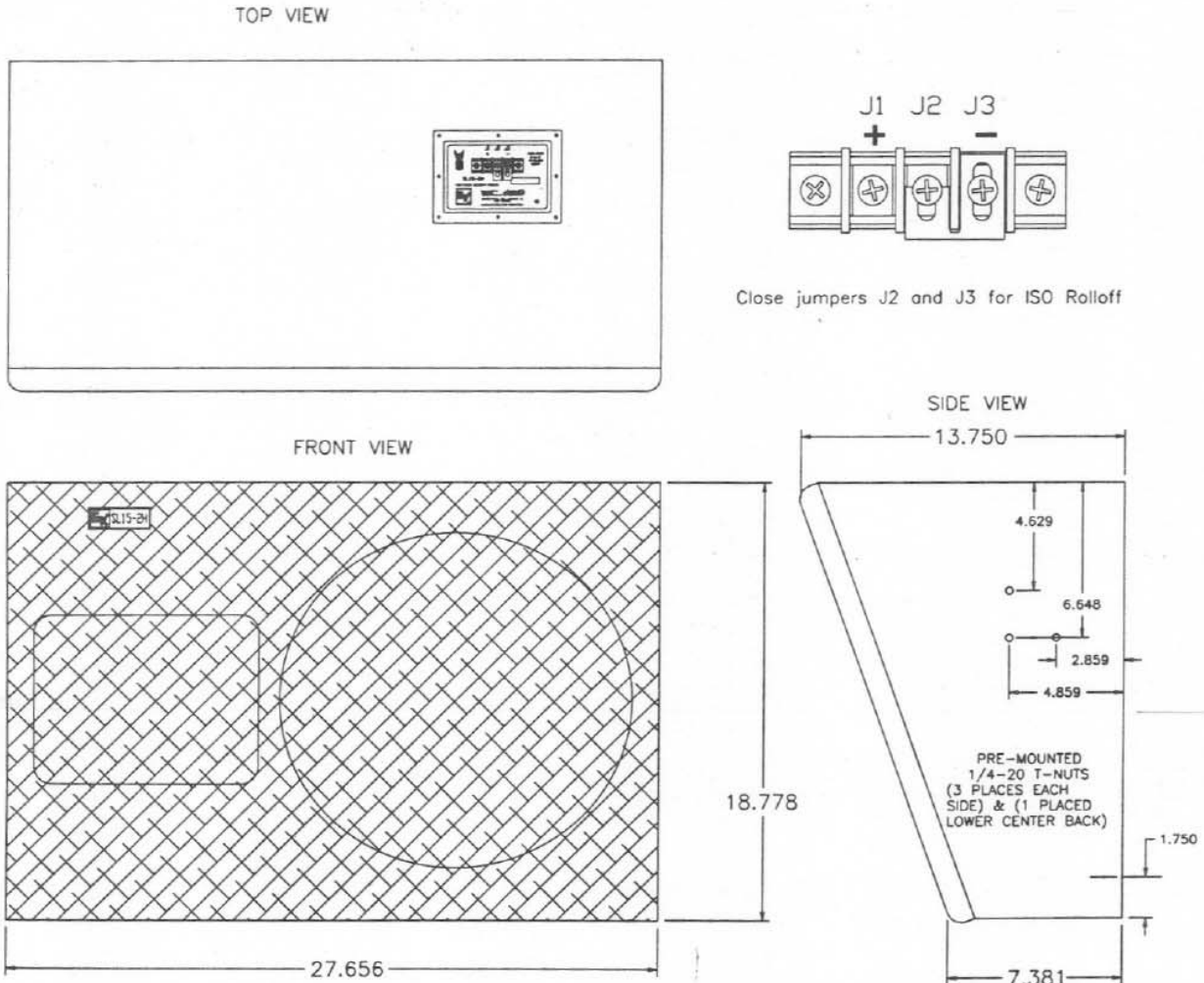

SL15-2H High-Output, Two-Way Slant Cinema Surround Speaker System

Figure 7—Impedance ("flat" response)

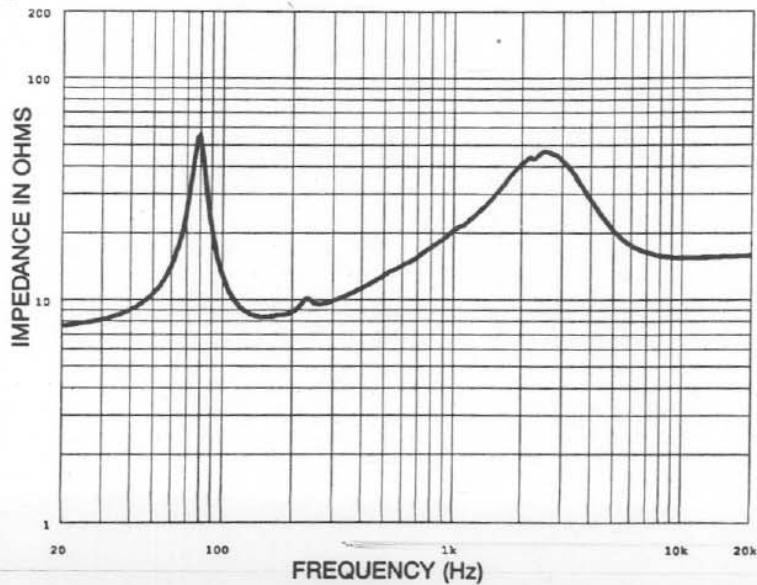

SL15-2H High-Output, Two-Way Slant Cinema Surround Speaker System

Figure 8—Crossover Response

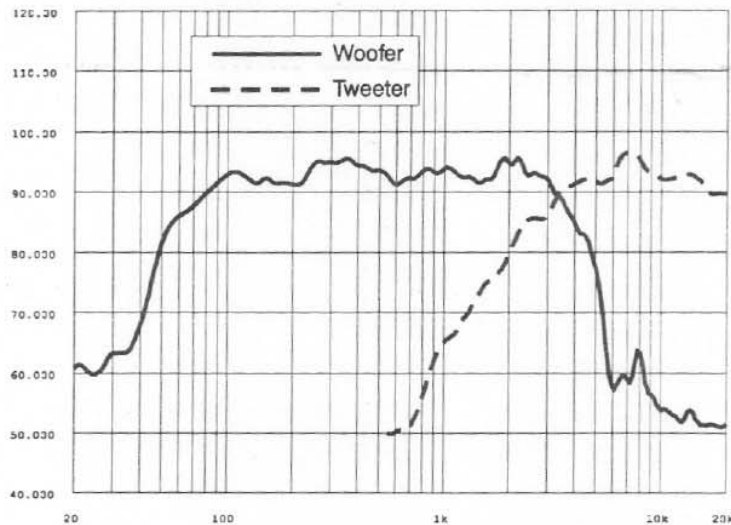

SL15-2H High-Output, Two-Way Slant Cinema Surround Speaker System

Specifications

Axial Frequency Response (swept sine wave, 4 volts at 10 feet on axis, anechoic environment normalized for 1 watt/1 meter; (see Figure 1):
75-20,000 Hz

Low-Frequency 3-dB-Down Point:
70 Hz

Usable Low-Frequency Limit (10-dB-down point):
48 Hz

Half-Space Reference Efficiency:
1.98%

Long-Term Average Power-Handling Capacity (per ANSI/EIA RS-426-A 1980; see Power-Handling Capacity section):
300 watts

Maximum Woofer Acoustic Output:
5.94 watts

Sensitivity (SPL at 1 m, 1 W into nominal impedance, anechoic environment, band-limited pink-noise signal, 100-15,000 Hz):
93 dB

Beamwidth (angle included by 6-dB-down points on polar responses, horizontal and vertical planes, indicated one-third-octave bands of pink noise; see Figure 3),

Horizontal 400-16,000 Hz
100° (+50°, -45°)

Vertical 2,000-16,000 Hz
50° (+10°, -10°)

Directivity Factor R_0 (Q), 800-16,000-Hz Median (see Figure 4):
14.75 (+13.57, -7.27)

Directivity Index D_0 , 800-16,000 Hz Median (see Figure 4):
10.0 dB (+4 dB, -4.5 dB)

Distortion, 0.1 Full Power Input (see Figure 5),

Second Harmonic,

100 Hz:

<1%

1,000 Hz:

4%

10,000 Hz:

3%

Third Harmonic,

100 Hz:

1%

1,000 Hz:

<1%

10,000 Hz:

<1%

Transducer Complement,

Low-Frequency:

15-inch woofer

High-Frequency:

DH2010A and 100° x 50° horn

Crossover Frequency:

3,300 Hz (see Figure 8)

Crossover Slope:

12 dB per octave

Impedance (see Figure 7),

Nominal:

8 ohms

Minimum:

6.8 ohms

Response (see Figure 6):

ISO 2969/Flat (in/out) switchable

Input Connections:

Screw terminals (#10) on barrier strip

Enclosure Materials and Colors:

Black vinyl-clad V-folded particle-board enclosure.

Grille:

Black cloth on MDF (medium density fiberboard) frame, permanently attached

Suspension provided with section:

pre installed 1/4-20 T-nuts for use with optional mounting bracket

Optional Accessories:

SL15-MB versatile cinema wall and ceiling bracket kit

Dimensions (see Figure 6),

Height:

477.5 mm (18.8 in.)

Width:

703.5 mm (27.7 in.)

Max. Depth:

349.3 mm (13.75 in.)

Net Weight:

24.04 kg (53 lb)

Shipping Weight:

30.39 kg (67 lb)

Electro-Voice®

600 Cecil Street, Buchanan, MI 49107

616/695-6831, 616/695-1304 Fax

©EVI Audio 1997 • Litho in U.S.A.

Free Manuals Download Website

<http://myh66.com>

<http://usermanuals.us>

<http://www.somanuals.com>

<http://www.4manuals.cc>

<http://www.manual-lib.com>

<http://www.404manual.com>

<http://www.luxmanual.com>

<http://aubethermostatmanual.com>

Golf course search by state

<http://golfingnear.com>

Email search by domain

<http://emailbydomain.com>

Auto manuals search

<http://auto.somanuals.com>

TV manuals search

<http://tv.somanuals.com>