

Use And Care

G U I D E

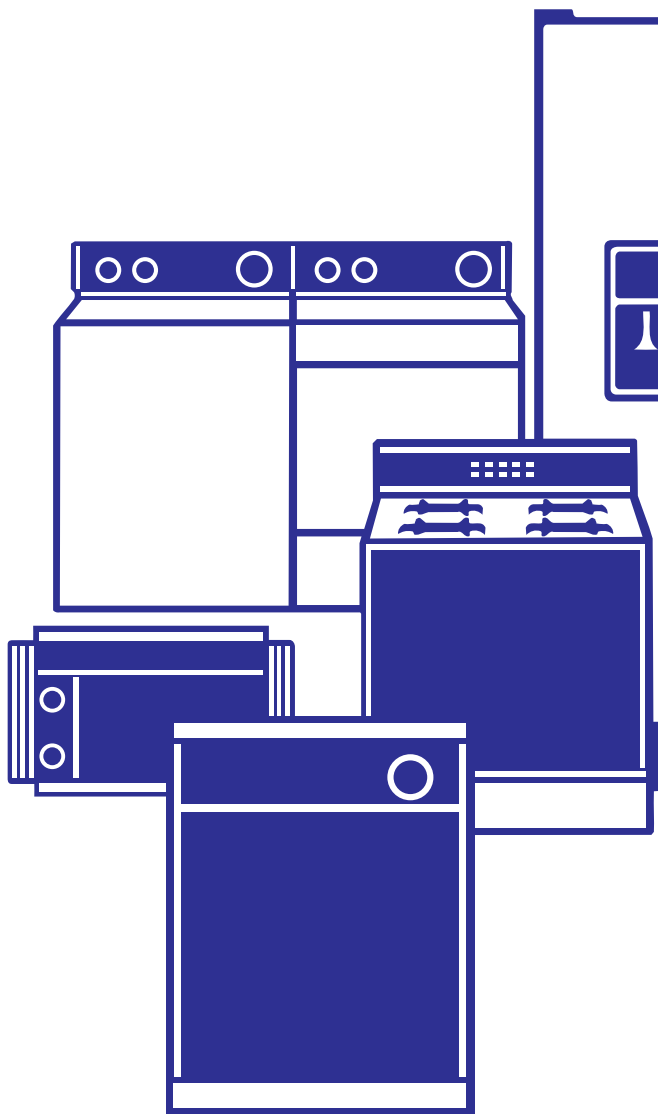

A Note to You	2
Dishwasher Safety	3
Parts and Features	4
Using Your Dishwasher	6
Before starting your dishwasher	6
Starting your dishwasher	8
Adding a dish during a cycle	9
Changing a cycle setting	9
Changing an option	10
Canceling a cycle	10
Cycle selection chart	11
What happens in each option	12
Using the detergent dispenser	13
Using the rinse agent dispenser	14
Quiet operating tips	15
Water temperature tips	15
Energy saving tips	15
Special tips on dishwasher use	16
Loading Your Dishwasher ...	17
Caring for Your Dishwasher	20
Solving Common Dishwashing Problems	23
Troubleshooting	26
Requesting Assistance or Service	27
Index	28
Warranty	32

UNDERCOUNTER DISHWASHER

A Note to You

Thank you for buying an Estate® appliance.

Your ESTATE dishwasher gives you all the functionality of name brand appliances at a value price. To ensure that you enjoy years of trouble-free operation, we developed this Use and Care Guide. It is full of valuable information about how to operate and maintain your appliance properly and safely. Please read it carefully.

Also, please complete and mail the Product Registration Card provided with your appliance. This card helps us notify you about any new information on your appliance.

Please record your model's information.

Whenever you call to request service for your appliance, you need to know your complete model number and serial number. You can find this information on the model and serial number label (See the "Parts and Features" section).

Please also record the purchase date of your appliance and your dealer's name, address, and telephone number.

Model Number _____

Serial Number _____

Purchase Date _____

Dealer Name _____

Dealer Address _____

Dealer Phone _____

Keep this book and the sales slip together in a safe place for future reference.

**Our Consumer Assistance
Center number is toll-free.**

1-800-253-1301

Help us help you

Please:

- Have your dishwasher installed by a qualified installer.
- Install where dishwasher is protected from the elements.
- Install and level dishwasher on a floor that will hold the weight, and in an area suitable for its size and use.
- Properly connect dishwasher to electricity, water, and drain.*
- Remove all shipping plugs from hoses and connectors (such as the cap on the drain outlet) before installing.*
- Remove all hang tags and temporary labels.
- Make sure dishwasher is not used by anyone unable to operate it properly.
- Properly maintain dishwasher. See the "Caring for Your Dishwasher" section.

* See Installation Instructions for complete information.

Dishwasher Safety

Your safety and the safety of others is very important.

We have provided many important safety messages in this manual and on your appliance. Always read and obey all safety messages.



This is the safety alert symbol.

This symbol alerts you to hazards that can kill or hurt you and others.

All safety messages will be preceded by the safety alert symbol and the word "DANGER" or "WARNING." These words mean:

⚠ DANGER

You will be killed or seriously injured if you don't follow instructions.

⚠ WARNING

You can be killed or seriously injured if you don't follow instructions.

All safety messages will identify the hazard, tell you how to reduce the chance of injury, and tell you what can happen if the instructions are not followed.

IMPORTANT SAFETY INSTRUCTIONS

WARNING – When using the dishwasher, follow basic precautions, including the following:

- Read all instructions before using the dishwasher.
- Use the dishwasher only for its intended function.
- Use only detergents or rinse agents recommended for use in a dishwasher and keep them out of the reach of children.
- When loading items to be washed:
 - 1) Locate sharp items so that they are not likely to damage the door seal; and
 - 2) Load sharp knives with the handles up to reduce the risk of cut-type injuries.
- Do not wash plastic items unless they are marked "dishwasher safe" or the equivalent. For plastic items not so marked, check the manufacturer's recommendations.
- Do not touch the heating element during or immediately after use.
- Do not operate the dishwasher unless all enclosure panels are properly in place.
- Do not tamper with controls.
- Do not abuse, sit on, or stand on the door or dish racks of the dishwasher.
- To reduce the risk of injury, do not allow children to play in or on the dishwasher.
- Under certain conditions, hydrogen gas may be produced in a hot water system that has not been used for two weeks or more. HYDROGEN GAS IS EXPLOSIVE. If the hot water system has not been used for such a period, before using the dishwasher turn on all hot water faucets and let the water flow from each for several minutes. This will release any accumulated hydrogen gas. As the gas is flammable, do not smoke or use an open flame during this time.
- Remove the door to the washing compartment when removing an old dishwasher from service or discarding it.

– SAVE THESE INSTRUCTIONS –

Parts and Features

Your dishwasher is illustrated below with the parts and features called out. To help you find information on specific parts or features quickly, page references are included.

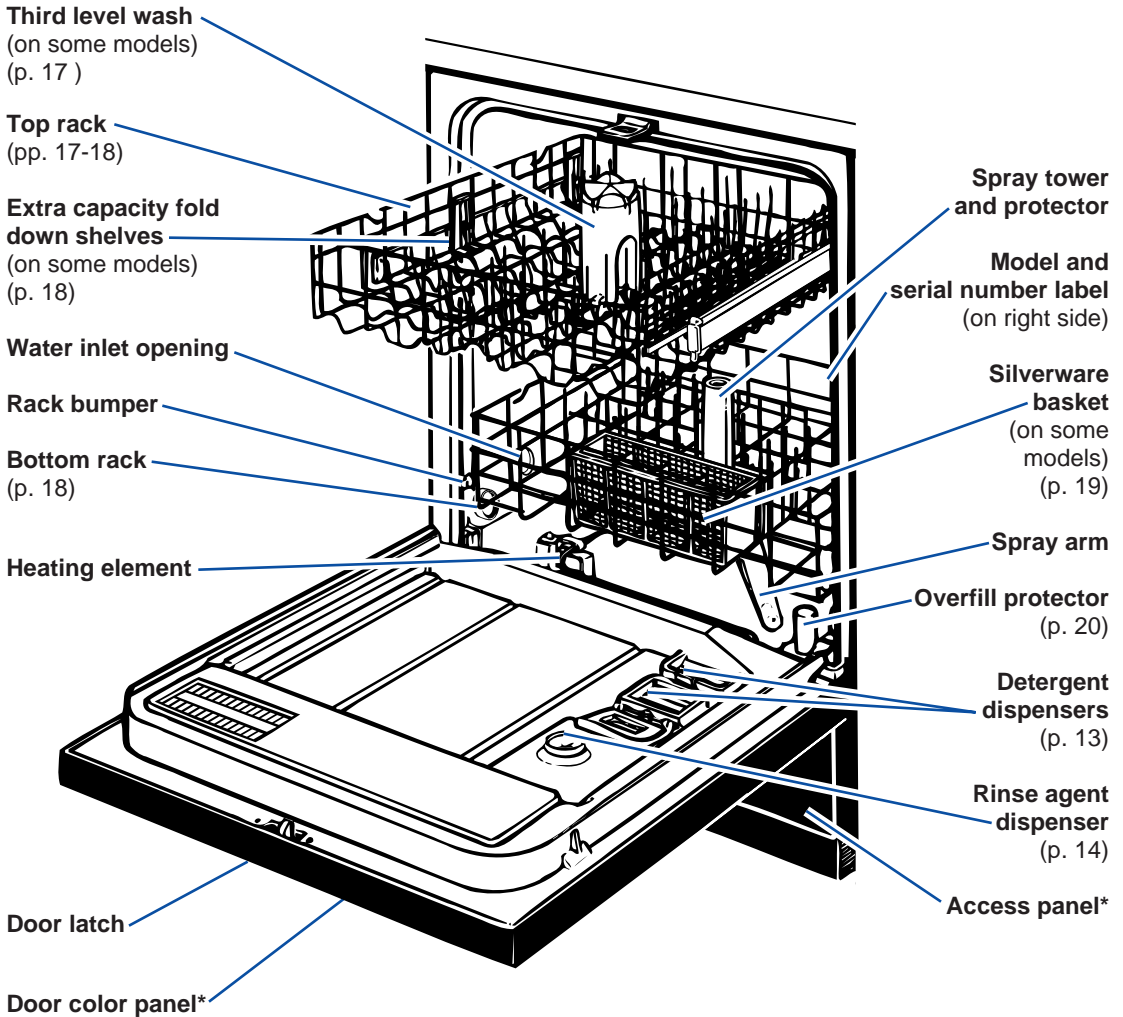

* See Installation Instructions for more information.

Silverware basket
(on some models)
(p. 19)

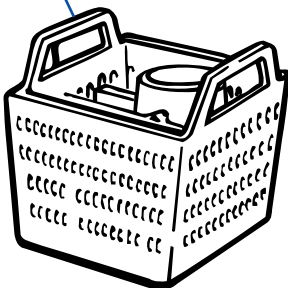

Silverware basket
(on some models)
(p. 19)

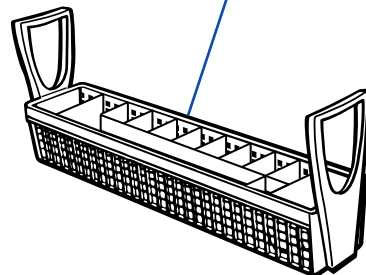

Control Panel

(For rocker switch models)

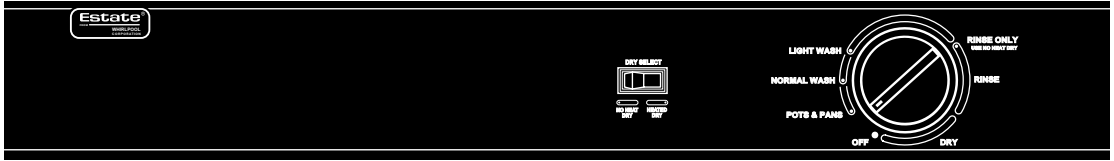

Control Panel

(For seven button models)



Using Your Dishwasher

This section tells you how to start or stop your dishwasher. Refer to it for quick reference.

Before using your dishwasher

⚠ WARNING

Tip Over Hazard Do not use dishwasher until completely installed. Do not push down on open door. Doing so can result in serious injury or cuts.

⚠ WARNING

Electrical Shock Hazard Electrically ground dishwasher. Connect ground wire to green ground connector in terminal box. Do not use an extension cord. Failure to do so can result in death, fire, or electrical shock.

- Install where dishwasher is protected from the elements. Protect against freezing to avoid possible rupture of fill valve. Such ruptures are not covered by the warranty. Refer to the “Storing your dishwasher” section.
- Install and level dishwasher on a floor that will hold the weight, and in an area suitable for its size and use.
- Remove all shipping plugs from hoses and connectors (such as the cap on the drain outlet) before installing. See Installation Instructions for complete information.

GROUNDING INSTRUCTIONS

- For a grounded, cord connected dishwasher:

The dishwasher must be grounded. In the event of a malfunction or break-down, grounding will reduce the risk of electric shock by providing a path of least resistance for electric current. The dishwasher is equipped with a cord having an equipment-grounding conductor and a grounding plug. The plug must be plugged into an appropriate outlet that is installed and grounded in accordance with all local codes and ordinances.

WARNING – Improper connection of the equipment-grounding conductor can result in a risk of electric shock. Check with a qualified electrician or service representative if you are in doubt whether the dishwasher is properly grounded. Do not modify the plug provided with the dishwasher; if it will not fit the outlet, have a proper outlet installed by a qualified electrician.

- For a permanently connected dishwasher:

The dishwasher must be connected to a grounded metal, permanent wiring system, or an equipment-grounding conductor must be run with the circuit conductors and connected to the equipment-grounding terminal or lead on the dishwasher.

– SAVE THESE INSTRUCTIONS –

USING YOUR DISHWASHER

1. Properly load the top rack, bottom rack, and the silverware basket. See the “Loading Your Dishwasher” section.



2. Spin the lower spray arm with lower rack in place to make sure nothing prevents arm from turning freely.

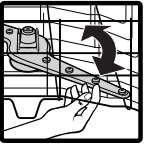

3. Add detergent. See the “Using the detergent dispenser” section.



4. Check the rinse agent dispenser.

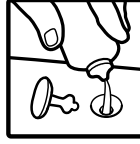

5. Push door firmly when closing and it will automatically latch.

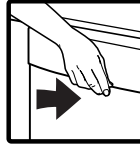

6. Run hot water at sink nearest dishwasher until water is hot. Turn off water.



Starting your dishwasher

The dishwasher will wash and dry dishes according to the selections you make on the control panel.

1. Select a drying option.

NOTE: For the Rinse Only cycle, use No Heat Dry.

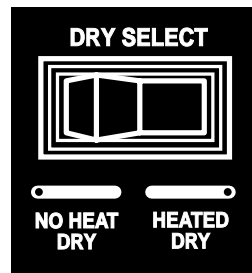

(on some models)



(on some models)

2. For models with cycle selector buttons, select a wash cycle. See “Cycle selection chart” for descriptions. **For models with rocker switches, skip to Step 3.** The Rinse Only cycle will operate with any cycle selector button chosen. The cycle control knob determines which cycle operates.

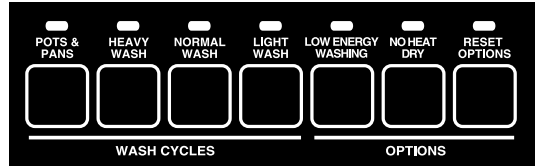

3. Turn the cycle control knob clockwise to point to the desired cycle.

You will feel a definite stop at each cycle mark. The dishwasher will automatically start the cycle you selected.

NOTE: If the door is latched, you will hear cycles start and stop as the knob passes each cycle mark. This is normal and will not hurt the dishwasher. If you prefer, you can set cycles with the door unlatched.

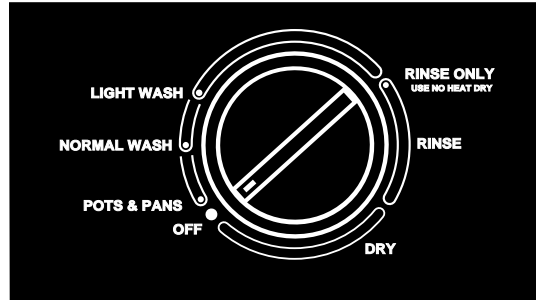

Cycles vary with models

Adding a dish during a cycle

You can add an item to the dishwasher anytime before the knob reaches Light Wash.

1. Lift up on the door latch to unlatch the door and stop the cycle. Wait a moment for the spray action to stop before opening the door.
2. Open the door and add the dish.

3. Close the door. Do not latch it. Wait 30 seconds for air in the dishwasher to warm up. This helps reduce the amount of moisture that can come from the vent when restarting the cycle.
4. Press door in to latch it. The dishwasher will start where it stopped.

Changing a cycle setting

You can change a setting anytime during any cycle. To change the selected option(s):

1. Lift up on the door latch to unlatch the door and stop the cycle.
2. Turn the cycle control knob clockwise to the cycle you want.
3. Check the detergent dispenser to be sure it is properly filled for the new cycle. See the “Using the detergent dispenser” section.

NOTE: Turning the cycle control knob may cause the covered section of the detergent dispenser to open. Be sure to fill the covered section, and close the cover, if the cycle uses detergent in both sections.

4. Close and latch the door. The dishwasher will automatically start the new cycle.

Changing an option

For rocker switch models

You can change the Dry Select option any time during a cycle.

To change the option, select the other drying option.

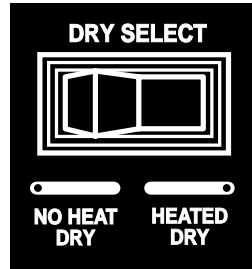

For seven button models

1. Push the reset options button.
2. Push an option selector button for each desired option.

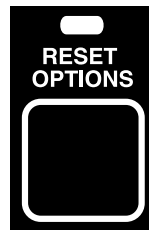





Canceling a cycle

You can cancel a setting anytime during any cycle.

1. Turn the cycle control knob slowly clockwise to the drain portion of the wash or rinse. You will hear water draining when you have advanced to the proper location.
2. Let the dishwasher drain completely.
3. Lift up on the door latch to unlatch the door.
4. Turn the cycle control knob clockwise to point to Off.

Cycle selection chart

Cycle	A "✓" shows what steps are in each cycle							Cycle Time (Minutes)
	Wash	Rinse	Rinse	Main Wash	Rinse	Rinse	Dry	
POTS & PANS  <p>A double wash for maximum cleaning of cooked-on or baked-on foods.</p>	✓	✓	✓	✓	✓	✓	✓	98*
HEAVY WASH (on some models)  <p>A double wash for heavily soiled loads.</p>	✓	✓	✓	✓	✓	✓	✓	98*
NORMAL WASH  <p>A double wash for moderately to heavily soiled loads. (The Energy Guide Label is based on this cycle.)</p>	✓		✓	✓	✓	✓	✓	90*
LIGHT WASH  <p>A single wash for lightly to moderately soiled loads.</p>			✓	✓	✓	✓	✓	85*
RINSE ONLY  <p>For rinsing a few items to be washed 1 or more days later. Do not use detergent. Use Energy Saver Dry option only. Heated Dry option may cause food to bake on dishes.</p>					✓	✓		20*

* Cycle time includes heated dry time.

What happens in each option

Heated Dry option

If the Heated Dry option is selected, air in the dishwasher is heated during the “dry” part of the cycle. For best results, use a liquid rinse agent.

SELECT

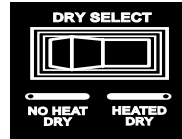

(on some models)

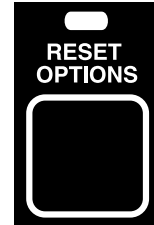

(on some models)

No Heat Dry option

If the No Heat Dry option is selected, air in the dishwasher is not heated during the “dry” part of the cycle. Using this option helps save energy, but dishes take longer to dry (overnight) and some water spotting may result. Some items (such as plastics) may need towel drying. For best drying results, use a liquid rinse agent.

SELECT

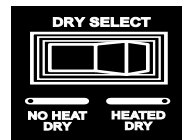

(on some models)



(on some models)

Low Energy Washing option (on some models)

When the low energy washing option is selected, water heating is reduced during the main wash and final rinse. This will reduce the amount of electricity needed to run the dishwasher. However, dishes may not wash as well.



Using delay wash

(on some models)

You can set the dishwasher to start a cycle 1, 2, or 3 hours later.

1. Push desired cycle selector button.
2. Push desired Option selector button(s).
3. Turn cycle control knob clockwise to the number of hours you want the dishwasher to delay before the selected cycle starts.
4. Close and latch the door.

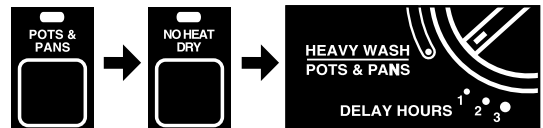

NOTE:

- You can add items while time is counting down. Close and latch the door. The cycle control knob will not advance if the door is unlatched.
- Rinse Only and Light Wash cycles cannot be delayed.

Using the detergent dispenser

- Use **automatic dishwashing detergent only**. Other detergents are too mild and much too sudsy.
- Add detergent just before starting cycle.
- Store detergent tightly closed in a cool, dry place. **Fresh automatic dishwasher detergent results in better cleaning.**

Filling the detergent dispenser

The detergent dispenser has one section with a cover and one without. Push the cover down firmly until it latches. Detergent in the open section falls into the dishwasher when closing the door. The covered section opens automatically when the main wash starts.

NOTE: It is normal for the cover to open partially when dispensing detergent.

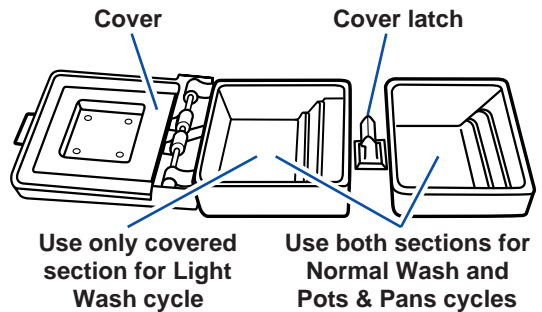

How much detergent to use

- The amount of detergent to use depends on the hardness of your water and the type of detergent. If you use too little, dishes won't be clean. If you use too much in soft water, glassware will etch.
- Different brands of dishwasher detergent have different amounts of phosphorus for softening water. If you have hard water and use a detergent with a phosphorous content of less than 8.7%, you may need to use more detergent, or use a detergent with a phosphorous content higher than 8.7%.
- Determine your water's hardness by asking your local water department or water softener company.

NOTE: Fill amounts shown in chart are for standard powdered detergent. Amounts may vary if you use liquid or concentrated powdered detergent. Follow manufacturer's directions when using liquid dishwasher detergent or concentrated powdered detergent.

WATER TYPE	WHERE TO FILL	
Hard 8+ grains per gallon 136+ parts per million	Top of 3rd step (3 tbs.)	
Medium 5-7 grains per gallon 85-119 parts per million	Top of 2nd step (2 tbs.)	
Soft 0-4 grains per gallon 0-68 parts per million	Top of 1st step (1 tbs.)	

Using the rinse agent dispenser

Rinse agent dispenser

Keep the rinse agent dispenser filled with a liquid rinse agent. A rinse agent greatly improves the drying of dishes by helping water flow off them during the last rinse. A rinse agent also keeps water from forming droplets and drying as spots.

Release of a small amount of rinse agent into the rinse water is automatic in the final rinse of each cycle. For best drying results, check the dispenser periodically to see if it needs refilling.

To check dispenser

Remove dispenser cap. If dispenser is empty, an "E" will be clearly visible inside the dispenser.

The center of the fill indicator cap will be clear when dispenser needs refilling.

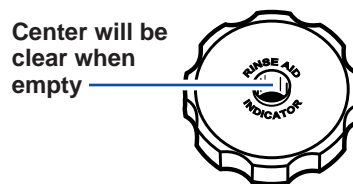

To fill dispenser

You do not have to wait until the dispenser is empty to refill it, but do not overfill it. The dispenser will hold 6 ounces of rinse agent. Under normal conditions, this will last about three months.

1. Make sure the dishwasher door is fully open.
2. Remove the fill indicator cap.
3. Add rinse agent to the dispenser. Do not fill past the smallest opening in the lower part of the dispenser.

If you overfill, excess rinse agent can come out. This will not harm the dishwasher, but could cause over-sudsing.

4. Clean up any spilled rinse agent with a damp cloth.
5. Replace the fill indicator cap and keep it tightly closed.

NOTE: Your dishwasher is designed to use a liquid rinse agent. Do not use a solid or bar-type rinse agent.

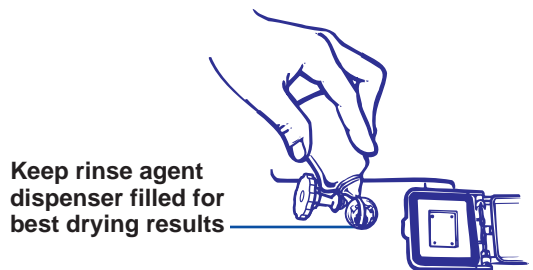

Quiet operating tips

To avoid thumping and clattering noises during operation:

- Make sure lightweight load items are secured in the racks.
- Make sure pot lids and handles, pizza pans, cookie sheets, etc., do not touch interior walls or interfere with the spray arm's rotation, or cover the spray tower.

- Load dishes so they do not touch one another.

NOTE: Keep sink drain plugs inserted during dishwasher operation to prevent noise transfer through drains.

Water temperature tips

Hot water dissolves and activates the dishwashing detergent. Hot water also dissolves grease on dishes and helps dry glasses spot-free.

For best dishwashing results, water must be at least 120°F as it enters the dishwasher. The dishwasher will automatically heat the water to help washing performance.

To check water temperature

1. Run hot water at the faucet closest to your dishwasher. Set a cup under the faucet, and place a candy or meat thermometer in it.
2. Run hot water for at least one minute into



the cup, allowing the water to overflow. Then check the temperature. If the water temperature is below 120°F, have a qualified person raise the thermostat setting on your water heater.

Energy saving tips

You can help save energy if you:

- Wash full loads. Running a half-filled dishwasher uses the same amount of electricity and hot water as a fully loaded machine.
- Use the Light Wash cycle whenever possible. The cycle uses less hot water and energy than the Normal Wash cycle.
- Use the Low Energy Washing option if available. The water heating in the main wash and final rinse will be reduced.

NOTE: Loads may not wash as well if the water temperature is too low.

- Load correctly for best washing results. Incorrect loading may cause poor washing and the need to rewash all or part of the load.
- Do not pre-rinse normally soiled dishes. Select the correct cycle for the load and use the recommended amount of detergent for good washing results without hand rinsing.
- Use your dishwasher during off-peak hours. Local utilities recommend this to avoid heavy usage of energy at certain times of day.
- Use the No Heat Dry option whenever possible. Allow longer drying times (overnight). Use a rinse agent to improve drying.

Special tips on dishwasher use

If you have any doubts about a particular dish, check with the manufacturer to see if it is dishwasher safe.

NOTE: It is the user's responsibility to determine if dishes should be washed in a dishwasher.

Material	Dishwasher Safe?	Exceptions/Special Information
Aluminum	Yes	High water temperature and detergents may affect finish of anodized aluminum.
Bottles and Cans	No	Wash bottles and cans by hand. Labels attached with glue can loosen in your dishwasher. Loose labels and glue can clog spray arm(s) or the pump and will reduce washing performance.
Cast Iron	No	Seasoning will be removed and iron will rust.
China/ Stoneware	Yes	Always check manufacturer's recommendations before washing. Antique, hand-painted or over-the-glaze patterns may fade. Gold leaf may discolor or fade.
Crystal	Yes	Always check manufacturer's recommendations before washing. Some types of leaded crystal may etch with repeated washings.
Gold	No	Gold-colored flatware will discolor.
Glass	Yes	Milk glass will yellow with repeated dishwasher washing.
Hollow-Handle Knives	No	Handles of some knives are attached to the blade with adhesives which may loosen if washed in the dishwasher.
Pewter	No	High water temperatures and detergent may discolor or pit finish.
Disposable Plastics	No	Cannot withstand high water temperatures and detergents.
Plastics	Yes	Always check manufacturer's recommendations before washing. Plastics vary in their capacity to withstand high water temperatures and detergents.
Stainless Steel	Yes	Run a Rinse Only cycle if not washing immediately. Prolonged contact with food containing salt, vinegar, milk products, or fruit juice could damage finish.
Sterling Silver or Silver Plate	Yes	Run a Rinse Only cycle if not washing immediately. Prolonged contact with food containing salt, acid, or sulfide (eggs, mayonnaise and seafood) could damage finish.
Tin	No	May rust.
Wooden Ware	No	Wash by hand. Always check manufacturer's recommendations before washing. Untreated wood may warp, crack, or lose its finish.

Loading Your Dishwasher

This section tells you how to properly load your dishwasher for the best washing and rinsing results.

Preparing to load the dishwasher

- Scrape leftover food, bones, toothpicks, and other hard items from dishes.
- To save water and energy, do not rinse dishes before putting them into the dishwasher.
- Foods like eggs, rice, pasta, and cooked cereals may be hard to remove if they are left to dry over a period of time.
Run a Rinse Only cycle to keep dishes moist if you do not plan to wash them soon.
- Load dishes so soiled surfaces face the rotating spray arms.
- Load dishes so they are not stacked or overlapping. It is important for the water spray to reach all soiled surfaces for best washing. For best drying, water must be able to drain from all surfaces.

Loading the top rack

The top rack is designed for cups, glasses, and other small items. Some models have a third level wash to improve washability. Do not cover the third level wash when loading the top rack.

Cup and glass load

- Place so open ends face down for cleaning and draining.
- Load glasses in top rack only. The bottom rack is not designed for glasses. Damage may occur to glasses in bottom rack.
- Place items in the rows between prongs. Placing them over the prongs can lead to breakage.
- Secure lightweight items.
- China, crystal, and other delicate items must not touch each other during dishwasher operation. Damage may occur.

Cup and glass load

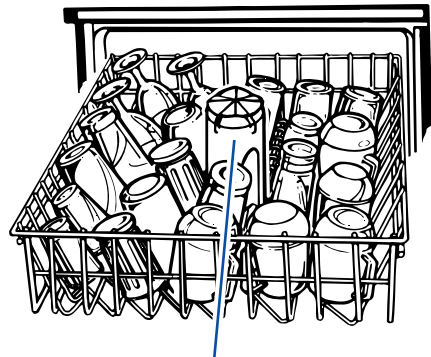

Do not cover third level wash
(on some models)

continued on next page

Mixed load

- Load plastic items in the top rack only. Only plastic items marked “dishwasher safe” are recommended.
- Load plastic items so the force of the spray does not move them during the cycle.
- Plastic items might melt in the bottom rack.

Utensil load

- Small bowls, pans, and other dishes can be placed in the top rack.

Extra-capacity fold-down shelves (on some models)

(on some models)

Extra shelves on one side of the top rack can be folded down over short items (cups, juice glasses, cereal bowls, etc.) to hold extra items.

Mixed load

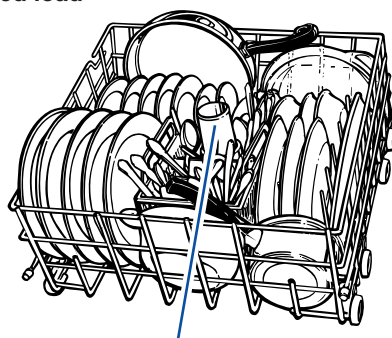

Do not cover spray tower

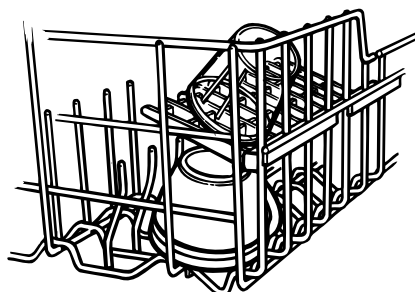

Loading the bottom rack

Items with cooked-on or dried-on food should be loaded in the bottom rack, with soiled surfaces facing inward to the spray.

Mixed load

- Make sure pot handles and other items do not stop rotation of the lower spray arm. Spray arm must move freely.
- Load items so they do not block or cover the spray tower.
- Securely place heavily soiled cookware face down in rack.

Dish load

- Place plates, soup bowls, etc., between prongs and facing inward to the spray.
- Do not place items directly over spray tower.

Mixed load

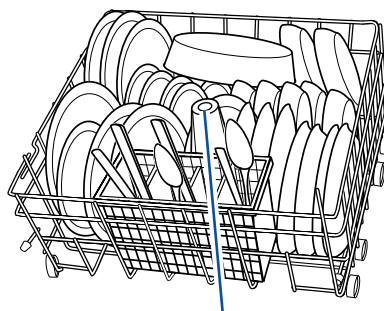

Do not cover spray tower

Utensil load

- Load cookie sheets, cake pans, and other large items at sides and back. Loading such items in front may keep water spray from reaching detergent dispenser.

NOTE:

- Do not load glasses, cups, or plastic items in the bottom rack.
- When lower rack is removed, replace with bumpers in front.
- Do not load items between the bottom rack and the side of the dishwasher tub. This can block the water inlet opening.

Utensil load

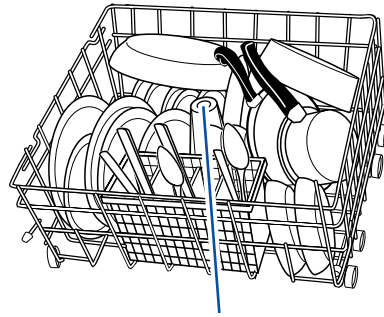

Do not cover spray tower

Loading the silverware basket

- Load the silverware basket while in the bottom rack or take the basket out for loading on a counter or table.

NOTE: The loaded basket must be placed in the center front of the bottom rack for proper washing.

Some of the load may not be completely washed if the loaded silverware basket is placed in a different location.

- The basket can also be removed for easy unloading. Always unload or remove the basket before unloading the racks to avoid spilling water droplets on the silverware.
- Mix items in each section of the basket with some pointing up and some down to avoid nesting. Spray cannot reach nested items.
- **IMPORTANT:** Always load sharp items (knives, skewers, forks, etc.) pointing down.
- Small items (baby bottle caps, jar lids, etc.) can be put in any section.

Style 1

(on some models)



Style 2

(on some models)



Style 3

(on some models)

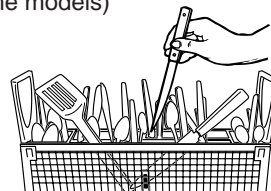

Caring for Your Dishwasher

Your new dishwasher is designed to give you many years of dependable service. There are a few things you can do to maintain your dishwasher properly. This section tells you how to clean and care for your dishwasher. Refer to the “Solving Common Dishwashing Problems” section for special cleaning problems.

Cleaning the exterior

In most cases, regular use of a soft, damp cloth or sponge and a mild detergent is all that is necessary to keep the outside of your dishwasher nice looking and clean.

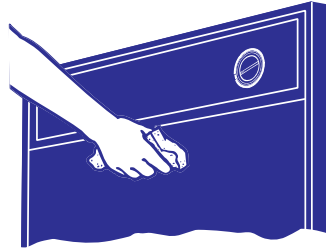

Cleaning the interior

Hard water minerals may cause a white film to build up on the inside surfaces, especially just beneath the door area. To clean interior:

- Apply powdered dishwasher detergent to a damp sponge to make a paste.

OR

- Use liquid automatic dishwasher detergent and clean with damp sponge.

Do not clean the dishwasher interior until it has cooled.

Wear rubber gloves. **Do not** use any type of cleanser other than dishwasher detergent because it may cause foaming or sudsing.

NOTE: See “Removing spots and film” in the “Solving Common Dishwashing Problems” section to clean your dishwasher with white vinegar. Remember, this procedure is intended for occasional use only. Vinegar is an acid. Excessive use can damage your dishwasher.

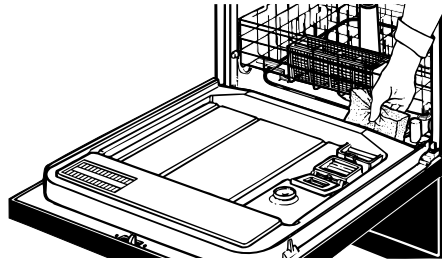

Overfill protector

The overfill protector (in the front right corner of the dishwasher tub) keeps the dishwasher from overfilling. It must be in place for the dishwasher to operate.

Check under the float for objects that may keep the protector from moving up or down.



Cleaning the filter screen

Clean the filter screen when needed.

1. Unload and slide the bottom rack forward. (Remove bottom rack if necessary to reach filter screen.)
2. Remove collected particles from the screen with your fingers or paper towel.
3. Return the bottom rack to original position.

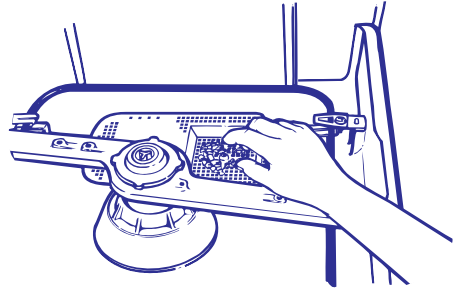

Storing your dishwasher

Moving or winterizing your dishwasher

Protect your dishwasher and home against water damage due to freezing water lines. If your dishwasher is left in a seasonal dwelling or could be exposed to near freezing temperatures, have a qualified person do the following:

NOTE: Pump motor styles vary by model. Refer to Figure 1 or Figure 2, depending on the style of your dishwasher.

1. Disconnect power supply to the dishwasher.
2. Turn off water supply to the dishwasher.
3. Remove the 4 screws on the lower access panel and remove the lower access panel.
4. Place a shallow pan under the water supply valve. Then, use a wrench to disconnect the water inlet from the water supply valve. Separate the water inlet from the water supply valve and drain water into the pan.
5. Remove the spring clamp from the water outlet and separate from the water supply valve; drain water into pan.

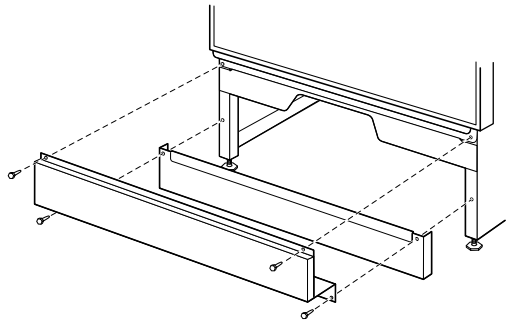
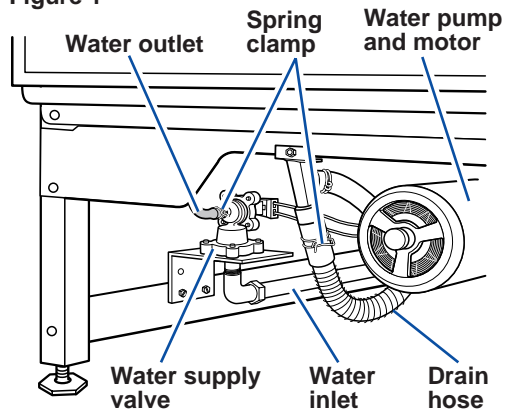

Figure 1



continued on next page

CARING FOR YOUR DISHWASHER

6. Reconnect both water inlet and water outlet to the water supply valve.
7. Empty the pan and reposition it under the water pump.
8. Remove the clamp and disconnect the drain hose from the water pump; drain water into pan.
9. Reconnect drain hose to the water pump, being sure to position the clamp over the connection.
10. Replace the lower access panel.

NOTE: If your dishwasher is connected to a garbage disposal, do not run water into the sink after winterizing. This could cause water to refill the drain hose on your dishwasher.

Reconnecting your dishwasher

1. Remove the 4 screws on the lower access panel and remove lower access panel.
2. Turn on the water supply to dishwasher.
3. Turn on power supply to dishwasher.
4. Run dishwasher through a complete cycle and check for leaks.
5. Replace lower access panel.

Storing for the summer

Protect your dishwasher during the summer months by turning off the water supply and power supply to the dishwasher.

Figure 2

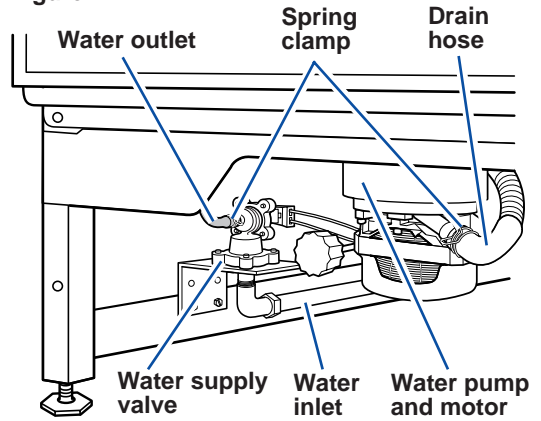

Solving Common Dishwashing Problems

Following is a convenient checklist for handling minor performance problems. Go over this list before calling for service. If you are unable to solve your dishwasher's problem, turn to the "Troubleshooting" section for service information.

Solution chart

PROBLEM	CAUSE	SOLUTION
Food soil left on dishes	Improper loading	Follow loading instructions.
	Water temperature too low	If needed, turn home water heater up to ensure water entering dishwasher is 120°F (49°C) minimum. See the "Energy saving tips" section.
	Use of incorrect, too little, or ineffective detergent	Use recommended dishwasher detergents only. See the "Using the detergent dispenser" section. Never use less than 1 tablespoon per load. Detergent must be fresh to be effective. Always store detergent tightly closed in a cool, dry place.
	Detergent cakes in dispenser	Use only fresh detergent. Do not allow detergent to sit for several hours in a wet dispenser. Check dispenser for caked detergent. Clean dispenser when caked detergent is present.
	Insufficient fill due to low water pressure	Home water pressure should be 20 to 120 pounds per square inch (psi) for proper dishwasher fill. A booster pump on the water supply may be necessary if pressure is too low.
	Slowdown of wash arm due to high suds	Never use soap or laundry detergents. Use only recommended dishwasher detergents.
Spotting and filming	Hard water or high mineral content in water	Use rinse agent to help prevent spotting and filming. See the "Using the detergent dispenser" section. To remove hard water film, see "Removing spots and film" at the end of this section.
	Water temperature too low	If needed, turn home water heater up to ensure water entering dishwasher is 120°F (49°C) minimum.
	Use of incorrect detergents	Use recommended dishwasher detergents only.

continued on next page

SOLVING COMMON DISHWASHING PROBLEMS

PROBLEM	CAUSE	SOLUTION
Spotting and filming (continued)	Incorrect amount of detergent	Follow recommendations for amount. Heavy soil and/or hard water generally require extra detergent.
	Use of ineffective detergents	Use fresh detergent. Store detergent tightly closed in a cool, dry place. Discard lumpy detergent.
	Insufficient fill due to low water pressure	Home water pressure should be 20 to 120 psi for proper dishwasher fill. A booster pump on the water supply may be necessary if pressure is too low.
Dishes do not dry completely	Dishes do not drain properly	Dishes must have proper water drainage. Do not overload. See the "Loading Your Dishwasher" section. Use a liquid rinse agent to speed draining.
	Plastics	Some plastics, due to material, may need to be towel dried.
Silica film or etching (silica film is a white iridescent deposit; etching is a cloudy film)	Water chemical reaction with certain types of glassware – usually caused by some combination of soft or softened water, alkaline washing solutions, insufficient rinsing, overloading the dishwasher, and heat of drying.	It may not be possible to prevent problem, except by hand washing. To slow this process, use a minimum amount of detergent but not less than 1 tablespoon per load. Use a liquid rinse agent and underload the dishwasher to allow thorough rinsing. Silica film and etching are permanent and cannot be removed. Use the No Heat Dry option.
Black or gray marks on dishes	Aluminum items touching dishes	Load aluminum items so that they will not rub against dishes during washing. Do not wash throwaway aluminum items in the dishwasher because they may break down and cause marking. Remove aluminum markings by using a mild abrasive cleanser.
White spots on cookware with non-stick finish	Seasoning removed by dishwasher detergents	Reseason cookware after dishwasher washing.

PROBLEM	CAUSE	SOLUTION
Orange Stains on Dishwasher Interior	Large amounts of tomato-based foods on dishes placed in the dishwasher	Stains may gradually fade over time. Regular use of Heated Dry option may cause stains to fade slower. Stains will not affect dishwasher performance. Regular use of the Rinse Only cycle, with No Heat Dry option for partial loads, will reduce the likelihood of staining.
White Spots on Cookware with Non-Stick Finish	Seasoning removed by dishwasher detergents	Reseason cookware after dishwasher washing.
Odor in the Dishwasher	Dishes only washed every 2-3 days	Run a Rinse Only cycle at least once or twice a day until a full load is accumulated.
Chipping of Dishes	Improper loading	Load dishes and glasses so that they are stable and do not strike together from washing action. Moving racks in and out smoothly will also minimize chipping. NOTE: Some types of china and glassware are too delicate for automatic dishwashing and should be hand-washed; for example: antiques, feather-edged crystal, and similar types.

Removing spots and film

Keep the rinse agent dispenser filled with a liquid rinse agent. A rinse agent prevents water from forming droplets and drying as spots or streaks.

To remove spots and film on dishes and glasses, or hard water film/lime buildup on the interior of the dishwasher, you may use white vinegar with the following procedure:

1. Load clean dishes and glasses in dishwasher. Do not load silverware or other metals in the dishwasher.

2. Put 2 cups of household vinegar (in a glass or dishwasher safe measuring cup) standing upright in the bottom rack.
3. Close and latch the door.
4. Select the Normal Wash cycle and No Heat Dry option. Do not use detergent. Allow the dishwasher to complete the entire cycle.

NOTE: This cleaning procedure is intended for occasional use only. Vinegar is an acid. Excessive use may damage your dishwasher.

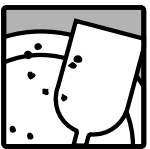

Troubleshooting

Before calling for assistance please check the chart below for problems you can fix. It could save you the cost of a service call.

Dishwasher problems

PROBLEM	CHECK THE FOLLOWING
Dishwasher does not run or stops during a cycle	<p>Is the door tightly closed and securely latched?</p> <p>Has the cycle been set correctly? See the "Using Your Dishwasher" section.</p> <p>Has a household fuse blown or circuit breaker tripped?</p> <p>If the motor stopped because of an overload, it will automatically reset itself within a few minutes. If it does not start, call for service.</p> <p>Is the water supply turned on?</p>
Dishwasher will not fill	<p>Is the overfill protector stuck in "up" position? Overfill protector should move up and down freely. Press down to release. See the "Caring for Your Dishwasher" section.</p>
Water remains in dishwasher	<p>Allow cycle to finish. A small amount of water remaining is normal.</p> <p>Check the drain air gap (if installed). If it is clogged, follow the manufacturer's cleaning instructions.</p>
Detergent remains in covered section of dispenser	<p>Has the cycle completed?</p> <p>Is the detergent fresh and dry without lumps? See the "Using the detergent dispenser" section.</p> <p>Is the bottom rack in backwards? The rack bumpers must face the dishwasher door.</p>
Dishes not as dry as you expected	<p>Is the rinse agent dispenser empty? Using a rinse agent greatly improves drying. See the "Using the detergent dispenser" section.</p> <p>Do not use No Heat Dry option on the next load.</p>
White residue appears on front of access panel	<p>Is too much detergent being used? See the "Using the detergent dispenser" section.</p> <p>Some liquid detergents develop excess foam and residue on panel. Try a different brand to reduce foaming and eliminate buildup.</p>
Dishwasher will not close	<p>Is the bottom rack in backwards? The rack bumpers must face the dishwasher door.</p>

Requesting Assistance or Service

Before calling for assistance or service, please check the "Troubleshooting" section. It may save you the cost of a service call. If you still need help, follow the instructions below.

1. If you need assistance* ...

Call the Whirlpool Consumer Assistance Center telephone number. Dial toll-free from anywhere in the U.S.A.:



1-800-253-1301

and talk with one of our trained consultants. The consultant can instruct you in how to obtain satisfactory operation from your appliance or, if service is necessary, recommend a qualified service company in your area.

If you prefer, write to:

Estate Brand Home Appliances
Consumer Assistance Center
2000 North M-63
Benton Harbor, MI 49022-2692

Please include a daytime phone number in your correspondence.

2. If you need service* ...

Whirlpool has a nationwide network of authorized service companies. Whirlpool service technicians are trained to fulfill the product warranty and provide after-warranty service, anywhere in the United States. To locate the authorized Whirlpool service company in your area, call our Consumer Assistance Center telephone number (see Step 1) or look in your telephone directory Yellow Pages under:



• **APPLIANCE-HOUSEHOLD-MAJOR, SERVICE & REPAIR**

- See: Whirlpool Appliances or Authorized Whirlpool Service
(Example: XYZ Service Co.)

• **WASHING MACHINES & DRYERS, SERVICE & REPAIR**

- See: Whirlpool Appliances or Authorized Whirlpool Service
(Example: XYZ Service Co.)

3. If you need FSP® replacement parts ...

FSP is a registered trademark of Whirlpool Corporation for quality parts. Look for this symbol of quality whenever you need a replacement part for your ESTATE® appliance. FSP replacement parts will fit right and work right, because they are made to the same exacting specifications used to build every new ESTATE appliance.

To locate FSP replacement parts in your area, refer to Step 2 or call the Whirlpool Consumer Assistance Center number in Step 1.

4. If you are not satisfied with how the problem was solved ...

- Contact the Major Appliance Consumer Action Program (MACAP). MACAP is a group of independent consumer experts that voices consumer views at the highest levels of the major appliance industry.
- Contact MACAP only when the dealer, authorized servicer, and Whirlpool have failed to resolve your problem.

Major Appliance Consumer Action Program
20 North Wacker Drive
Chicago, IL 60606

- MACAP will in turn inform us of your action.

* When asking for help or service:

Please provide a detailed description of the problem, your appliance's complete model and serial numbers, and the purchase date. This information will help us respond properly to your request.

Index

This index is alphabetical. Look for the word or phrase you are interested in, then look for the page number.

TOPIC	PAGE	TOPIC	PAGE
BOTTOM RACK	18	OPTIONS	12
CLEANING		OVERFILL PROTECTOR	20
Exterior	20	PARTS/FEATURES	4
Interior	20	RESPONSIBILITIES	
COMMON WASHING PROBLEMS		Owner	2
Solving	23-25	RINSE AGENT	
CYCLE		Using	14
Canceling	10	SAFETY	3
Selecting	11	SERVICE	
DETERGENT	13	Requesting	27
DISHWASHER OPERATION		SILVERWARE BASKET	19
Adding a dish during a cycle	9	SPECIAL ITEMS	
Changing a cycle setting	9	Washing	16
Starting	8	SPOTS/FILM	
DISPENSER		Removing	23-25
Detergent	13	TOP RACK	17-18
Rinse agent	14	TROUBLESHOOTING	26
ENERGY		WARRANTY	32
Saving	15	WATER	
FEATURES/PARTS	4	Checking temperature	15
FILM/SPOTS			
Removing	23-25		
LOADING			
Bottom rack	18		
Preparing to load	17		
Silverware basket	17		
Top rack	17		

ESTATE®

Dishwasher Warranty

LENGTH OF WARRANTY	WHIRLPOOL WILL PAY FOR
FULL ONE-YEAR WARRANTY FROM DATE OF PURCHASE	FSP® replacement parts and repair labor to correct defects in materials or workmanship. Service must be provided by an authorized Whirlpool service company.
FULL TEN-YEAR WARRANTY FROM DATE OF PURCHASE	FSP replacement parts and repair labor for the DURAPERM™ tub and/or inner door should they fail to contain water due to defective materials or workmanship. Service must be provided by an authorized Whirlpool service company.
WHIRLPOOL WILL NOT PAY FOR	
<p>A. Service calls to:</p> <ol style="list-style-type: none"> 1. Correct the installation of your dishwasher. 2. Instruct you how to use your dishwasher. 3. Replace house fuses or correct house wiring or plumbing. <p>B. Repairs when your dishwasher is used in other than normal, single-family household use.</p> <p>C. Pickup and delivery. Your dishwasher is designed to be repaired in the home.</p> <p>D. Damage to your dishwasher caused by accident, misuse, fire, flood, acts of God, or use of products not approved by Whirlpool.</p> <p>E. Repairs to parts or systems caused by unauthorized modifications made to the appliance.</p>	

6/94

WHIRLPOOL CORPORATION SHALL NOT BE LIABLE FOR INCIDENTAL OR CONSEQUENTIAL DAMAGES. Some states do not allow the exclusion or limitation of incidental or consequential damages, so this exclusion or limitation may not apply to you. This warranty gives you specific legal rights, and you may also have other rights which vary from state to state.

Outside the United States, a different warranty may apply. For details, please contact your authorized Whirlpool dealer.

If you need service, first see the "Troubleshooting" section of this book. After checking "Troubleshooting," additional help can be found by checking the "Requesting Assistance or Service" section, or by calling our Consumer Assistance Center telephone number, **1-800-253-1301**, from anywhere in the U.S.A.

Free Manuals Download Website

<http://myh66.com>

<http://usermanuals.us>

<http://www.somanuals.com>

<http://www.4manuals.cc>

<http://www.manual-lib.com>

<http://www.404manual.com>

<http://www.luxmanual.com>

<http://aubethermostatmanual.com>

Golf course search by state

<http://golfingnear.com>

Email search by domain

<http://emailbydomain.com>

Auto manuals search

<http://auto.somanuals.com>

TV manuals search

<http://tv.somanuals.com>