



## Portable Steam Cleaner with Caddy

### OWNER'S MANUAL

Model EP922H

120V., 60 Hz, 1550 Watts

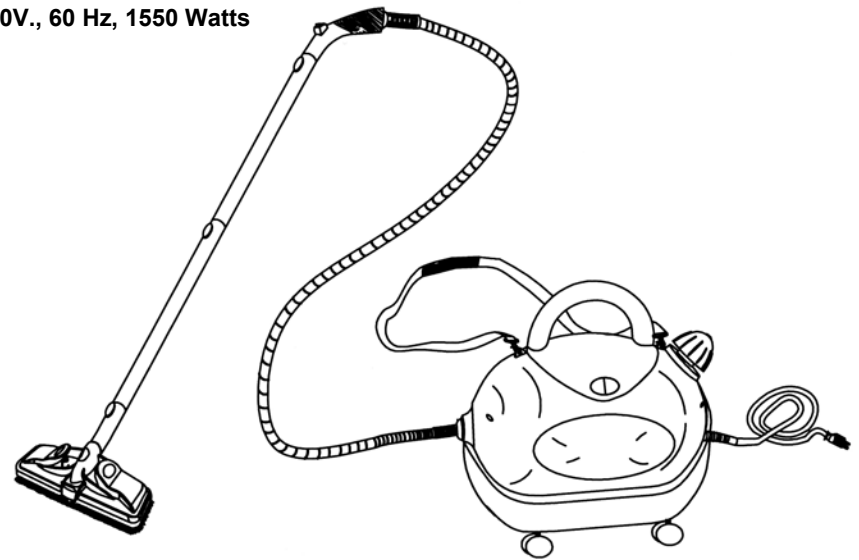

**EURO-PRO Operating LLC**

94 Main Mill Street, Door 16

Plattsburgh, NY 12901

Tel.: 1 (800) 798-7398

# IMPORTANT SAFETY INSTRUCTIONS

When using your **Portable Steam Cleaner with Caddy**, basic safety precautions should always be observed, including the following:

1. Read all instructions before using your steam cleaner.
2. Use the system only for its intended use.
3. To protect against a risk of electric shock, do not immerse any part of the system in water or other liquids.
4. Never yank cord to disconnect from outlet; instead, grasp plug and pull to disconnect.
5. **Do not** allow cord to touch hot surfaces. Let the system cool completely before putting away or opening water tank (removing the safety cap). Wrap cord loosely around system when storing.
6. Always disconnect system from electrical outlet when filling with water or emptying and when not in use. Always turn the safety cap slowly when opening the water tank. This will allow any remaining steam to escape gradually.
7. **Do not** operate the system with a damaged cord or plug, or if the appliance or any other part of the system has been dropped or damaged. To avoid the risk of electric shock, do not disassemble or attempt to repair the steam cleaner. Return the system to **EURO-PRO Operating LLC** (see warranty) for examination and repair. Incorrect re-assembly or repair can cause a risk of electrical shock or injury to persons when the steam cleaner is used.
8. Close supervision is necessary for any appliance being used by or near children. Do not leave the system unattended while connected to electrical outlet or when hot.
9. Burns can occur from touching hot metal parts, hot water or steam. Use caution when draining unit after use as there may be hot water in the unit. Never direct steam at any person. The steam is very hot and can cause burns.
10. **Do not** operate in the presence of explosive and/or flammable fumes.
11. This appliance is intended only for household use. Follow all user instructions in this manual.
12. Never use any chemicals or substance other than tap water in the machine. Use of chemicals may damage the machine. Use of chemicals will automatically void your warranty.

## To reduce the risk of fire, electric shock, or injury:

- **Do not** leave the steam cleaner plugged in when unattended. Unplug the electrical cord when not in use and before servicing or refilling water tank.
- **Do not** allow to be used as a toy. Close attention is necessary when used by or near children, pets or plants.
- Use only as described in this manual. Use only manufacturer's recommended accessories.
- **Do not** pull cord, use cord as a handle, close a door on cord, or pull cord around sharp edges or corners. Keep cord away from heated surfaces.
- **Do not** use extension cords or outlets with inadequate current carrying capacity.
- **Do not** turn off all controls as applicable before unplugging from electrical outlet.
- **Do not** unplug by pulling on cord. To unplug, grasp the plug, not the cord.
- **Do not** handle plug or steam cleaner with wet hands or operate without shoes.
- **Do not** put any objects into openings. Do not use with any opening blocked.
- **ALWAYS STORE YOUR APPLIANCE INDOORS** in a cool, dry area.
- **Do** keep your work area well lit.
- **Do Not turn the appliance over or on its side. Never direct steam towards people, animals or plants.**
- **Do not** immerse the steam cleaner into water or other liquids. Always unplug the power cord from the electrical socket when filling the steam cleaner.
- **Do NOT add cleaning solutions, scented perfumes, oils or any other chemicals to the water used in this appliance as this may damage the unit or make it unsafe for use.** Use tap water or distilled/purified water if the tap water in your area is very hard.

Model EP922H



## 1 YEAR LIMITED WARRANTY

Your Steam Cleaner is warranted to be free from defects in material and workmanship for a period of one (1) year from the date of purchase when utilized for normal household use by the original purchaser only. The included Warranty Registration Card must be filled out and returned within 10 days of purchase. This is essential for your Warranty to be effective should any problem arise with this product.

Should any defect covered by the terms of the limited warranty be discovered within one year, **EURO-PRO Operating LLC** will repair or replace any defective part provided the unit is returned by the original purchaser, freight prepaid, to:

US: **EURO-PRO Operating LLC**, 94 Main Mill Street, Door, 16, Plattsburgh, N.Y. 12901

Proof of purchase date and \$15.95 for handling and return packing/shipping charges must be included.\*

The liability of under this warranty is limited solely to the cost of the replacement parts or the complete unit at our option. **LABOUR CHARGES ARE NOT INCLUDED.**

This warranty does not cover normal wear of parts and does not apply to any unit that has been tampered with or used for commercial purposes. This Limited Warranty does not cover damage caused by misuse, negligent handling, or damage due to faulty packaging or mishandling in transit (by any common carrier).

This warranty is extended to the original purchaser of the unit and excludes all other legal and/or conventional warranties. The responsibility of **EURO-PRO Operating LLC**, if any, is limited to the specific obligations expressly assumed by it under the terms of the limited warranty. In no event is **EURO-PRO Operating LLC** liable for incidental or consequential damages of any nature whatsoever. Some States/Provinces do not permit the exclusion or limitation of incidental or consequential damages, so the above may not apply to you.

This warranty gives you specific legal rights which vary from state to state or province to province.

\*Important: Carefully pack item to avoid damage in shipping. Be sure to attach tag to item before packing with your name, complete address and phone number with note giving purchase information, model number and what you believe is the problem with item. We recommend you insure the package (as damage in shipping is not covered by your warranty). Mark the outside of your package "ATTENTION CUSTOMER SERVICE". **We are constantly striving to improve our products, therefore the specifications contained herein are subject to change without notice.**



## OWNERSHIP REGISTRATION CARD

Please complete and return within ten (10) days of purchase. The registration will enable us to contact you in the event a product defect is discovered. By returning this card you acknowledge to have read and understood the instructions for use, and warnings set forth in the accompanying instructions.

RETURN TO: **EURO-PRO Operating LLC**, 94 Main Mill Street, Door 16, Plattsburgh, N.Y. 12901

PURCHASER: .....

ADDRESS: .....

CITY: ..... STATE: .....

DATE OF PURCHASE: ..... MODEL: **EP922H** .....

NAME AND ADDRESS OF DEALER: .....

# SAVE THESE INSTRUCTIONS

## For Household Use Only

## TIPS ON HOW TO USE YOUR SYSTEM

### Bathroom Areas cont.

To clean sanitary fixtures, use the concentrator with or without detail brush. Use a terry cloth towel or paper towel to wipe up excess moisture and residue.

To clean the sink and faucets, use detail brush then finish by wiping with a towel.

### Automotive

To clean inside your car, use the floor brush with a terry cloth towel attached to clean upholstery and interior areas just as in the home. You should not expose the bristles to leather - use only the brush with the terry cloth towel attached. For detailing the wheels, use the concentrator and the detail brush. Exterior windows are cleaned best by applying the vapor with the concentrator and following with a paper towel. To clean bicycles, use the detail brush. To clean equipment, use the detail brush, depending on the surface area. Finish by wiping down with a towel.

### Artificial Plants

Use the concentrator without a brush attached to blow off the dust and dirt.

### Clothing

A vapor cleaning system is excellent for removing wrinkles from fabrics. Simply "vaporize" the surface from a distance (12"-18") The dry vapor removes wrinkles without leaving the fabric wet like ordinary fabric steamers do.

### Nicotine and Tar

Nicotine and tar dissolves at high temperatures and becomes a light yellow oil that has the consistency of sewing machine oil. When the nicotine/tar film is touched by a hot terry cloth towel clipped over the floor brush, it immediately dissolves and flows into the towel. You can remove it from flat surfaces as fast as you can move the brush over the surface.

### Removing Wax, Tar, Etc.

Many stains are only stuck on the surface of materials and can be easily and quickly removed by "blowing" excess material away from the surface from the side. This is accomplished by using the concentrator. Hold the terry cloth towel to the side to catch the loose residue as it is blown by the concentrator. **Note:** Always vacuum any loose residue off the surface before you apply vapor to it.

### Hints

#### **ALWAYS FINISH CLEANING BY WIPING DOWN THE CLEANED SURFACE WITH A TOWEL**

The portable steam cleaner has many uses that have not been mentioned. This was meant only to give you a general idea of what can be achieved with the unit. However, the ways in which to use the attachments and brushes are in most cases universal. It is **most** helpful to always have a terry cloth towel or paper towel ready to use for removal of moisture and residue. 100% white cotton towels work best. You can clean the brushes with your steam cleaner. To clean the floor brush, hold at one end and use the concentrator to simply blow off dirt into the garbage can. When cleaning the detail brush, use a pair of pliers to hold and blow dirt as above or place in the basket of your dishwasher.

**Note:** Wipe with a towel immediately before the cleaned area dries. When cleaning the oven, use the detail brush to clean around the elements and drip trays. Use the detail brush for cracks, crevices, and hard to reach areas.

**Refrigerator** - Use the concentrator to blow away dirt in the ice machine and on door seals. The vapor will not dry out or crack the seals as chemicals often do. Can openers and other kitchen equipment can be easily cleaned with the detail brush to get into all the nooks and crannies. Mold stains around door gaskets can be removed with the detail brush.

To clean **microwaves** or **other small appliances** use the detail brush for small areas.

**Note:** When cleaning small electrical appliances always unplug them from outlet before cleaning.

To clean **counter tops**, use the floor brush with a terry cloth towel attached. For heavily soiled areas, use the brush without the terry cloth towel first in order to loosen the debris, then follow with a terry cloth towel attached to finish.

## ADDITIONAL IMPORTANT SAFEGUARDS cont.

1. To avoid circuit overload, **do not** operate another appliance on the same socket (circuit) as the steam cleaner.
2. If an extension cord is absolutely necessary, an extension cord rated a minimum of 15 ampere, 14 gage cord should be used. Cords rated for less amperage may overheat. Care should be taken to arrange cord so that it cannot be pulled or tripped over.
3. **Do not** leave unattended when the system is connected to a power supply/electrical outlet.

## SAVE THESE INSTRUCTIONS FOR HOUSEHOLD USE ONLY



**WARNING:** This appliance is equipped with a grounded-type 3-wire cord (3-prong plug). This plug will only fit into an electrical outlet made for a 3-prong plug. This is a safety feature. If the plug should fail to fit the outlet, contact an electrician to replace the outlet. Do not attempt to defeat the safety purpose of the grounding pin, part of the 3-prong plug.



**CAUTION:** Always drain condensed water from hose before use or if unit has been left idle for a period of time. To drain hose, direct nozzle into an appropriate container or sink and depress hand grip steam trigger. Once hose has been drained, normal use may be resumed. Never direct nozzle towards people, animals or plants.

## GETTING TO KNOW YOUR PORTABLE STEAM CLEANER w/CADDY

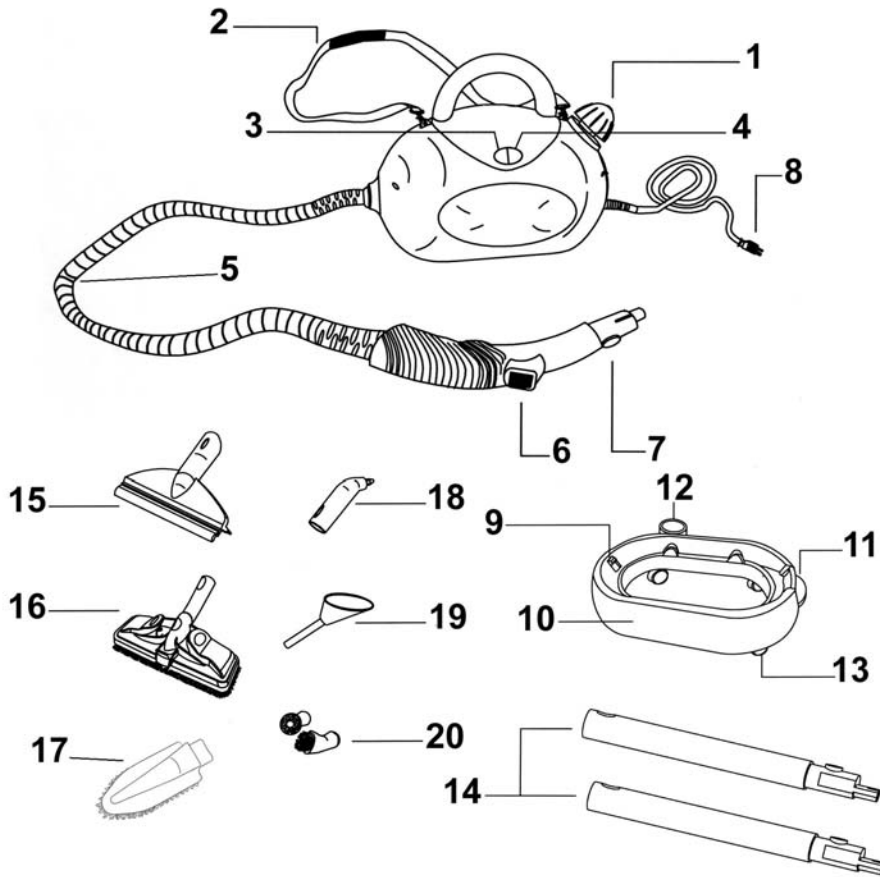

- |                              |                                |
|------------------------------|--------------------------------|
| 1. Safety Filler Cap         | 11. Rear Locking Latch         |
| 2. Shoulder Strap            | 12. Hand Grip Storage          |
| 3. Power "On" Light (Red)    | 13. Castors (x4)               |
| 4. Steam Ready Light (Green) | 14. Extension Tubes (x2)       |
| 5. Flexible Hose             | 15. Window Squeegee            |
| 6. Steam Switch              | 16. Floor Brush                |
| 7. Locking Button            | 17. Triangular Brush           |
| 8. Power Cord                | 18. Concentrator               |
| 9. Front Locking Tab         | 19. Funnel                     |
| 10. Caddy                    | 20. Nylon Bristle Brushes (x2) |

### Technical Specifications

Voltage:	120V., 60Hz.
Power:	1550 Watts
Water Capacity:	40 US Fl. Oz. (1200 ml.)
Steam Generator:	Stainless Steel

## TIPS ON HOW TO USE YOUR SYSTEM

### Spot Cleaning (Carpets)

Use the concentrator with or without the detail brush. Move slowly over the soiled area, allowing the steam to penetrate. Agitate with detail brush or clean towel. Dab the spot with the towel (do not rub). Repeat as necessary to remove stain. Vacuum only after the carpet has completely dried.

Always test color fastness of carpet in an inconspicuous area before cleaning.

If your portable steam cleaner fails to remove stubborn stains a commercially available carpet shampoo may be required.

**Do NOT** add cleaning solutions, scented perfumes, oils or any other chemicals to the water used in this appliance as this may damage the unit or make it unsafe for use.

### Upholstery

Use the floor brush attached directly to the hand grip with a clean white terry cloth towel. Use fast, light strokes, avoid getting the fabric wet. Be patient with stubborn spots; work on a spot gently for no more than a minute at a time, then wait five minutes for the area to dry and repeat. Use circular movements or back-and-forth and side-to-side movements to get all sides of surface fibers then blot with a towel. Finish with a brushing in one direction that will give the fabric a uniform appearance.

**CAUTION:** Always determine the color-fastness of any fabric—especially with reds or blues - by taking a clean, moist, warm towel and gently rubbing a small area as far down on the back or other out of the way place on the furniture as possible. If color comes off on the towel, you may need to have the piece dry cleaned.

### Window, Glass Surfaces and Mirrors

Use the dual edge glass and tile squeegee. Work with the vapor jet on using the top to bottom movements. Use the squeegee with the vapor off to clear the water from the glass. To do this without leaving streaks, use lateral movements from the top to the bottom of the surface.

### Fiberglass or Stainless Steel Surfaces

Use the floor brush or detail brush. Slowly move the brush over the surface to be cleaned. The vapor will emulsify the dirt and grease on the surface. Follow behind with a terry cloth towel over the brush to remove excess moisture and residue.

**Tip:** An old idea for polishing stainless steel is to wipe it down with seltzer soda water after it is cleaned.

### Soap Scum

Soap scum dissolves almost immediately under a combination of heat and moisture. Rinse the surface with a small amount of water afterwards or go back over it once more with a clean terry cloth towel.

**Note:** Soap scum sometimes will develop a hard surface from waterborne minerals. If this is the case, use the floor brush with no towel first to break up this surface - or spray or wipe first with lemon, vinegar or seltzer soda water to soften the minerals. Moving too slowly can dry out the soap scum and cause it to granulate on the surface. The surface will have a gritty feel. If this happens, apply vapor to the surface with the open brush again and re-clean.

### Garden Furniture

Use any of the brushes depending on the surface area. Work quickly when cleaning resin outdoor furniture. Finish by wiping with a towel

### Blinds

Use the detail brush to clean blinds. Move the brush over the surface, allowing enough time for the vapor to penetrate. Work quickly on PVC blinds. Test for color fastness on fabric blinds before using. Finish by wiping with a towel.

### Bathroom Areas

To clean the bathtub or shower area, use the detail brush for grout, shower door tracks, hard to get areas and heavily soiled areas. The dual edge window/tile squeegee will be the most efficient way to clean the rest of the area. Allow plenty of time for the heat to penetrate the surface. This is especially helpful in the shower area if there is tile or grout. Wipe with towel.

Removal of soap scum on tile, grout, and shower doors is also easier with the steam cleaner.

## TIPS ON HOW TO USE YOUR SYSTEM

### Water

- Use tap water for all your cleaning needs.
- However, if you live in an area with hard water, use de-mineralized / distilled water when steaming light colored fabrics to eliminate the possibility of hard water stains.

**IMPORTANT:** Do **NOT** add cleaning solutions, scented perfumes, oils or any other chemicals to the water used in this appliance. **Use tap water or distilled/purified water if the tap water in your area is very hard.**

**⚠ WARNING:** A towel wrapped around the brush can become hot enough to burn. Make sure that you let the towel cool off for 5 minutes before touching it.

### Using Towels

- For best results use 100% cotton white terry cloth towels.
- Use correct size of towel to allow you to wrap the towel around the brushes and clip it under the spring loaded cloth holder.
- The purpose of using a towel is to absorb moisture and dirt being removed. Always use dry towels. A wet towel will smear the dirt.
- Wash towels with strong detergent and bleach.
- Using scented fabric softener while washing the towels will cause the scent to be released into the air when using the towels with your steam system.

### Efficient Work

- For vertical surfaces, wipe with a towel from the top down, in this way the dirty water will not soil surfaces already cleaned.
- Avoid changing brushes back and forth while cleaning.
- Start with the smallest brush to clean tight spots and corners first.
- Use a towel to wipe dirt as soon as possible, otherwise it will dry and re-adhere to the surface.

### Wood, Vinyl and Marble Floors

Use the floor brush with a terry cloth attached. Move the brush across the floor as if you are mopping. When the towel is soiled, allow to cool, then turn the towel over or replace it with a clean towel. If you are working on a very dirty area, you can move the brush over the area slowly, several times. If it is a wood floor, move fast to avoid heat or moisture buildup in the wood. By cleaning with the towel over the brush, you will not affect the shine on the floor.

**To Strip Wax:** Use floor brush for open areas; detail brush for corners or tight areas - no towel, slow strokes. Work a small area at a time - remove the emulsified wax from the floor. When all of the wax has been stripped, immediately clean the floor and brushes with water before residue has a chance to harden on them. Go back over the stripped area with the floor brush with a towel to remove any remaining residue before waxing.

**To Clean Waxed Floors:** Wrap clean towel around the floor brush, brush quickly. This will cause the dirt to be removed but not the wax.

**Vinyl Floors:** Do not allow heat to buildup in any kind of vinyl, since it can soften it enough to affect its texture. Work fast on vinyl.

**Tile Floors:** Use the concentrator with the detail brush attached to an extension. Have the floor brush with cloth attached ready as well. Clean the grout between the tiles with the detail brush. Remove the detail brush and attach the floor brush, move the brush across the floor to clean the tile and remove excess moisture and residue. For areas of tile that are very dirty, remove the towel and agitate with the brush. Do not let the area dry before you wipe with a towel.

## FEATURES OF PORTABLE STEAM CLEANER WITH CADDY

### 1. No more detergents or chemicals. Just add water.



### 2. Lightweight & Portable



### 3. Stainless Steel Boiler: Non-corroding, stainless steel boiler. Welded construction.

### 4. Heavy-duty crush-resistant hose.

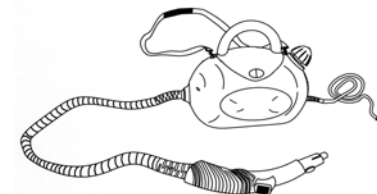

### 5. Versatile, quick-change accessories

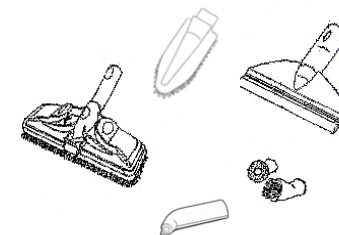

### 6. Indoor and Outdoor Use: Bathrooms, kitchens, living areas, pet areas and appliances. Automotive, patio and windows.

## OPERATING INSTRUCTIONS

### Components

**Power "On" Light (red):** This light will illuminate when the unit is plugged into the 120V. wall outlet. This light will cycle on and off with the steam ready light.

**CAUTION:** Read the instructions for "Filling the Water Tank" before opening the Safety Cap.

**CAUTION:** Always unplug before filling. **ALLOW UNIT TO COOL FOR FIFTEEN (15) MINUTES BEFORE REFILLING.**

**IMPORTANT:** Do **NOT** add cleaning solutions, scented perfumes, oils or any other chemicals to the water used in this appliance. **Use tap water or distilled/purified water if the tap water in your area is very hard.**

### Filling or Refilling Your Steam Cleaner With Water

**IMPORTANT:** Always insure that the unit is "UNPLUGGED" from the wall receptacle prior to initial filling or re-filling the water tank and has been allowed to cool for 15 minutes. **Never attempt to fill this unit under a water tap, always use the filling funnel provided.**

**Step 1:** Before refilling the steam cleaner, make sure that the unit is **NOT** plugged in and has been allowed to cool for fifteen (15) minutes.

**Step 2:** Plug the power cord in to an electrical outlet and press the steam switch on the hand grip to the "ON" position to vent of any residual steam that is in the boiler.

**Step 3:** Remove the power cord from the electrical outlet and turn the steam switch on the hand grip to the "OFF" position.

**Step 4:** Place the unit on a flat, stable surface. Slowly turn the safety filler cap counter clockwise until it is removed.

**Step 5:** Insert the funnel into the tank opening and add 40 US Fl. Oz. (1200 ml) of water. (Fig. 1) Place the funnel in the tank opening as illustrated in Fig. 1. The funnel has been specially designed to show when the water tank is full. When water starts to come out of the vent hole of the funnel, the tank is full.

Remove the funnel slowly and let the remaining water in it to go inside the water tank. **Do Not Overfill.** Replace the Safety Filler Cap.

**WARNING:** Allow unit to cool for 15 minutes before refilling. When refilling the steam cleaner while the boiler is still hot, **there is a risk that water will squirt back during filling and cause scalding. Extreme care should be taken when refilling the unit. Use caution when opening the Safety/Filler Cap as cap may become hot during use and escaping steam can cause scalding.**

**Step 6:** Connect desired attachments onto the Flexible Steam Hose.

**Step 7:** Plug the unit into a standard (120 volt, grounded) wall receptacle. Allow approximately 8-10 minutes for vapor to reach its working temperature and pressure. The green ready light will illuminate when the unit is ready for use. Always point nozzle outlet in a safe direction.

**NOTE:** When the steam cleaner has run out of water, steam output will cease.

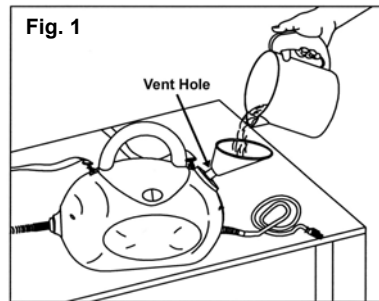

**WARNING:** Allow unit to cool for 15 minutes before refilling. Use caution when opening the Safety/Filler Cap as cap may become hot during use and escaping steam can cause scalding.

## CARE & MAINTENANCE

If you consistently use demineralized or distilled water, cleaning the tank is unnecessary.

### Rinsing Out the Steam Cleaner

Normally, a periodic rinse of your portable steam cleaner will free it from deposits. This is recommended every 10-15 tankfills, to free up any scale deposits from the tank.

Fill the boiler with 20 oz. of water and shake the cleaner vigorously. Tilt the cleaner upside down to empty the boiler of water and any scale deposits.

### Descaling Your Steam Cleaner

If the tap water in your area contains a high level of calcium deposits and you have been using tap water to do your steam cleaning, you should descale your unit after 10-15 tankfills.

### To Descal the Steam Cleaner

**Step 1:** Unplug the steam cleaner from the power source before you descale the boiler. Allow to cool.

**Step 2:** Fill the boiler with 1 part vinegar and 5 parts water and leave overnight or for a period of approximately 8 hours. Do not screw the safety/filler cap onto the steam cleaner while you are descaling the boiler. **Do not use the steam cleaner while descaling solution is inside the boiler.**

**Step 3:** After the period of soaking, turn the steam cleaner upside down to empty solution from the boiler. Due to the fact that a small amount of solution will be left in the boiler, it is necessary to rinse the boiler out with clean water 2 or 3 times. Your steam cleaner is now ready for use.



## OPERATING INSTRUCTIONS

### Attaching the Shoulder Strap

Using the detachable shoulder strap allows for greater freedom of movement when both hands are needed for various cleaning tasks.

To attach the shoulder strap to the steam cleaner, simply snap the shoulder strap hooks onto the connecting rings on the unit body. See Fig. 17, 18 & 19.

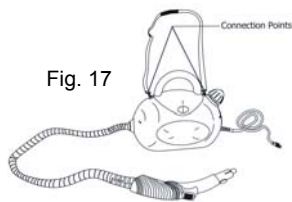

Fig. 17



Fig. 18

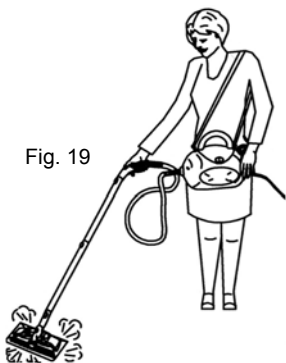

Fig. 19

**IMPORTANT:** When using the portable steam cleaner with the shoulder strap, avoid rocking or tilting the unit excessively as this may cause water to enter the hose and be discharged along with the steam.

### Assembling the Caddy

The casters for the caddy for the portable steam cleaner are packed and shipped unassembled. To assemble the casters to the caddy, simply insert the caster stem into one of the four (4) holes in the base and push downward with the palm of your hand. (Fig. 20.) Repeat for the next three (3) casters.

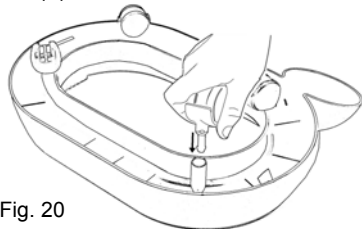

Fig. 20

### Attaching the Portable Steam Cleaner to the Caddy

1. After you have inserted the castors to the base of the caddy, turn the caddy right side up on a flat, level surface. Place it with the rear locking latch to your right.
2. Hold the portable steam cleaner with the power cord also to your right.
3. Insert the left side of the portable steam cleaner (#1 in the illustration below) down into the caddy making sure that it clips into the front locking tab.
4. Then press down on the right side of the portable steam cleaner (#2 in the illustration below) so that the rear locking latch locks in place. (Fig. 21)

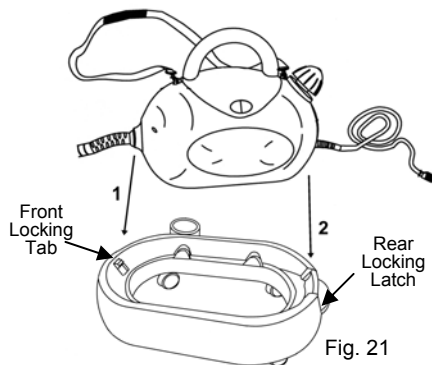

Fig. 21

## OPERATING INSTRUCTIONS

### Using Your Steam Cleaner with Floor Brush

**Step 1:** Connect one of the extension tubes to the hand grip on the flexible steam hose. To attach the extension tubes one onto the other or onto the hand grip, press the locking button ensuring that it fits into the hole. (Fig. 2, Fig. 3) To disconnect, repeat the operation by pressing the locking button and pulling the two sections apart.

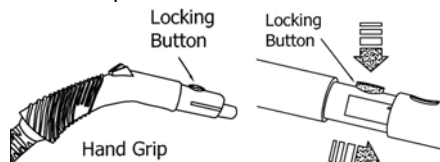

Fig. 2

Fig. 3

**NOTE:** Fit floor brush with the angle adapter on to the extension tube.

**Step 2:** If the angle adapter is not attached to the floor brush, hold the brush with its bristles up in your left hand. With the angle adapter pointing downward, insert it into the hole in the back of the brush, then turn the floor brush 180°.

**Step 3:** Insert the electrical power cord into the wall outlet. Heating time is approximately 8-10 minutes with cold water. Filling the steam generator with hot water will shorten the heat up time.

### Cleaning the Floor Brush

To clean the floor brush after you have finished using:

1. Lift the front clip on the floor brush (Fig. 4) and remove the brush.
2. Rinse the bristle brush and the diffuser housing under warm water.
3. Replace bristle brush onto the diffuser housing.



Front Clip

Fig. 4

### Attaching a Towel to the Floor Brush

100% white terry cloth towel can be fitted on this brush, so as to absorb the dirt and protect delicate surfaces.

**Important:** Please note that bristles may break through thin towels. To cut and make your own towels, we recommend that you use one (1) towel 8" x 17" folded in half or two (2) towels 4" x 17" laid one on top of the other be used. This will ensure that the brush bristles do not break through and that the towels will be sufficiently absorbent and retain as much dirt as possible.

**Very Important:** When installing the towels to the floor brush, ensure that the towels do not cover the front and the back of the brush. (See Fig. 9)

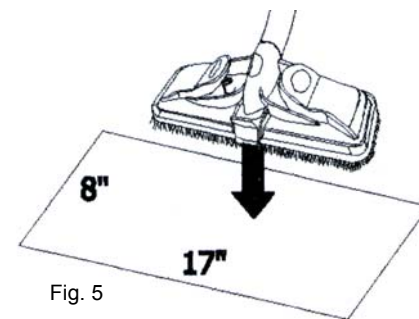

Fig. 5

1. Prepare white terry cloth towel: size 8" x 17" folded in half or place one on top of another to have two layers. (Fig. 5)

2. Place the brush on top of the towel.

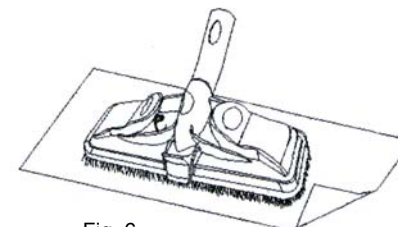

Fig. 6

3. Fold the towel as shown in Fig. 6.

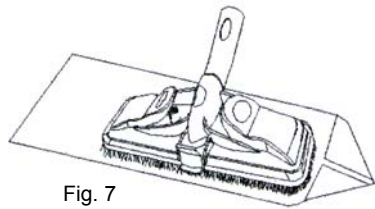

Fig. 7

4. Fold the other side of the towel as shown in Fig. 7.

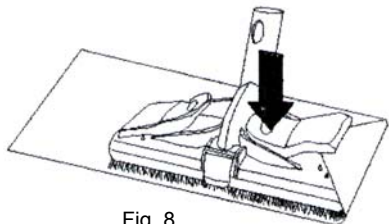

Fig. 8

5. Place the corner under the cloth holder as shown in Fig. 8.

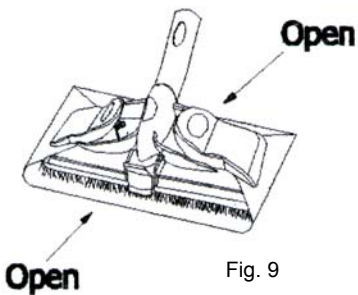

Fig. 9

6. Place the towel around the brush, and repeat folding the towel as shown in Fig. 9. When folding the towel, leave some slack. **Do not** pull tightly around the brush, leave some looseness.

**! WARNING:** Always insure the unit is "UNPLUGGED" from the wall receptacle prior to attaching or removing accessories.

**Using Your Steam Cleaner with Triangular Brush**

To attach the triangular brush to the angle adapter, hold angle adapter in your right hand and the brush in your left. Insert the angle adapter into the triangular brush and turn 180° to lock in place. (Fig. 10)

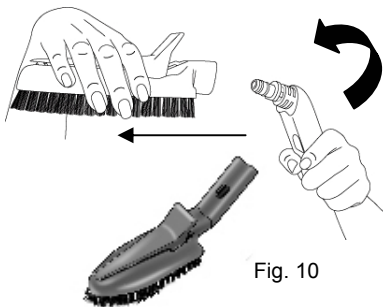

Fig. 10

**Step 1:** The triangle brush w/angle adaptor connects either directly to the handgrip or may be used with the extension tubes. To connect the extension tubes to the hand grip attach the extension tubes one onto the other and then onto the hand grip. (Fig. 11 & 12) To disconnect, reverse the operation by pressing the locking button and pulling the two sections apart.

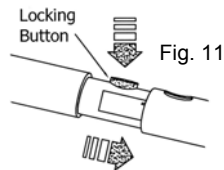
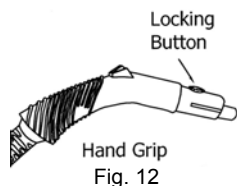

Fig. 11



Hand Grip  
Fig. 12

**Attaching a Towel to the Triangular Brush**

100% white terry cloth towel can be fitted on this brush, so as to absorb the dirt and protect delicate surfaces.

**Important:** Please note that bristles may break through thin towels. We recommend that two (2) towels, laid one on top of the other be used. This will ensure that the brush bristles do not break through and that the towels will be sufficiently absorbent and retain as much dirt as possible.

**Very Important:** When installing the towels to the triangular brush, ensure that the towels do not cover the front and the back of the brush. (See Fig. 16)

Fig. 13

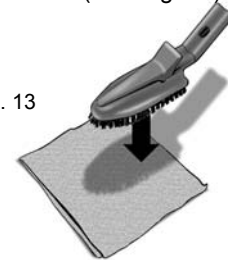

1. Prepare white terry cloth towel: size 8" x 17" as shown in Fig. 13.
2. Place the brush on top of the towel.
3. Fold the towel as shown in Fig. 14



Fig. 14

4. Place the corner under the cloth holder. (Fig. 15)



Fig. 15

5. Fold the other side of the towel in the same way and place the corner under the cloth holder. (Fig. 16)



Fig. 16

**Attaching the Accessories to the Flexible Steam Hose**

**Dual Edge Glass & Tile Squeegee**

This attachment is very useful for cleaning large windows, plastic material, ceramic, tiled or marble surfaces.

To use: Connect the tile squeegee to the hand grip or use with extension tube for hard to reach surfaces.

Apply steam abundantly, rub with the soft spongy edge, then remove excess water and dirt with the glass wiping edge.



**IMPORTANT:** When cleaning windows, always avoid any sudden changes in temperature to prevent glass breakage or cracks.

**Concentrator**

Attach the concentrator to the handgrip or to the extension tubes. Then attach the detail brushes to the concentrator.



**Detail Brush**

It is best for cleaning grout in-between the tiles, ceramic and marble. **To use:** Attach the detail brush on to the end of the concentrator, which then may be used directly on the hand grip or with extension tubes





## Free Manuals Download Website

<http://myh66.com>

<http://usermanuals.us>

<http://www.somanuals.com>

<http://www.4manuals.cc>

<http://www.manual-lib.com>

<http://www.404manual.com>

<http://www.luxmanual.com>

<http://aubethermostatmanual.com>

Golf course search by state

<http://golfingnear.com>

Email search by domain

<http://emailbydomain.com>

Auto manuals search

<http://auto.somanuals.com>

TV manuals search

<http://tv.somanuals.com>