

1 YEAR LIMITED WARRANTY

Your Steam Cleaner is warranted to be free from defects in material and workmanship for a period of one (1) year from the date of purchase when utilized for normal household use by the original purchaser only. The included Warranty Registration Card must be filled out and returned within 10 days of purchase. This is essential for your Warranty to be effective should any problem arise with this product.

Should any defect covered by the terms of the limited warranty be discovered within one year, **EURO-PRO Operating LLC** will repair or replace any defective part provided the unit is returned by the original purchaser, freight prepaid, to:

US: **EURO-PRO Operating LLC**, 94 Main Mill Street, Door 16, Plattsburgh, NY 12901

Proof of purchase date and \$12.95 for handling and return packing/shipping charges must be included.*

The liability of under this warranty is limited solely to the cost of the replacement parts or the complete unit at our option. **LABOUR CHARGES ARE NOT INCLUDED.**

This warranty does not cover normal wear of parts and does not apply to any unit that has been tampered with or used for commercial purposes. This Limited Warranty does not cover damage caused by misuse, negligent handling, or damage due to faulty packaging or mishandling in transit (by any common carrier).

This warranty is extended to the original purchaser of the unit and excludes all other legal and/or conventional warranties. The responsibility of **EURO-PRO Operating LLC**, if any, is limited to the specific obligations expressly assumed by it under the terms of the limited warranty. In no event is **EURO-PRO Operating LLC** liable for incidental or consequential damages of any nature whatsoever. Some States/Provinces do not permit the exclusion or limitation of incidental or consequential damages, so the above may not apply to you.

This warranty gives you specific legal rights which vary from state to state or province to province.

*Important: Carefully pack item to avoid damage in shipping. Be sure to attach tag to item before packing with your name, complete address and phone number with note giving purchase information, model number and what you believe is the problem with item. We recommend you insure the package (as damage in shipping is not covered by your warranty). Mark the outside of your package "ATTENTION CUSTOMER SERVICE". **We are constantly striving to improve our products, therefore the specifications contained herein are subject to change without notice.**



OWNER'S MANUAL
Model SC505
120V., 60Hz., 1550 Watts

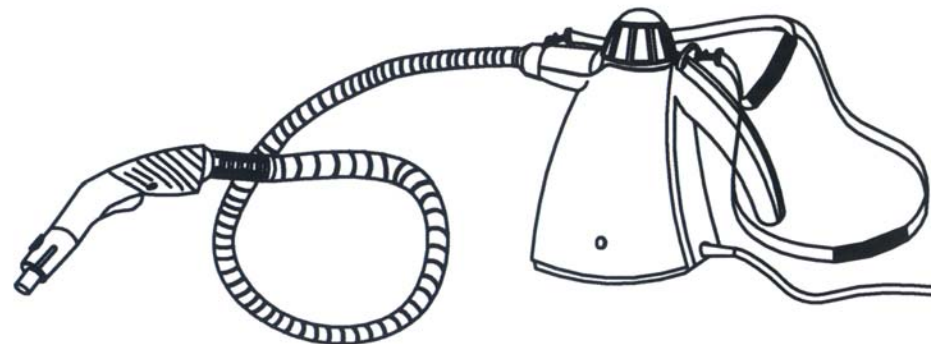

For information or assistance:
EURO-PRO Operating LLC
 94 Main Mill Street, Door 16
 Plattsburgh, NY 12901
 Tel: 1 (800) 798-7398
www.sharkcompany.com

IMPORTANT SAFETY INSTRUCTIONS

When using your **Portable Shark Steam Cleaner**, basic safety precautions should always be observed, including the following:

1. Read all instructions before using your Portable Shark Steam Cleaner.
2. Use the system only for its intended use.
3. To protect against a risk of electric shock, do not immerse any part of the system in water or other liquids.
4. Never yank cord to disconnect from outlet; instead, grasp plug and pull to disconnect.
5. **Do not** allow cord to touch hot surfaces. Let the system cool completely before putting away or before opening the water tank (removing the safety cap). Wrap power cord loosely around your system when storing.
6. Always disconnect system from electrical outlet when filling or emptying water tank and when not in use.
7. **Do not** operate the system with a damaged cord or plug, or if the appliance or any other part of the system has been dropped or damaged. To avoid the risk of electric shock, do not disassemble or attempt to repair the Portable Shark Steam Cleaner. Return the system to **EURO-PRO** (see warranty) for examination and repair. Incorrect re-assembly or repair can cause a risk of electrical shock or injury to persons when the Portable Shark Steam Cleaner is used.
8. Close supervision is necessary for any appliance being used by or near children. Do not leave the system unattended while connected.
9. Burns can occur from touching hot metal parts, hot water or steam. **Do not** turn upside down as there may be hot water in the unit. Never direct steam at any person. The steam is very hot and can cause burns.
10. **Do not** operate in the presence of explosive and/or flammable fumes.
11. This appliance is intended only for household use. Follow all user instructions in this manual.
12. Never use any chemicals or substance other than tap water in the machine. Use of chemicals may damage the machine. Use of chemicals will automatically void your warranty.

To reduce the risk of fire, electric shock, or injury:

- **Do not** leave the Portable Shark Steam Cleaner plugged in when unattended. Unplug the electrical cord when not in use and before servicing or refilling water tank.
- **Do not** allow to be used as a toy. Close attention is necessary when used by or near children, pets or plants.
- Use only as described in this manual. Use only manufacturer's recommended accessories.
- **Do not** pull cord, use cord as a handle, close a door on cord, or pull cord around sharp edges or corners. Keep cord away from heated surfaces.
- **Do not** use extension cords or outlets with inadequate current carrying capacity.
- **Do not** unplug by pulling on cord. To unplug, grasp the plug, not the cord.
- **Do not** handle plug or steam cleaner with wet hands or operate without shoes.
- **Do not** put any objects into openings. Do not use with any opening blocked.
- Store your appliance indoors in a cool, dry area.
- Keep your work area well lit.
- **When in use, never turn the appliance over or on its side. Never direct steam towards people, animals or plants.**
- **Do not** immerse the steam cleaner into water or other liquids. Always unplug the power cord from the electrical socket when filling the steam cleaner.
- **Do NOT add cleaning solutions, scented perfumes, oils or any other chemicals to the water used in this appliance as this may damage the unit or make it unsafe for use.** Use regular tap water or distilled/purified water if the tap water in your area is very hard.
- When using the steam cleaner, please note that the force and the heat of the steam may damage certain surfaces or textiles. Always test on a small, concealed area of the material that you are steam cleaning. i.e. painted wood or leather can be bleached with hot steam; glossy plastic can be dulled, fabrics such as acrylic, velvet and linen can react sensitively to the temperature of the steam.

OPERATING INSTRUCTIONS cont.

Blinds

Use the detail brush to clean blinds. Move the brush over the surface, allowing enough time for the vapor to penetrate. Work quickly on PVC blinds. Test for color fastness on fabric blinds before using.

Refrigerator - Use the angle concentrator/brush adapter alone to blow away dirt in the ice machine and on door seals. The vapor will not dry out or crack the seals as chemicals often do. Can openers and other kitchen equipment can be easily cleaned with the detail brush to get into all the nooks and crannies. To clean **microwaves** or **other small appliances** use the detail brush for small areas.

Note: When cleaning small electrical appliances always unplug them from outlet before cleaning.

Upholstery

Use the floor brush attached directly to the hand grip with a clean white terry cloth towel. Use fast, light strokes, avoid getting the fabric wet. Be patient with stubborn spots; work on a spot gently for no more than a minute at a time, then wait five minutes for the area to dry and repeat. Use circular movements or back-and-forth and side-to-side movements to get all sides of surface fibers. Finish with a brushing in one direction that will give the fabric a uniform appearance.

CAUTION: Always determine the color-fastness of any fabric-especially with reds or blues - by taking a clean, moist, warm towel and gently rubbing a small area as far down on the back or other out of the way place on the furniture as possible. If color comes off on the towel, you may need to have the piece dry cleaned.

Exterior Areas

To clean inside your car, use the floor brush with a terry cloth towel attached to clean upholstery and interior areas just as in the home. You should not expose the bristles to leather - use only the brush with the terry cloth towel attached. For detailing the wheels, use the concentrator nozzle and the detail brush. Exterior windows are cleaned best by applying the vapor with the concentrator nozzle and following with a paper towel.

To clean bicycles, use the detail brush. To clean equipment, use the detail brush, depending on the surface area.

Wood, Vinyl and Marble Floors

Use the floor brush with a terry cloth attached. Move the brush across the floor as if you are mopping. When the towel is soiled, you can turn the towel over or replace it with a clean towel. If you are working on a very dirty area, you can move the brush over the area slowly, several times. If it is a wood floor, move fast to avoid heat or moisture buildup in the wood. By cleaning with the towel over the brush, you will not affect the shine on the floor.

To Strip Wax: Use floor brush for open areas; detail brush for corners or tight areas - no towel, slow strokes. Work a small area at a time - remove the emulsified wax from the floor. When all of the wax has been stripped, immediately clean the floor and brushes with water before residue has a chance to harden on them. Go back over the stripped area with the floor brush with a towel to remove any remaining residue before waxing.

To Clean Waxed Floors: Wrap clean towel around the floor brush, brush quickly. This will cause the dirt to be removed but not the wax.

Vinyl Floors: Do not allow heat to buildup in any kind of vinyl, since it can soften it enough to affect its texture. Work fast on vinyl.

Tile Floors: Use the angle concentrator/brush adapter with the detail brush attached to an extension. Have the floor brush with cloth attached ready as well. Clean the grout between the tiles with the detail brush. Remove the detail brush and attach the floor brush, move the brush across the floor to clean the tile and remove excess moisture and residue. For areas of tile that are very dirty, remove the towel and agitate with the brush. Do not let the area dry before you wipe it up.

Note: When using the steam cleaner, please note that the force and the heat of the steam may damage certain surfaces or textiles. Always test on a small, concealed area of the material that you are steam cleaning. i.e. painted wood or leather can be bleached with hot steam; glossy plastic can be dulled, fabrics such as acrylic, velvet and linen can react sensitively to the temperature of the steam.

SAVE THESE INSTRUCTIONS

For Household Use Only

OPERATING INSTRUCTIONS cont.

Tips On How To Use Your Steam Cleaner

Water

- Use tap water for all your cleaning needs.
- However, if you live in an area with hard water, use demineralized/ distilled water when steaming light colored fabrics to eliminate the possibility of hard water stains.

IMPORTANT: Do **NOT** add cleaning solutions, scented perfumes, oils or any other chemicals to the water used in this appliance. **Use tap water or distilled/purified water if the tap water in your area is very hard.**



Efficient Work

- **For vertical surfaces, wipe always from the top down, in this way the dirty water will not soil surfaces already cleaned.**
- **Avoid changing brushes back and forth while cleaning. Start with the smallest brush to clean tight spots and corners first.**
- **Wipe dirt as soon as possible, otherwise it will dry and re-adhere to the surface.**

Hints

The Portable Shark Steam Cleaner has many uses many of which will not be mentioned in this owner's manual. This is meant only to give you a general idea of what can be achieved with the unit. However, the ways in which to use the units and the brushes are in most cases universal. **It is most helpful to always have a micro fiber cloth or a terry cloth towel or paper towel ready to use for removal of moisture and residue. 100% white cotton towels work best.**

You can clean the brushes with your steam cleaner. When cleaning the detail brush, use a pair of pliers to hold the brush or place in the basket of your dishwasher.

Note: Wipe immediately before the cleaned area dries. When cleaning the oven, use the detail brush to clean around the elements, drip trays, cracks, crevices, and hard to reach areas.

Window, Glass Surfaces and Mirrors

Use the window squeegee. Work with the steam on using top to bottom movements. Use the squeegee with the steam to clear the water from the glass. To do this without leaving streaks, use lateral movements from the top to the bottom of the surface.

Fiberglass or Stainless Steel Surfaces

Use the nylon detail brush. Slowly move the brush over the surface to be cleaned. The steam will emulsify the dirt and grease on the surface. Follow behind with a 100% cotton towel to remove excess moisture and residue.

Tip: An old idea for polishing stainless steel is to wipe it down with seltzer soda water after it is cleaned.

Soap Scum

Soap scum dissolves almost immediately under a combination of heat and moisture. Rinse the surface with a small amount of water afterwards.

Note: Soap scum sometimes will develop a hard surface from waterborne minerals. If this is the case, use the detail brush to break up this surface - or spray or wipe first with lemon, vinegar or seltzer soda water to soften the minerals.

Moving too slowly can dry out the soap scum and cause it to granulate on the surface. The surface will have a gritty feel. If this happens, apply vapor to the surface with the nylon detail brush again and re-clean.

Bathroom Areas

To clean the bathtub or shower area, use the detail brush for grout, shower door tracks, hard to get areas and heavily soiled areas. The window squeegee will be the most efficient way to clean the rest of the area. Allow plenty of time for the heat to penetrate the surface. This is especially helpful in the shower area if there is tile or grout.

To clean sanitary fixtures, use angle concentrator/brush adapter with or without the nylon detail brush.

To clean the sink and faucets, use nylon detail brush.

ADDITIONAL IMPORTANT SAFEGUARDS cont.

1. To avoid circuit overload, **do not** operate another appliance on the same socket (circuit)
2. If an extension cord is absolutely necessary, a 15 ampere 14 gage cord should be used. Cords rated for less amperage may overheat. Care should be taken to arrange cord so that it cannot be pulled or tripped over.
3. **Do not** leave unattended when the system is connected to a power supply/electrical outlet.

SAVE THESE INSTRUCTIONS FOR HOUSEHOLD USE ONLY



WARNING: This appliance is equipped with a grounded-type 3-wire cord (3-prong plug). This plug will only fit into an electrical outlet made for a 3-prong plug. This is a safety feature. If the plug should fail to fit the outlet, contact an electrician to replace the outlet. **Do not attempt to defeat the safety purpose of the grounding pin, part of the 3-prong plug.**

GETTING TO KNOW YOUR PORTABLE SHARK STEAM CLEANER

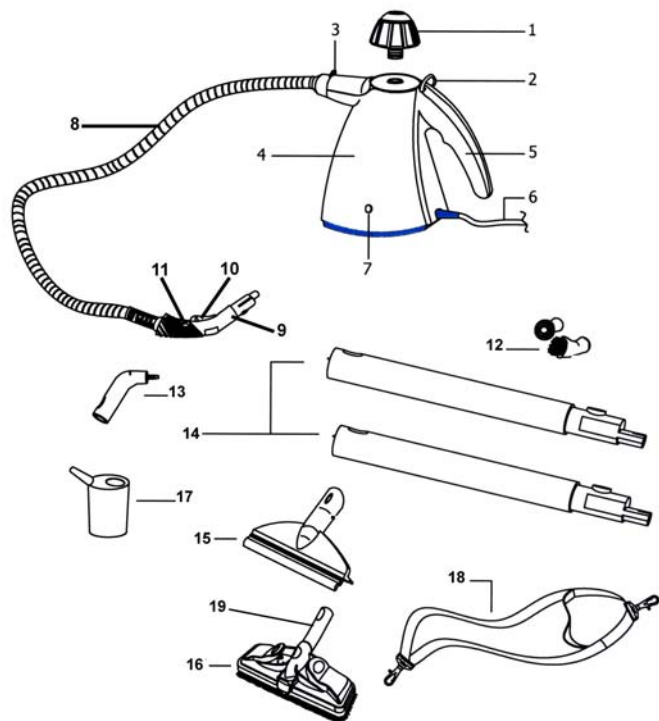

- | | |
|------------------------|--------------------------------------|
| 1. Safety Cap | 11. Trigger Lock |
| 2. Shoulder Strap Hook | 12. Nylon Detail Brush (x2) |
| 3. Shoulder Strap Loop | 13. Angle Concentrator/Brush Adapter |
| 4. Main Unit | 14. Extension Tubes (x2) |
| 5. Handle | 15. Window Squeegee |
| 6. Power Cord | 16. Floor Brush |
| 7. Indicator Light | 17. Filling Flask |
| 8. Flexible Hose | 18. Shoulder Strap |
| 9. Hand Grip | 19. Angle Adapter (Floor Brush) |
| 10. Steam Trigger | |

Technical Specifications

Voltage: 120V., 60Hz.
 Power: 1550 Watts
 Water Capacity: 28 U.S. Fl. Oz.(800ml)

Note: Illustrations may differ from actual unit.

OPERATING INSTRUCTIONS cont.

Care & Maintenance

CAUTION: This appliance must be unplugged from the electrical outlet and allowed to cool down before performing any cleaning or maintenance tasks on the unit.

- Let the appliance cool down completely before cleaning or storing.
- Depress the trigger before opening the safety cap in order to release any residual pressure in the boiler.
- Empty all water from the water tank after each use.
- Store in a dry, cool place.
- A periodic rinse of your steam cleaner will free it from deposits. This is recommended every 10-15 tankfills to free up any scale deposits. Fill the boiler with water and shake vigorously. Tilt the cleaner upside down to empty the boiler of water and any scale deposits.

Cleaning the Angle Concentrator:

Your steamer should not normally require cleaning, however, should you notice a marked decrease in steam output it may be necessary to remove mineral deposit build-up from the angle concentrator orifice. First ensure that there is water in the tank. If tank is empty, fill with water, (we recommend using purified or demineralized water), then re-start unit noting whether steam output is normal. If steam output is still low, follow these cleaning instructions:

1. Unplug steam cleaner from wall outlet.
2. Use a small diameter stiff metal wire such as a straightened metal paperclip and carefully insert the end of the wire into the angle concentrator orifice.
3. Move wire back and forth several times to remove any deposits.
4. Reconnect appliance to power outlet, switch on and note steam output.
5. If steam performance does not improve, repeat steps #1 through #4.

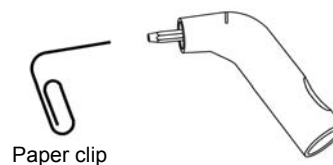

Paper clip

Attaching the Shoulder Strap

Using the detachable shoulder strap allows for greater freedom of movement when both hands are needed for various cleaning tasks. To attach the shoulder strap to the steam cleaner, simply snap the shoulder strap hooks onto the connecting rings on the unit body. When using the steam cleaner with the shoulder strap, avoid rocking or tilting the unit excessively as this may cause water to enter the hose and be discharged along with the steam.

Connecting Points

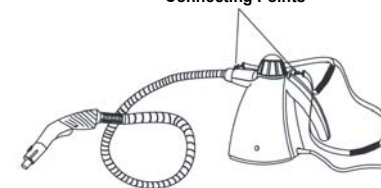

Attaching a Towel to the Floor Brush

100% white terry cloth towel can be fitted on this brush, so as to absorb the dirt and protect delicate surfaces.

Important: Please note that bristles may break through thin towels. We recommend that two (2) towels, laid one on top of the other be used. This will ensure that the brush bristles do not break through and that the towels will be sufficiently absorbent and retain as much dirt as possible.

Very Important: When installing the towels to the floor brush, ensure that the towels do not cover the front and the back of the brush. (See Fig. E)

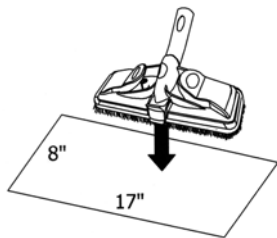

Fig. A

1. Prepare white terry cloth towel: size 8" x 17" as shown in Fig. A.
2. Place the brush on top of the towel.

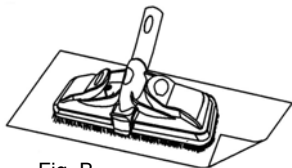

Fig. B

3. Fold the towel as shown in Fig. B

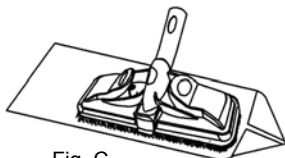

Fig. C

4. Fold the other side of the towel as shown in Fig. C.

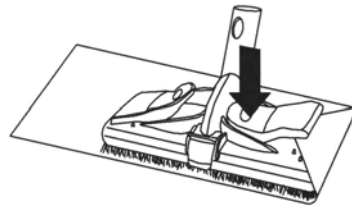

Fig. D

5. Place the corner under the cloth holder as shown in Fig. D.

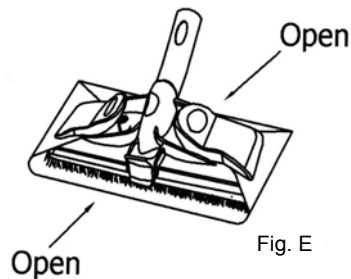

Fig. E

6. Place the towel around the brush, and repeat folding the towel as shown in Fig. E. When folding the towel, leave some slack. **Do not** pull tightly around the brush, leave some looseness.

Your **Hand Held Steam Cleaner** utilizes pressurized steam to remove tough grease, dirt and grime. Steam is nature's purest and most powerful cleaner for safely cleaning all hard surfaces in your home without harsh chemicals, thus being perfectly ecological. The appliance has various attachments so that it can be used for many purposes such as:

1. Clean upholstery, sealed grout, bathroom/kitchen tile, stovetops.
2. Easy to clean difficult to reach areas with the angle concentrator/brush adapter such as faucets, etc.
3. Ideal for windows, mirrors, glass doors, etc.
4. Clean fabrics, window coverings, pillows, bedding etc.
5. Clean hard surface areas such as counters, sinks, shower door tracks, etc.



WARNING: Your Hand Held Steam Cleaner is designed to clean hard surfaces and upholstery that will withstand high heat. Do not use on soft plastics, unsealed wood and cold glass. On surfaces that have been treated with wax or some no wax floors, the sheen may be removed by the heat and steam action. Do not use on unsealed wood. This could cause the wood grain to rise. It is therefore recommended to test an isolated area of the surface to be cleaned before proceeding.



CAUTION: Do not plug in the machine during filling. Use a grounded receptacle. Use only a heavy duty extension cord rated for 15 amps - Do not use an ordinary extension cord.

IMPORTANT:

Do **NOT** add cleaning solutions, scented perfumes, oils or any other chemicals to the water used in this appliance. **Use regular water or distilled/purified water if the tap water in your area is very hard.**

NOTE: There may be a slight release of pressure when accessories are removed. This is normal due to pressure build up inside of accessories during use.

To refill, unplug, unit from electrical outlet, depress trigger until all remaining pressure/steam has been allowed to escape from the tank, and allow to cool for 5 minutes. Carefully open the safety cap. Once cool, refill, replace safety cap and re-plug into electrical outlet. Resume work.

OPERATING INSTRUCTIONS

How To Assemble & Use

IMPORTANT: Always insure that the unit is "UNPLUGGED" from the wall receptacle prior to initial filling or re-filling the water tank. **Never attempt to fill this unit under a water tap, always use the filling flask provided.** Failure to follow these steps will cause the water tank to overflow and may pose an electrical safety hazard.

- Step 1: Before filling the steam cleaner, make sure that the unit is NOT plugged in.
- Step 2: Press locking trigger to ensure all internal pressure is released.
- Step 3: Turn Safety Cap counter clockwise until removed.
- Step 4: Release locking trigger.
- Step 5: Add 28 fl. oz (800 cc) of water using the filling flask provided. **Do not overfill.** Replace Safety Cap by turning clockwise - press down firmly to tighten. Heating time is approximately 6 minutes. Filling the boiler with hot water will shorten heat up time.
- Step 6: Plug the unit into a standard 120 volt grounded wall receptacle. The power "On" light (Red) will light up.
- Step 7: Allow approximately 6 minutes for water vapor to reach its working temperature and pressure. When unit is ready for use the red light will change to Green.
- Step 8: At the start, some water will come out from the nozzle. This is normal.

NOTE: Disconnect steam cleaner from wall outlet before refilling. It is time to refill your steam cleaner when there is no more steam coming out of the nozzle. Because the water tank is pressurized, use caution when opening to refill. Depress the trigger button while you unscrew the safety cap counterclockwise. Always let unit cool for 5 minutes before refilling the unit with water.

CAUTION: When refilling the appliance while it is still hot, the first drops of water might bubble up.

Using the Locking Trigger Button

The steam cleaner has a locking trigger button. The trigger will lock when you have pushed it in all the way. To unlock the steam trigger, just press the locking trigger button in and the steam trigger will pop up, stopping the flow of steam.

Refilling With Water

- Step 1: Disconnect electrical power cord from wall outlet.
- Step 2: Press trigger button until all pressure has been released.
- Step 3: Allow the unit to cool for approximately 5 minutes before refilling with water. Carefully unscrew safety cap.
- Step 4: Slowly pour water using the filling flask into the boiler. **DO NOT Fill Under a faucet, use the filling flask provided. DO NOT OVERFILL. Always leave approximately 2 1/2 inches between the top of the unit and the water level.**
- Step 5: Release the locking trigger.
- Step 6: Screw safety cap back on the appliance and plug appliance back into wall outlet. Steam will start to be produced as before.

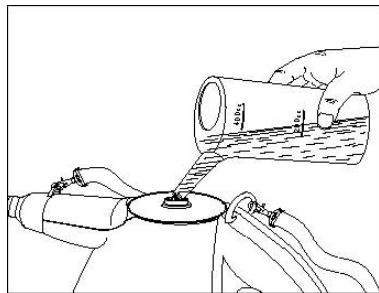

WARNING: This appliance is under pressure. After every use, press trigger button until all pressure has been released before removing safety cap. Allow unit to cool for five (5) minutes before refilling.

OPERATING INSTRUCTIONS cont.

ATTACHMENTS

Angle Concentrator/Brush Adapter

To attach the angle concentrator/brush adapter to the hose, hold the hold grip in one hand and insert the angle concentrator/brush adapter into the nozzle end of the hand grip. Make sure that it locks in place. (See below.)

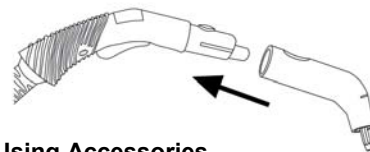

Using Accessories

To use the nylon detail brushes, attach the nylon bristle brush to the end of the angle concentrator/brush adapter. (See below.)

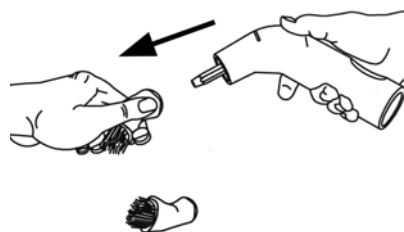

Window Squeegee

CAUTION: When cleaning windows, always avoid any sudden changes in temperature to prevent glass breakage or cracks.

Please note that the window squeegee can only be used with the hose. To attach the window squeegee to the hose, push it in until the squeegee locking button clicks in place on the hose.

Apply steam abundantly, rub with the soft spongy end, then remove excess water and dirt with the glass wiping edge. This attachment is very useful for cleaning large windows, plastic material, ceramic, tiled or marble surfaces.



Using the Steam Cleaner with Floor Brush

Step 1: Connect one of the extension tubes to the hand grip on the flexible steam hose. To attach the extension tubes one onto the other or onto the hand grip, press the locking button ensuring that it fits into the hole. (See illustrations.) To disconnect, repeat the operation by pressing the locking button and pulling the two sections apart.

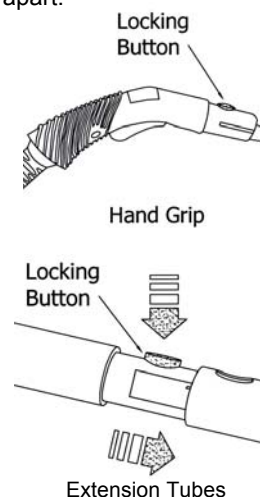

NOTE: Fit floor brush with the floor brush angle adapter on to the Floor Brush Angle Adapter extension tube.

Step 2: If the floor brush angle adapter is not attached to the floor brush, hold the brush with its bristles up in your left hand. With the floor brush angle adapter pointing downward, insert it into the hole in the back of the brush, then turn the floor brush angle adapter 180°.

Step 3: Insert the electrical power cord into the wall outlet. Heating time is approximately 6 minutes with cold water. Filling the steam generator with hot water will shorten heat up time.

Free Manuals Download Website

<http://myh66.com>

<http://usermanuals.us>

<http://www.somanuals.com>

<http://www.4manuals.cc>

<http://www.manual-lib.com>

<http://www.404manual.com>

<http://www.luxmanual.com>

<http://aubethermostatmanual.com>

Golf course search by state

<http://golfingnear.com>

Email search by domain

<http://emailbydomain.com>

Auto manuals search

<http://auto.somanuals.com>

TV manuals search

<http://tv.somanuals.com>