

EURO-PRO 

Food Processor with Blender

Use and Care Instruction Manual
Model EP90E



Read Instruction Manual Before Use

EURO-PRO Operating LLC
94 Main Mill Street, Door 16
Plattsburgh, NY 12901
Tel.: 1 (800) 798-7391
www.euro-pro.com

IMPORTANT SAFEGUARDS

Read Instruction Manual Before Use

When using electrical appliances, basic safety precautions should always be followed, including the following:

1. Read all instructions before using the appliance. It is suggested that you keep these instructions in a safe place for future reference.
2. Your voltage must correspond to the voltage printed on the bottom of the appliance.
3. To protect against electrical shock, do not immerse the motor housing (base), cord, or plug in water or other liquid.
4. Close supervision is necessary when the appliance is used by or near children.
5. Unplug appliance from outlet when not in use, before putting on or taking off parts and before cleaning.
6. Avoid touching moving parts at all times.
7. Do not operate the appliance with a damaged cord or plug, or after the appliance malfunctions, has been dropped or damaged in any manner. Return the appliance to EURO-PRO Operating LLC for examination, repair, electrical or mechanical adjustment.
8. The use of attachments including canning jars not recommended by the manufacturer may cause fire, electric shock or injury to persons.
9. Do not use outdoors.
10. Do not let cord hang over edge of table or counter or touch hot surfaces.
11. Keep hands and utensils away from moving blades or discs while processing food to reduce the risk of severe injury to persons or damage to the food processor. A scraper may be used but must be used only when the food processor is not running.
12. Blades are sharp. Handle carefully. When handling the chopper blade (C) always hold it by the plastic hub.
13. To reduce the risk of injury, never place cutting blades or discs on the base without first putting bowl properly in place.
14. Be certain cover is securely locked in place before operating appliance.
15. Never feed food by hand. Always use food pusher.
16. Do not attempt to by-pass the cover interlock mechanism.
17. Always operate blender with the cover in place.
18. When blending hot liquids, remove center piece of two-piece cover.

IMPORTANT NOTICE

This appliance has a polarized plug (one blade is wider than the other). To reduce the risk of electrical shock, this plug will fit in a polarized outlet only one way. If the plug does not fit fully in the outlet, reverse the plug. If it still does not fit, contact a qualified electrician. Do not modify the plug in any way.

SAVE THESE INSTRUCTIONS

FOR HOUSEHOLD USE ONLY

REV. 10/01C

Congratulations! As the owner of a new Food Processor, you are about to use a very versatile and powerful kitchen appliance that will quickly become an indispensable item in your kitchen. All our products are engineered to meet the highest quality standards and are designed to offer the ultimate in ease of operation and convenience.

IMPORTANT INFORMATION

Please read all the following instructions carefully.

IMPORTANT

For your protection, the Food Processor has a double safety switch so that it cannot run unless the food processor lid (13) is locked in place **and** either the safety cover (2) or the blender (8) is also locked in place.

PLEASE NOTE

- A. To remove safety cover (2) or Blender (8), you must first remove the processor lid (13).
- B. To operate the food processor, the safety cover (2) must be properly locked in place.
- C. To operate the blender (8), processor lid (13) must be locked in place.
- D. When operating blender (8) make sure that all attachments are first removed from the food processor bowl (11).
- E. **Do not attempt to use both blender and food processor at the same time.**
- F. Do not attempt to by-pass the cover (2) safety interlock mechanism or the main lid interlock.

To remove the blender, you must first unlock and remove the processor lid (A). Then unlock and remove the blender (B) by twisting clockwise.

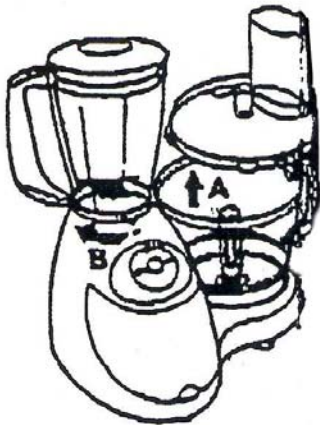

WARNING:

Always remove the blender and fit the safety cover (2) into the processor body when using the processor.

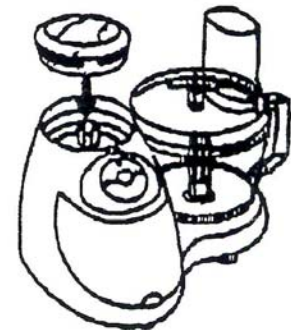

! IMPORTANT: Remove protective chopping blade cover(s) before use. Protective blade covers to only be used for storage.

EURO-PRO X[®]

Food Processor with Blender

Voltage: 120V., 60 Hz

Wattage: 600 Watts

MAIN COMPONENTS AND ACCESSORIES

- | | | |
|----------------------------------|----------------------------|-------------------------------------|
| 1. Processor Body | 12. Spindle | 23. Chopping Blade |
| 2. Safety Cover | 13. Processor Lid | 24. Chopping Blade Protective Cover |
| 3. Safety Cover/Blender Location | 14. Food Pusher | 25. Plastic Dough Blade |
| 4. On/Off Speed Control Dial | 15. Storage Dome | 26. Whisk Head |
| 5. Pulse Button | 16. Spatula | 27. Whisk Beater |
| 6. Drive Shaft | 17. Blade Holder | 28. Juice Extractor/Filter |
| 7. Storage Compartment | 18. Fine Shredding Blade | 29. Juice Extractor Lid |
| 8. Blender | 19. Coarse Shredding Blade | 30. Juice Extractor Pusher |
| 9. Blender Lid | 20. Coarse Slicing Blade | 31. Citrus Juice Filter |
| 10. Measuring Cap | 21. Fine Slicing Blade | 32. Juice Reamer |
| 11. Processor Bowl | 22. French Fry Blade | |

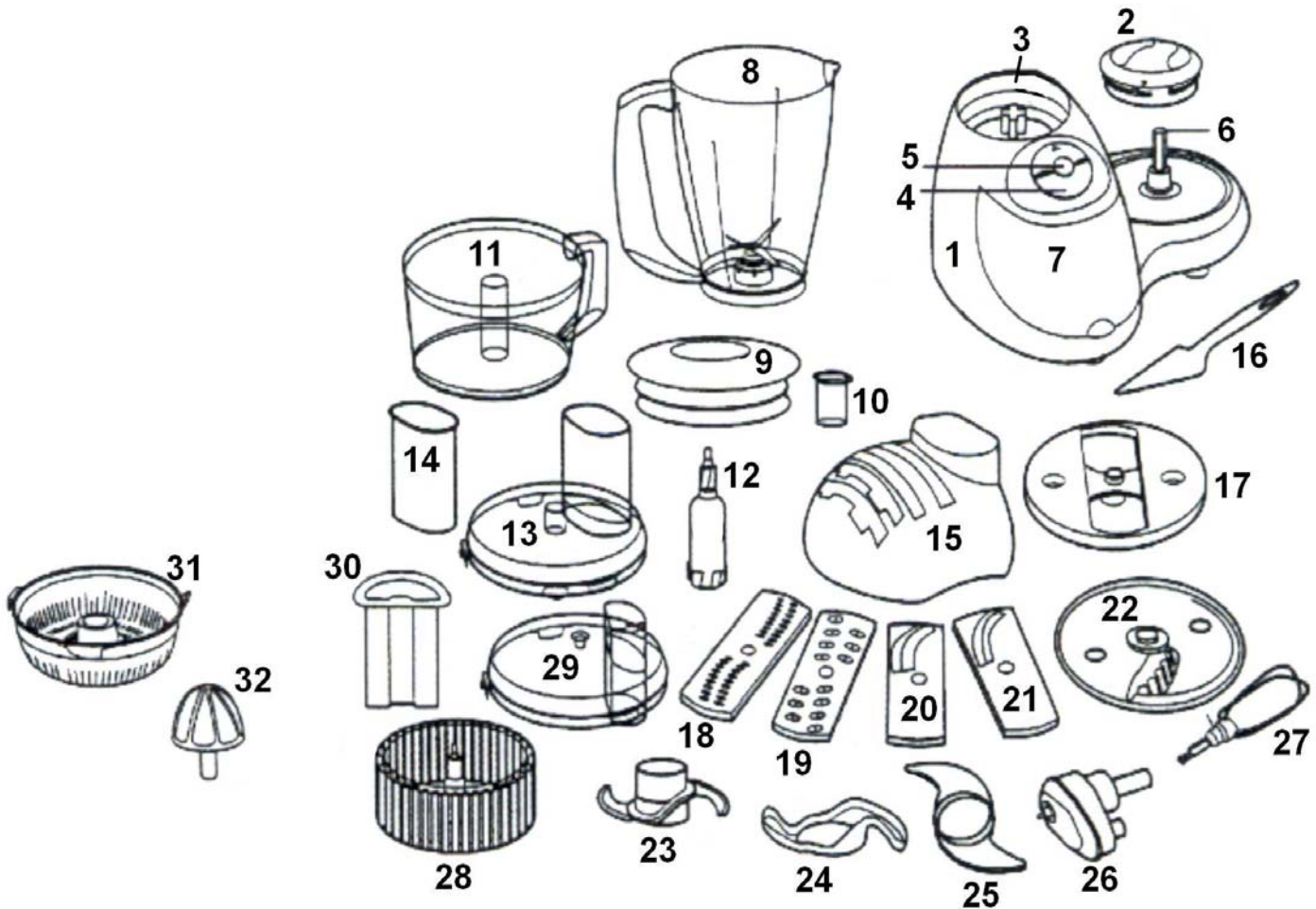

STORAGE

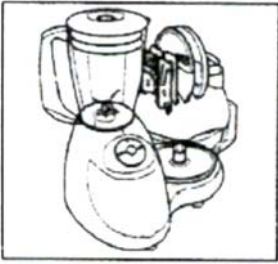

The food processor is designed so that most of the attachments can be stored on-board.

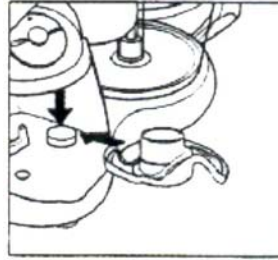

3. Place the protective cover (24) onto the chopping blade (23) and place into storage compartment. The highest part of the blade should be placed at the back of the compartment.

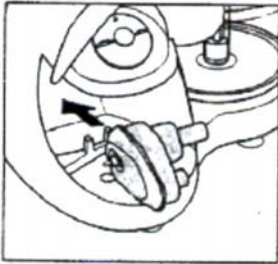

Storage Compartment
1. Lift the lid of the storage compartment (7).
2. Place whisk head (26) in storage compartment as shown.

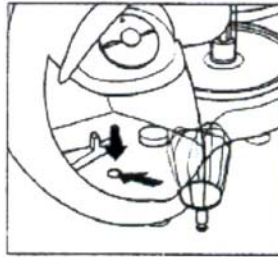

4. Push shaft of whisk beater (27) firmly into the hole.
5. Close the lid of the storage compartment.

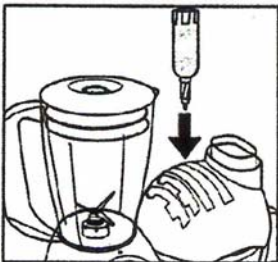

Storage Dome

1. Fit the processor bowl (11) & processor lid (13) onto the processor base.
2. Place the the storage dome (15) onto the processor lid.
3. Add the spindle (12) into the circular hole in the storage dome.

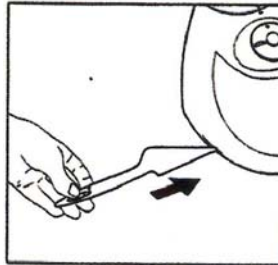

Spatula Storage

Slide the spatula (16) into the slot provided on the side of the processor body (1).



4. Place the plastic blade holder (17) & French fry blade (22) into the two longer slots.



5. Add the slicing blades (20, 21) & the shredding blades (18, 19) into their slots in the storage dome.

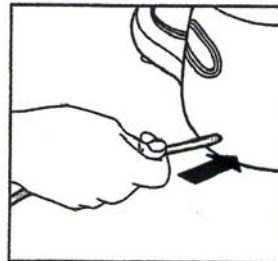

Cord Storage

The power supply cord can be stored by feeding it into the opening at the back of the food processor body.

INSTRUCTIONS FOR USE

Operating Controls

The processor and blender control dials have settings as follows:

Off/1-9 + Max

Pulse

The speed can be adjusted while the processor or blender is in use.

Using the pulse button (5) allows greater control over the texture of the food processed. It is only intended to be used for short "bursts" of processing or blending.

Operating the Food Processor

Setting up

1. **CAUTION:** Make sure that the unit is unplugged from power source and operation button is on "OFF" before inserting or removing any attachments and before cleaning.
2. Fit the safety cover (2) into the food processor body and turn counterclockwise firmly until it "clicks" into place (the arrows will now be lined up). **IMPORTANT: THE FOOD PROCESSOR WILL NOT OPERATE WITHOUT THE SAFETY COVER IN PLACE.**
3. Place the processor bowl (11) onto the processor body (1). There is no need to turn the bowl.
4. When fitted correctly, the handle will be to the right of the assembly, and the ridge on the base of the bowl will fit into the slot at the back of the processor body.

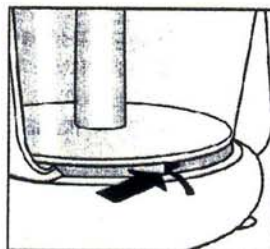
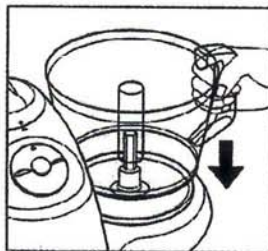
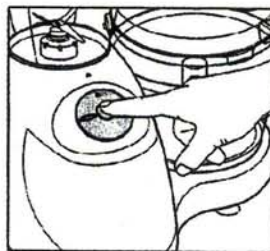
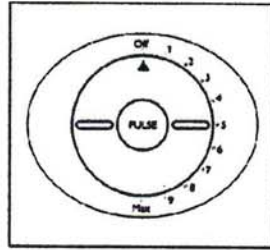

5. Fit the spindle (12) onto the motor shaft (6) and the appropriate attachments onto the spindle. Refer to the following section "Fitting & Using the Tools".

WARNING: TO REDUCE THE RISK OF INJURY, NEVER PLACE THE CUTTING BLADE ON THE BASE WITHOUT FIRST PUTTING THE BOWL PROPERLY IN PLACE.

6. Holding the processor lid (13) by the feed tube, fit the lid by rotating counterclockwise.

7. Ensure that the lid tab has "clicked" into place and the arrows are lined up.

8. Plug the processor and switch on. If the processor does not come on, check that the machine cover and processor lid are both correctly fitted.

FOR SAFETY, ALWAYS USE THE FOOD PUSHER WHEN PUTTING FOOD INTO THE FEEDER TUBE. NEVER FEED BY HAND.

WARNING: ALWAYS REMOVE THE BLENDER AND FIT THE SAFETY COVER (2) INTO THE PROCESSOR BODY WHEN USING THE PROCESSOR.

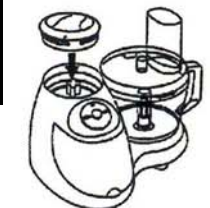
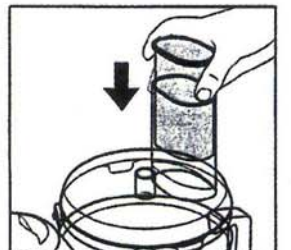
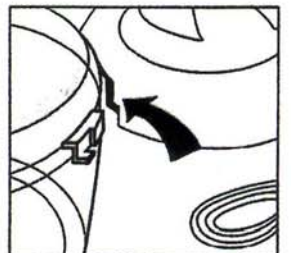
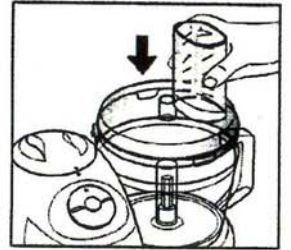
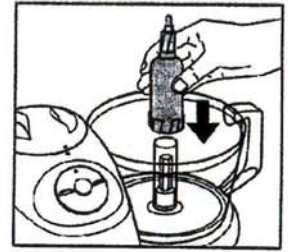

FITTING & USING THE TOOLS

In general, all attachments which are fitted within the processor bowl must be firmly attached to the spindle (12). Always adjust the attachments until you are sure that they are correctly fitted.

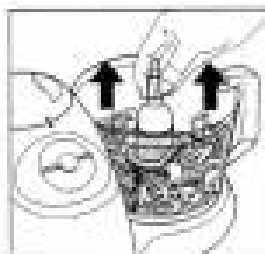
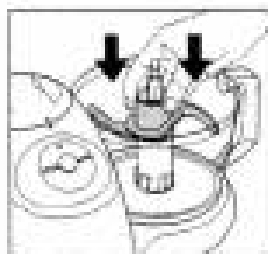

Chopping Blade (23)

1. Fit the processor bowl and spindle as detailed previously.
2. Remove the chopping blade protective cover (24) from the metal chopping blade.
3. Fit the blade over the spindle and press firmly into place.

WARNING:

USE EXTREME CAUTION - BLADES ARE SHARP. ALWAYS HANDLE THE CHOPPING BLADE BY ITS CENTRAL PLASTIC HUB.

4. Place the food into the bowl.
5. Fit the lid and click into place as detailed in the "Setting Up" Section (page 4).
6. Insert power cord into electrical wall outlet.
 - Keep hands and utensils away from cutting blades while chopping food to reduce the risk of injury to persons or damage to the food chopper. A scraper may be used, but must be used only when food processor is not running.
 - Do not leave the appliance unsupervised when it is operating, i.e. when it is "ON".
7. Never feed by hand. Always use the food pusher (14) to push food into the food processor bowl (11) through the feeder tube.
8. **WARNING:** When the processing is completed, unplug, then remove the spindle (12) and blade from the bowl before removing the processed food.
9. **AFTER CLEANING, ALWAYS REPLACE THE PROTECTIVE COVER (24) ON THE METAL CHOPPING BLADE (23).**

Processing Examples With the Chopping Blade:

The processing times indicated below are approximate and also depend on the quantity of the food to be processed and the degree of fineness you require.

PRODUCT	QUANTITY	RECOMMENDED SPEED	OPERATION TIMES
Meat*	24.5 oz / 700 gr.	Max.	15 - 30 seconds
Onions	24.5 oz / 700 gr.	5-6	15 - 30 seconds
Nuts	21 oz / 600 gr.	8-Max.	15 - 30 seconds
Fish*	24.5 oz / 700 gr.	1-8	15 - 30 seconds
Cheese	24.5 oz / 700 gr.	1-8	15 - 30 seconds
Liquids (soups)	24.5 oz / 700 gr.	1-8	20 seconds
Carrots	24.5 oz / 700 gr.	6-8	40-50 seconds
Bread	4 slices	6-8	40 - 50 seconds
Apples	24.5 oz / 700 gr.	8-Max.	10 - 30 seconds
Parsley	Max 4 bundles	Max.	10 seconds
Mayonnaise	Max 4 cups/1 liter	8-Max.	30 seconds

* Always allow food to cool before placing in the bowl.

* Remove all bones before processing.

Plastic Dough Blade (25)

CAUTION: Make sure that the unit is unplugged from the power source and the operating button is “OFF” before inserting or removing attachments.

1. Fit the processor bowl and spindle as described previously on page 4.
2. Fit the plastic dough blade over the spindle and press firmly into place.
3. Place the ingredients into the bowl.
4. Fit the lid and click into place as described in the “Setting Up” section (page 4).
5. Plug in the processor.
6. Turn the processor on selecting maximum speed. Maximum capacity for processing dough is based on the mixture of 21 oz. (600 g.) of flour and 14 oz. (400 g.) of water in order to obtain 2.2 Lbs. (1 kg.) of dough.
7. Remove the blade from the bowl before removing the dough.

WHEN KNEADING DOUGH, DO NOT OPERATE THE MACHINE LONGER THAN 20 SECONDS. AFTERWARDS WAIT AT LEAST 2 MINUTES BEFORE OPERATING THE MACHINE AGAIN.

FOR SAFETY, ALWAYS LEAVE THE PUSHER IN PLACE WHILE OPERATING THE PROCESSOR.

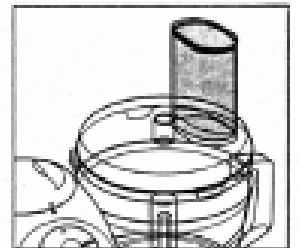
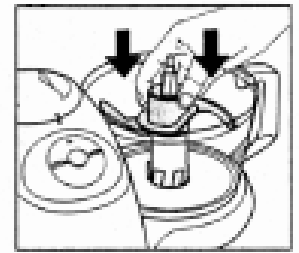

Whisk Head (26) & Whisk Beater (27)

CAUTION: Make sure that the unit is unplugged from the power source and the operating button is “OFF” before inserting or removing attachments.

1. Fit the processor bowl and spindle as described previously on page 4.
2. Click the whisk beater (27) into the short extension of the whisk head (26).
3. Place the long extension of the whisking head onto the motor shaft (6).
4. Add ingredients to the bowl.
5. Fit the lid and click into place as detailed in the “Setting Up” section (page 4).
6. Plug the processor into the wall outlet.
7. Turn the processor on selecting maximum speed.

For your safety, the pusher must stay in its place while operating the appliance. Keep hands, hair, clothing as well as spatulas and other utensils away from beaters during operation to reduce the risk of injury and/or damage to the appliance.

IMPORTANT WARNING: NEVER USE THE WHISK ATTACHMENT FOR DOUGH KNEADING.

DO NOT IMMERSE THE WHISK HEAD (26) IN ANY LIQUID.

To clean the whisk beater (27), remove it from the whisk head (26) and wash.

Wipe the whisk head (26) clean with a damp cloth.

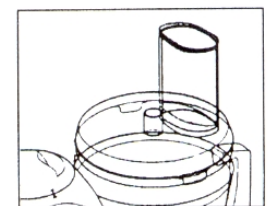
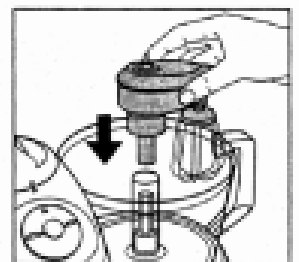
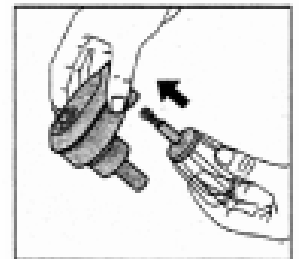

Slicing & Shredding Blades

CAUTION: Make sure that the unit is unplugged from the power source and the operating button is “OFF” before inserting or removing attachments.

1. Place the blade of your choice on the blade holder (17). Inserting the longer tab on the side of the blade first.
2. Press the other end of the blade until it clicks into place.
3. Fit the processor bowl and spindle as detailed on the page 4.
4. Using the finger holes in the blade holder, fit it over the spindle and press firmly into place as indicated.

WARNING: USE EXTREME CAUTION WHEN HANDLING BLADES. BLADES ARE SHARP.

5. Fit the lid and click into place as described in the Setting Up section (page 4).
6. Plug in the processor.
7. **WARNING: USE THE FOOD PUSHER (14) TO ADD FOOD INTO THE PROCESSOR BOWL (11) THROUGH THE FEEDER TUBE.**

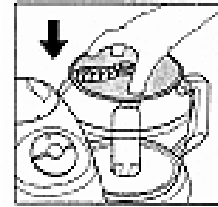
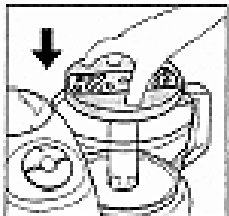
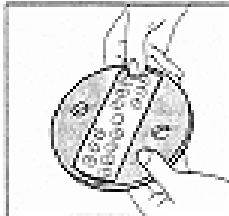

French Fry Blade (22)

1. Fit the processor bowl and spindle as detailed previously.
2. Using the finger holes in the french fry blade, fit it over the spindle and press firmly into place as indicated.

WARNING: USE EXTREME CAUTION WHEN HANDLING BLADES. BLADES ARE SHARP.

3. Fit the lid and click into place as indicated in Setting Up section (page 4).
4. Plug in the processor.
5. **WARNING: USE THE FOOD PUSHER (14) TO ADD FOOD INTO THE PROCESSOR BOWL (11) THROUGH THE FEEDER TUBE.**

Do not overload the bowl. In one operation, you can process maximum 2.2 Lbs. of food.

Processing Examples

- | | |
|-----------------------|---|
| For fine slicing: | Blade A (21) - Recommended speed level is between 5-6 (Cucumbers, raw potatoes, lettuce, carrots) |
| For coarse slicing: | Blade B (20) - Recommended speed level is between 5-6 (Cabbage, carrots, onions) |
| For fine shredding: | Blade C (18) - Recommended speed level is between 5-6 (Carrots, cucumbers, cabbage) |
| For coarse shredding: | Blade D (19) - Recommended speed level is between 5-6 (Lettuce, carrots, apples) |
| For French Fries: | Disc (22) - Recommended speed level is between 5-6 (Potatoes for French Fries) |

Juice Extractor

CAUTION: Make sure that the unit is unplugged from the power source and the operating button is “OFF” before inserting or removing attachments.

1. Fit the processor bowl as detailed previously (page 4).
2. Fit the juice extractor/filter (28) into the processor bowl.
3. Fit the juice extractor lid (29) over the extractor and rotate counter clockwise ensuring that the lid tab has clicked into place.
4. Plug in processor.
5. Turn speed control to low (use only on low speed).
6. Use the juice extractor pusher (30) to add fruit into the food tube.
7. If the juice extractor becomes clogged during use, turn the processor off and remove the pulp from it using the spatula. Be sure to switch the appliance to “OFF” position after each use. Make sure the motor stops completely and unplug the unit before disassembling.

FOR SAFETY, ALWAYS USE THE PUSHER WHEN PUTTING FRUIT INTO THE FEEDER TUBE - NEVER FEED BY HAND.

Do not put your fingers or other objects into the juicer opening while it is operation. If food becomes lodged in the opening, use food pusher or another piece of fruit or vegetable to push it down. When this method of removing food lodged in the opening is not possible, turn the motor off, unplug unit and disassemble juicer to remove the remaining food.

Citrus Juice Filter (31)

WARNING: ALWAYS OPERATE THE JUICER AT LOWEST SPEED ONLY. DO NOT OPERATE THE CITRUS JUICER AT HIGHER SPEEDS.

CAUTION: Make sure that the unit is unplugged from the power source and the operating button is “OFF” before inserting or removing attachments.

1. Fit the processor bowl as detailed previously (page 4).
2. Fit the citrus juice filter (31) into the processor bowl.

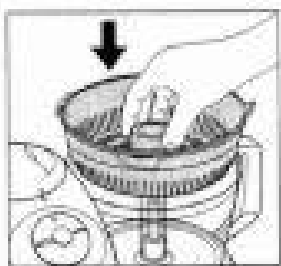

3. Rotate counter clockwise. Ensure that the citrus juice filter tab has clicked into place.

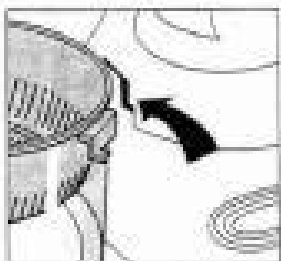

4. Insert the juice reamer into the center of the citrus juice filter (31) with its shaft inside the central column of the bowl.



5. Plug in processor.
6. Place fruit on juice reamer and hold with a cupped hand.
7. Operate at lowest speed.

WARNING: ALWAYS OPERATE THE JUICER AT LOWEST SPEED ONLY. DO NOT OPERATE THE CITRUS JUICER AT HIGHER SPEEDS.

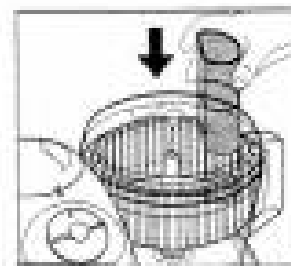
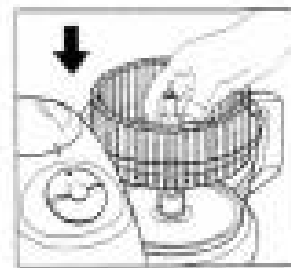

Blender (8)

CAUTION: Make sure that the unit is unplugged from the power source and the operating button is “OFF” before inserting or removing attachments and before cleaning.

1. Remove the processor bowl and lid.
2. Remove the safety cover (2). This can only be done once the processor lid has been removed.
3. Place the blender (8) into its location on the processor body with the handle to the left. Turn counter clockwise until the blender clicks into place and the arrows are aligned.

Warning: Use extreme caution - blades are sharp. Handle carefully.

4. Place food in blender.
5. Place the blender lid (9) and the measuring cap (10) on the blender.
6. Replace the processor bowl and processor lid. Ensure that the lid tab has clicked into place. The blender will not operate if the processor lid is not clicked in place.
7. Plug in the processor.
8. Always operate the blender with the lid in place.

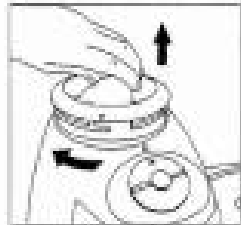
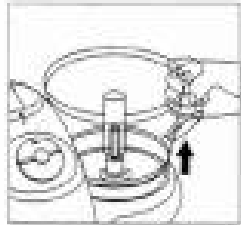

TO REMOVE THE BLENDER, YOU MUST FIRST UNLOCK AND REMOVE THE PROCESSOR LID (A). THEN UNLOCK AND REMOVE THE BLENDER (B) BY TWISTING CLOCKWISE.



WARNING: ALWAYS REMOVE THE BLENDER AND FIT THE SAFETY COVER (2) INTO THE PROCESSOR BODY (1) WHEN USING THE PROCESSOR.



CAUTION: Never operate the blender with more than 42 oz. (1250 ml) of liquid or when empty.

- Recommended speed levels for blending are between 5 - Max.
- Do not overload past the MAX level on the blender.
- You can crush 10 oz. of ice cubes in 15-20 seconds in the blender.
- **To prevent spilling, do not operate the blender with more than 42 oz. (1250 ml) of liquid.**
- **Avoid contact with moving parts at all times.**
- Do not blend boiling liquid.
- To reduce the risk of severe injury to people or damage to the blender, keep hands, hair, clothing as well as spatulas and other utensils out of container while blending.

RE-SETTABLE THERMAL SAFETY DEVICE

Your EP90 Food Processor has been designed with a unique safety system which prevents damage to the unit's motor and drive system, should you inadvertently overload your appliance. The safety system will automatically cut the electric power to the appliance when the device senses an overload or excessive temperature in the motor or drive system. Should this occur during use and the appliance stops functioning, follow the re-setting procedure below:

1. Turn the "ON/OFF" speed control (4) to the "OFF" position
2. Unplug the unit from the wall receptacle.
3. Remove and empty either the blender flask or processor bowl (whichever is being used). Ensure that no food is jamming the cutting blades or attachments.
4. Allow the appliance to cool down for a minimum of 30 minutes.
5. Re-install the processor bowl or blender flask and re-plug appliance in the wall outlet.
6. Proceed to use the appliance as before. Should the appliance still fail to operate, turn the "ON/OFF" speed control (4) to the "OFF" position and unplug from the wall outlet. Allow the appliance to cool down for an additional 1 to 2 hours. After this time has passed, repeat the restart procedure, steps 5 and 6 above.

CLEANING AND MAINTENANCE

CAUTION: Make sure that the unit is unplugged from power source and control button is on “OFF” before inserting or removing any attachments and before cleaning.

- Never immerse the unit, cord or plug in water or any other liquid.
- Clean the motor block with a damp cloth only.
- Only the stainless steel blades can be washed in the dishwasher.
- All other parts can be cleaned in warm sudsy water using regular dishwashing liquid.
- Cleaning the blender jar (flask):
 - *Fill with sudsy warm water.
 - *Place lid on jar.
 - *Run blender at maximum speed for 30 seconds. Rinse and repeat if necessary.

Hints & Tips:

- The metal blade (23) can be used for chopping meat, fish, vegetables, cheese, etc. setting the speed to maximum.
- For finer chopping, increase the length of time you process.
- For coarser chopping, use the pulse button for a few seconds and monitor food texture.
- Pre-cut larger pieces to make them fit into the feed tube. When chopping hard foods (e.g. meat, cheese) cut into 1 “/2.4 cm cubes.
- For shredding, place food horizontally into the feed tube, for slicing place the food vertically.
- When blending, pour the liquids in first and then add the solid food. Begin blending at the lower speed and increase when needed.



ONE (1) YEAR LIMITED WARRANTY

EURO-PRO OPERATING LLC warrants this product to be free from defects in material and workmanship for a period of one (1) year from the date of purchase when utilized for normal household use.

If your appliance fails to operate properly while in use under normal household conditions within the warranty period, return the complete appliance and accessories, freight prepaid. For customer service support, call 1 (800) 798-7398 or visit our web site www.euro-pro.com.

If the appliance is found to be defective in material or workmanship, **EURO-PRO Operating LLC** will repair or replace it free of charge. Proof of purchase date and \$ 9.50 to cover the cost of return shipping and handling must be included.*

The liability of **EURO-PRO Operating LLC** is limited solely to the cost of the repair or replacement of the unit at our option. This warranty does not cover normal wear of parts and does not apply to any unit that has been tampered with or used for commercial purposes. This limited warranty does not cover damage caused by misuse, abuse, negligent handling or damage due to faulty packaging or mishandling in transit.

This warranty is extended to the original purchaser of the unit and excludes all other legal and/or conventional warranties. The responsibility of **EURO-PRO Operating LLC** if any, is limited to the specific obligations expressly assumed by it under the terms of the limited warranty. **In no event is EURO-PRO Operating LLC** liable for incidental or consequential damages of any nature whatsoever. Some states do not permit the exclusion or limitation of incidental or consequential damages, so the above may not apply to you.

This warranty gives you specific legal rights, and you may also have other rights which vary from state to state.

***Important: Carefully pack item to avoid damage in shipping. Be sure to include proof of purchase date and to attach tag to item before packing with your name, complete address and phone number with a note giving purchase information, model number and what you believe is the problem with item. We recommend you insure the package (as damage in shipping is not covered by your warranty). Mark the outside of your package "ATTENTION CUSTOMER SERVICE".**



OWNERSHIP REGISTRATION CARD FOR CANADIAN CONSUMERS ONLY

Please complete and return within ten (10) days of purchase. The registration will enable us to contact you in the event a product defect is discovered. By returning this card you acknowledge to have read and understood the instructions for use, and warnings set forth in the accompanying instructions.

RETURN TO: **EURO-PRO** Operating LLC, 4400 Bois Franc, St. Laurent, QC H4S 1A7

PURCHASER:

ADDRESS:

DATE OF PURCHASE: MODEL: **EP90E** SERIAL NO:

NAME AND ADDRESS OF STORE:

Printed in Turkey

Free Manuals Download Website

<http://myh66.com>

<http://usermanuals.us>

<http://www.somanuals.com>

<http://www.4manuals.cc>

<http://www.manual-lib.com>

<http://www.404manual.com>

<http://www.luxmanual.com>

<http://aubethermostatmanual.com>

Golf course search by state

<http://golfingnear.com>

Email search by domain

<http://emailbydomain.com>

Auto manuals search

<http://auto.somanuals.com>

TV manuals search

<http://tv.somanuals.com>