

# **EURO-PRO**

## **FOOD PROCESSING CENTER**

**OWNER'S MANUAL**

**Model KP81E**

120V., 60Hz., 600 Watts

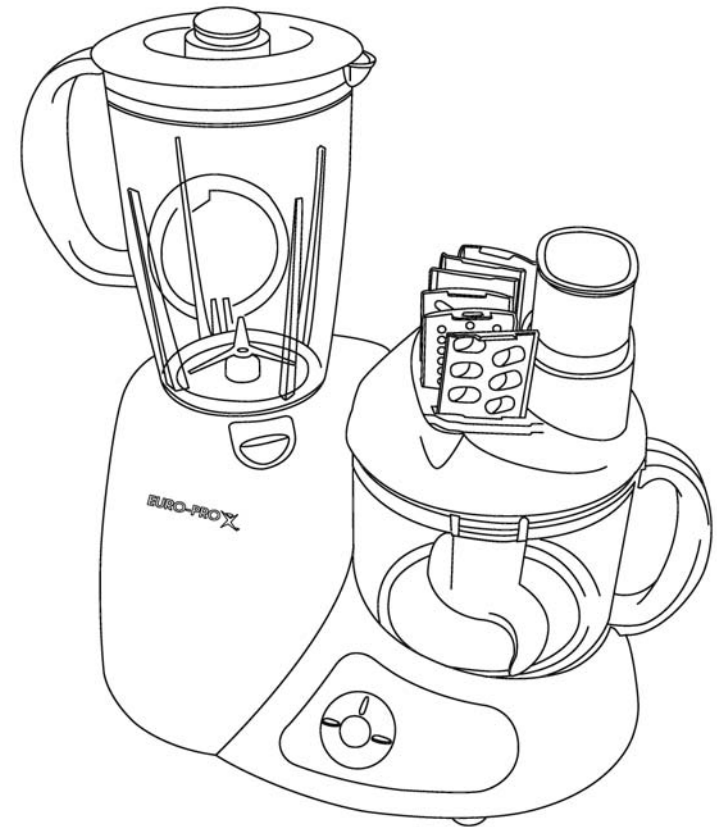

**EURO-PRO Operating LLC**  
Boston, MA, 02465  
1 (800) 798-7398  
[www.euro-pro.com](http://www.euro-pro.com)

# IMPORTANT SAFEGUARDS

## Read Instruction Manual Before Use

When using electrical appliances, basic safety precautions should always be followed, including the following:

1. Read all instructions before using the appliance. It is suggested that you keep these instructions in a safe place for future reference.
2. Your voltage must correspond to the voltage printed on the bottom of the appliance.
3. To protect against electrical shock, do not immerse the motor housing (base), cord, or plug in water or other liquid.
4. Close supervision is necessary when the appliance is used by or near children.
5. Unplug appliance from outlet when not in use, before putting on or taking off parts and before cleaning.
6. Avoid touching moving parts at all times.
7. Do not operate the appliance with a damaged cord or plug, or after the appliance malfunctions, has been dropped or damaged in any manner. Return the appliance to EURO-PRO Corporation for examination, repair, electrical or mechanical adjustment.
8. The use of attachments including canning jars not recommended by the manufacturer may cause fire, electric shock or injury to persons.
9. Do not use outdoors.
10. Do not let cord hang over edge of table or counter or touch hot surfaces.
11. Keep hands and utensils away from moving blades or discs while processing food to reduce the risk of severe injury to persons or damage to the food processor. A scraper may be used but must be used only when the food processor is not running.
12. Blades are sharp. Handle carefully. When handling the chopper blade always hold it by the plastic hub.
13. To reduce the risk of injury, never place cutting blades or discs on the base without first putting bowl properly in place.
14. Be certain cover is securely locked in place before operating appliance.
15. Never feed food by hand. Always use food pusher.
16. Do not attempt to by-pass the cover interlock mechanism.
17. Always operate food processor with the cover in place.
18. Always operate the blender with the cover in place.
19. When blending hot liquids, remove the center piece of the two-piece blender cover.

### IMPORTANT NOTICE

This appliance has a polarized plug (one blade is wider than the other). To reduce the risk of electrical shock, this plug will fit in a polarized outlet only one way. If the plug does not fit fully in the outlet, reverse the plug. If it still does not fit, contact a qualified electrician. Do not modify the plug in any way.

# SAVE THESE INSTRUCTIONS FOR HOUSEHOLD USE ONLY

Congratulations! As the owner of a new Food Processing Center, you are about to use a very versatile and powerful kitchen appliance that will quickly become an indispensable item in your kitchen. EURO-PRO products are engineered to meet the highest quality standards and are designed to offer the ultimate in ease of operation and convenience.

### IMPORTANT INFORMATION

Please read all the following instructions carefully.

### IMPORTANT

For your protection, the Food Processing Center has a double safety switch so that it cannot run unless the food processor lid is locked in place **and** either the safety cover or the blender is also locked in place.

### PLEASE NOTE

- A. To operate the food processor, the safety cover must be properly locked in place.
- B. To operate the blender, processor lid must be locked in place.
- C. When operating blender make sure that all attachments are first removed from the food processor bowl.
- D. **Do not attempt to use both blender and food processor at the same time.**
- E. Do not attempt to by-pass the cover safety interlock mechanism or the main lid interlock.

**WARNING:** Always remove the blender and close the safety cover when using the food processor.

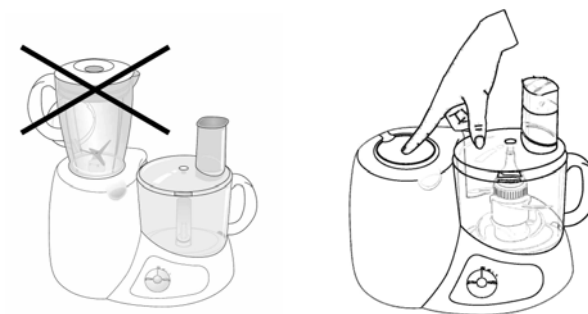

**WARNING:** The food processor bowl must always be in place with the food processor lid in place when using the blender. Please note that **NO** accessory (i.e. blade or attachment) must be inserted inside the food processor bowl when the blender is being used.

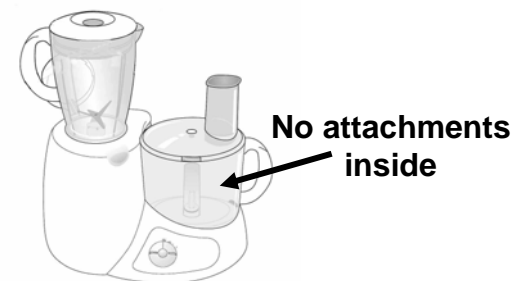

## GETTING TO KNOW YOUR FOOD PROCESSING CENTER

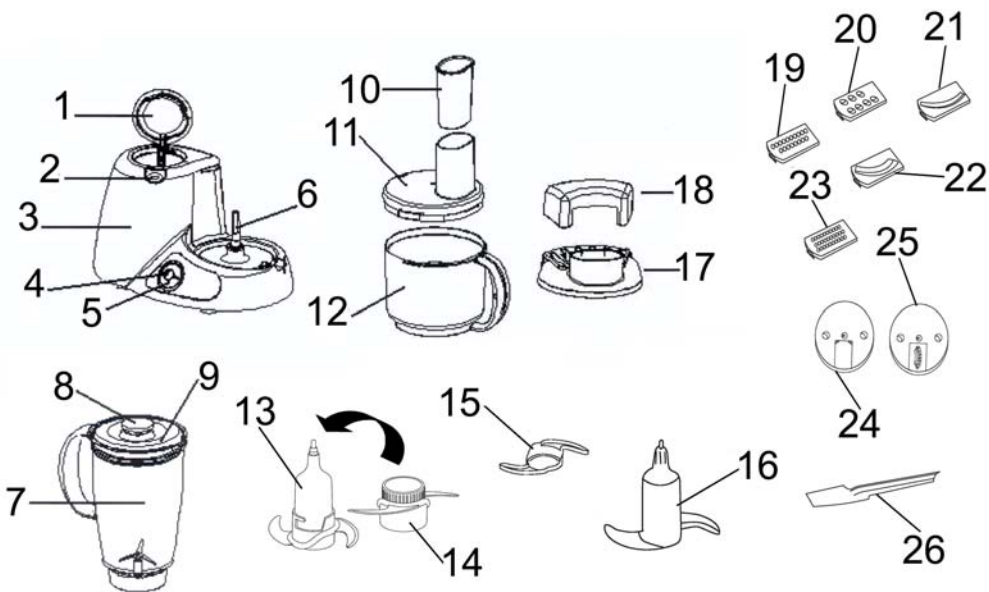

- |                                |                              |
|--------------------------------|------------------------------|
| 1. Safety Cover                | 14. Double Chopping Blade    |
| 2. Safety Cover Release Button | 15. Chopping Blade Cover     |
| 3. Main Unit                   | 16. Dough Blade              |
| 4. Pulse/Turbo Button          | 17. Blade Storage            |
| 5. On/Off Speed Control        | 18. Blade Storage Cover      |
| 6. Spindle                     | 19. Thin Shredding Blade     |
| 7. Blender Jar                 | 20. Thick Shredding Blade    |
| 8. Measuring Cap (1 oz.)       | 21. Thin Slicing Blade       |
| 9. Blender Lid                 | 22. Thick Slicing Blade      |
| 10. Food Pusher                | 23. Grating Blade            |
| 11. Food Processor Lid         | 24. Blade Holder             |
| 12. Food Processor Bowl        | 25. French Fry Disc Assembly |
| 13. Main Chopping Blade        | 26. Spatula                  |

**IMPORTANT:** Remove protective blade cover(s) before use. Protective blade covers to only be used for storage.

## Technical Specifications

Voltage:	120V., 60Hz.
Power:	600 Watts
Food Processor Capacity:	6 Cups (1.5 Liters)
Blender Capacity:	7 Cups (1.75 Liters)

## OPERATING INSTRUCTIONS

### Speed Control Dial

The food processor speed control dial has two speeds settings plus "Pulse" and "Turbo".

- 1 - Low
- 2 - High

The speed can be adjusted while the food processor is in use.

Use of the Pulse/Turbo button allows greater control over the texture of the food being processed. Use "Pulse" when the unit is in the "Off" position. Use "Turbo" when the unit is in the "On" position and you need a burst of power. Please note that the "Pulse" and "Turbo" is only intended to be used for short "bursts" of processing.

### Operating the Food Processor

Setting up:

1. **CAUTION:** Make sure that the unit is unplugged from the power source and the the Speed control dial is in the "Off" position before inserting or removing any attachments and before cleaning.
2. Place the food processor bowl onto the processor body. There is no need to turn the bowl. (Fig. 1)
3. When fitted correctly, the handle will fit into the slot at the base of the unit.



Fig. 1

4. Now you are ready to use any of the attachments that come with the unit; i.e. the double chopping blade, dough blade, etc.

### Using The Double Chopping Blade

**Always disconnect unit from power source before cleaning or changing accessories.**

**WARNING: USE EXTREME CAUTION WHEN HANDLING THE BLADES. THEY ARE EXTREMELY SHARP. ALWAYS REMOVE CHOPPING BLADE COVERS BEFORE USING.**

The double chopping blade may be used with one blade or with two blades.

1. To use as a double blade, carefully slip the separate blade over the shaft of the main blade. (Fig. 2 & Fig. 3)

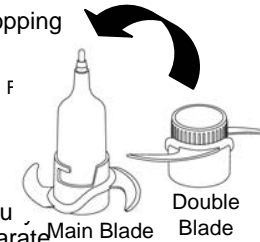
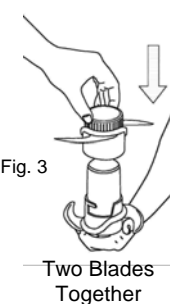

Fig. 3



2. Then insert onto the shaft of the processor bowl. Always hold the chopping blade by the upper plastic part. (Fig. 4)

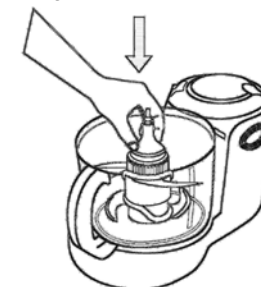

Fig. 4

## OPERATING INSTRUCTIONS

### Using The Double Chopping Blade (Cont.)

- Place ingredients to be processed in the bowl.
- Then holding the processor lid by the feeding tube, place the processor lid onto the bowl and turn counter clockwise to lock the lid in place. Ensure that the lid tab has "clicked" into place and that the arrow on the lid is aligned with the dot on the unit. (Fig. 5 & Fig. 6)

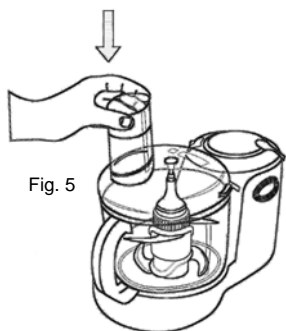

Fig. 5



Fig. 6

- Plug the processor into a wall outlet.
- Turn the speed control dial to the desired speed setting.

- Keep hands and utensils away from the cutting blade while chopping food., to reduce the risk of severe injury to persons or damage to the food processor. A scraper may be used, but **ONLY** when the food processor is **NOT** running and has been unplugged. **Never** feed food by hand. Always use the food pusher. (Fig. 7)

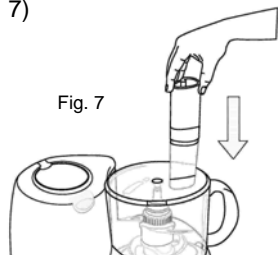

Fig. 7

- When finished processing the ingredients, remove the processor lid by turning clockwise.
- Remove the chopping blade first before removing the processed food.

**FOR SAFETY, ALWAYS USE THE FOOD PUSHER WHEN PUTTING FOOD INTO THE THE FEEDER TUBE. NEVER FEED BY HAND.**

- Do **NOT** leave the appliance unsupervised when it is in the "ON" position.

### PROCESSING EXAMPLES WITH THE DOUBLE CHOPPING BLADE

The processing times indicated below are approximate and also depend on the quantity of the food to be processed and the degree of fineness you require.

PRODUCT	QUANTITY	RECOMMENDED SPEED	OPERATION TIMES
Meat*	24.5 oz / 700 gr.	High/Turbo	15 - 30 seconds
Onions	24.5 oz / 700 gr.	Low	15 - 30 seconds
Nuts	21 oz / 600 gr.	High	15 - 30 seconds
Fish*	24.5 oz / 700 gr.	Pulse	15 - 30 seconds
Cheese	24.5 oz / 700 gr.	Pulse	15 - 30 seconds
Liquids (soups)	24.5 oz / 700 gr.	Pulse	20 seconds
Carrots	24.5 oz / 700 gr.	pulse	40-50 seconds
Bread	4 slices	Low	40 - 50 seconds
Apples	24.5 oz / 700 gr.	High	10 - 30 seconds
Parsley	Max 4 bunches	High/Turbo	10 seconds
Mayonnaise	Max 4 cups/1 liter	High	30 seconds

\* Always allow food to cool before placing in the bowl.  
\* Remove all bones before processing.

## OPERATING INSTRUCTIONS

### Dough Blade

**CAUTION: Make sure that the unit is unplugged from the power source and the operating button is "OFF" before inserting or removing attachments.**

- Make sure that the blade storage cover is closed during use.
- Fit the processor bowl and spindle as described previously on page 4.
- Fit the dough blade over the spindle and press firmly into place. (Fig. 8)
- Place the ingredients into the bowl.
- Fit the lid and click into place as described in the "Setting Up" section (page 4).
- Plug in the food processor.
- Turn the food processor on selecting high speed. Maximum capacity for processing dough is based on the mixture of 21 oz. (600 g.) of flour and 14 oz. (400 g.) of water in order to obtain 2.2 Lbs. (1 kg.) of dough.
- Recommended speed for making dough is high.
- When it is time to knead the dough, place speed control dial in the "Off" position and pulse until the dough it is ready.

10. Remove the blade from the bowl before removing the dough.  
WHEN KNEADING DOUGH, DO NOT OPERATE THE MACHINE LONGER THAN 20 SECONDS. AFTERWARDS WAIT AT LEAST 2 MINUTES BEFORE OPERATING THE MACHINE AGAIN.  
**FOR SAFETY, ALWAYS LEAVE THE PUSHER IN PLACE WHILE OPERATING THE PROCESSOR.**

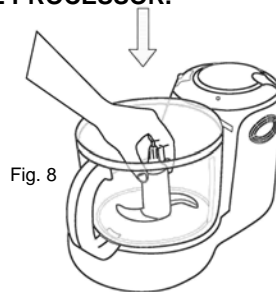

Fig. 8

### Slicing, Shredding & Grating Blades

**CAUTION: Make sure that the unit is unplugged from the power source and the operating button is "OFF" before inserting or removing attachments.**

- Make sure that the blade storage cover is closed during use.
- Place the blade of your choice on the blade holder. Inserting the longer tab on the side of the blade first. (fig. 9)
- Press the other end of the blade until it clicks into place. (fig. 10)
- Fit the processor bowl and spindle as detailed on the page 4.
- Using the finger holes in the blade holder, fit it over the spindle and press firmly into place as indicated. (fig. 11)

**WARNING: USE EXTREME CAUTION WHEN HANDLING BLADES. BLADES ARE SHARP.**

- Fit the lid and click into place as described in the Setting Up section (page 4).
- Plug in the processor.
- WARNING: USE THE FOOD PUSHER TO ADD FOOD INTO THE PROCESSOR BOWL THROUGH THE FEEDER TUBE.**

Do not overload the food processor bowl. In one operation, you can process a maximum of 6 cups (1500 ml) of food.

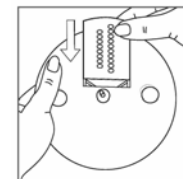

Fig. 9

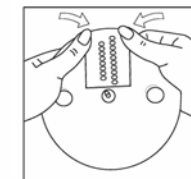

Fig. 10



Fig. 11

## OPERATING INSTRUCTIONS

### French Fry Blade Assembly

**CAUTION: Make sure that the unit is unplugged from the power source and the operating button is "OFF" before inserting or removing attachments.**

**Note: The French Fry Blade is already assembled to the blade holder. Do not try to remove it.** (fig. 12)

1. Make sure that the blade storage cover is closed during use.
2. Fit the processor bowl and spindle as detailed previously.
3. Using the finger holes in the french fry blade holder, fit it over the spindle and press firmly into place as indicated. (fig. 13)

**WARNING: USE EXTREME CAUTION WHEN HANDLING BLADES. BLADES ARE SHARP.**

4. Fit the lid and click into place as indicated in Setting Up section (page 4).
5. Plug in the processor.
6. **WARNING: USE THE FOOD PUSHER TO ADD FOOD INTO THE PROCESSOR BOWL THROUGH THE FEEDER TUBE.**  
Do not overload the bowl. In one operation, you can process a maximum 6 cups (1500 ml) of food.

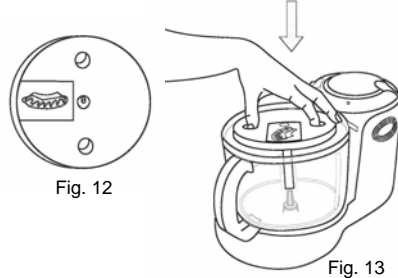

### Processing Examples

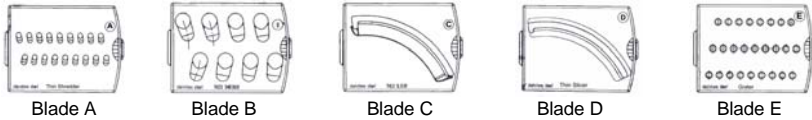

- |                       |   |
|-----------------------|---|
| For fine slicing:     | Blade A - Recommended speed level is High (Cucumbers, raw potatoes, lettuce, carrots) |
| For coarse slicing:   | Blade B - Recommended speed level is High (Cabbage, carrots, onions)                  |
| For fine shredding:   | Blade C - Recommended speed level is High (Carrots, cucumbers, cabbage)               |
| For coarse shredding: | Blade D - Recommended speed level is High (Lettuce, carrots, apples)                  |
| For Grating:          | Blade E - Recommended speed level is High   |

## OPERATING INSTRUCTIONS

### Operating the Blender

Setting up:

1. **CAUTION:** Make sure that the unit is unplugged from the power source and the Speed Control Dial is in the "Off" position before inserting or removing any attachments and before cleaning.
2. Place the food processor bowl onto the processor body. (fig. 14)
3. When fitted correctly, the handle will fit into the slot at the base of the unit.
4. Place the food processor lid on the bowl and lock in place by turning counter clockwise. (fig. 15) Make sure that **NO ATTACHMENTS** are inside the food processor bowl when you are using the blender.
5. Open the safety cover by pressing on the safety cover release button. (fig. 16)
6. Place the blender jar in the opening and turn counter clockwise to lock in place. (fig. 17)
7. **WARNING: Never** operate the blender without the blender lid in place. When processing hot ingredients, remove the measuring cap from the blender lid to allow steam to escape. (Fig. 18)
8. Recommended speed level for blending is "2" (high). When blending soft vegetables or fruits start with level "1" (low) and then go to level "2" (high). For hard vegetables or fruit always use speed level "2" (high).

**IMPORTANT:** Do **NOT** load the blender with more than 10 oz. (300 gr.) of hard vegetables at one time. Do **NOT** operate continuously for more than 20 seconds at one time.

**NOTE:** You can crush 16 oz. (500 ml) of ice cubes in the blender using the **PULSE/TURBO** button.

**CAUTION:** To prevent spilling (overflow) do **NOT** operate the blender with than 4 cups (1000 ml) of soft liquid (i.e. soup) at one time.

- \* Always operate the blender with the blender lid in place.
- \* When blending hot liquids, always remove the small measuring cap in the blender lid.
- \* Avoid contact with moving parts at all times.
- \* Keep hair, clothing as well as spatulas and other kitchen utensils out of the blender jar while in operation to reduce the risk of severe injury to persons or damage to the blender. A spatula may be used but **ONLY** when the unit is not in use.

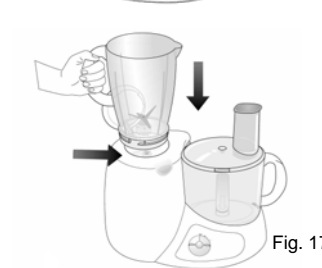
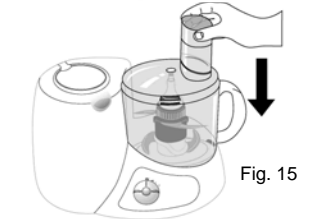
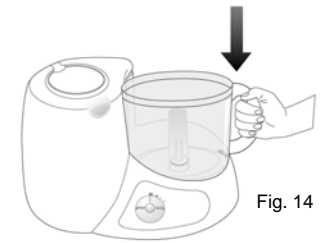

## CLEANING & MAINTENANCE

**CAUTION:** Make sure that the unit is unplugged from power source and control button is on "OFF" before inserting or removing any attachments and before cleaning.

- Never immerse the unit, cord or plug in water or any other liquid.
- Clean the main unit with a damp cloth only.
- Only the stainless steel blades can be washed in the dishwasher.
- All other parts can be cleaned in warm sudsy water using regular dishwashing liquid.
- If food has spilled over on to the main unit, use the pointy end of the spatula to clean the cracks and crevices of the base under the food processor bowl. (Fig. 19)
- To clean the blender, fill the blender jar with warm, sudsy water, place the blender lid on the unit and run the blender at speed level "2" (high) for 30 seconds. Rinse and repeat if necessary.



Fig. 19

### Hints & Tips:

- The double chopping blade can be used for chopping meat, fish, vegetables, cheese, etc. setting the speed to maximum.
- For finer chopping, increase the length of time you process.
- For coarser chopping, use the pulse button for a few seconds and monitor food texture.
- Pre-cut larger pieces to make them fit into the feed tube. When chopping hard foods (e.g. meat, cheese) cut into 1 "2.4 cm cubes.
- For shredding, place food horizontally into the feed tube, for slicing place the food vertically.
- When blending, pour the liquids in first and then add the solid food. Begin blending at the lower speed and increase when needed.

### Storing the Blades

Your Processing Center comes with a blade storage compartment and a cover to store your blades when they are not in use. (Fig. 20)

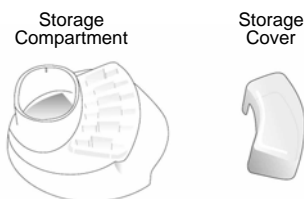

Fig. 20

Place the blade storage compartment over the food processor lid. (fig. 21)

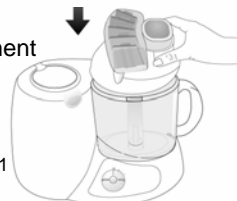

Fig. 21

Carefully insert the blades into the slots. (fig. 22)



Fig. 22

Place the blade storage cover over the blades. (fig. 23)

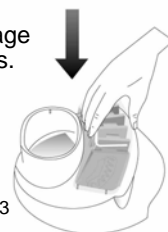

Fig. 23

You can also store the blender with the unit as shown in fig. 24.



Fig. 24

## CLEANING & MAINTENANCE

**CAUTION:** Make sure that the unit is unplugged from power source and control button is on "OFF" before inserting or removing any attachments and before cleaning.

### Re-settable Thermal Safety Device

Your Processing Center has been designed with a unique safety system which prevents damage to the unit's motor and drive system, should you inadvertently overload your appliance. The safety system will automatically cut the electric power to the appliance when the device senses an overload or excessive temperature in the motor or drive system. Should this occur during use and the appliance stops functioning, following is the re-setting procedure:

1. Turn the "ON/OFF" speed control to the "OFF" position
2. Unplug the unit from the wall receptacle.
3. Remove and empty the processor bowl. Ensure that no food is jamming the cutting blades or attachments.
4. Allow the appliance to cool down for a minimum of 30 minutes.
5. Re-install the processor bowl and re-plug appliance in the wall outlet.
6. Proceed to use the appliance as before. Should the appliance still fail to operate, turn the "ON/OFF" speed control to the "OFF" position and unplug from the wall outlet. Allow the appliance to cool down for an additional 1 to 2 hours. After this time has passed, repeat the restart procedure, steps 5 and 6 above.



# ONE (1) YEAR LIMITED WARRANTY

**EURO-PRO OPERATING LLC** warrants this product to be free from defects in material and workmanship for a period of one (1) year from the date of purchase when utilized for normal household use.

If your appliance fails to operate properly while in use under normal household conditions within the warranty period, return the complete appliance and accessories, freight prepaid. For Customer Service support, call 1 (800) 798-7398 or visit our website [www.euro-pro.com](http://www.euro-pro.com). If the appliance is found to be defective in material or workmanship, **EURO-PRO Operating LLC** will repair or replace it free of charge. Proof of purchase date and \$14.95 to cover the cost of return shipping and handling must be included.\*

The liability of **EURO-PRO Operating LLC** is limited solely to the cost of the repair or replacement of the unit at our option. This warranty does not cover normal wear of parts and does not apply to any unit that has been tampered with or used for commercial purposes. This limited warranty does not cover damage caused by misuse, abuse, negligent handling or damage due to faulty packaging or mishandling in transit.

This warranty is extended to the original purchaser of the unit and excludes all other legal and/or conventional warranties. The responsibility of **EURO-PRO Operating LLC** if any, is limited to the specific obligations expressly assumed by it under the terms of the limited warranty. **In no event is EURO-PRO Operating LLC** liable for incidental or consequential damages of any nature whatsoever. Some states do not permit the exclusion or limitation of incidental or consequential damages, so the above may not apply to you.

This warranty gives you specific legal rights, and you may also have other rights which vary from state to state.

**\*Important: Carefully pack item to avoid damage in shipping. Be sure to include proof of purchase date and to attach tag to item before packing with your name, complete address and phone number with a note giving purchase information, model number and what you believe is the problem with item. We recommend you insure the package (as damage in shipping is not covered by your warranty). Mark the outside of your package "ATTENTION CUSTOMER SERVICE". We are constantly striving to improve our products, therefore the specifications contained herein are subject to change without notice.**



## OWNERSHIP REGISTRATION CARD FOR CANADIAN CONSUMERS ONLY

Please fill out and mail the product registration card within ten (10) days of purchase. The registration will enable us to contact you in the unlikely event of a product safety notification. By returning this card you acknowledge to have read and understood the instructions for use, and warnings set forth in the accompanying instructions.

RETURN TO **EURO-PRO OPERATING LLC**, 4400 Bois Franc, St-Laurent, QC, H4S 1A7

**KP81E**

Appliance model \_\_\_\_\_

Date purchased \_\_\_\_\_ Name of store \_\_\_\_\_

Owner's name \_\_\_\_\_

Address \_\_\_\_\_ City \_\_\_\_\_ Prov. \_\_\_\_\_ Postal Code \_\_\_\_\_

## Free Manuals Download Website

<http://myh66.com>

<http://usermanuals.us>

<http://www.somanuals.com>

<http://www.4manuals.cc>

<http://www.manual-lib.com>

<http://www.404manual.com>

<http://www.luxmanual.com>

<http://aubethermostatmanual.com>

Golf course search by state

<http://golfingnear.com>

Email search by domain

<http://emailbydomain.com>

Auto manuals search

<http://auto.somanuals.com>

TV manuals search

<http://tv.somanuals.com>