

OWNER'S MANUAL

# **Shark**<sup>™</sup> **StingRay**

Steam Iron  
Model EP470



For information or assistance:

**USA:** **EURO-PRO** Corporation  
178 West Service Rd.  
Champlain, NY 12919  
Tel.: 800-798-7398

**Canada:** **EURO-PRO** Corporation  
4400 Bois Franc  
St. Laurent, QC H4S 1A7  
Tel.: 514-842-8691

[www.sharkhomecare.com](http://www.sharkhomecare.com)

**EURO-PRO** 

**LIMITED WARRANTY**

**EURO-PRO** Corporation warrants this product to be free from defects in material and workmanship for a period of one (1) year from the date of purchase. The liability of **EURO-PRO** Corporation is limited solely to the repair or replacement of the product at **EURO-PRO**'s option. This warranty does not cover damage caused by misuse, negligence, use on improper current or voltage, use contrary to operating instructions or disassembly, repair or alteration by any person other than an authorized **EURO-PRO** service station.

Product repair or replacement, at our option, is your sole remedy. This warranty excludes all other legal and/or conventional warranties. The responsibility of **EURO-PRO** Corporation, if any, is limited to the specific obligations expressly assumed by it under the terms of the limited warranty. In no event is **EURO-PRO** Corporation liable for incidental or consequential damages of any nature whatsoever. Some States do not permit the exclusion or limitation of incidental or consequential damages, so the above may not apply to you. This warranty gives you specific legal rights which vary from state to state.

If you have a claim under this warranty or if you require service  
**DO NOT RETURN THIS PRODUCT TO THE STORE!**

Send the product, postage prepaid to:

In Canada: **EURO-PRO Corp.**  
4400 Bois Franc  
St. Laurent, Quebec  
H4S 1A7  
Tel: (514) 842-8691

In U.S.A.: **EURO-PRO Corp.**  
178 West Service Rd.  
Champlain, NY 12919  
Tel: (800) 798-7398

**Please include a copy of your sales receipt, \$9.50 to cover the cost of return shipping & handling** and a letter explaining the nature of your difficulty. **Do not forget to enclose your name, address and telephone number.**

**If the warranty period has expired, please send your iron postage pre-paid to:**

In Canada: Service Department  
**EURO-PRO Corp.**  
4400 Bois Franc  
St. Laurent, Quebec  
H4S 1A7  
Tel: (514) 842-8691

In U.S.A.: Service Department  
**EURO-PRO Corp.**  
178 West Service Rd.  
Champlain, NY 12919  
Tel: (800) 798-7398

**You will be advised of the cost of repair before any servicing is done unless you enclose a note indicating that you would like us to proceed with the repairs and return the iron to you C.O.D.**



**PRODUCT REGISTRATION CARD**

Please complete and return within ten (10) days of purchase. The registration will enable us to contact you in the event a product defect is discovered. By returning this card you acknowledge to have read and understood the instructions for use, and warnings set forth in the accompanying instructions.

RETURN TO: **EURO-PRO** Corporation, 178 WEST SERVICE RD., CHAMPLAIN, N.Y. 12919  
IN CANADA: **EURO-PRO** Corporation, 4400 BOIS FRANC, ST. LAURENT, QUE. H4S 1A7

PURCHASER: .....

ADDRESS: .....

DATE OF PURCHASE: ..... MODEL: **Model EP470** SERIAL NO: .....

NAME AND ADDRESS OF STORE: .....

## TROUBLESHOOTING

PROBLEM	POSSIBLE REASONS & SOLUTIONS
Iron does not heat	<ul style="list-style-type: none"> <li>• Iron should be plugged into a 120V AC electrical outlet only. Make sure that the plug is securely in the socket.</li> <li>• Temperature setting too low. Turn to higher setting.</li> </ul>
Thermostat ready light goes On and Off	<ul style="list-style-type: none"> <li>• This is normal. The light goes On and Off as the thermostat is switching the heating element On and Off to maintain the selected temperature.</li> </ul>
Some odor or small particles come out of steam vents of new iron	<ul style="list-style-type: none"> <li>• This is normal. Follow instructions for first use and allow iron to steam through 2-3 fillings &amp; press the steam burst button occasionally to eliminate small white particles.</li> </ul>
Iron does not steam	<ul style="list-style-type: none"> <li>• Water tank may be empty or water level is very low. Add water.</li> <li>• Make sure that the temperature control dial and the variable steam control are correctly set. For maximum steam, (setting 'Max' on steam control), temperature control dial should be set on '***'.</li> <li>• Adjustable steam control is set on "0". Always allow the iron to reach the selected temperature with the adjustable steam control setting at '0'. Make sure the temperature control dial is set in the correct steam area, e.g. '*', and the steam control is <u>not</u> on '0'. For more steam, turn temperature dial to higher setting, e.g. '***', and the steam control to 'Max'.</li> <li>• If temperature setting and steam control setting are correct and there is no steam, <u>gently</u> tap the soleplate on the ironing board a few times. Move the variable steam control from '0' to 'Max' a few times.</li> </ul>
Water droplets coming from steam vents	<ul style="list-style-type: none"> <li>• Iron may not be hot enough. Set thermostat to the 'Max' position. Always allow iron sufficient time to heat up (thermostat light goes off) before activating the variable steam control.</li> <li>• Overuse of steam burst. Allow more time between each burst.</li> <li>• Iron may have been overfilled. Turn iron off, empty water and follow instructions for filling.</li> <li>• Steam performance may be low if iron requires seasoning. To season, use regular tap water for 1 or 2 tanks until steam performance improves.</li> </ul>

## IMPORTANT SAFETY INSTRUCTIONS

When using your iron, basic safety precautions should always be followed, including the following:

1. Read all instructions carefully.
2. Use iron only for its intended use.
3. To protect against risk of electrical shock, do not immerse the iron in water or other liquids. Always turn the iron to "OFF" before plugging in or unplugging from outlet.
4. Never yank cord to disconnect from outlet. Grasp plug and pull to disconnect.
5. Do not allow cord to touch hot surfaces. Let iron cool completely before putting away.
6. Always disconnect iron from electrical outlet when filling with water, emptying, or when not in use.
7. Do not operate iron with a damaged cord, or after the iron has been dropped or damaged in any manner. To avoid the risk of electric shock, do not disassemble the iron. Return the iron to the nearest service facility for examination and repair. Incorrect reassembly can cause the risk of electric shock when the iron is used.
8. Close supervision is necessary for any appliance being used by or near children. Do not leave iron unattended while connected or on an ironing board.
9. Burns can occur from touching hot metal parts, hot water or steam. Use caution when you turn a steam iron upside down; there may be hot water in the reservoir.
10. **This appliance is for household use only.**

### SPECIAL INSTRUCTIONS

1. To avoid a circuit overload, do not operate another high-wattage appliance on the same circuit.
2. If an extension cord is absolutely necessary, use a 13-ampere cord. Cords rated for less amperage may overheat. Use care to arrange the cord so that it cannot be pulled or tripped over.

**POLARIZED PLUG:** This appliance has a polarized plug (one blade is wider than the other). As a safety feature, this plug will fit into a polarized outlet only one way. If the plug does not fit fully into the outlet, reverse the plug. If it still does not fit, contact a qualified electrician. Do not attempt to defeat this safety feature.

## SAVE THESE INSTRUCTIONS

### For Household Use Only

# IRONING CHART

**NOTE:** Before starting to iron delicate fabrics, it is best to first test the temperature of the iron on a hem or an inside seam.

To select iron temperature, align temperature selected on dial with the indicator on the water tank.

DIRECTIONS ON LABEL					
FABRIC		SYNTHETIC FIBERS, e.g. acrylic, nylon polyester	SILK WOOL	COTTON LINEN	Please note that  on the label means 'THIS ARTICLE CANNOT BE IRONED!'
TEMP. CONTROL		MIN ●	● ●	MAX ● ● ●	
STEAM CONTROL		0	MINIMUM STEAM	MAXIMUM STEAM	
BURST OF STEAM					
SPRAY					

## USER MAINTENANCE INSTRUCTIONS (CONT.)

### SELF CLEANING

It is important to "Self Clean" the iron at least every two weeks to remove scale, calcium, etc. The harder the water, the more often the iron should be self cleaned.

1. Set the variable steam control to "No steam position".
2. Fill the water tank up to the "MAX" level.
3. Place the iron in the upright position. Plug the iron into the electrical outlet and set the temperature control dial to the maximum temperature.
4. Wait until the iron heats up and thermostat light goes off and then comes on again.
5. Hold the iron horizontally over the sink and slide the variable steam control to the "Self Clean" zone.  
"  " See Figure 9.
6. Boiling water and steam will now be ejected from the holes in the soleplate. The impurities and scale are washed away with it.
7. Move the iron back and forth as this happens.
8. Slide the variable steam control lever to the "No steam position" position after one minute or when the water tank is empty.
9. Stand the iron in the upright position to cool down before storing.

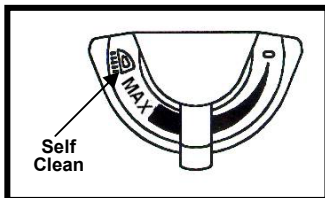

Figure 9

### STORAGE

1. Always turn the variable steam control to "No steam position" after you have emptied the water tank.
2. Allow the iron to cool down.
3. Always store the iron in the upright position to protect the soleplate.
4. From time to time, clean the exterior of the iron with a damp cloth and wipe dry.
5. If you use spray starch, wipe the soleplate occasionally with a soft damp cloth to prevent the build-up of deposits.
6. If the iron has not been used for a few weeks, hold the iron horizontally and allow to steam for 2 minutes before ironing.

## ADDITIONAL IMPORTANT SAFEGUARDS

1. Do not rest iron on soleplate.
2. Never use or rest iron on an unstable surface.
3. While the iron is hot, never set iron on an unprotected surface - even if it is on its heel rest.
4. **WARNING! TO PREVENT ELECTRIC SHOCK OR OTHER INJURY, before filling the iron with water, make sure that the plug is removed from the outlet.**
5. **CAUTION: Never fill the iron with fabric conditioner, starches or any other solution, as these will damage the steam mechanism. Do not use contaminated water.**
6. **WARNING! TO AVOID FIRE, never leave iron unattended while it is plugged in.**
7. **WARNING! TO PREVENT ELECTRIC SHOCK, never immerse the iron in water or other liquid.**
8. **WARNING! TO PREVENT ELECTRIC SHOCK, never use the iron in a location where it can fall or be pulled into water or any other liquid. If the iron falls into water or any other liquid, unplug it immediately. DO NOT reach into the water or liquid.**
9. **CAUTION: Never use scouring pads, abrasive or chemical cleaners, or solvents to clean the exterior or soleplate of your iron. Doing so will scratch and/or damage the surface.**
10. **WARNING! DO NOT aim iron at face, towards yourself, or anyone else while using or adjusting steam. Burns or serious injury may occur.**
11. Always store your iron on the iron rest provided with your iron, not on the soleplate. If stored face down, even the smallest amount of moisture will cause the soleplate to corrode and stain.
12. **DANGER! Never use the iron if it is damaged or dropped. Using the iron when it is damaged could create the risks of fire, electric shock, injury or death.**

## GETTING TO KNOW YOUR IRON

Before using your SHARK Sting Ray Iron, remove any labels, stickers or tags that may be attached to the body or soleplate of the iron.

When turned on for the first time, your new iron may emit an odor for up to 10 minutes. This is due to the initial heating of the materials used in making the iron.

The odor is safe and should not reoccur after initial heating.

Also, before ironing with steam for the first time, allow iron to heat, hold in a horizontal position and hit the burst of steam button several times. The iron may emit some small particles from the steam holes. This is normal and will clear after pressing the burst of steam button several times.

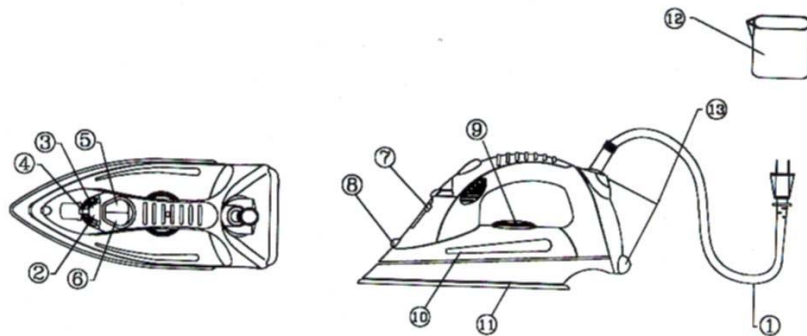

1. Power Supply Cord
2. Auto Shut-Off Light
3. Thermostat Light
4. Variable Steam Control
5. Burst of Steam Button
6. Spray Button
7. Water Filling Inlet Cover

8. Spray Nozzle
9. Temperature Control Dial
10. Water Level Window
11. Stainless Steel Soleplate
12. Water Measuring Beaker
13. Iron Heel Rest

## USER MAINTENANCE INSTRUCTIONS

### EMPTYING THE IRON

1. Always empty iron after each use.
2. When finished using the iron, turn the variable steam control to "No steam position" and the temperature control dial to "MIN".
3. Unplug the iron from the electrical outlet.

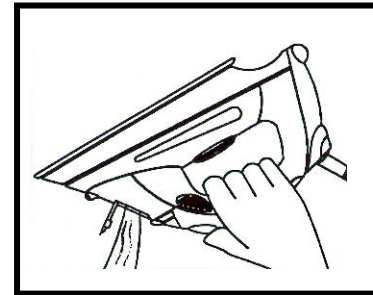

Figure 8

4. Set variable steam control to "MAX".
5. Turn the iron upside down over the sink with the tip pointing downward and allow the water to flow from the opening. (See fig. 8)
6. Set variable steam control to "No steam position".
7. Allow iron to cool in an upright position before storing.

**WARNING!** Use caution when emptying the iron. Burns may occur from touching hot metal surfaces, hot water or steam.

## OPERATING INSTRUCTIONS (CONT.)

### SELECTING IRON TEMPERATURES

Always read garment labels and follow the manufacturer's ironing instructions. Refer to the "Ironing Chart" on page 10 for temperature recommendations:

- Use low settings for synthetics.
- Use moderate settings for wool, silks, and blends.
- Use high settings for cottons and linens.

Temperature Control Dial



Figure 6

Variable Steam Control



Figure 7

**NOTE:** Before starting to iron delicate fabrics, it is best to first test the temperature of the iron on a hem or an inside seam.

### IRONING HINTS

**WARNING!** To prevent fire, do not leave iron unattended while connected.

- Sort articles to be ironed according to the type of fabric. This will reduce the need to adjust the temperature for different types of garments.
- If you are not sure of the fiber content of a garment, test a small area such as a seam or inside hem section before ironing a visible area. Start with a low temperature setting and gradually increase to find the best setting.
- When reducing the temperature to iron sensitive fabrics, allow approximately 2 minutes for the iron to cool to the new temperature setting.
- Fabrics such as velour, wool, linen and silk are best ironed with an ironing cloth to prevent shine marks.

## FEATURES OF EURO-PRO CORDED/CORDLESS IRON

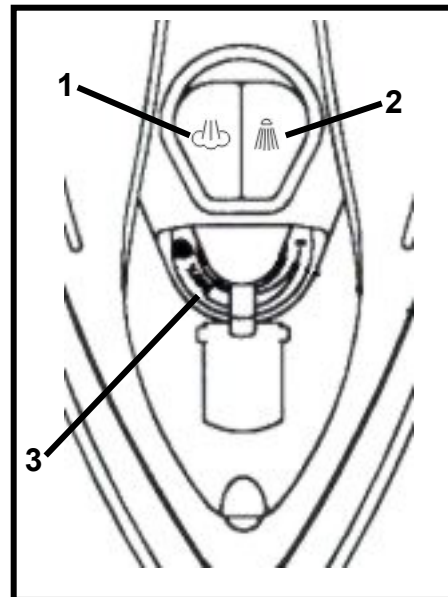

#### 1. BLAST OF STEAM BUTTON

Pressing this Button provides a powerful blast of steam without dripping water.

#### 2. ATOMIZER SPRAY BUTTON

Pressing this Button provides a defined jet of spray which gently moistens fabric.

#### 3. VARIABLE STEAM CONTROL

For selecting dry ironing, slide lever down. For steam ironing, gradually slide lever up to increase the amount of steam.

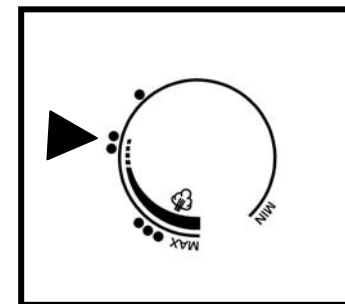

#### 4. TEMPERATURE DIAL

Turn dial to select temperature. Main temperature settings are indicated by the 1, 2 and 3 dots. (See "Ironing Chart.")

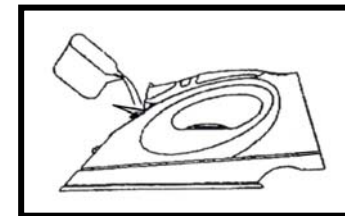

#### 5. WATER FILLING INLET

The cover prevents dust and foreign matter from entering the water tank. It also stops any water from spilling during ironing.

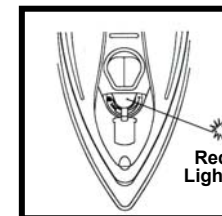

#### 6. AUTO SHUT-OFF

The electronic auto-off switches the iron off if it has been standing unmoved for approximately 8 minutes. A red light will flash when the iron switches itself off. To switch the iron back on again, shake the iron.

## OPERATING INSTRUCTIONS

This appliance is for HOUSEHOLD USE ONLY and may be plugged into any 120V AC polarized electrical outlet. Do not use any other type of outlet.

### DRY IRONING

All marked settings on the temperature dial can be used for dry ironing. Slide the variable steam control lever all the way down as shown in Figure 1. This will cut off the steam flow if water is in the tank.

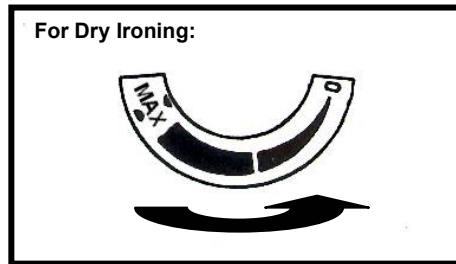

Figure 1

1. Turn temperature dial to "0" and slide the variable steam control lever all the way down.
2. Plug the cord into a polarized, 120V AC electrical outlet. The power "ON" light will come on, indicating that the iron is receiving power.
3. Turn the temperature dial to the desired setting. (See "Ironing Guide" for a guide to temperature selection.)
4. Place iron on its heel (on a stable, protected surface) while iron is warming to desired temperature.

### STEAM IRONING

**WARNING! DO NOT aim iron at face, towards yourself, or anyone else while using or adjusting steam. Burns or serious injury may occur.**

**WARNING! Before filling the iron with water, be sure the iron is not plugged into the electrical outlet. The iron may be filled with water while it is hot.**

**WARNING! TO PREVENT THE RISK OF BURNS, use caution when filling iron with water. Burns can occur from touching hot metal parts, hot water, or steam.**

**NOTE:** Because of the soleplate design, ordinary tap water may be used with this iron. However, in very hard water areas, we recommend using distilled or demineralized water.

**CAUTION: Never fill the iron with fabric conditioner, starches or any other liquid, as these will damage the steam mechanism. Do not use contaminated water.**

1. Turn temperature dial to "MIN" and slide lever all the way to the left.
2. Holding the iron at a slight angle, pour water slowly into the water filling inlet. See figure 2. Fill tank to desired level or to the "MAX" water level marking using the water filling flask. (When the iron is upright, the blue, see-through water tank allows you to gauge the amount of water.) DO NOT overfill the tank.

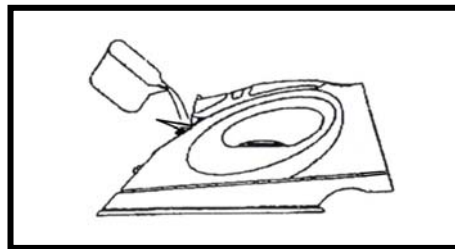

Figure 2

3. Plug the cord into a polarized, 120V AC electrical outlet.

## OPERATING INSTRUCTIONS (CONT.)

4. Turn the temperature dial to any of the temperatures within the gray steam band and allow the iron to heat for approximately 2 minutes before ironing. Place iron on its heel (on a stable, protected surface) while the iron is warming to desired temperature.
5. Slide the steam lever up to increase the amount of steam. When using extra steam, the iron uses more water and it may be necessary to fill the tank more often. See Figure 3.

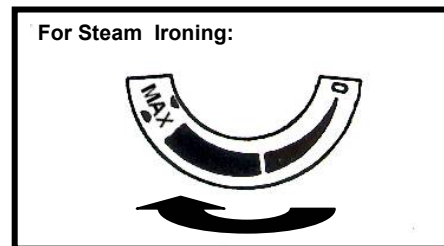

Figure 3

6. Steam is produced as soon as the iron is held in the horizontal position. Steam will stop coming out when the iron is put on its heel in a vertical position or by turning the steam control dial to "0".

### BURST OF STEAM

**WARNING! DO NOT aim iron at face, towards yourself, or anyone else while using or adjusting steam. Burns or serious injury may occur.**

The burst-of-steam button is useful when ironing denim, cotton, and linens. It provides extra, sudden blasts of steam which aid in removing stubborn wrinkles.

The burst-of-steam feature can be used with Dry or Steam ironing as desired.

1. Make sure the water tank is at least 1/2 filled with water.

2. Set the temperature dial. Place the iron on the stand (on a stable, protected surface) and allow it to heat for approximately 2 minutes.
3. With the iron in a horizontal position, press the burst of steam button several times to prime the pump. See Figure 4.

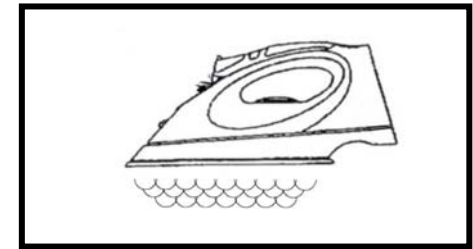

Figure 4

**NOTE:** If the tank runs dry, remove the plug from wall outlet. Then, fill the iron with water and re-prime the pump. The iron may be filled with water while it is hot.

### WATER SPRAY

The water spray is useful on fabrics with stubborn wrinkles. Press the spray button and a jet of water will spray onto the fabric being ironed. See Figure 5.

The water spray can be used with dry or steam ironing as desired.

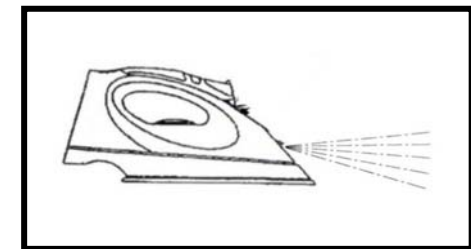

Figure 5



## Free Manuals Download Website

<http://myh66.com>

<http://usermanuals.us>

<http://www.somanuals.com>

<http://www.4manuals.cc>

<http://www.manual-lib.com>

<http://www.404manual.com>

<http://www.luxmanual.com>

<http://aubethermostatmanual.com>

Golf course search by state

<http://golfingnear.com>

Email search by domain

<http://emailbydomain.com>

Auto manuals search

<http://auto.somanuals.com>

TV manuals search

<http://tv.somanuals.com>