



EURO-PRO 
Intelli-Sew™ 400

Model 9136C Instruction Manual

Download from www.Somanuals.com. All Manuals Search And Download.

IMPORTANT SAFETY INSTRUCTIONS

When using an electrical appliance, basic safety should always be followed, including the following:

Read all instructions before using this sewing machine.

DANGER -To reduce the risk of electrical shock:

1. An appliance should never be left unattended when plugged in.
2. Always unplug this appliance from the electrical outlet immediately after using and before cleaning.
3. Always unplug before re-lamping. Replace bulb with same type 5W.

WARNING -To reduce the risk of burns, fire, electrical shock, or injury to persons:

1. Do not allow to be used as a toy. Close attention is necessary when this appliance is used by or near children.
2. Use this appliance only for its intended use as described in this manual. Use only the attachments recommended by the manufacturer as contained in this manual.
3. Never operate this appliance if it has a damaged cord or plug, if it is not working properly, if it has been dropped or damaged, or dropped into water. Return the appliance to the nearest authorized retailer or service center for examination, repair, electrical or mechanical adjustment.
4. Never operate the appliance with any air openings block. Keep ventilation openings of the sewing machine and foot control free from accumulation of lint, dust, and loose cloth.
5. Keep fingers away from all moving parts. Special care is required around the sewing machine needle.
6. Always use the proper needle plate, a wrong needle plate can cause the needle to break.
7. Do not use bent needles.
8. Do not pull or push fabric while stitching. It may deflect the needle causing it to break.
9. Switch the sewing machine off ("O") when making any adjustments in the needle area, such as threading needle, changing needle, threading bobbin, or changing presser foot, and the light.
10. Always unplug sewing machine from the electrical outlet when removing covers, lubricating, or when making any other user servicing adjustments mentioned in the instruction manual.
11. Never drop or insert any object into any opening.
12. Do not use outdoors.
13. Do not operate where aerosol spray products are being used or where oxygen is being administered.
14. To disconnect, turn all controls to the off ("O") position, then remove plug from outlet.
15. Do not unplug by pulling on cord. To unplug, grasp the plug, not the cord.
16. The sound pressure level under normal operating conditions is 75dB(A).
17. Please turn off the machine or unplug when the machine is not operating properly.

SAVE THESE INSTRUCTIONS

This sewing machine is intended for household use only.

Rev. 05/07

CONTENTS

01 INSTRUCTION

PRINCIPAL PARTS OF THE MACHINE	4
ACCESSORIES	5
CONNECTING THE MACHINE TO THE POWER SOURCE	6
Connecting the machine	6
Foot control	6
FUNCTION BUTTONS OF THE MACHINE	7-10
Reverse button	7
Auto-lock button	7
Needle up/ down position button	8
Memory button	8
Clear button	8
Arrow button	8
Stitch length adjustment button	9
Stitch width adjustment button	9
Mirror button	10
MODE selection button	10
Direct pattern selection buttons/ Number buttons	10
LCD SCREEN	11
PATTERN CHART	12

02 GETTING READY TO SEW

WINDING THE BOBBIN	13-14
Bobbin winding	13
INSERTING THE BOBBIN	15
THREADING THE UPPER THREAD	16-17
USING THE NEEDLE THREADER	18
RAISING UP THE LOWER THREAD	19
CUTTING THE THREAD	19
ADJUSTING PRESSER FOOT PRESSURE	20
REPLACING THE NEEDLE	20
MATCHING NEEDLE/ FABRIC/ THREAD	21
THREAD TENSION	22
CHANGING THE PRESSER FOOT	23
TYPE OF PRESSER FOOT CHART	24
TWO-STEP PRESSER FOOT LIFTER	25
TO RAISE OR DROP THE FEED DOGS	25
USEFUL SKILLS	26-27
Reverse	26
Free arm	26
Sewing corners	27
Sewing on the heavy fabric	27
STRAIGHT STITCHES AND NEEDLE POSITION	28
ZIGZAG STITCHES	28
STRETCH STITCH	29

03 UTILITY STITCHES

OVERCASTING STITCHES	30
----------------------------	----

CONTENTS

Using the overcasting foot	30
Using the all purpose foot	30
BLIND HEM.	31
BUTTON SEWING.	32
BUTTONHOLE STITCHING.	33-35
Making a buttonhole on stretch fabrics	35
EYELET STITCH	36
DARNING STITCH	37-38
ZIPPER INSERTION	39-40
Inserting a centered zipper.	39
Inserting a side zipper	40
NARROW HEMMING	41
CORDING	42
Single cording	42
Triple cording	42
SATIN STITCH SEWING	43
QUILTING.	44
SCALLOP STITCH	45
GATHERING	46
SMOCKING	47
FREE MOTION DARNING, EMBROIDERY AND MONOGRAMMING	48-49
Darning	48
Embroidery	49
Monogramming.	49
FAGOTING	50
PATCHWORK STITCHING	50
MIRROR	51
TWIN NEEDLE	52
WALKING FOOT	53
MEMORY	54-56
Combining patterns or letters	54
Adding patterns or letters	55
Clearing patterns or letters.	55
Recalling and sewing the memorized pattern	56

04 APPENDIX

WARNING FUNCTIONS	57
Warning animation message display	57
Instruction animation message display	57
Warning beeping sound.	57
REPLACING THE LIGHT BULB	58
MAINTENANCE	58-59
Cleaning the screen	58
Cleaning the sewing machine surface	58
Cleaning the hook	59
TROUBLE SHOOTING GUIDE.	60-61
QUICK ADJUSTMENT REFERENCE CHART	62-63

PRINCIPAL PARTS OF THE MACHINE

01

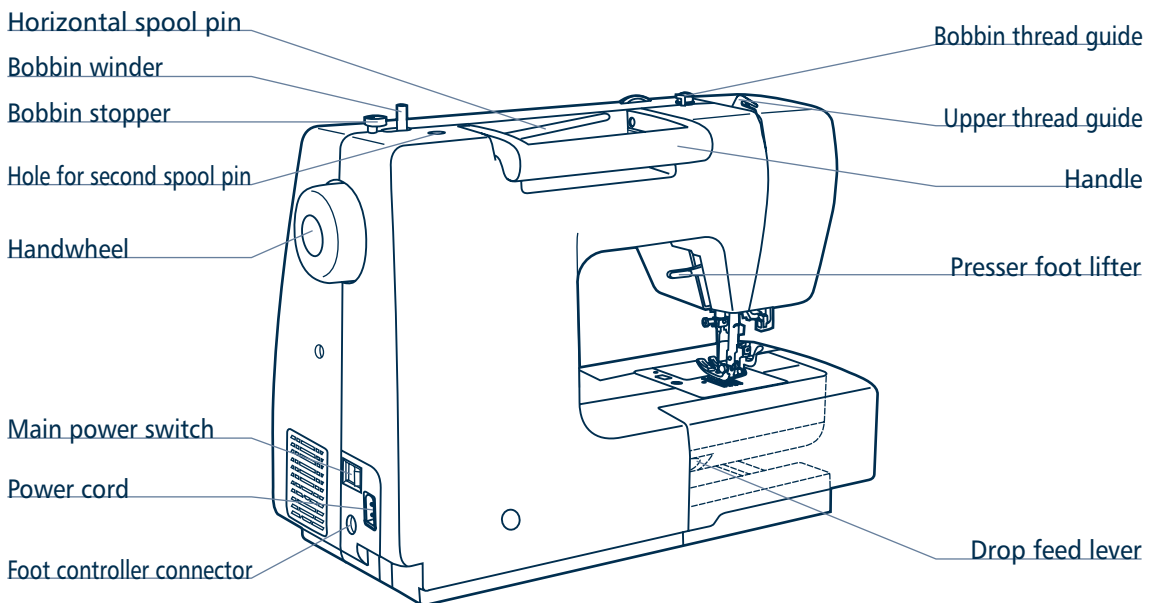
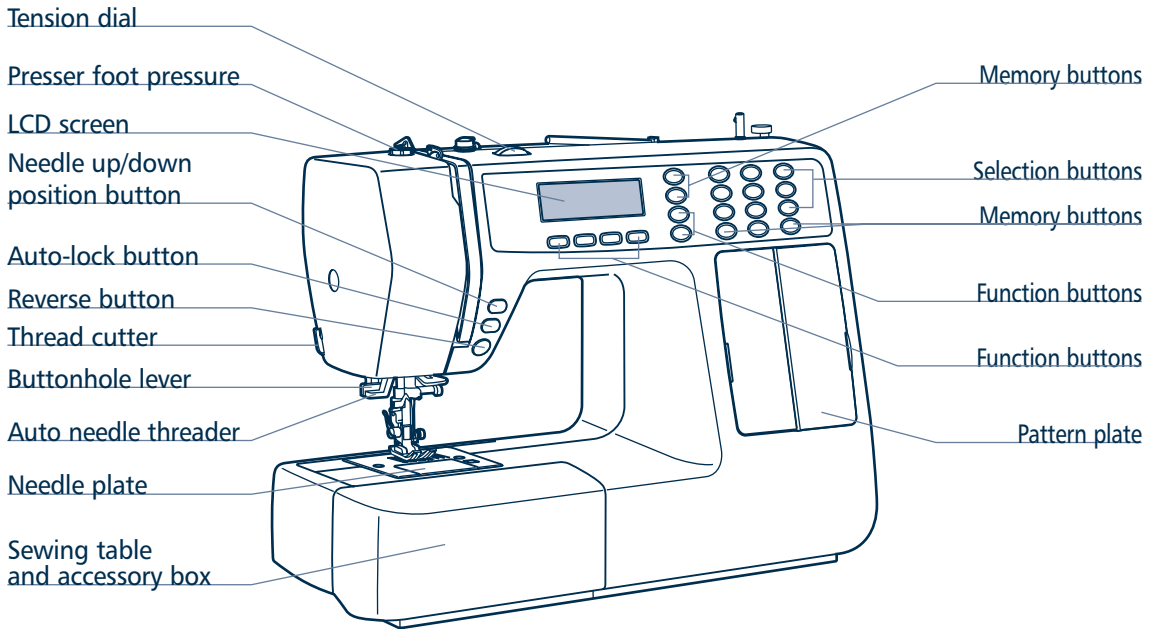

ACCESSORIES

Standard



All purpose foot (T)



Zipper foot (I)



Button sewing foot



Satin stitch foot (A)



Overcasting foot (E)



Blind hem foot (F)

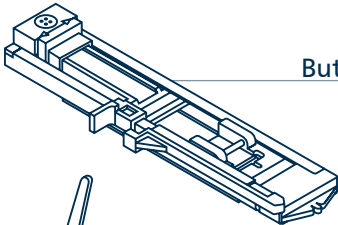

Buttonhole foot (D)



Darning/ Embroidery foot



Cording foot (M)



Hemmer foot (K)



Gathering foot



Quilting foot (P)



Spool holder (Large)



Spool holder (Small)



Spool pin felt



Second spool pin



Pack of needle



Bobbin(3x)



Seam guide



Brush/ Seam ripper

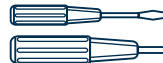

Screwdriver (L & S)

Optional

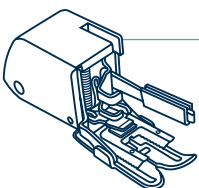

Walking foot



Twin needle

CONNECTING THE MACHINE TO THE POWER SOURCE

01

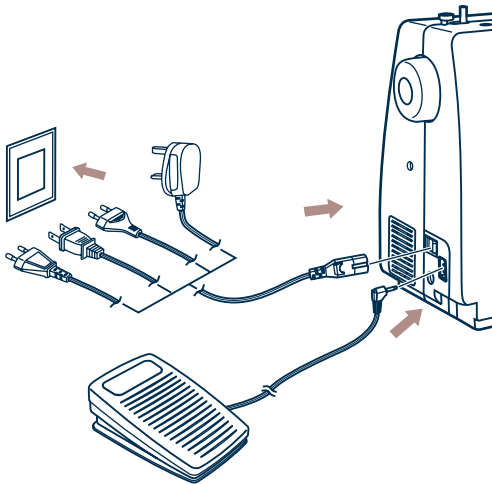

Connecting the machine

Before connecting the power supply, make sure that the voltage and frequency shown on the machine is conforming with your electrical power.

Place the machine on a stable table.

1. Connect the power line plug to the electric outlet.
2. Turn on the power switch.
3. The sewing lamp will light up when the switch is turned on.

⚠ Caution:

Always make sure that the machine is unplugged from power source and the main switch is on "O" when the machine is not in use and before inserting or removing parts.

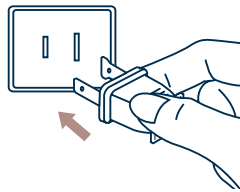

Polarized plug information

This appliance has a polarized plug (one blade wider than the other), to reduce the risk of electrical shock; this plug will fit in a polarized outlet only one way. If the plug does not fit fully in the outlet, reverse the plug. If it still does not fit, contact a qualified electrician. Do not modify the plug in any way.

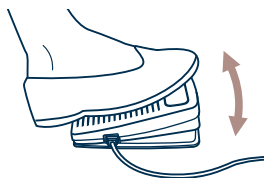

Foot control

With the sewing machine turned off, insert the foot control plug into its connector on the sewing machine. Turn on the sewing machine, and then slowly depress the foot control to start sewing. Release the foot control to stop the sewing machine.

⚠ Attention:

Consult a qualified electrician if in doubt as how to connect the machine to the power source. Unplug the power cord when the machine is not in use.

The appliance must be used with the foot controller C-9000 manufactured by CHIEN HUNG TAIWAN., LTD.

FUNCTION BUTTONS OF THE MACHINE

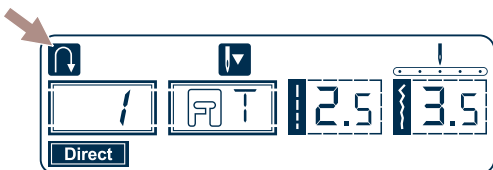
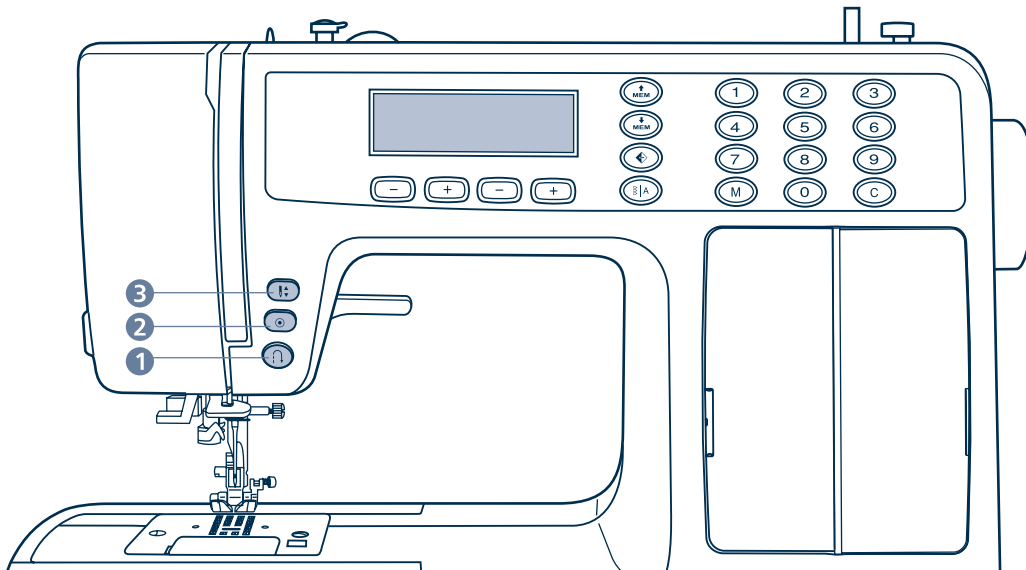

Reverse button (1)

Reverse button is pressed to sew in reverse. An arrow "  " on the LCD display indicates reverse sewing.

Select one pattern (except the Patterns 07-17 and the Direct Patterns "  "), the machine will sew in reverse or a reinforcement stitch at a low speed if the reverse button is pressed. The machine will sew forward after the button is released.



Auto-lock button (2)

When the Direct Patterns 1-4 or the Pattern 00 are selected, the machine will immediately sew 3 locking stitches when the Auto-lock button is pressed, then automatically stop.

The LCD will display the figure "  " until the machine is stopped.



Select one pattern (except the Patterns 00, 07-17 and the Direct Patterns 0-4), press the Auto-lock button, the machine will sew 3 locking stitches at the end of the current pattern and automatically stop.

The LCD will display the figure "  " until the machine is stopped. The function will be cancelled if you press the button once again or select another pattern.

FUNCTION BUTTONS OF THE MACHINE

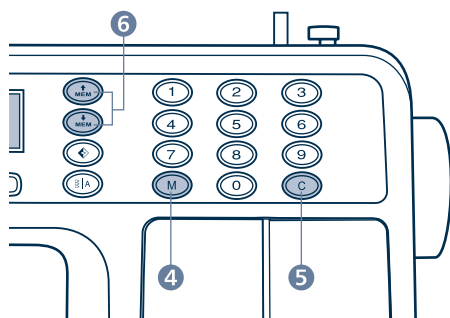
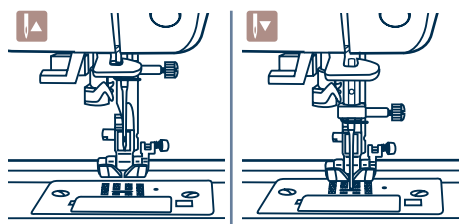
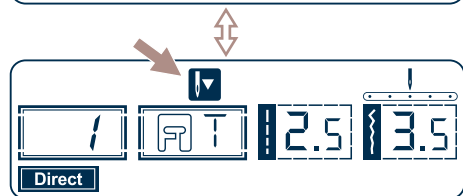
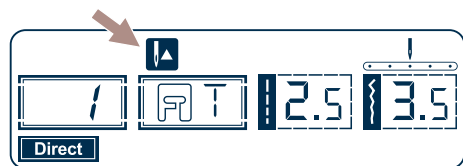

Needle up/ down position button (3) (⏮)

With the Needle up/ down position button, you decide whether the needle shall stop in the up position or in the material when you stop sewing.

➔ Please Note

The needle up/down position button will only work when the machine is not in use.

Press the button so that the arrow, on the LCD screen, will point upward "⏮" and the needle will stop in the highest position.

When you press the button so that the arrow points downward "⏭", the machine will stop with the needle in the lowest position.

Memory button (4) (M)

Press the memory button to enter the memory mode, and store the combinations of characters or decorative stitches.

Press the memory button again to leave the memory mode and return Direct mode.

➔ Please Note

The Direct mode patterns and buttonholes cannot be memorized.

Clear button (5) (C)

Press the clear button when the incorrect character is selected. Each press of this button erases one character, or press this button to remove an added pattern when sewing combinations of characters or decorative stitches.

Arrow button (6) (MEM) (MEM)

Press the arrow button to confirm the pattern memorized by pressing this button in memory mode.

FUNCTION BUTTONS OF THE MACHINE

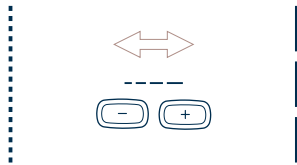
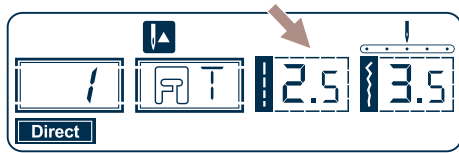

Stitch length adjustment button (7)

When you select a stitch the machine will automatically set the recommended stitch length which will be indicated by numbers on the LCD screen.

The stitch length can be adjusted by pressing the stitch length adjustment buttons. To shorten the stitch length, press the "-" button (left).

To increase the stitch length, press the "+" button (right).

The stitch length can be adjusted between "0.0-4.5". Certain stitches have a limited length.

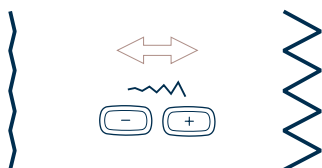

Stitch width adjustment button (8)

When you select a stitch, the machine will automatically set the recommended stitch width, which will be indicated by numbers on the LCD screen.

The stitch width can be regulated by pressing the stitch width adjustment buttons. Certain stitches have a limited stitch width.

For a narrower stitch, press the "-" button (left). For a wider stitch, press the "+" button (right).

The stitch width can be adjusted between "0.0-7.0". Certain stitches have a limited stitch width.



When the Direct Patterns 1-4 and the Pattern 00 are selected,, the needle position is regulated by the stitch width adjustment buttons. Pressing the "-" button (left), will move the needle to the left and pressing the "+" button (right), will move the needle to the right.

The numbers will be changed from left position "0.0" to extreme right position "7.0". The pre-set center needle position will be indicated as "3.5".

FUNCTION BUTTONS OF THE MACHINE

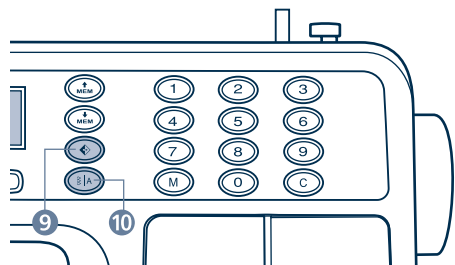

Mirror button (9)

Select one pattern (except the Direct Pattern "!" and the Patterns 07-17), pressing the Mirror button will sew a reflection pattern from your selected stitch.

The LCD will display the mirror function and the machine will continue to sew the reflected pattern until the mirror function is pressed again to cancel the mirror function.

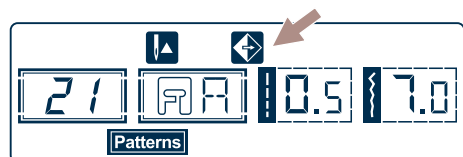

When the mirror function disappears from the LCD screen, the machine will continue to sew the normal stitch. If you change the pattern setting, then the mirror function will be cancelled accordingly. If you need the reflection pattern, then press the mirror button again.

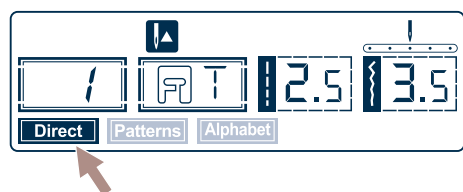



MODE selection button (10)

When you turn the machine "ON" the LCD screen display will be set at the direct mode "Direct".



Press the MODE selection button to select different stitch models.

There are three different stitch models. The LCD lights to the right of the screen, you will be able to see which menu you have selected.

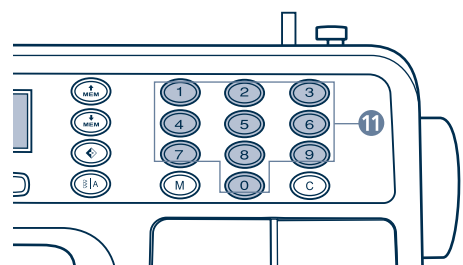
-  Direct mode stitch selection.
-  Utility and decorative pattern mode: Stitch selection using number buttons.
-  Block letter mode: Character selection using number buttons.



Direct pattern selection buttons/ Number buttons (11)

Press the buttons ( ~ ) to select the utility patterns shown beside the number buttons when the mode is set at the Direct mode.

Except the Direct pattern mode, the other mode can be selected by pressing the desired numbers for the pattern needed.

LCD SCREEN

Direct Pattern

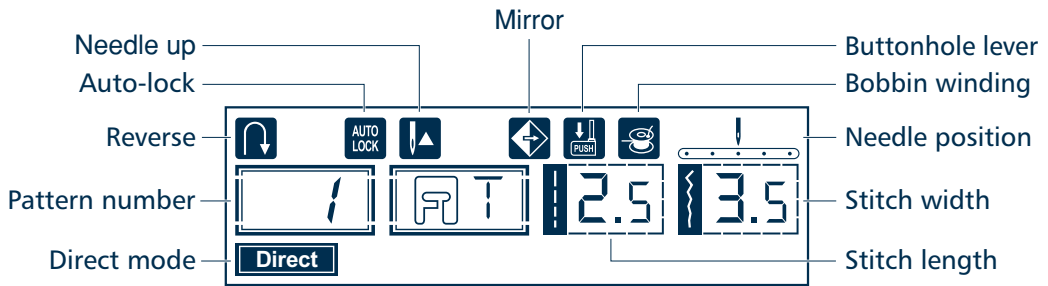

Pattern

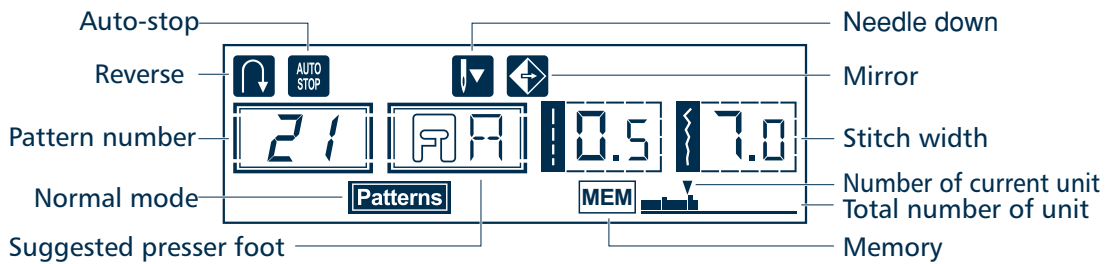

Alphabet

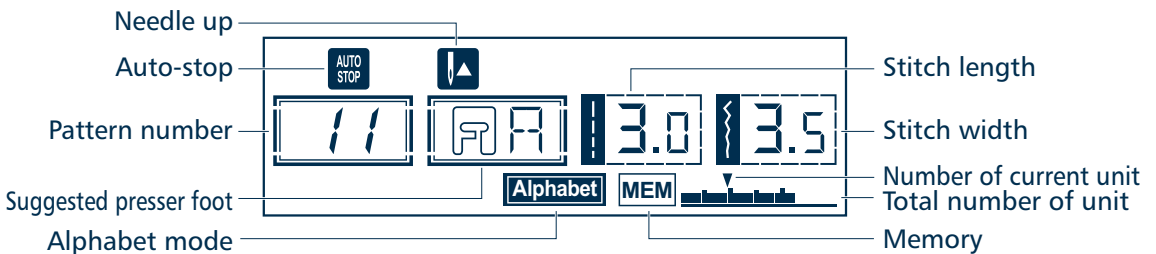

PATTERN CHART

The portion marked in red colored on the chart below shows the one unit of each pattern.

01

Direction Patterns



Patterns

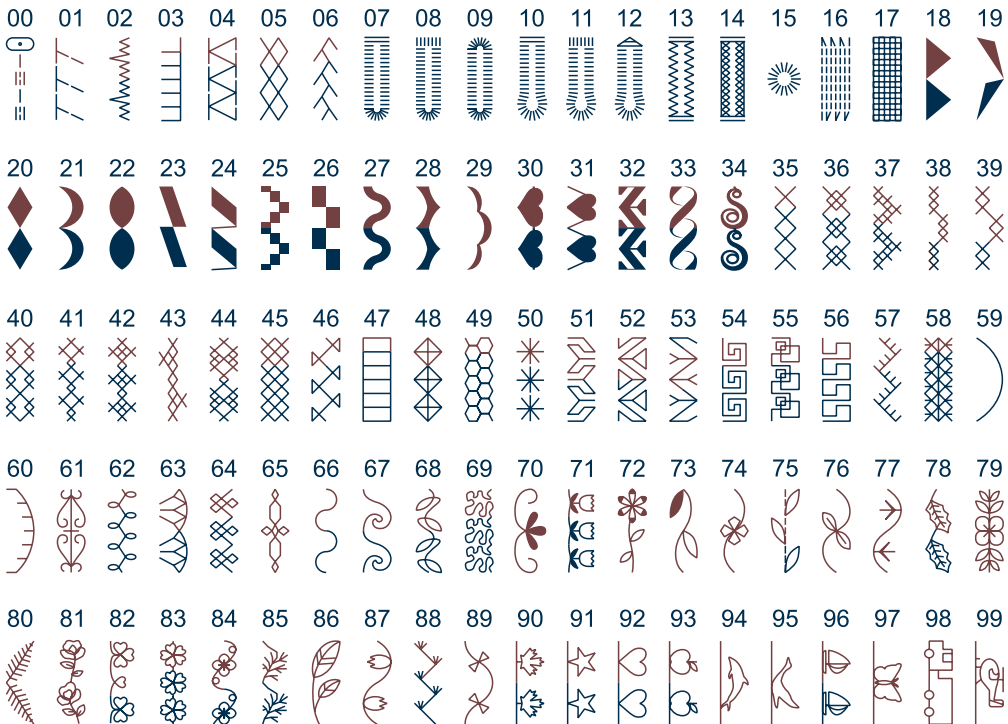

Alphabets



WINDING THE BOBBIN

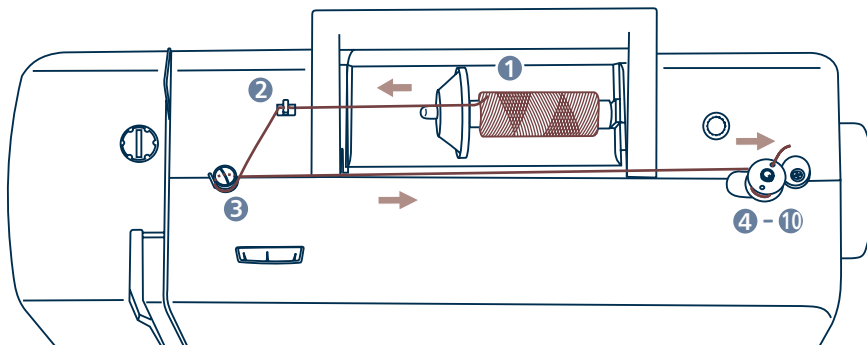

Bobbin winding

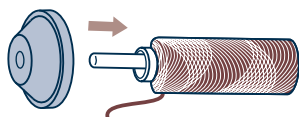

1. Place the thread and spool holder onto the spool pin.

For smaller spools of thread, place spool holder with the small side next to the spool or use the small spool holder.

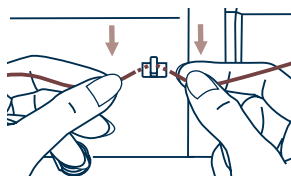

2. Snap the thread into the thread guide.

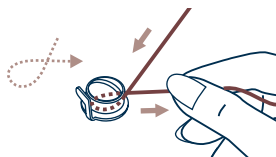

3. Wind the thread clockwise around the bobbin winder tension discs.

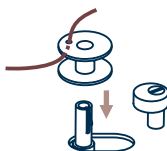

4. Place the thread end through one of the inner holes in the bobbin as illustrated and place empty bobbin on the spindle.

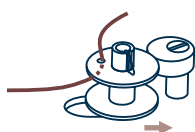

5. Push the bobbin to the right.

WINDING THE BOBBIN

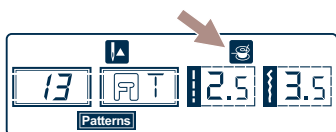

6. When the bobbin winder spindle is push to the right, "bobbin winding position", the symbol "🌀" is shown on the LCD screen.

It will disappear from the LCD screen when the bobbin winder spindle is push to the left, "sewing position".

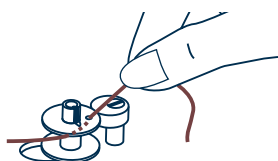

7. Hold the thread tail securely in one hand.

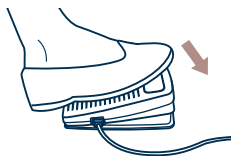

8. Press on the foot control to start the sewing machine.

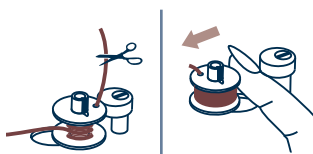

9. After the bobbin has wound a few turns stop the machine and cut the thread near the hole of the bobbin. Continue filling the bobbin until it is full.

The motor stops automatically when the bobbin is full. Stop the machine. Push the bobbin winder spindle to left.

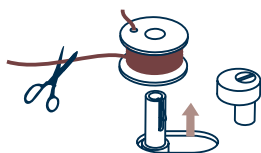

10. Cut the thread and then remove the bobbin.

➡ Please Note:

When the bobbin winder switch is placed on the right, "bobbin winding position", the machine will not sew and the handwheel will not turn. To start sewing, push the bobbin winder switch to the left "sewing position".

INSERTING THE BOBBIN

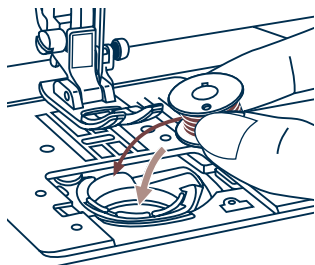

When inserting or removing the bobbin, the needle must be fully raised.

1. Insert the bobbin in the bobbin case with the thread running in a counterclockwise direction (arrow).

⚠ Attention:

Turn power switch to off ("O") before inserting or removing the bobbin.

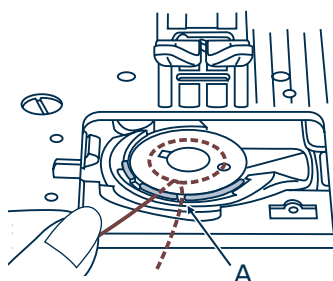

2. Pull the thread through the slit (A).

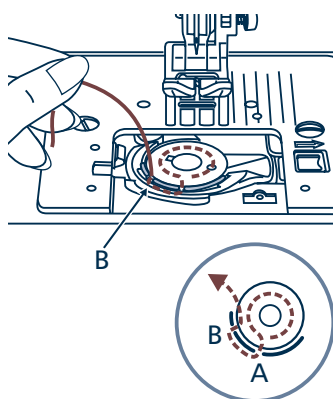

3. Pull the thread toward the left and along the inside of the spring until it slips into the notch (B) being sure that the thread does not slip out of the slit (A).

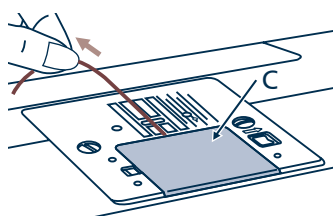

4. Pull out about 15 cm (6 inches) of thread and attach the bobbin cover plate. (C)

THREADING THE UPPER THREAD

02

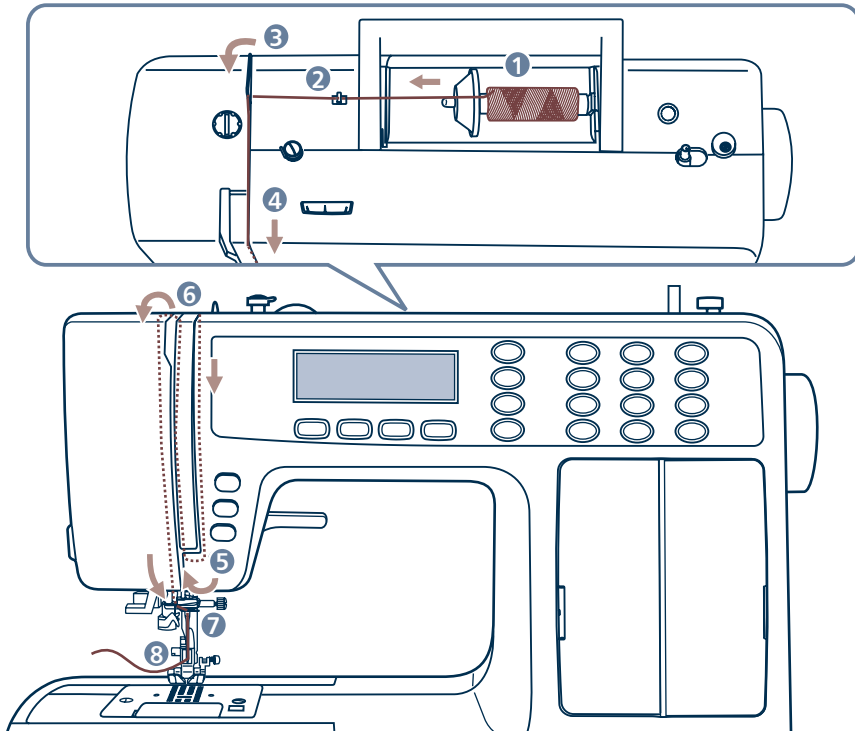

➔ Please Note:

It is important to carry out the threading correctly as by not doing so several sewing problems could result.

Start by raising the needle to its highest point, and also raise the presser foot to release the tension discs.

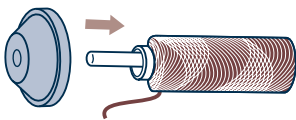

1. Lift up the spool pin. Place the spool of thread on the spool pin so that the thread comes from the front of the spool, then place the spool cap at the end of the spool pin.

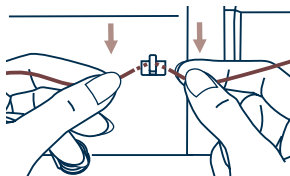

2. Draw the thread from the spool through the upper thread guide.

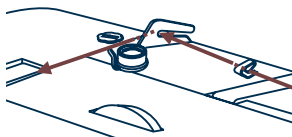

3. Guide the thread around the thread guide pulling the thread through the pre-tension spring as illustrated.

THREADING THE UPPER THREAD

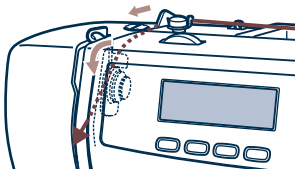

4. Thread the tension module by passing the thread between the silver discs.

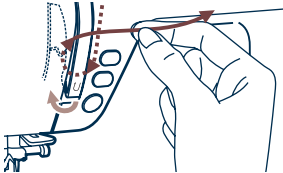

5. Then, down and around the check spring holder.

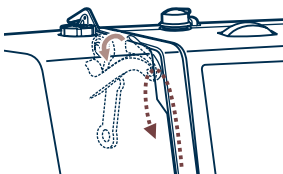

6. At the top of this movement, pass the thread from right to the left through the slotted eye of the take-up lever and then downwards again.

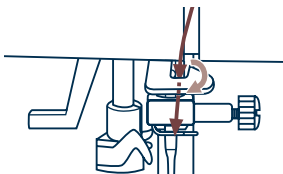

7. Pass the thread behind the flat, horizontal thread guide.

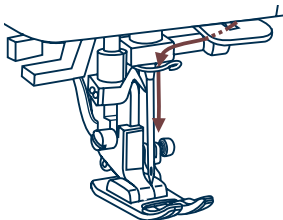

8. Guide the thread through the wire loop.

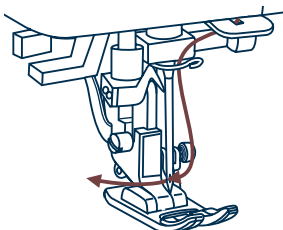

9. Pull the end of the thread through the needle from front to rear, and pull out about 10 cm of thread.

Use the needle threader to thread the needle. (On the next page.)

USING THE NEEDLE THREADER

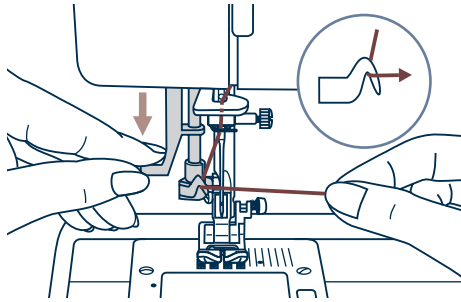

Raise the needle to its highest position and lower the presser foot.

1. Lower the needle threader lever slowly and draw the thread through the thread guide as illustrated and then to the right.

Attention:

Turn power switch to the off position ("O").

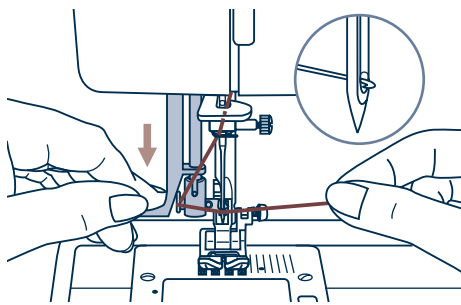

2. The needle threader automatically turns to the threading position and the hook pin passes through the needle eye.

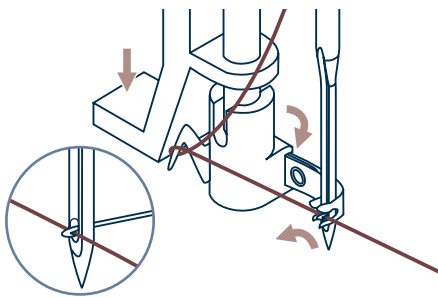

3. Take the thread in front of the needle.

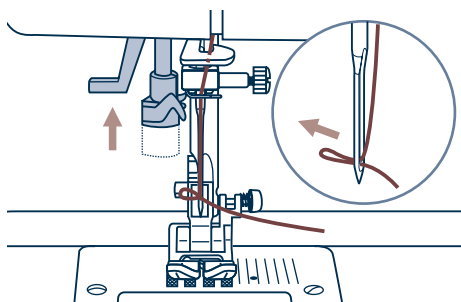

4. Hold the thread loosely and release the lever slowly. The hook will turn and pass the thread through the needle eye forming a loop.

Pull the thread through the needle eye.

RAISING UP THE LOWER THREAD

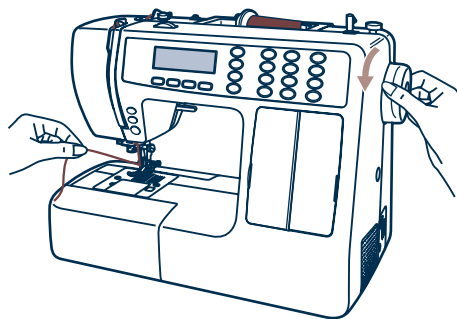

1. Hold the upper thread with the left hand. Turn the handwheel towards you (counterclockwise) lowering, then raising the needle.

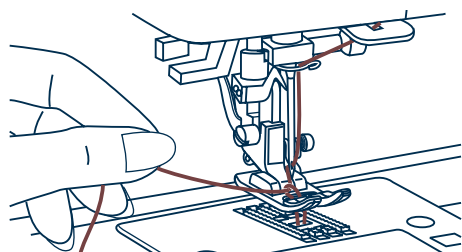

2. Gently pull on the upper thread to bring the bobbin thread up through the needle plate hole. The bobbin thread will come up in a loop.

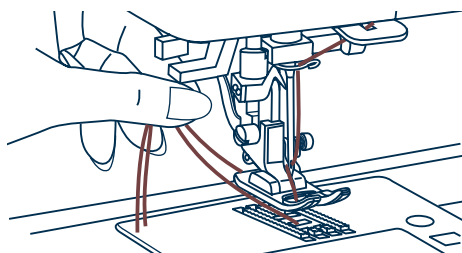

3. Pull both threads to the back under the presser foot.

CUTTING THE THREAD

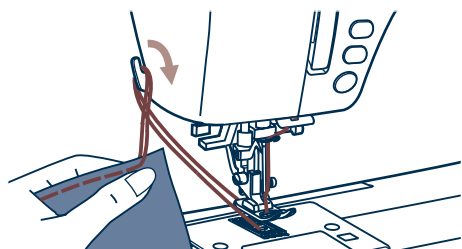

- Raise the presser foot.
Remove the fabric, draw the threads to the left side of the face cover and cut using the thread cutter.
The threads are cut at the proper length to start the next seam.

ADJUSTING PRESSER FOOT PRESSURE

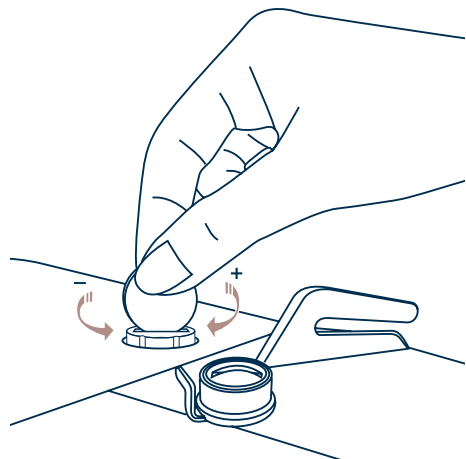

The presser foot pressure of the machine has been pre-set and requires no particular readjustment according to the type of fabric (light-or-heavy weight).

However, if you need to adjust the presser foot pressure, turn the presser adjusting screw with a coin.

For sewing very heavy fabric, tighten the pressure by turning the screw counter clockwise, and for thin fabric, loosen by turning it clockwise.

REPLACING THE NEEDLE

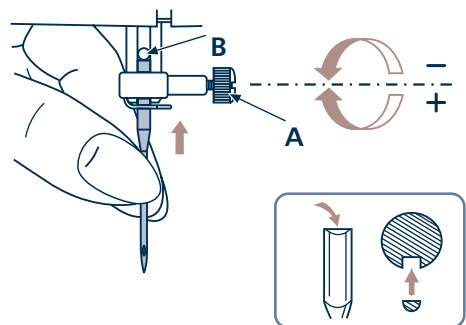

Change the needle regularly, especially if it is showing signs of wear and causing problems.

Insert the needle following the illustrated instructions.

A. Loosen the needle clamp screw and tighten again after inserting the new needle. The flat side of the shaft should be towards the back.

B. Insert the needle as far up as it will go.

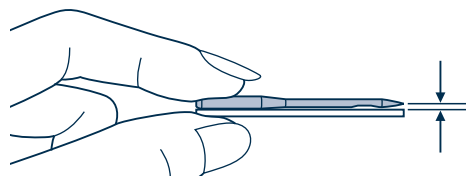

Needles must be in perfect condition.

Problems can occur with:

- Bent needles
- Blunt needles
- Damaged points



Attention:

Turn power switch to off ("O") when carrying out any of the above operations!

MATCHING NEEDLE/ FABRIC/ THREAD

NEEDLE, FABRIC, THREAD SELECTION GUIDE

NEEDLE SIZE	FABRICS	THREAD
9-11 (70-80)	Lightweight fabrics-thin cottons, voile, serge, silk, muslin, Qiana, interlocks, cotton knits, tricot, jerseys, crepes, woven polyester, shirt & blouse fabrics.	Light-duty thread in cotton, nylon, polyester or cotton wrapped polyester.
11-14 (80-90)	Medium weight fabrics-cotton, satin, sailcloth, double knits, light-weight woollens.	Most threads sold are medium size and suitable for these fabrics and needle sizes. Use polyester threads on synthetic materials and cotton on natural woven fabrics for best results. Always use the same thread on top and bottom.
14 (90)	Medium weight fabrics-cotton duck, woolen, heavier knits, terry-cloth, denims.	
16 (100)	Heavyweight fabrics-canvas, woolens, outdoor tent and quilted fabrics, denims, upholstery material (light to medium).	
18 (110)	Heavy woollens, overcoat fabrics, upholstery fabrics, some leathers and vinyls.	Heavy duty thread, carpet thread.

Please Note:

- In general, fine threads and needles are used for sewing fine fabrics, and thicker threads are used for sewing heavy fabrics.
- Always test thread and needle size on a small piece of fabric which will be used for actual sewing.
- Use the same thread for needle and bobbin.

THREAD TENSION

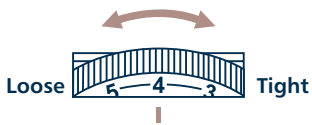

- Basic thread tension setting: "4"
- To increase the tension, turn the dial to the next number up.
To reduce the tension, turn the dial to the next number down.
- Proper setting of tension is important to good sewing.
- There is no single tension setting appropriate for all the stitch functions and fabrics.
- 90% of all sewing will be between "3" and "5" ("4" is basic setting).
- For all decorative sewing you will always obtain a nicer stitch and less fabric puckering when the upper thread appears on the bottom side of your fabric.

02

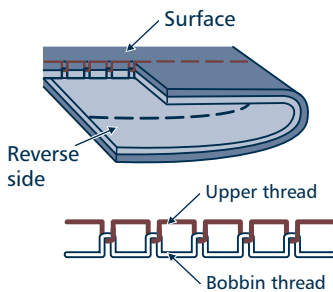

1. Normal thread tension for straight stitch sewing.

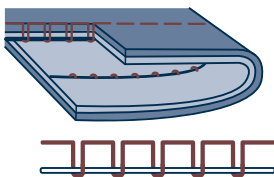

2. Thread tension is too loose for straight stitch sewing. Turn dial to higher number.

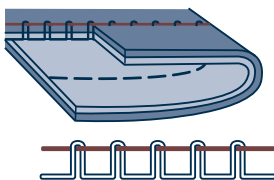

3. Thread tension is too tight for straight stitch sewing. Turn dial to lower number.

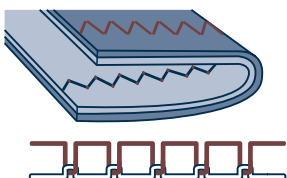

4. Normal thread tension for zig zag and decorative sewing.

CHANGING THE PRESSER FOOT

Attention:

Turn power switch to off ("O") when carrying out any of the above operations!

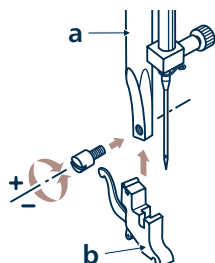

Attaching the presser foot holder (1)

Raise the presser foot bar (a). Attach the presser foot holder (b) as illustrated.

02

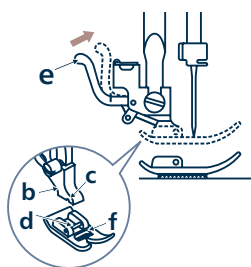

Attaching the presser foot (2)

Lower the presser foot holder (b) until the cut-out (c) is directly above the pin (d).

Raise the lever (e).

Lower the presser foot holder (b) and the presser foot (f) will engage automatically.

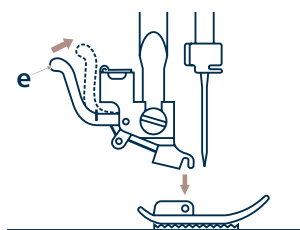

Removing the presser foot (3)

Raise the presser foot.

Raise the lever (e) and the foot will disengage.

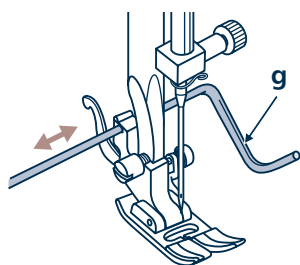

Attaching the seam guide (4)

Attach the seam guide (g) in the slot as illustrated. Adjust according to need for hems, pleats, etc.

23

TYPE OF PRESSER FOOT CHART

PRESSER FOOT	APPLICATION	NEEDLE	PRESSER FOOT	APPLICATION	NEEDLE
<p>All purpose foot (T)</p>	General sewing, Patchwork stitches, Decorative stitching, Smocking, Fagoting, etc.		<p>Cording foot (M)</p>	Cording 	
<p>Zipper foot (I)</p>	Inserting zippers 		<p>Hemmer foot (K)</p>	Narrow hemming 	
<p>Buttonhole foot (D)</p>	Buttonhole sewing 		<p>Darning/ Embroidery foot</p>	Darning Free embroidery Monogramming 	
<p>Button sewing foot</p>	Button sewing 		<p>Quilting foot (P)</p>	Quilting 	
<p>Overcasting foot (E)</p>	Overcasting 		<p>Gathering foot</p>	Gathering 	
<p>Blind hem foot (F)</p>	Blind hem stitching 		<p>Walking foot (Optional)</p>	This foot helps to prevent uneven feeding of very difficult fabrics	
<p>Satin stitch foot (A)</p>	Satin stitch sewing 				

TWO-STEP PRESSER FOOT LIFTER

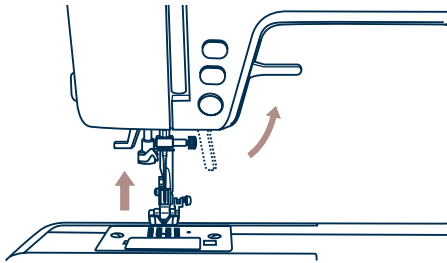

1. The presser foot lifter raises and lowers your presser foot.

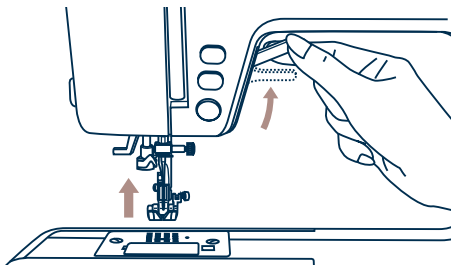

2. When sewing several layers or thick fabrics, the presser foot can be raised a second stage for easy positioning of the work.

02

TO RAISE OR DROP THE FEED DOGS

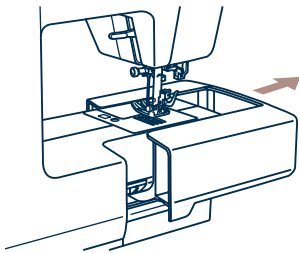

With the sewing table off the machine, the feed dog adjustment lever can be seen on the base in back of the sewing machine.

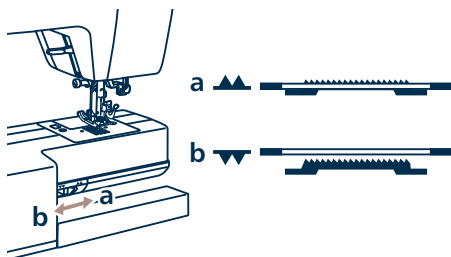

Sliding the lever to the "▼" (b) will lower the feed dog, for example during button sewing. If you wish to continue sewing normally, slide the lever to the "▲" (a) in order to raise the feed dogs.

The feed dog will not rise up if you do not turn the handwheel, even if the lever is slid to the right. Make a complete turn to raise the feed dogs.

25

USEFUL SKILLS

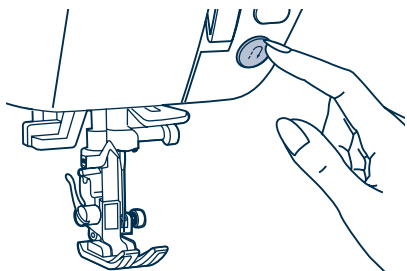

Reverse

Reverse stitching is used to secure the threads at the beginning and at the end of a seam.

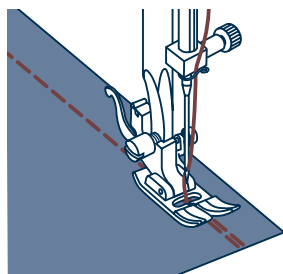

Press the reverse button and sew 4-5 stitches. The machine will sew forward when the button is released.

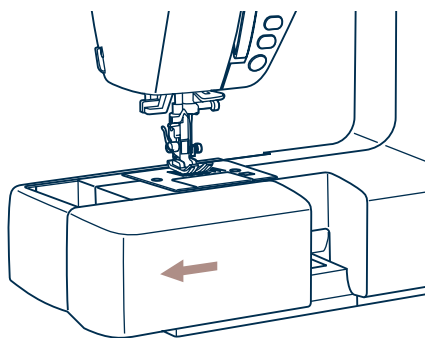

Free arm

Free-arm sewing is convenient for sewing tubular areas such as pant hems and cuffs.

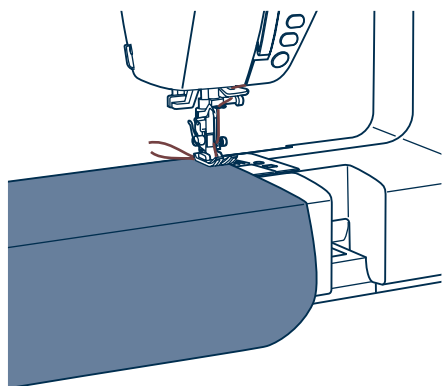

USEFUL SKILLS

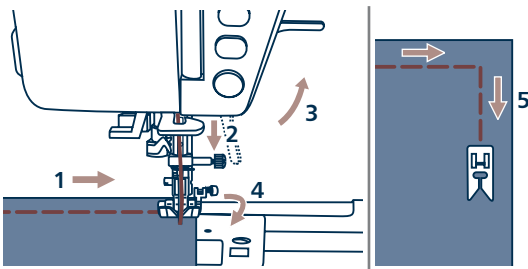

Sewing corners

1. Stop the sewing machine when you reach a corner.
2. Lower the needle into the fabric manually or by pressing the needle up/ down button once.
3. Raise the presser foot.
4. Use the needle as a pivot and turn the fabric.
5. Lower the presser foot and resume sewing.

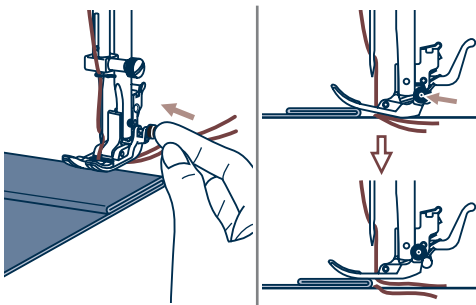

Sewing on the heavy fabric

The black button on the right side of the presser foot will lock the presser foot in a horizontal position if you push it in before lowering the presser foot. This ensures even feeding at the beginning of a seam and helps when sewing multiple layers of fabric such as sewing over seams when hemming jeans.

When you reach the point of an increased thickness, lower the needle and raise the presser foot. Press the toe of the foot and push in the black button, then lower the foot and continue sewing.

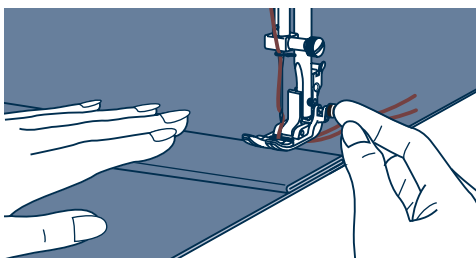

The black button releases automatically after sewing few stitches.

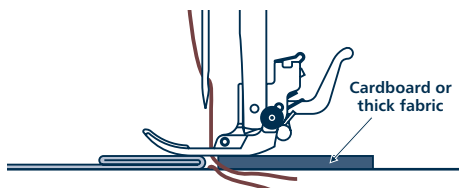

You also can place another piece of fabric with the same thickness at the back of the seam. Or support the presser foot while feeding by hand and sewing toward the folded side.

STRAIGHT STITCHES AND NEEDLE POSITION

02

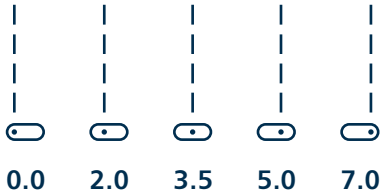
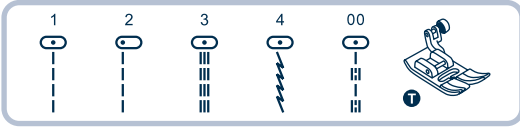

Changing the needle position

These settings apply only to patterns 01-05. The pre-set position is "3.5", center position. When you press the "-" stitch width adjustment button, the needle position will move to the left. When you press the "+" stitch width adjustment button, the needle position will move to the right. On the LCD screen, the point illustration and the number indicate the needle position.

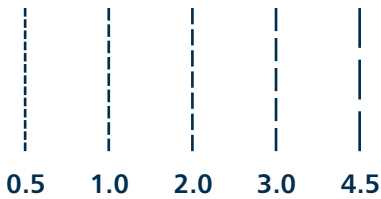

Changing the stitch length

To shorten the stitch length, press the "-" stitch length adjustment button. For a longer stitch length, press the "+" stitch length adjustment button. Generally speaking, the thicker the fabric, thread and needle, the longer the stitch should be.

ZIGZAG STITCHES

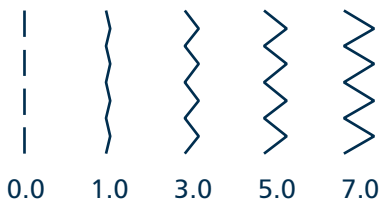
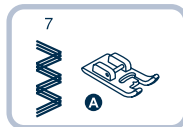
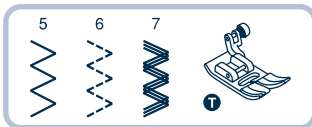

Adjusting the stitch width

The maximum zigzag stitch width for zigzag stitching is "7.0"; however, the width can be reduced on any patterns. The width increases as you press the "+" stitch width adjustment button from "0.0-7.0".

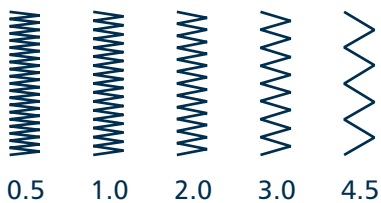

Adjusting the stitch length

The density of zigzag stitches increase as the setting of stitch length approaches "0.2". Neat zigzag stitches are usually achieved at "1.0-2.5". Closed up zigzag stitches (close together) are referred to as a satin stitch.

STRETCH STITCH

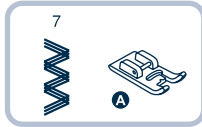
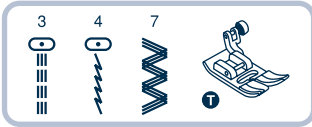

It assures you of a stitch that is strong and flexible and will give with the fabric without breaking.

Good for easy to ravel and knit fabrics. It is good for joining durable fabric such as denims.

These stitches can also be used as a decorative top stitch.

02

Straight stretch stitch

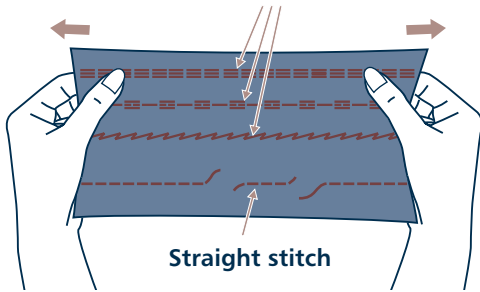

Straight stitch

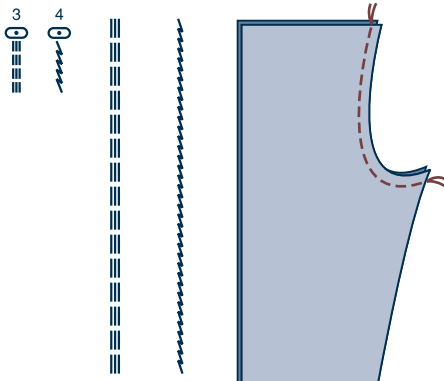

Straight stretch stitch is used to add triple reinforcement to stretch and hardwearing seams.

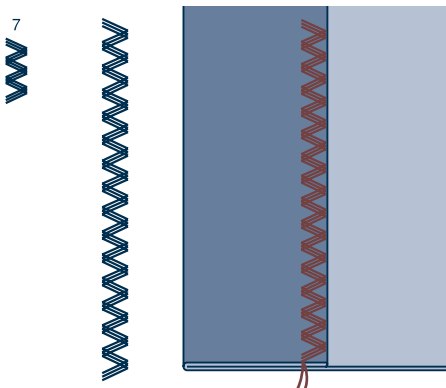

Triple zigzag stretch stitch is suitable for firm fabrics like denim, poplin, duck, etc.

OVERCASTING STITCHES

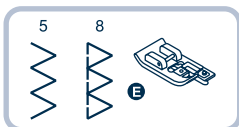

5.0~7.0	2.0~3.0

Using the overcasting foot

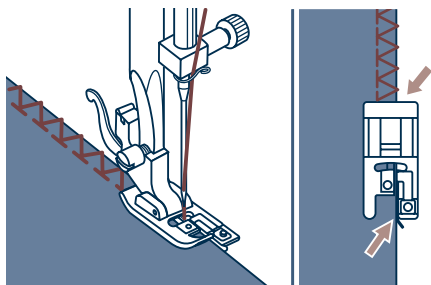

Change the presser foot to the overcasting foot (E).

Sew the fabric with the fabric edge against the guide of the overcasting foot.

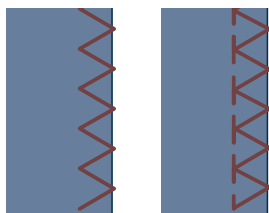

! Attention:

The overcasting foot should be used to sew with patterns 5 and 8 only and do not set the stitch width narrower than "5.0". It is possible that needle could hit the presser foot and break when sewing other patterns and width.

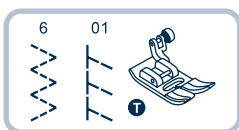

2.5~4.5	2.0~3.0

Using the all purpose foot

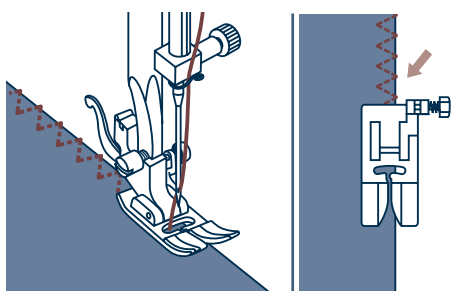

1. Change the presser foot to the all purpose foot (T) .

2. Sewing the overcasting along the edge of the fabric so that the needle drops over the edge of the fabric on the right side.

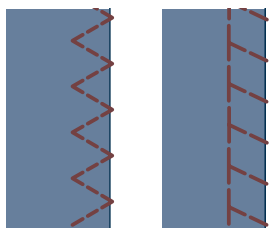

BLIND HEM

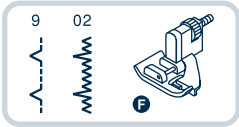

2.5~4.0	1.0~2.0

- 9: Blind hem for firm fabrics
- 02: Blind hem for stretch fabrics

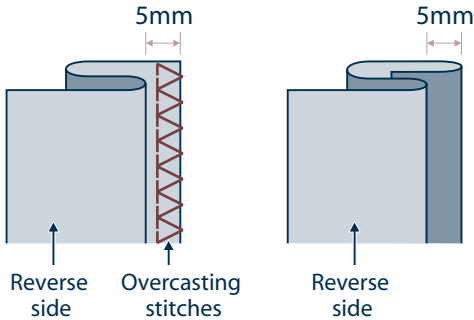

Please Note:
It takes practice to sew blind hems. Always make a sewing test first.

Fold the fabric as illustrated with the wrong side uppermost.

03

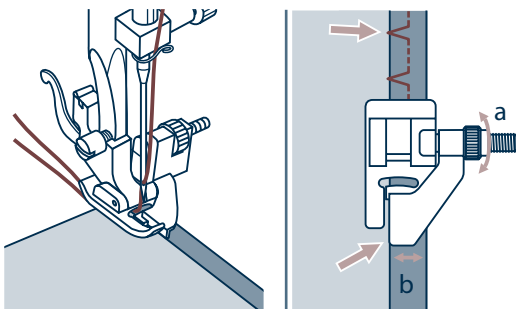

Place the fabric under the foot. Turn the handwheel forwards by hand until the needle swings fully to the left. It should just pierce the fold of the fabric. If it does not, adjust the stitch width accordingly.

Adjust the guide (b) by turning the knob (a) so that the guide just rests against the fold.

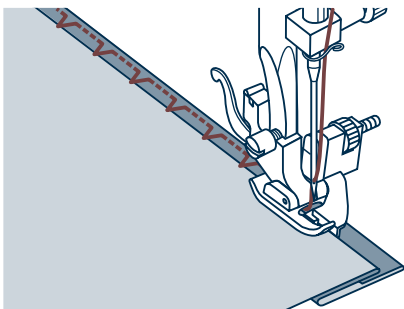

Sew slowly, guiding the fabric carefully along the edge of the guide.

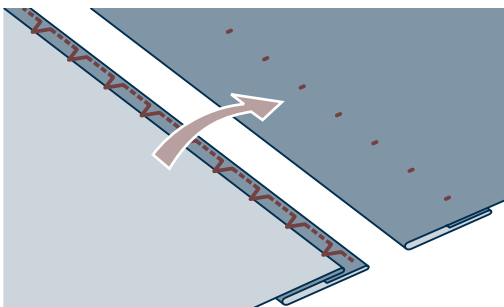

Turn over the fabric.

BUTTON SEWING

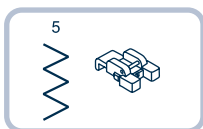

Change the presser foot to the button sewing foot.

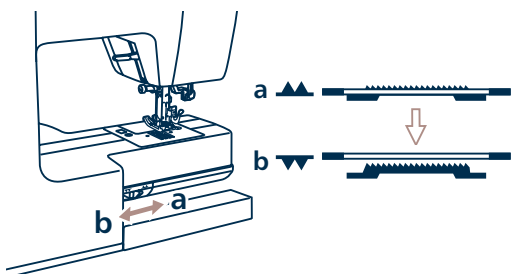

Move the drop feed control to "▼" to lower the feed dogs.

03

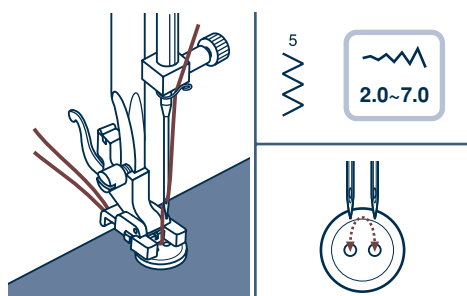

Position the work under the foot. Place the button in the desired position, lower the foot.

Select zig zag pattern. Adjust the stitch width to "2.0-7.0" according to the distance between the two holes of the button.

Turn the handwheel to check that the needle goes cleanly into the left and right holes of the button.

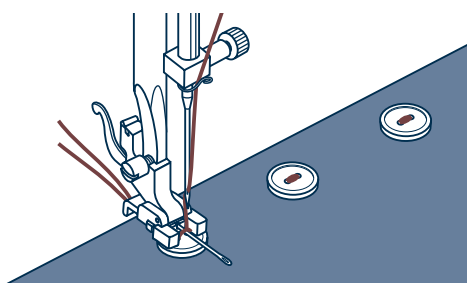

Before sewing, press the Auto-lock button to sew reinforcement stitches automatically at the beginning and at the end of the stitch.

If a shank is required, place a darning needle on top of the button and sew.



For buttons with 4 holes, sew through the front two holes first, push work forward and then sew through the back two holes.

BUTTONHOLE STITCHING

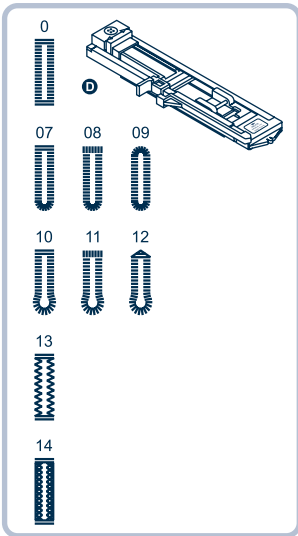

0	2.5~7.0	0.3~1.0
07	2.5~5.5	0.3~1.0
08	5.5~7.0	0.3~1.0
09	3.0~7.0	1.0~2.0
10	3.0~7.0	1.0~3.0
11		
12		
13		
14		

- 0: For thin or medium fabric
- 07: For thin or medium fabric
- 08: For horizontal buttonholes on thick fabrics
- 09: For thin or medium fabric
- 10: For suits or overcoats
- 11: For thick coats
- 12: For jeans or trousers
- 13: For jeans or stretch fabric with a coarse weave
- 14: For stretch fabric

➔ Please Note:

Before sewing a buttonhole on your project, practice on a scrap piece of the same type of fabric.

03

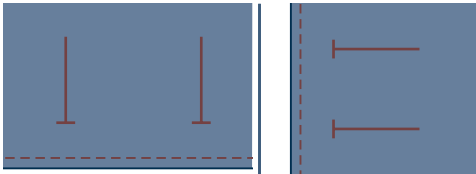

Mark the positions of the buttonhole on the fabric. The maximum buttonhole length is 3cm (1 3/16 inch). (Total of diameter + thickness of button.)

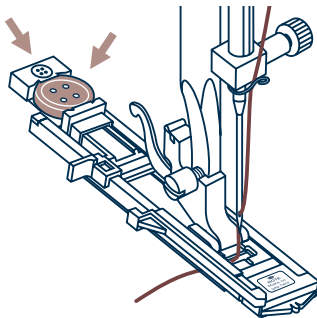

Attach the buttonhole foot, then pull out the button holder plate and insert the button. The size of the buttonhole is determined by the button inserted in the button plate.

The thread should be passed through the hole in the presser foot, then be placed under the foot.

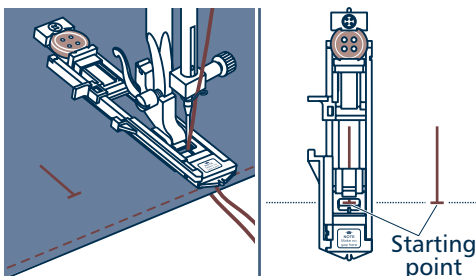

Select the buttonhole stitch.

Adjust the stitch width and the stitch length to the desired width and density.

BUTTONHOLE STITCHING

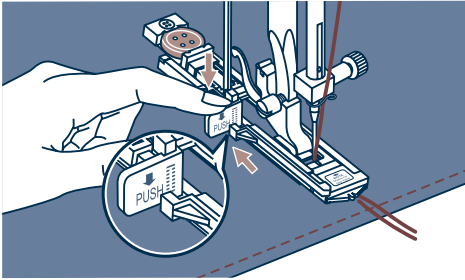

Position the fabric under the presser foot so that the centerline's mark is aligning with the center of the buttonhole foot.

Lower the buttonhole lever, then push it to the back.

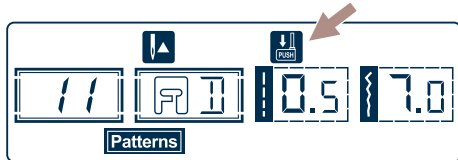

➔ Please Note:

When you select any buttonhole pattern, LCD screen will be demonstrated the figure "🔽", it is to remind you to lower the buttonhole lever.

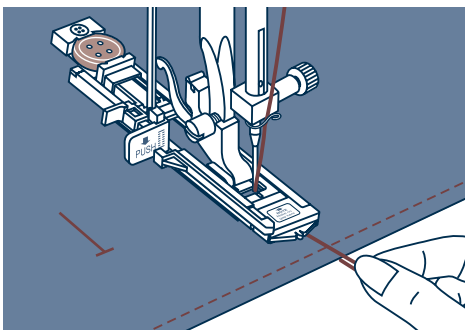

While lightly holding the end of upper thread and start sewing.

➔ Please Note:

Gently feed the fabric by hand. Before stopping, the machine will automatically sew a reinforcement stitch after the buttonhole is sewn.

* Buttonholes are sewn from the front of the presser foot to the back, as shown.

BUTTONHOLE STITCHING

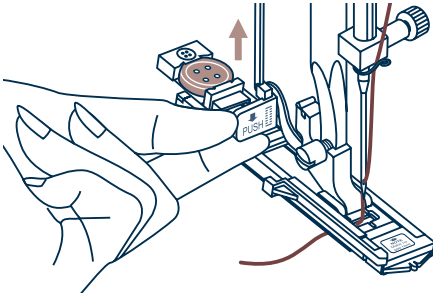

Raise the presser foot and cut thread.

To sew over same buttonhole, raise the presser foot (will return to original position).

After sewing the buttonhole stitch, raise the buttonhole lever until it stops.

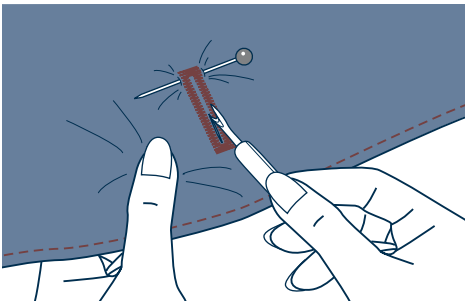

Cut the center of the buttonhole being careful not to cut any stitches on either side. Use a pin as a stopper at the bar tack so you do not cut too much.

03

Making a buttonhole on stretch fabrics

When sewing buttonholes on stretch fabric, hook heavy thread or cord under the buttonhole foot.

Attach the buttonhole foot and hook the gimp thread onto the back of the presser foot.

Bring the two gimp thread ends to the front of the foot and insert them into the grooves, then temporarily tie them there. Lower the presser foot and start sewing.

Set the stitch width to match the diameter of the gimp thread.

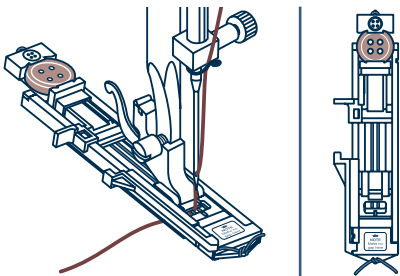

Once sewing is completed, pull the gimp thread gently to remove any slack, then trim off any excess.

➔ Please Note:

It is suggested that you use interfacing on the backside of the fabric.

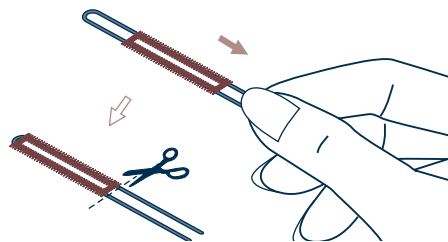

EYELET STITCH

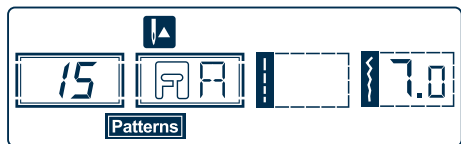
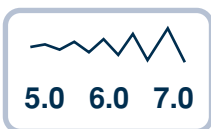

15: Select for sewing eyelets on belts , etc

Select pattern 15 to get the eyelet stitch.
Attach satin stitch foot (A).

03

Press the "-" or "+" stitch width adjustment to button select the eyelet size.

Size of eyelet.

A. Large: 7.0mm (1/4 inch).

B. Medium: 6.0mm (15/64 inch).

C. Small: 5.0mm (3/16 inch).

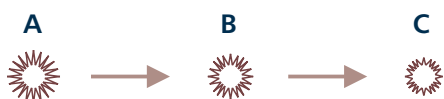

Lower the needle into the fabric at the beginning of the stitching, and then lower the presser foot lever.

Once sewing is completed, the machine automatically sews reinforcement stitches, then stops.

Make a hole at the center using an eyelet punch.

* Eyelet punch is not included with the machine.

➔ Please Note:

If thin thread is used, the stitching may be coarse. If this occurs, sew the eyelet twice one on top of the other.

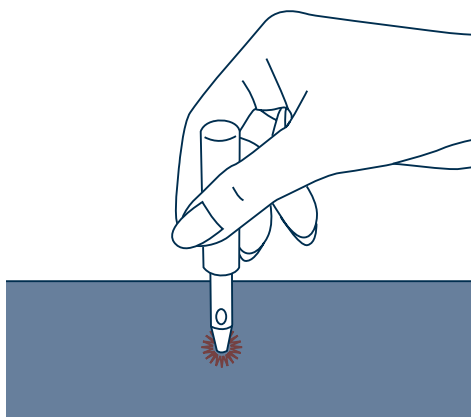

DARNING STITCH

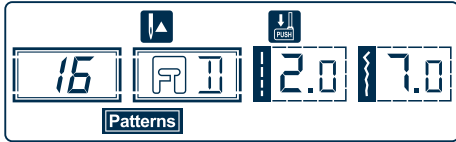
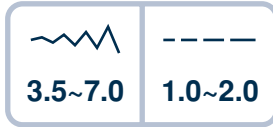
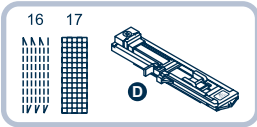

Select pattern 16 or 17 to get the darning stitch. Change the presser foot to the buttonhole foot.

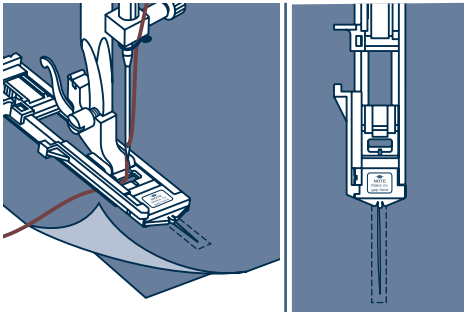

Baste the upper fabric and the under fabric together.

Select the needle position. Lower the presser foot over the center of the tear.

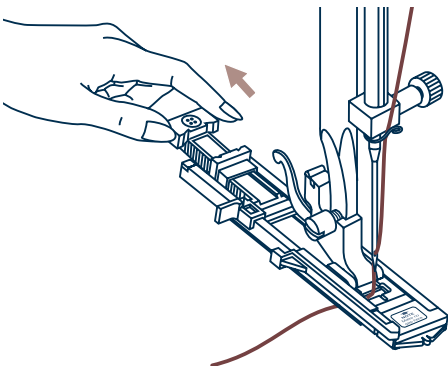

Pull the button holder to rear.

Set the button guide plate on buttonhole foot to the desired length.

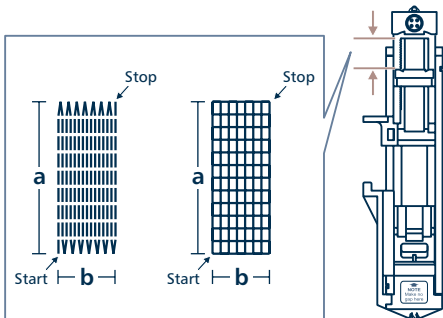

The size of one darn cycle is variable.

However, the maximum stitch length is 2.6cm (1 inch) and the maximum stitch width is 7mm (9/32 inch).

a. The length of sewing.

b. The width of sewing.

DARNING STITCH

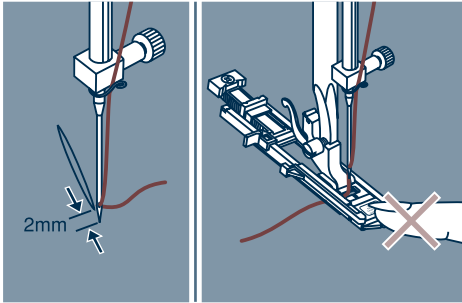

5. Position the fabric so that the needle is 2mm (1/16 inch) in front of the area to be darned, and then lower the presser foot lever.

Please Note:

When lowering the presser foot, do not push in the front of the presser foot, otherwise the darning will not be sewn with the correct size.

03

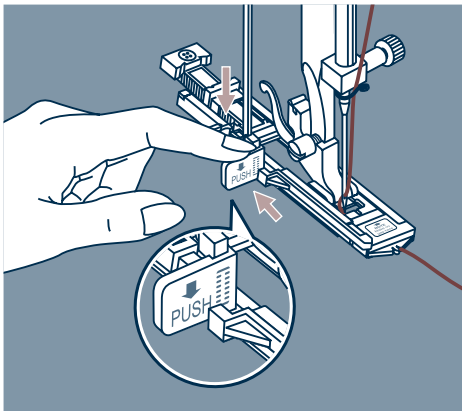

Pass the upper thread down through the hole in the presser foot. Pull down the buttonhole lever then push it back. The buttonhole lever is positioned behind the bracket on the buttonhole foot. Gently hold the end of the upper thread in your left hand, and then start sewing.

Please Note:

When you select any buttonhole pattern or darning pattern, LCD screen will show the figure " ", it is to remind you to lower the buttonhole lever.

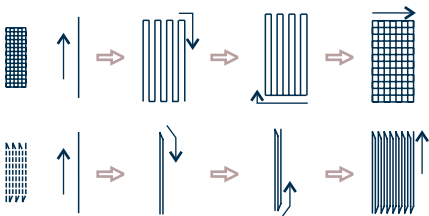

Darning stitches are sewn from the front of the presser foot to the back, as shown.

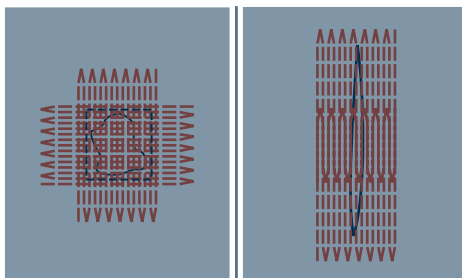

If the sewing range is too big to sew, then we suggest you can sew several times (or cross sew) to get better sewing result.

ZIPPER INSERTION

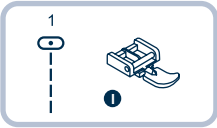

⚠ Attention:
 Zipper foot should be used for sewing width center needle position straight stitch only. It is possible that needle could hit the presser foot and break when sewing other patterns.

Inserting a centered zipper

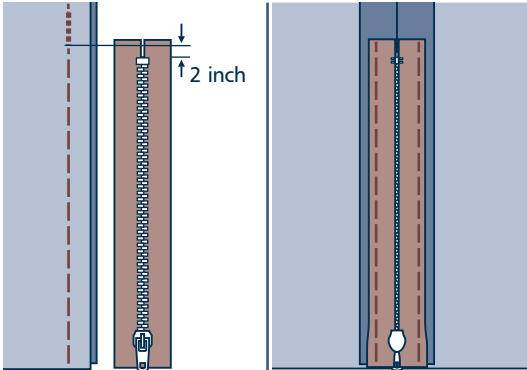

- Baste the zipper opening on the garment.

- Press open the seam allowance. Place the zipper face down on the seam allowance with the teeth against the seam line. Baste the zipper tape.

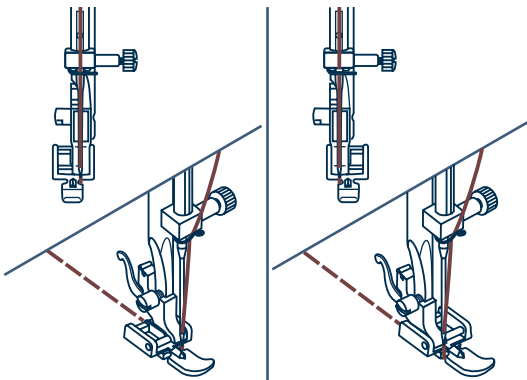

- Attach the zipper foot. Attach the right side of the presser foot pin to the holder when sewing the left side of the zipper.

- Attach the left side of the presser foot pin to the presser foot holder when sewing the right side of the zipper.

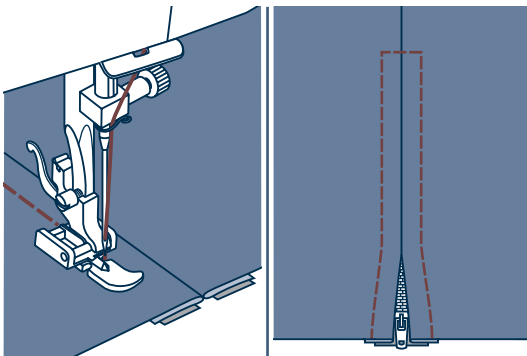

- Stitch left side of the zipper from top to bottom.

- Stitch across the lower end and right side of zipper. Remove the basting and press.

ZIPPER INSERTION

03

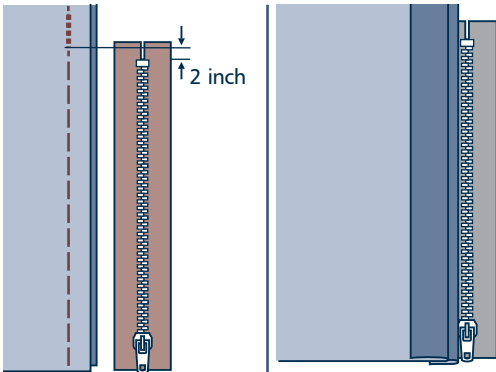

Inserting a side zipper

- Baste the zipper opening on the garment.
- Fold back to the left seam allowance. Turn under the right seam allowance to form 3mm (1/8 inch) fold.

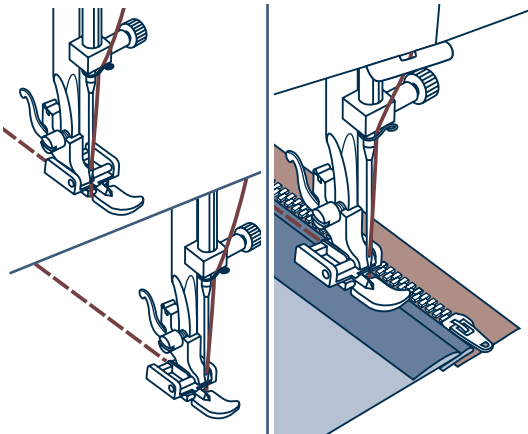

- Attach the zipper foot. Attach the right side of the presser foot pin to the holder when sewing the left side of the zipper. Attach the left side of the presser foot pin to the presser foot holder when sewing the right side of the zipper.

- Stitch the left side of zipper from bottom to top.

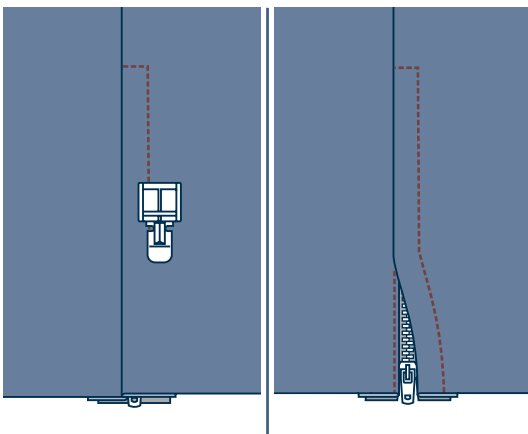

- Turn the fabric right side out, stitch across the lower end and right side of zipper.
- Stop about 5cm (2 inches) from the top of zipper. Remove the basting and open the zipper. Stitch the remainder of the seam.

NARROW HEMMING

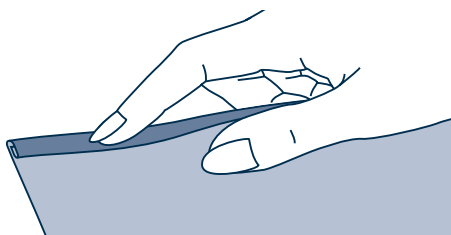
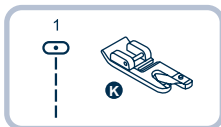

Fold edge of fabric over about 3mm (1/8 inch), then fold it over again 3mm (1/8 inch) for about 5cm (2 inches) along the edge of the fabric.

03

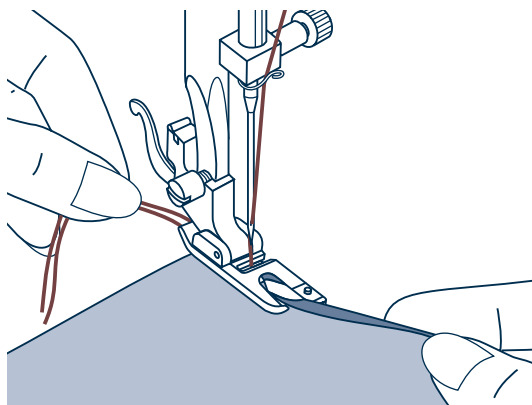

Insert the needle into the fold by rotating the handwheel toward you, and lower the presser foot. Sew several stitches and raise the presser foot.

Insert the fabric fold into the spiral opening of hemmer foot. Move fabric back and forth until the fold forms a scroll shape.

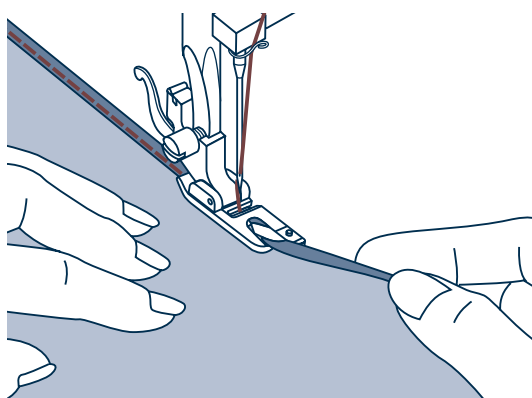

Lower the presser foot and start sewing slowly guiding the raw edge of the fabric in front of the hemmer foot evenly into the scroll of the foot.

CORDING

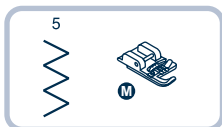

Sew over one strand of cording to create a pretty swirled design on a jacket or vest or sew over three strands of cording for border trims. Pearl cotton, knitting yarn, embroidery floss, lace thread, fine wool or lily yarn can be used for cording.

03

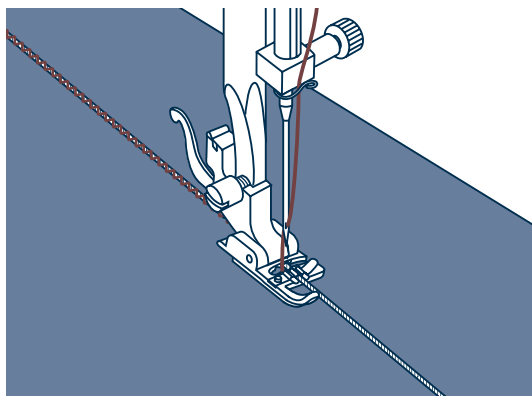

Single cording

Mark the design on the fabric. Insert the cord in the center groove of the cording foot from the right side opening. Pull the cord about 5cm (2 inches) behind the foot.

The grooves under the foot will hold the length of the cord in place while the stitches are being formed over the cord.

Select the stitch and adjust the stitch width so that the stitches are just covering the cord. Lower the foot and sew slowly, guiding the cord over the design.

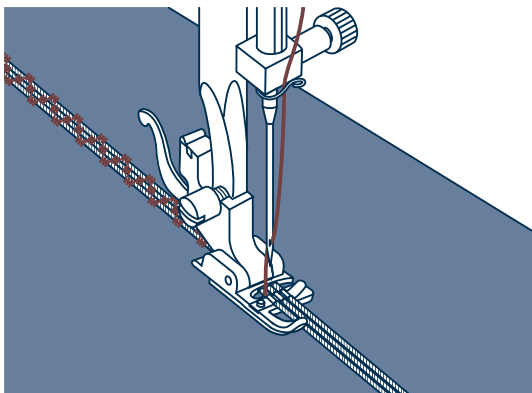
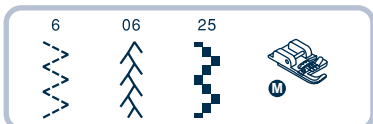

Triple cording

Push the sewing thread to the left and insert three cords into the grooves of the foot and pull about 5cm (2 inches) of the cords behind the foot.

Select the desired pattern and adjust the stitch width so that the stitches are just covering the cords. Lower the foot and sew slowly guiding the cords.

SATIN STITCH SEWING

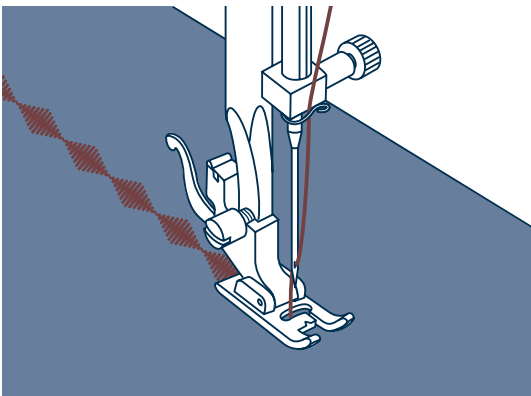
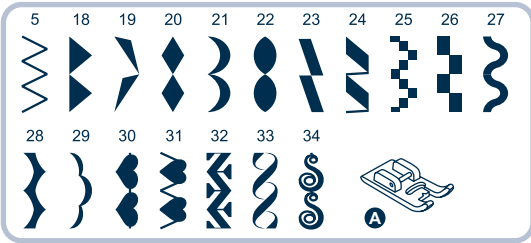

Use the satin stitch foot for satin stitching and sewing decorative stitches. This foot has a full indentation on the underside to allow easy sewing over the thickness of the stitches formed by closely spaced zigzag stitches, and even feeding of the fabric.

To tailor the satin or decorative stitch pattern, you may adjust the length and width of the pattern by pressing the stitch length and width adjustment buttons. Experiment with fabric scraps until you get the desired length and width.

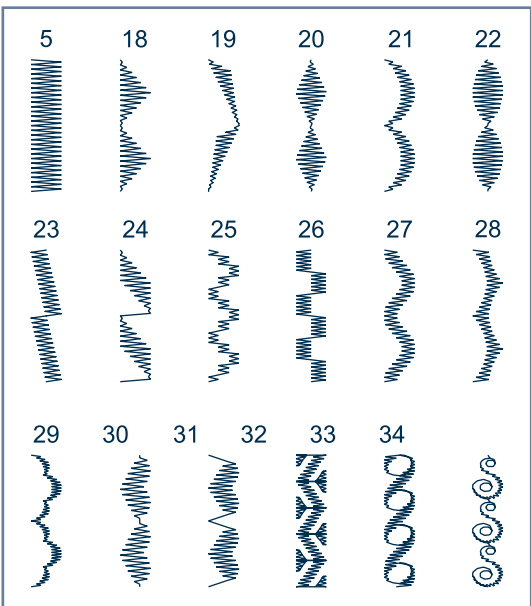

➔ Please Note:

When sewing very thin fabrics, it is suggested that you use interfacing on the backside of the fabric.

QUILTING

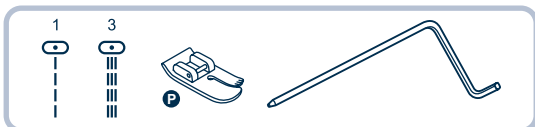

	
3.5	1.0~3.0

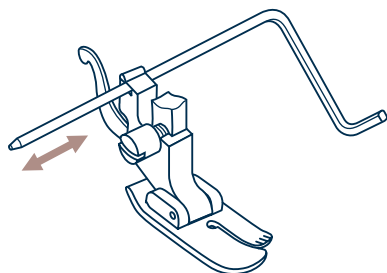

Insert the quilting guide in the presser foot holder as illustrated and set the space as you desire.

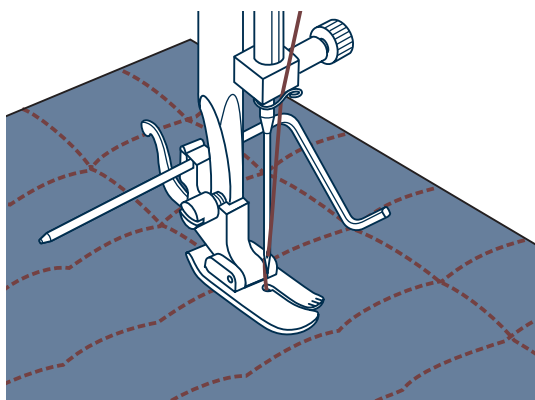

Sew the first row and move over the fabric to sew successive rows with the guide riding along the previous row of stitching.

SCALLOP STITCH

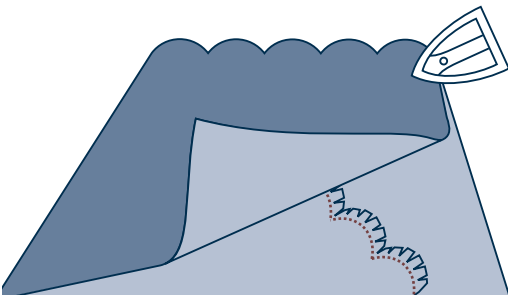
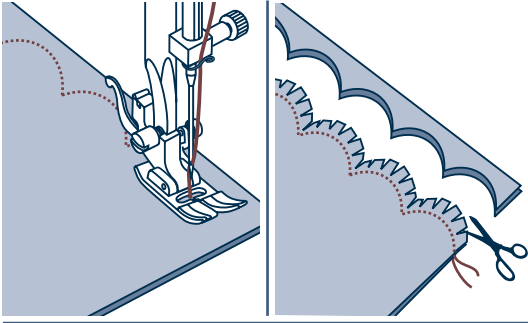

Scalloped hem

- Fold the fabric right side together in and sew along the edge.
- Cut the fabric along the seam leaving an allowance of 3mm (1/8 inch) for seaming. Notch the allowance.
- Turn the fabric over and push out the curved seam to the surface and iron it.

03

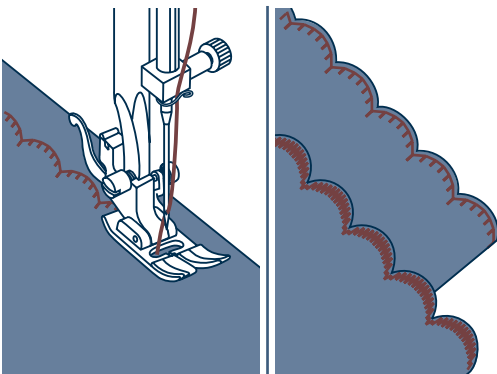
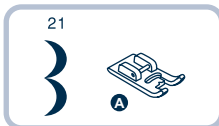
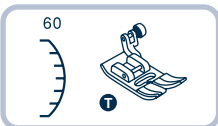

Scalloped edging

- Stitch along the edge of the fabric, making sure not to sew directly on the edge of the fabric.
For better results, apply spray starch onto the fabric and press with a hot iron before it is sewn.
- Trim along the stitches.
Be careful not to cut the stitches.

45

GATHERING



03

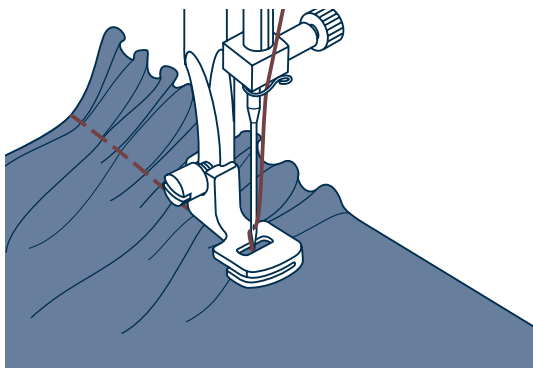

Gathered fabric

Remove the presser foot holder and attach the gathering foot, lowering the tension setting to below 2.

Place fabric to be gathered under presser foot to the right of the presser foot. Sew a row of stitching, keeping the raw edge of fabric aligned with the right edge of foot.

The stitches automatically cause the fabric to gather. Suitable for light to medium weight fabrics.

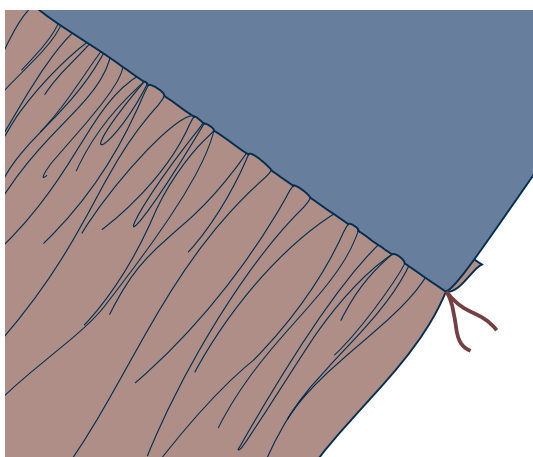
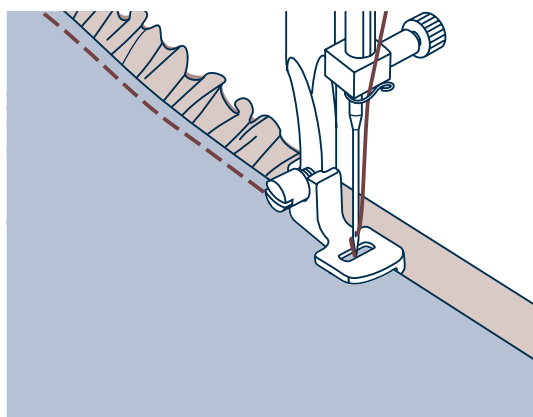

To gather and attach gathered fabric in one step

Look closely at the gathering foot to see a slot on the bottom.

When using the slot, you can gather the bottom layer of the fabric while attaching it to a flat top layer, such as the waistband on a dress bodice.

1. Remove the presser foot holder and attach gathering foot.
2. Place the fabric to be gathered with right side up under the foot.
3. Place top layer of the fabric right side down in the slot.
4. Guide the two layers as illustrated.

Note:

- When testing machine for adjustments to achieve desired fullness, work with 10" increments of the fabric, trims or elastic. This makes it easier to determine the adjustments and how much change is needed for your project. Always test on your project fabric and on the same grainline as will be used in your finished project.

Using the crossgrain of the fabric will make prettier gathers than the straight of grain.

- Sew slow to medium speed for better fabric control.

SMOCKING

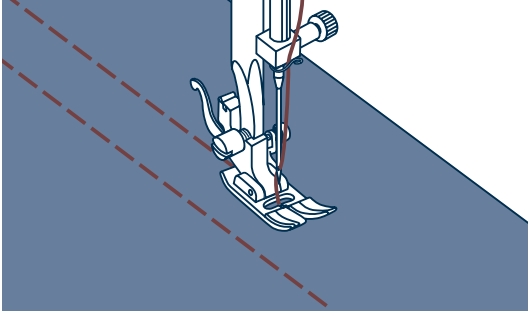
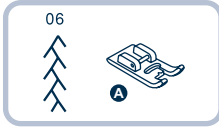
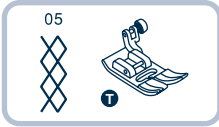

Adjust the stitch length to 4.0mm and loosen the thread tension.

Use the all purpose foot to sew straight lines 1cm (3/8 inch) apart, across the area to be smocked.

03

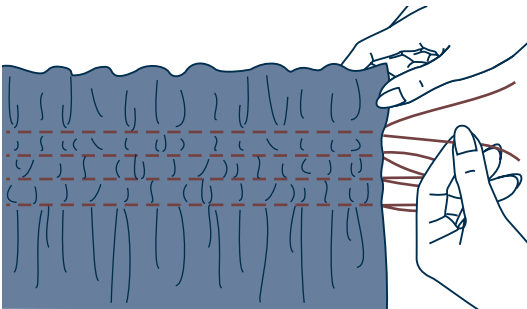

Knot the threads along one edge. Pull the bobbin threads and distribute the gathers evenly. Secure the threads at the other end.

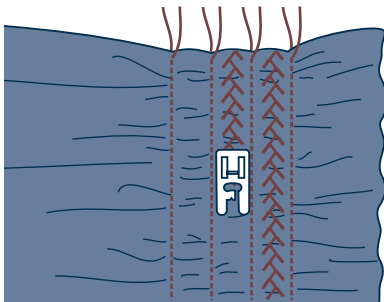

Reduce the tension, if necessary and sew decorative pattern stitches between the straight seams.

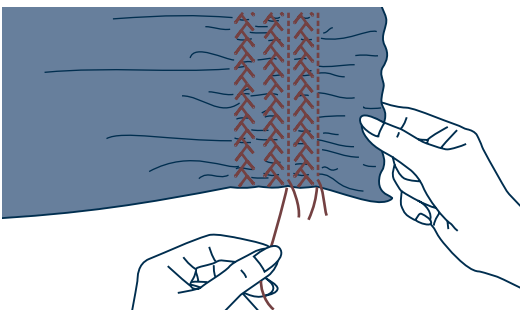

Pull out the gathering stitches.

47

FREE MOTION DARNING, EMBROIDERY AND MONOGRAMMING

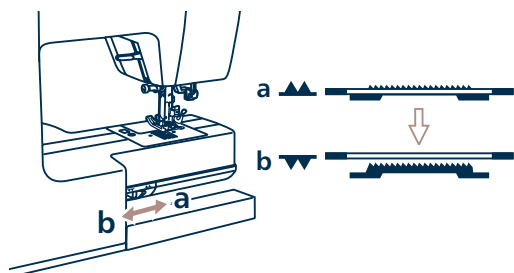

Move the drop feed control to "▼" to lower the feed dogs.

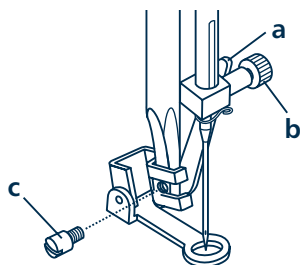

Remove the presser foot holder, and attach the darning foot to the presser foot holder bar. The lever (a) should be behind the needle clamp screw (b). Press the darning foot on firmly from behind with your index finger and tighten the screw (c).

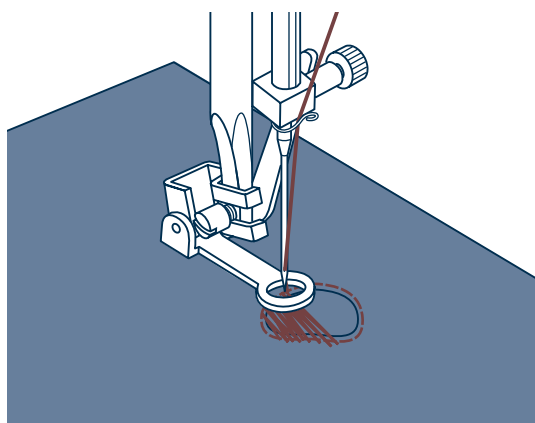

Darning

First sew around the edges of the hole (to secure the threads). Working from left to right, sew over the hole in a constant and continuous movement. Turn the work by 1/4 and sew over the first stitching moving the work slower over the hole to separate the threads and not form big gaps between the threads.

➡ Please Note:

Free motion darning is accomplished without the sewing machine internal feed system. Movement of the fabric is controlled by the operator. It is necessary to coordinate sewing speed and movement of fabric.

FREE MOTION DARNING, EMBROIDERY AND MONOGRAMMING

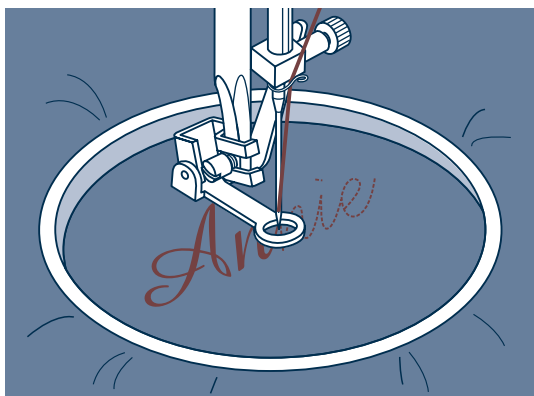
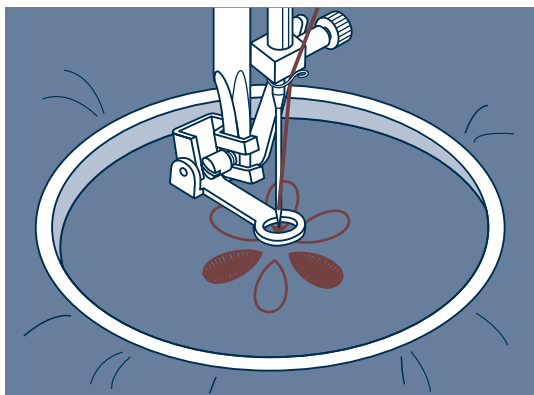
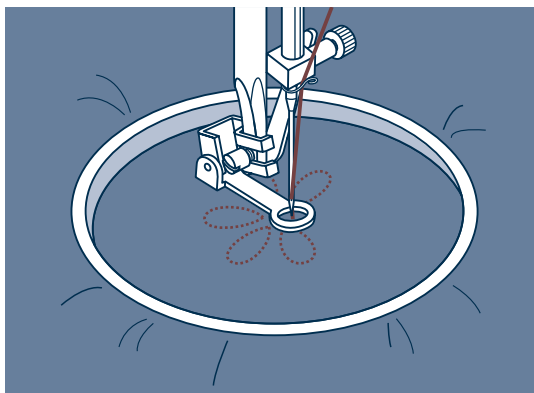

Embroidery

Select zigzag stitch pattern and adjust the stitch width as desired.

Stitch along the outline of the design by moving the embroidery hoop. Make sure to maintain a constant speed.

Fill in the design working from the outline towards the inside. Keep the stitches close together.

You will get longer stitches by moving the hoop faster and shorter stitches by moving the hoop more slowly.

Secure with a reinforcement stitches at the end by pressing the Auto-lock button.

Monogramming

Select the zigzag stitch pattern and adjust the stitch width as desired. Sew at a constant speed, moving the hoop slowly along the lettering.

When the letter is finished. Secure with a reinforcement stitches at the end by pressing the Auto-lock button.

* Embroider hoop is not included with the machine.

FAGOTING

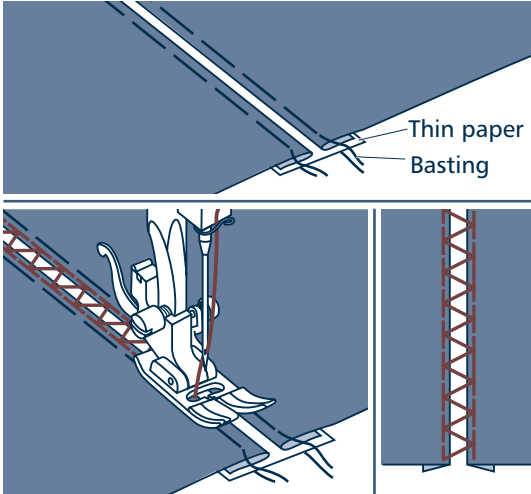
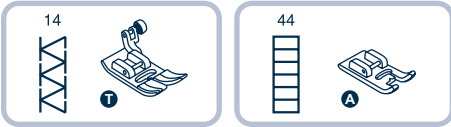

1. Separate the folded edges of the fabric pieces with a gap of 4mm (1/8 inch) and baste them onto a piece of thin paper or water-soluble stabilizer sheet.
2. Align the center of the presser foot with the center of the two pieces of fabric and begin sewing.
3. After sewing, remove the paper.

PATCHWORK STITCHING

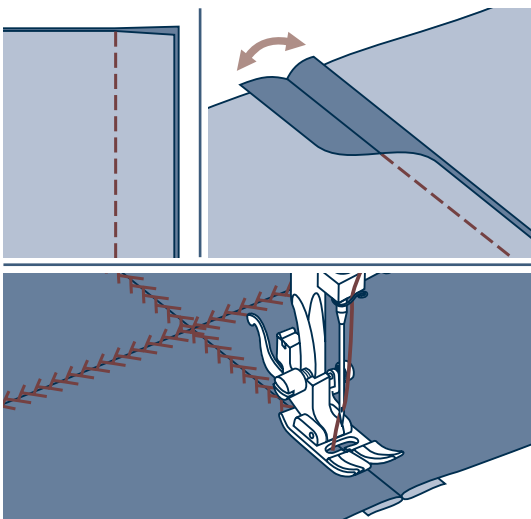
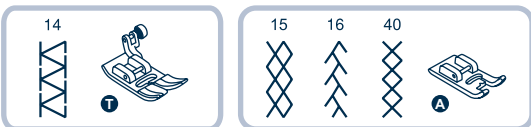

1. Place the two pieces of fabric with the right side together and sew with the straight stitch.
2. Open the seam allowance and press it flat.
3. Place the center of the presser foot on the seam line of the joined pieces of fabric and sew over the seam.

MIRROR

➔ Please Note:

- The Direct Pattern 00 and the Patterns 07-17 cannot be mirror imaged.
- Mirror imaged patterns can also be combined with other patterns.

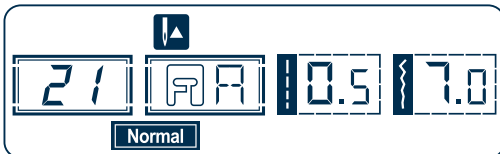

Select the pattern.

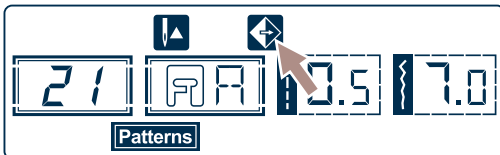

Pressing the mirror button.

LCD will display the mirror function and the machine will sew the reflected pattern until you press the mirror button again.

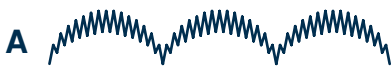
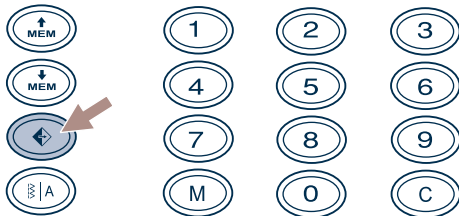

A. Normal pattern sewing.

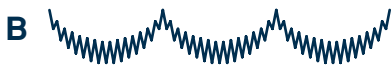

B. Mirror pattern sewing.

TWIN NEEDLE



* The Twin needle accessory is optional. It is not included with this machine.

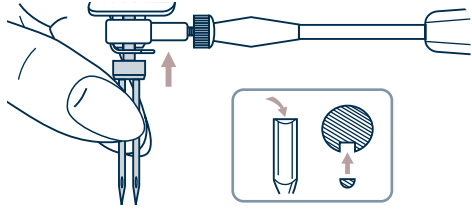

Insert the twin needle.

⚠ Attention:

Use only the twin needle type included. Use of any other twin needle type may result in the needle being bent or damage to the machine. Never use bent needles. Bent needles can easily break, possibly result in injuries.

03

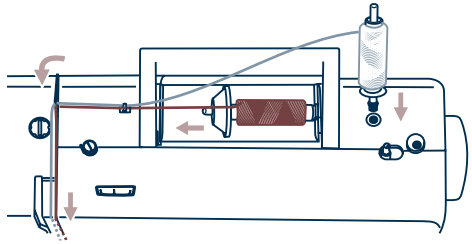

Follow the instructions for single-needle threading using the horizontal spool pin. Thread through the left needle. Set the second spool pin into the hole on the top of the machine. Thread through all the threadguide points, making certain to omit the thread guide above the needle and pass thread through the right needle.

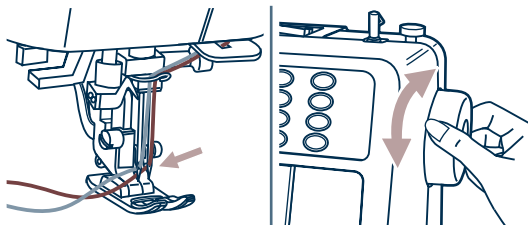

Thread each needle separately.

➡ Please Note:

Make sure that the two threads used to thread the twin needle are of the same weight. You can use one or two colors.

Before sewing adjust the stitch width, Turn the handwheel to check the needle clearance, so that needle does not hit the needle plate.

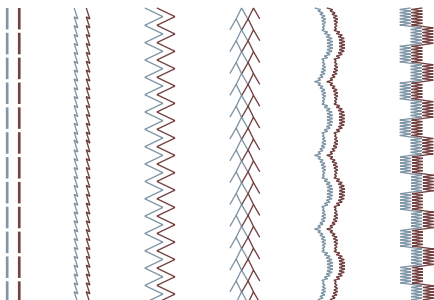

Select a stitch pattern and start to sewing.

The Direct Pattern 00 and the Patterns 07-17 cannot be used. Sewing result will be a pattern with two parallel stitch lines.

➡ Please Note:

When sewing with twin needle, always proceed slowly, and make sure to maintain a low speed to insure quality stitching.

WALKING FOOT

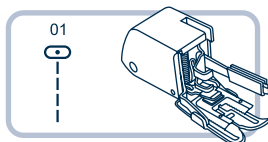

* The walking foot accessory is optional. It is not included with this machine.

Always try to sew first without the walking foot accessory which should be used only when necessary.

It is easier to guide the fabric and you have a better view of the seam when using the standard, regular foot on your machine. Your sewing machine offers excellent stitch quality on a wide range of fabrics from delicate chiffons to multiple layers of denim. The Walking Foot accessory equalizes the feeding of the upper and lower layers of fabric and improves the matching of plaids, stripes and patterns. It also helps to prevent uneven feeding of very difficult fabrics. The Walking Foot accessory equalizes the feeding of the upper and lower layers of fabric and improves the matching of plaids, stripes and patterns. It also helps to prevent uneven feeding of very difficult fabrics.

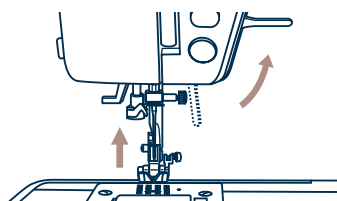

Lift the presser foot lifter to raise the presser foot bar.

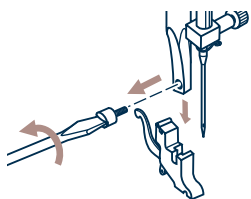

Remove the presser foot holder by unscrewing (counterclockwise) the presser bar attaching screw.

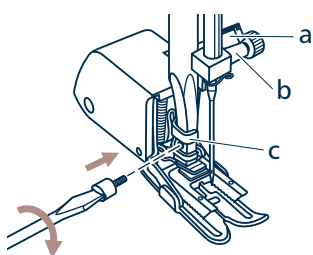

Attach the Walking Foot to the machine as follows:

- The arm (a) should fit into above the needle screw and clamp (b).
- Slide the plastic attaching head (c) from your left to right so that it is fitted into the presser foot bar.
- Lower the presser foot bar.
- Replace and tighten (clockwise) the presser bar attaching screw.
- Make sure both the needle screw and the presser bar attaching screw are tightly secured.

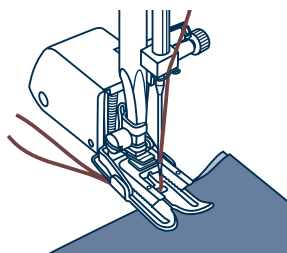

Draw the bobbin thread up and place both the bobbin thread and the needle thread behind the walking foot attachment.

MEMORY

Combined patterns can be stored for later use. Since stored patterns are not lost after the sewing machine is turned off, they can be recalled at any time.

This is convenient for patterns, such as names, that will be used often.

➔ Please Note:

- The machine has a program memory that can retain 30 units of stitches.
- Multiple patterns selecting from pattern modes " **Patterns** " , " **Alphabet** " can be combined and sewn together.
- All the units in the memory can be edited to set its function such as Stitch length, Stitch width, Mirror and Auto-lock.
- The Direct mode patterns and buttonholes can not be memorized.

Combining patterns or letters

1. When you turn the machine "ON", the LCD screen displays " **Direct** ".



2. Press the " **M** " button to enter the memory mode, and store the combinations of character or decorative stitches.

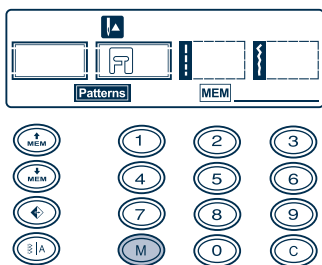

3. Press the " **M** " button to select any desired pattern group among " **Patterns** " or " **Alphabet** " on the LCD screen. Then press the desired pattern number (E.g.03). (You can change the stitch length, width, or choose the Auto-stop, mirror function if desired.)

Repeat this step for more patterns to be stored in the memory.

➔ Please Note:

When the memory is full with 30 units of patterns, the machine will beep to signal it.

MEMORY

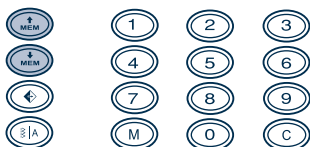
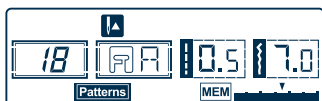

4. Use the arrow " " or " " button to check what you have programmed.

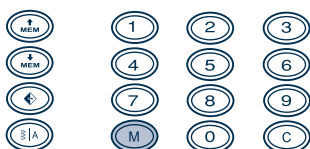



5. Press the " " button to leave the memory mode and return to the Direct mode.

Attention:

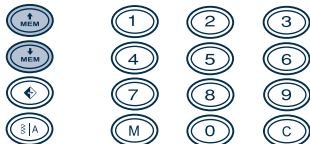
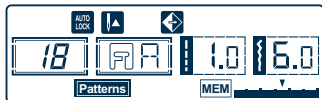
The selected pattern will be cleared from the memory module after closing the machine if you do not press the " " button again when you have completed your selection.



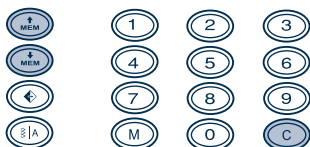
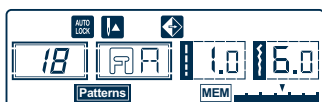

Adding patterns or letters

While in the memory mode, press the " " button or the " " button until the stitch number you have selected is displayed, then add the new stitch or change the stitch length, width, Auto-stop or mirror, if desire.



Clearing patterns or letters

If you wish to delete a certain stitch within in the memory mode, use the " " button or " " button until the actual stitch number is displayed.

Press the " " button to delete the selected pattern and the next pattern in the back will move forward.

MEMORY

Recalling and sewing the memorized pattern

1. Press the "M" button to enter the memory mode.
The machine will be positioned at the first programmed stitch.

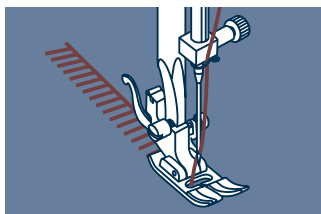
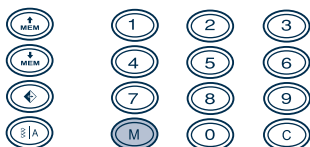
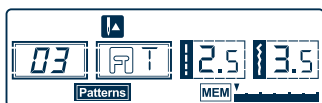

2. Press foot controller. The machine will start to sew from first entered pattern. On the LCD screen, sewing stitch data is indicated.

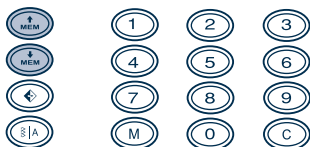
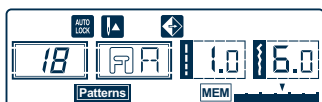

3. If you wish to check what is programmed or if you wish to start sewing a few stitches in the memory mode, use the "MEM+" button or "MEM-" button.

You can use the Auto-lock "A" function when the sewing machine is stopped.

➔ Please Note:

If you wish to repeat your stitch combination without having the machine stop press the Auto-lock "A" button to cancel the Auto-Stop in the memory mode. The "A" will disappear from the LCD screen.

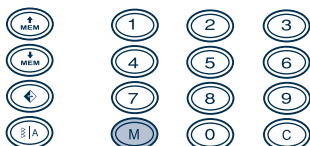

4. Press the "M" button to leave the memory mode and return to the Direct mode.

WARNING FUNCTIONS

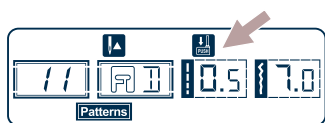

Warning animation message display

BH lever is not lowered

The buttonhole or darning stitch was selected and press on the foot control while the buttonhole lever is raised.



Instruction animation message display

Bobbin winding

The bobbin winder is winding the bobbin.



Warning beeping sound

- When operating correctly: 1 beep
- When the memory is full 30 units of pattern: 2-short beeps
- When operating incorrectly: 3-short beeps
- When the sewing machine is in trouble and can't sew : 8 seconds short beeps.

It means that the thread is twisted or jammed and the hand wheel axle can't move. Please look through the "Trouble shooting guide" on page 61/62 to find the solution. After the problem has been solved, the machine will continue to sew.

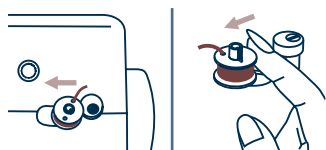

Return bobbin winder stopper to right

If you press any button on the machine when the bobbin is full or the bobbin winder is in the right position, then the machine will beep 3 times as a warning. Return the bobbin winder stopper to the left position.

➔ Please Note:

If the problem is still not solved, please contact your local dealer.

⚠ Attention:

During the sewing, if the thread get jammed inside the hook stopping the needle from moving and you continue pressing the foot control, the security switch will stop the machine completely. In order to restart the sewing machine, you will have to turn the on/off switch to the OFF position and then ON again.

REPLACING THE LIGHT BULB

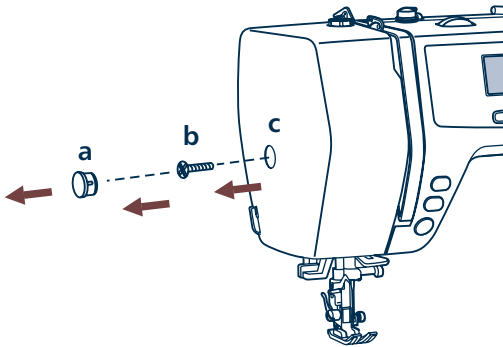

1. Remove plug (a), loosen the screw (b) on the left side of the sewing head and remove the face plate (c).

Attention:

Turn the power switch off and wait until the lamp has cooled down before touching it.

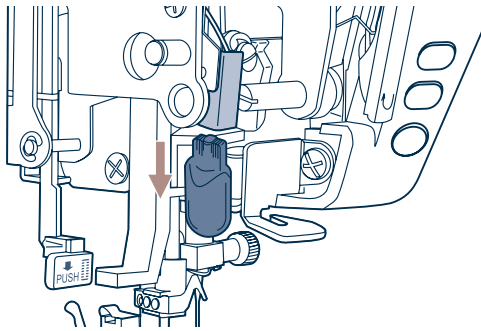

2. If the machine is equipped with a 5W lamp, replace the bulb as follows:

Pull light bulb downward to remove.

Replace the bulb with same type rated 5W.

Replace the face plate and tighten the screw.

MAINTENANCE

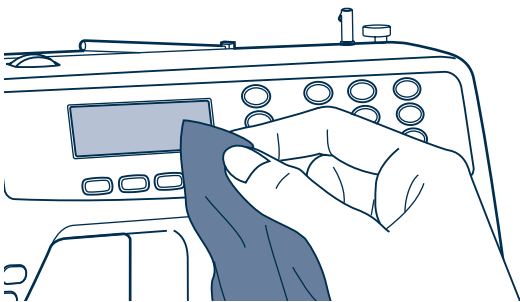

Cleaning the screen

If the front panel is dirty, wipe it gently with a soft, dry cloth.

Do not use any organic solvents or detergents.

Attention:

Disconnect the power cord from the wall socket before cleaning the screen and sewing machine surface, otherwise injury or electrical shock may result.

Cleaning the sewing machine surface

If the surface of the sewing machine is dirty, lightly soak a cloth in mild detergent, squeeze it out firmly and then wipe the surface. After cleaning it once in this way, wipe the surface again with a dry cloth.

MAINTENANCE

Cleaning the hook

If lint and bits of thread accumulate in the hook, this will interfere with the smooth operation of the machine. Check regularly and clean the stitching mechanism when necessary.

Attention:

Disconnect the machine from the wall outlet before carrying out any maintenance.

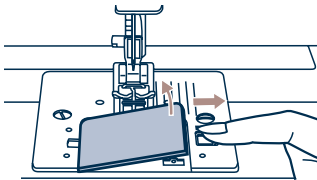

1. Remove the bobbin cover plate and bobbin.

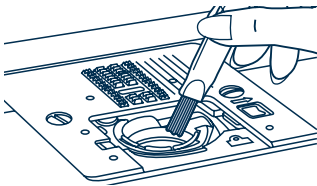

2. Clean the bobbin holder with a brush.

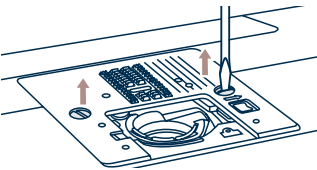

3. Remove the needle, presser foot and presser foot holder. Remove the bobbin cover plate and bobbin. Remove the screw holding the needle plate and remove the needle plate.

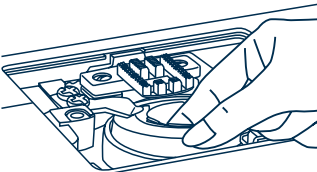

4. Lift up the bobbin case and remove it.

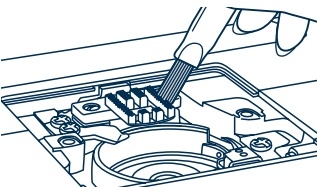

5. Clean the hook race, feed dog and bobbin case with a brush. Also clean them, using a soft, dry cloth.

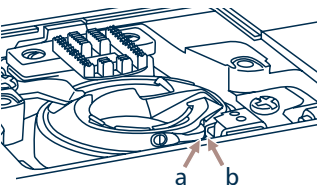

6. Replace the bobbin case into the hook race so that the tip (a) fits to the stopper (b) as shown.

TROUBLE SHOOTING GUIDE

Before calling for service, check the following items. If the problem still persists, contact the place of purchase or your nearest authorized dealer.











Problem	Cause	Correction	Reference
Upper thread	1.The machine is not threaded correctly.	1.Rethread the machine.	Page 16
	2.The thread tension is too tight.	2.Reduce the thread tension. (lower number).	Page 22
	3.The thread is too thick for the needle.	3.Select a larger needle.	Page 21
	4.The needle is not inserted correctly.	4.Remove and reinsert the needle (flat side towards the back).	Page 20
	5.The thread is wound around the spool holder pin.	5.Remove the reel and wind thread onto reel.	Page 16
	6.The needle is damaged.	6.Replace the needle.	Page 21
Lower thread breaks	1.The bobbin case is not inserted correctly.	1.Remove and reinsert the bobbin case and pull on the thread. The thread should pull easily.	Page 15
	2.The bobbin case is threaded wrong.	2.Check both bobbin and bobbin case.	Page 13
	3.The lower thread tension is too tight	3.Loosen lower thread tension as described.	Page 22
Skipped stitches	1.The needle is not inserted correctly.	1.Remove and reinsert needle(flat side towards the back).	Page 20
	2.The needle is damaged.	2.Insert a new needle.	Page 20
	3.The wrong size needle has been used.	3.Choose a needle to suit the thread.	Page 21
	4.The foot is not attached correctly.	4.Check and attach correctly.	Page 62
	5.The machine is not threaded correctly.	5.Rethread the machine.	Page 16
	6.The presser foot pressure is not strong enough.	6.Adjusting the presser foot pressure.	Page 20
Needle	1.The needle is damaged.	1.Insert a new needle.	Page 20
	2.The needle is not correctly inserted.	2.Insert the needle correctly (flat side towards the back).	Page 20
	3.Wrong needle size for the fabric.	3.Choose a needle to suit the thread and fabric.	Page 21
	4.The wrong foot is attached.	4.Select the correct foot.	Page 62
	5.The needle clamp screw is loose.	5.Use the screwdriver to firmly tighten the screw.	Page 20
	6.The presser foot that is used is not appropriate for the type of stitch that you wish to sew.	6.Attach the presser foot that is appropriate for the type of stitch that you wish to sew.	Page 62
	7.The upper thread tension is too tight.	7.Loosen the upper thread tension.	Page 22
Loose	1.The machine is not correctly threaded.	1.Check the threading.	Page 16
	2.The bobbin case is not correctly threaded.	2.Thread the bobbin case as illustrated.	Page 15
	3.Needle/fabric/thread combination is wrong.	3.The needle size must suit the fabric and thread.	Page 21
	4.Thread tension is wrong.	4.Correct the thread tension.	Page 22
Seam gather or pucker	1.The needle is too thick for the fabric.	1.Select a finer needle.	Page 21
	2.The stitch length is adjusted wrong.	2.Readjust the stitch length.	Page 9
	3.The thread tension is too tight.	3.Loosen the thread tension.	Page 22

TROUBLE SHOOTING GUIDE

Problem	Cause	Correction	Reference
Seam puckering	1.The needle thread tension is too tight.	1.Lossen the thread tension.	Page 22
	2.The needle thread is not threaded correctly.	2.Rethread the machine.	Page 16
	3.The needle is too heavy for the fabric being sewn.	3.Choose a needle to suit the thread and fabric.	Page 21
	4.The stitch length is too long for the fabric.	4.Make stitch dense.	Page 9
	5.The presser foot pressure is not correctly adjusted.	5.Adjusting the presser foot pressure.	Page 20
Patterns are distorted	1.The correct presser foot is not used.	1.Select the correct foot.	Page 62
	2.The needle thread tension is too tight.	2.Loosen the thread tension .	Page 22
The machine jams	1.Thread is caught in the hook.	Remove the upper thread and bobbin case, turn the handwheel backwards and forwards by hand and remove the thread remands.	Page 59
	2.The feed dogs are packed with lint.		
The machine is noisy	1.Fluff or oil have collected on the hook	1.Clean the hook and feed dog as described.	Page 59
	2.Poor quality oil has been used.	2.Only use good quality sewing machine oil.	--
	3.The needle is damaged.	3.Replace the needle.	Page 20
	4.Slight humming sound coming from internal motor.	4.Normal.	--
	5.Thread is caught in the hook.	Remove the upper thread and bobbin case, turn the handwheel backwards and forwards by hand and remove the thread remands.	Page 59
	6.The feed dogs are packed with lint.		
Uneven stitches, uneven feed	1.Poor quality thread.	1.Select a better quality thread.	Page 21
	2.The bobbin case is threaded wrong.	2.Remove the bobbin case, the thread and reinsert correctly.	Page 15
	3.Fabric has been pulled.	3.Do not pull on the fabric while sewing, let it be taken up by the machine.	--
The sewing machine doesn't operate	1.The machine is not turned on.	1.Turn on the machine.	Page 6
	2.The presser foot lever is raised.	2.Lower the presser foot lever.	Page 25
	3.The machine is not plugged in.	3.Connect the power line plug to the electric outlet.	Page 6

QUICK ADJUSTMENT REFERENCE CHART























Direct patterns-10

Stitch Pattern	Width (mm)		Length (mm)		Presser Foot	Functions						
	Auto	Manual	Auto	Manual		Reverse	Auto-lock	Elongation	Mirror/Presser foot	Twin needle	Memory	
Utility stitches	1 	3.5	0.0~7.0	2.5	0.0~4.5	T	*	*		*	*	*
	2 	0.0	0.0~7.0	2.5	0.0~4.5	T	*	*		*	*	*
	3 	3.5	0.0~7.0	2.5	1.0~3.0	T	*	*		*	*	*
	4 	3.5	1.0~6.0	2.5	1.0~3.0	T	*	*		*	*	*
	5 	5.0	0.0~7.0	2.0	0.3~4.5	T	*	*		*	*	*
	6 	5.0	2.0~7.0	1.0	0.3~4.5	T	*	*		*	*	*
	7 	5.0	2.5~7.0	2.5	1.0~3.0	T	*	*		*	*	*
	8 	5.0	3.5~7.0	2.5	1.0~3.0	E	*	*		*/T	*	*
	9 	3.5	2.5~7.0	2.0	0.5~4.5	F	*	*		*/T	*	*
0 	5.0	2.5~7.0	0.5	0.3~1.0	D							

* : Adjustments can be made.









































04

Patterns-100





































Stitch Pattern	Width (mm)		Length (mm)		Presser Foot	Functions						
	Auto	Manual	Auto	Manual		Reverse	Auto-lock	Elongation	Mirror/Presser foot	Twin needle	Memory	
Utility stitches	00 	3.5	0.0~7.0	2.5	1.5~3.0	T	*	*		*	*	*
	01 	5.0	2.5~7.0	2.5	1.0~3.0	T	*	*		*	*	*
	02 	3.5	2.5~7.0	1.0	0.5~4.5	F	*	*		*/T	*	*
	03 	3.5	2.5~7.0	2.5	1.5~3.0	T	*	*		*	*	*
	04 	5.0	2.5~7.0	2.5	1.0~3.0	T	*	*		*	*	*
	05 	7.0	2.5~7.0	2.5	1.0~3.0	A	*	*		*	*	*
Buttonhole stitches	06 	5.0	2.5~7.0	2.5	1.0~3.0	A	*	*		*	*	*
	07 	5.0	2.5~5.5	0.5	0.3~1.0	D						
	08 	5.0	2.5~5.5	0.5	0.3~1.0	D						
	09 	5.0	2.5~5.5	0.5	0.3~1.0	D						
	10 	7.0	5.5~7.0	0.5	0.3~1.0	D						
	11 	7.0	5.5~7.0	0.5	0.3~1.0	D						
	12 	7.0	5.5~7.0	0.5	0.3~1.0	D						
Eyelet stitch	13 	6.0	3.0~7.0	1.0	1.0~2.0	D						
	14 	6.0	3.0~7.0	1.5	1.0~3.0	D						
Darning stitches	15 	7.0	7.0, 6.0, 5.0			A						
	16 	7.0	3.5~7.0	2.0	1.0~2.0	D						
Satin stitches	17 	7.0	3.5~7.0	2.0	1.0~2.0	D						
	18 	7.0	2.5~7.0	0.5	0.3~1.0	A	*	*		*	*	*
	19 	7.0	2.5~7.0	0.5	0.3~1.0	A	*	*		*	*	*
	20 	7.0	2.5~7.0	0.5	0.3~1.0	A	*	*		*	*	*
	21 	7.0	2.5~7.0	0.5	0.3~1.0	A	*	*		*	*	*

62

QUICK ADJUSTMENT REFERENCE CHART

Stitch Pattern	Width (mm)		Length (mm)		Presser Foot	Functions						
	Auto	Manual	Auto	Manual		Reverse	Auto-lock	Elongation	Mirror/Presser foot	Twin needle	Memory	
Satin stitches	22 	7.0	2.5~7.0	0.5	0.3~1.0	A	*	*		*	*	*
	23 	7.0	2.5~7.0	0.5	0.3~1.0	A	*	*		*	*	*
	24 	7.0	2.5~7.0	0.5	0.3~1.0	A	*	*		*	*	*
	25 	7.0	2.5~7.0	0.5	0.3~1.0	A	*	*		*	*	*
	26 	7.0	2.5~7.0	0.5	0.3~1.0	A	*	*		*	*	*
	27 	7.0	2.5~7.0	0.5	0.3~1.0	A	*	*		*	*	*
	28 	7.0	2.5~7.0	0.5	0.3~1.0	A	*	*		*	*	*
	29 	7.0	2.5~7.0	0.5	0.3~1.0	A	*	*		*	*	*
	30 	7.0	2.5~7.0	0.5	0.3~1.0	A	*	*		*	*	*
	31 	7.0	2.5~7.0	0.5	0.3~1.0	A	*	*		*	*	*
	32 	7.0	4.0~7.0	0.5	0.5~1.0	A	*	*		*	*	*
	33 	7.0	2.5~7.0	0.5	0.5~1.0	A	*	*		*	*	*
	34 	7.0	4.0~7.0	0.5	0.5~1.0	A	*	*		*	*	*
	Cross stitches	35 	5.0	2.5~7.0	2.5	1.0~3.0	A	*	*		*	*
36 		6.0	5.0~7.0	1.0	1.0~3.0	A	*	*		*	*	*
37 		6.0	5.0~7.0	1.0	1.0~3.0	A	*	*		*	*	*
38 		4.0	3.0~7.0	1.0	1.0~3.0	A	*	*		*	*	*
39 		4.0	3.0~7.0	1.0	1.0~3.0	A	*	*		*	*	*
40 		6.0	3.0~7.0	1.0	1.0~3.0	A	*	*		*	*	*
41 		6.0	3.0~7.0	1.0	1.0~3.0	A	*	*		*	*	*
42 		6.0	3.0~7.0	1.0	1.0~3.0	A	*	*		*	*	*
43 		6.0	3.0~7.0	1.5	1.0~3.0	A	*	*		*	*	*
44 		6.0	5.0~7.0	1.0	1.0~3.0	A	*	*		*	*	*
45 		6.0	3.0~7.0	1.5	1.0~3.0	A	*	*		*	*	*
Decorative stitches	46 	5.0	2.5~7.0	2.5	1.0~3.0	T	*	*		*	*	*
	47 	5.0	2.5~7.0	2.5	1.5~3.0	T	*	*		*	*	*
	48 	5.0	2.5~7.0	2.5	1.5~3.0	T	*	*		*	*	*
	49 	7.0	3.0~7.0	2.0	1.0~3.0	T	*	*		*	*	*
	50 	5.0	3.0~7.0	2.5	1.5~4.5	A	*	*		*	*	*
	51 	7.0	2.5~7.0	2.0	1.0~3.0	T	*	*		*	*	*
	52 	7.0	2.5~7.0	2.5	1.5~3.0	T	*	*		*	*	*
	53 	7.0	2.5~7.0	2.5	1.5~3.0	T	*	*		*	*	*
	54 	5.0	2.5~7.0	2.5	1.5~3.0	T	*	*		*	*	*
	55 	6.0	4.5~7.0	2.0	1.5~3.0	T	*	*		*	*	*
	56 	5.0	2.5~7.0	2.5	1.5~3.0	T	*	*		*	*	*
	57 	7.0	2.5~7.0	1.5	1.0~3.0	A	*	*		*	*	*
	58 	6.0	3.5~7.0	1.5	1.5~3.0	A	*	*		*	*	*
	59 	7.0	2.5~7.0	2.5	1.0~3.0	T	*	*		*	*	*
	60 	7.0	2.5~7.0	2.5	1.0~4.5	T	*	*		*	*	*
	61 	7.0	3.5~7.0	2.5	2.0~3.0	A	*	*		*	*	*
	62 	7.0	3.5~7.0	2.0	1.0~3.0	T	*	*		*	*	*

QUICK ADJUSTMENT REFERENCE CHART

Stitch Pattern	Width (mm)		Length (mm)		Presser Foot	Functions					
	Auto	Manual	Auto	Manual		Reverse	Auto-lock	Elongation	Mirror/Presser foot	Twin needle	Memory
63 	6.0	5.0~7.0	1.0	1.0~3.0	A	*	*		*/A	*	*
64 	4.0	3.0~7.0	1.0	1.0~3.0	A	*	*		*/A	*	*
65 	4.0	3.0~7.0	1.0	1.0~3.0	A	*	*		*/A	*	*
66 	6.0	3.0~7.0	1.0	1.0~3.0	A	*	*		*/A	*	*
67 	6.0	3.0~7.0	1.0	1.0~3.0	A	*	*		*/A	*	*
68 	6.0	3.0~7.0	1.0	1.0~3.0	A	*	*		*/A	*	*
69 	6.0	3.0~7.0	1.5	1.0~3.0	A	*	*		*/A	*	*
70 	6.0	3.0~7.0	1.0	1.0~3.0	A	*	*		*/A	*	*
71 	6.0	3.0~7.0	1.0	1.0~3.0	A	*	*		*/A	*	*
72 	6.0	3.0~7.0	1.0	1.0~3.0	A	*	*		*/A	*	*
73 	6.0	5.0~7.0	1.0	1.0~3.0	A	*	*		*/A	*	*
74 	6.0	3.0~7.0	1.5	1.0~3.0	A	*	*		*/A	*	*
75 	6.0	2.5~7.0	1.5	1.0~3.0	A	*	*		*/A	*	*
76 	4.5	2.5~7.0	2.0	1.0~3.0	A	*	*		*/A	*	*
77 	5.0	2.5~7.0	2.0	1.0~3.0	A	*	*		*/A	*	*
78 	5.0	2.5~7.0	2.0	1.0~3.0	A	*	*		*/A	*	*
79 	5.0	2.5~7.0	2.0	1.0~3.0	A	*	*		*/A	*	*
80 	5.0	2.5~7.0	2.0	1.0~3.0	A	*	*		*/A	*	*
81 	5.0	2.5~7.0	2.0	1.0~3.0	A	*	*		*/A	*	*
82 	4.0	2.5~7.0	2.0	1.0~3.0	A	*	*		*/A	*	*
83 	5.0	2.5~7.0	2.0	1.0~3.0	A	*	*		*/A	*	*
84 	5.0	4.0~7.0	2.5	1.5~3.0	A	*	*		*/A	*	*
85 	5.0	3.5~7.0	2.0	1.5~3.0	A	*	*		*/A	*	*
86 	5.0	2.5~7.0	2.5	1.0~3.0	A(T)	*	*		*/A	*	*
87 	5.0	4.0~7.0	1.5	1.5~3.0	A	*	*		*/A	*	*
88 	5.0	4.0~7.0	2.0	1.5~3.0	A(T)	*	*		*/A	*	*
89 	5.0	2.5~7.0	1.5	1.0~3.0	A(T)	*	*		*/A	*	*
90 	5.5	2.5~7.0	1.5	1.0~3.0	A	*	*		*/A	*	*
91 	4.5	3.5~7.0	2.0	1.5~3.0	A	*	*		*/A	*	*
92 	5.0	4.5~7.0	1.0	1.0~3.0	A	*	*		*/A	*	*
93 	5.0	3.0~7.0	2.0	2.0~3.0	A	*	*		*/A	*	*
94 	5.0	4.0~7.0	1.5	1.0~3.0	A	*	*		*/A	*	*
95 	5.0	2.5~7.0	2.5	1.0~3.0	A	*	*		*/A	*	*
96 	5.0	2.5~7.0	2.5	1.5~3.0	A	*	*		*/A	*	*
97 	4.5	3.5~7.0	1.0	1.0~3.0	A	*	*		*/A	*	*
98 	7.0	3.0~7.0	2.0	1.0~3.0	A	*	*		*/A	*	*
99 	7.0	4.0~7.0	2.5	1.5~3.0	A	*	*		*/A	*	*

*: Adjustments can be made.



25 YEAR LIMITED WARRANTY

EURO-PRO Operating LLC warrants the sewing machine head and any of its parts other than those covered by the 2-year warranty below or those subject to normal wear and tear for a period of 25 years from date of the original purchase, to be free of defective parts due to imperfections in the workmanship and materials, subject to the following conditions, exclusions and exceptions.

The electrical equipment (motor, foot control, light, etc.) are warranted free from defects in material and workmanship for a period of two years from the date of original purchase.

Non-durable parts including, without limitation, needles, belts, bobbins, bulbs, bobbin cases, shuttles, springs, and parts which normally require replacement are specifically excluded from this warranty.

This warranty is void if: (a) This product has been cleaned, serviced, modified or tampered with by anyone other than an authorized service representative of **EURO-PRO**; (b) The serial number has been modified, defaced or removed from this sewing machine; (c) This product has been abused or damaged; (d) Non **EURO-PRO** branded parts, supplies, power supplies or other accessories have been used with this product.

This warranty is in effect provided the sewing machine is used only for normal household use by the original purchaser when new, and is given reasonable good care and proper maintenance in accordance with the accompanying instruction book. The manufacturer is not held responsible for damage, normal wear, accident, abuse, neglect, negligence or if the machine has been repaired by unqualified personnel.

This warranty is extended to the original purchaser of the unit and excludes all other legal and/or conventional warranties. The responsibility of **EURO-PRO Operating LLC** if any, is limited to the specific obligations expressly assumed by it under the terms of the limited warranty. **In no event is EURO-PRO Operating LLC** liable for any indirect, incidental or consequential damages of any nature whatsoever. Some provinces do not permit the exclusion or limitation of incidental or consequential damages, so the above may not apply to you.

This warranty gives you specific legal rights, and you may also have other rights which vary from province to province.

EURO-PRO Operating LLC will, at its option, repair or replace this sewing machine free of charge if it fails to operate according to specifications due to factory defects in materials or workmanship within one year from date of purchase. For 25 years from date of purchase, **EURO-PRO Operating LLC** will repair or replace defective sewing machine head parts; owner pays for labor charges. The sewing machine must be shipped freight and insurance prepaid to:

EURO-PRO Operating LLC, 4400 Bois Franc, St. Laurent, QC H4S 1A7 Tel.: 1 (800) 361-4639

A copy of your sales receipt and a check or money order made out to **EURO-PRO Operating LLC** in the amount of \$19.95 for handling and return packing/shipping charges must be included.*

***Important: Carefully pack item to avoid damage in shipping. We recommend you insure the package (as damage in shipping is not covered by your warranty). Be sure to include a copy of your sales receipt and attach a tag to the machine with your name, address and telephone number. Please include a check or money order made out to EURO-PRO Operating LLC in the amount of \$19.95 to cover return shipping and handling.**



OWNERSHIP REGISTRATION CARD

Please fill out and mail the product registration card within ten (10) days of purchase. The registration will enable us to contact you in the unlikely event of a product safety notification. By returning this card you acknowledge to have read and understood the instructions for use, and warnings set forth in the accompanying instructions.

RETURN TO: EURO-PRO Operating LLC, 4400 Bois Franc, St. Laurent, QC H4S 1A7 Tel.: 1 (800) 361-4639

Appliance model

Date purchased

Name of store

Owner's name

E-mail address

Address

City

Province

Postal Code

Would you like to receive information on updates, new products, etc. from EURO-PRO?	
<input type="checkbox"/> Yes	<input type="checkbox"/> No (fill one)

Free Manuals Download Website

<http://myh66.com>

<http://usermanuals.us>

<http://www.somanuals.com>

<http://www.4manuals.cc>

<http://www.manual-lib.com>

<http://www.404manual.com>

<http://www.luxmanual.com>

<http://aubethermostatmanual.com>

Golf course search by state

<http://golfingnear.com>

Email search by domain

<http://emailbydomain.com>

Auto manuals search

<http://auto.somanuals.com>

TV manuals search

<http://tv.somanuals.com>