

EURO-PRO

Canister Vacuum

OWNER'S MANUAL
Models CV520HB/HR/HY
120V., 60Hz., 10 Amps



EURO-PRO Operating LLC
94 Main Mill Street, Door 16
Plattsburgh, NY 12901
Tel.: 1 (800) 798-7398

ONE (1) YEAR LIMITED WARRANTY

EURO-PRO Operating LLC warrants this product to be free from defects in material and workmanship for a period of one (1) year from the date of the original purchase. This warranty applies only to normal domestic household use. Should your appliance fail to operate properly while in use under normal household conditions within the one (1) year warranty period, return the complete appliance and accessories, freight prepaid to **EURO-PRO Operating LLC** at the address given below.

In US: **EURO-PRO Operating LLC**, 94 Main Mill Street, Door 16, Plattsburgh, N.Y. 12901
In Canada: **EURO-PRO Operating LLC**, 4400 Bois Franc, St. Laurent, Quebec H4S 1A7

If the appliance is found by **EURO-PRO Operating LLC** to be defective in material or workmanship, **EURO-PRO Operating LLC** will repair or replace it free of charge. Proof of purchase date and \$ 15.95 to cover the cost of return shipping and handling must be included. * Non-durable parts including, without limitation, filters, dust bags and electrical parts which normally require replacement are specifically excluded from warranty.

The liability of **EURO-PRO Operating LLC** is limited solely to the cost of the repair or replacement of the unit at our option. This warranty does not cover normal wear of parts and does not apply to any unit that has been tampered with or used for commercial purposes. This limited warranty does not cover damage caused by misuse, abuse, negligent handling or damage due to faulty packaging or mishandling in transit. This warranty does not cover damage or defects caused by or resulting from damages from shipping or repairs, service or alterations to the product or any of its parts, which have been performed by a repair person not authorized by **EURO-PRO Operating LLC**.

This warranty is extended to the original purchaser of the unit and excludes all other legal and/or conventional warranties. The responsibility of **EURO-PRO Operating LLC** if any, is limited to the specific obligations expressly assumed by it under the terms of the limited warranty. **In no event is EURO-PRO Operating LLC** liable for incidental or consequential damages of any nature whatsoever. Some states do not permit the exclusion or limitation of incidental or consequential damages, so the above may not apply to you.

This warranty gives you specific legal rights, and you may also have other rights which vary from state to state.

***Important: Carefully pack item to avoid damage in shipping. Be sure to include proof of purchase date and to attach tag to item before packing with your name, complete address and phone number with a note giving purchase information, model number and what you believe is the problem with item. We recommend you insure the package (as damage in shipping is not covered by your warranty). Mark the outside of your package "ATTENTION CUSTOMER SERVICE". We are constantly striving to improve our products, therefore the specifications contained herein are subject to change without notice.**



OWNERSHIP REGISTRATION CARD

Please fill out and mail the product registration card within ten (10) days of purchase. The registration will enable us to contact you in the unlikely event of a product safety notification. By returning this card you acknowledge to have read and understood the instructions for use, and warnings set forth in the accompanying instructions.

RETURN TO **EURO-PRO Operating LLC**, 94 Main Mill Street, Door 16, Plattsburgh, NY 12901

Models CV520HB/HR/HY

Appliance model _____

Date purchased _____ Name of store _____

Owner's name _____

Address _____ City _____ State _____ Zip Code _____

IMPORTANT SAFETY INSTRUCTIONS

When using your **Canister Vacuum**, basic safety precautions should always be observed, including the following:

- WARNING:** To reduce the risk of fire, electrical shock, or injury:
1. **Do not** leave vacuum cleaner unattended when it is plugged in. Unplug from outlet when not in use.
 2. To reduce the risk of electric shock – **do not** use outdoors or on wet surfaces. **Do not** handle plug or vacuum cleaner with wet hands.
 3. **Do not** allow children to use as a toy. Close attention is necessary when used by or near children.
 4. Use only as described in this manual. Use only manufacturer's recommended attachments.
 5. **Do not** use with damaged cord or plug. **Do not** use vacuum cleaner if it has been dropped, damaged, left outdoors, or dropped into water. Return appliance to **EURO-PRO Operating LLC** for examination, repair or adjustment.
 6. **Do not** pull or carry by cord. **Do not** use cord as a handle, close a door on cord, or pull cord around sharp edges or corners. **Do not** run appliance over cord. Keep cord away from heated surfaces.
 7. **Do not** unplug by pulling on cord. To unplug, grasp the plug, not the cord.
 8. Keep hair, loose clothing, fingers, and all parts of body away from openings and moving parts.
 9. **Do not** pick up hot coals, cigarette butts, matches or any hot, smoking, or burning objects.
 10. **Do not** pick up hard or sharp objects such as glass, nails, screws, coins, etc.
 11. **Do not** use without paper bag or filters in place.
 12. Turn off all controls before plugging or unplugging vacuum cleaner.
 13. Use extra care when vacuuming on stairs.
 14. **Do not** pick up flammable or combustible materials (lighter fluid, gasoline, kerosene, etc.) or use in the presence of explosive liquids or vapor.
 15. **Do not** pick up toxic material (chlorine bleach, ammonia, drain cleaner, etc.).
 16. **Do not** use in an enclosed space filled with vapors given off by oil based paints, paint thinner, moth proofing substances, flammable dust, or other explosive or toxic vapors.
 17. Always unplug this appliance before connecting or disconnecting vacuum hose. Always hold the plug when rewinding the power cord. Do not allow plug to whip when rewinding.
 18. Use only on dry, indoor surfaces.
 19. **Do not** use for any purpose other than described in this user's guide.
 20. Use **only** extension cords UL or cUL-rated at 15 amperes. Extension cords rated for less amperage may overheat. Care should be taken to arrange the cord so that the cord cannot be pulled or tripped over.
 21. **Do not** put any objects into openings. **Do not** use with any opening blocked. Keep free of dust, lint, hair and anything else that may reduce air flow.
 22. Store your appliance indoors in a cool, dry area.
 23. Keep your work area well lit.
 24. **Do not** immerse the vacuum into water or other liquids.
 25. Keep end of hose, wands and other openings away from your face and body.

SAVE THESE INSTRUCTIONS

For Household Use Only



WARNING: To reduce the risk of electric shock, this appliance has a polarized plug (one blade is wider than the other). This plug will fit in a polarized outlet only one way. If the plug does not fit fully in the outlet, reverse the plug. If it still does not fit, contact a qualified electrician to install the proper outlet. Do not modify the plug in any way.

GETTING TO KNOW YOUR CANISTER VACUUM

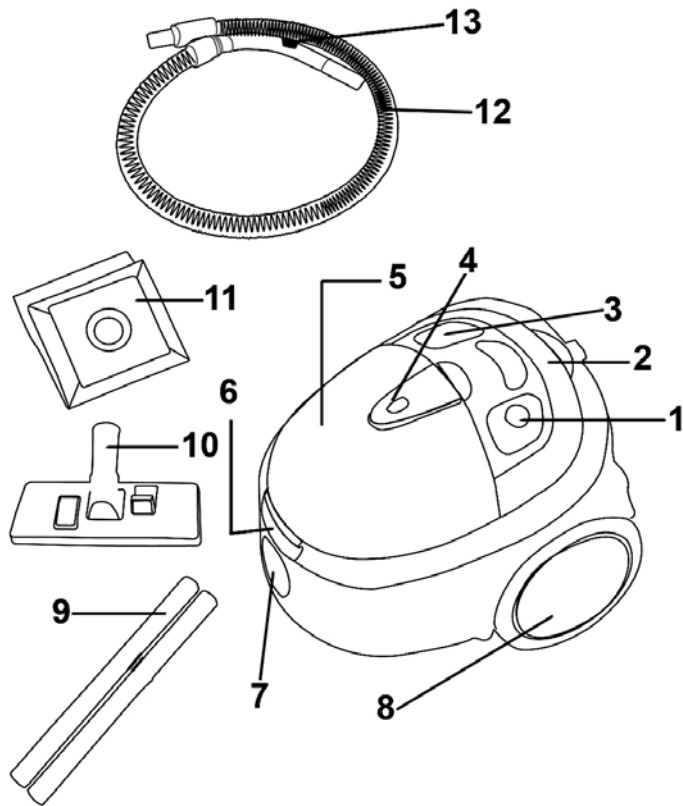

1. On/Off Button
2. Handle
3. Cord Rewind Button
4. Full Bag Indicator
5. Cover
6. Cover Locking Tab
7. Air Intake Duct

8. Easy Glide Rear Wheel
9. Extension Tubes (x2)
10. Carpet / Floor Brush
11. Dust Bags (x2)
12. Flexible Hose
13. Manual Suction Control

Technical Specifications

Voltage: 120V., 60Hz.
Power: 10 Amps

Illustrations may differ from actual product.

TROUBLE SHOOTING GUIDE

TROUBLESHOOTING GUIDE		
PROBLEM	POSSIBLE REASON	POSSIBLE SOLUTION
Motor runs but no suction	<ol style="list-style-type: none"> 1. Hose, wand or inlet is blocked. 2. Check bag full indicator. 3. Hose clamp not assembled to hose inlet properly. 	<ol style="list-style-type: none"> 1. Check for blockage - remove it. 2. If dust bag is full, replace dust bag or look for blockages in system or vacuum. 3. Insert hose clamp into hose inlet until "snap" locks for proper assembly.
Cord does not rewind	<ol style="list-style-type: none"> 1. Cord twisted. 2. Cord pulled out too far - beyond "RED" mark. 	<ol style="list-style-type: none"> 1. Pull cord out, straighten and rewind again. 2. Holding the plug, press the rewind button and try to rewind again.
Cleaner won't run	<ol style="list-style-type: none"> 1. Not firmly plugged in. 2. Blown fuse/tripped breaker. 3. Motor thermostat may have tripped. 	<ol style="list-style-type: none"> 1. Plug unit in firmly. 2. Replace fuse/reset breaker. 3. Allow unit to cool down before trying to switch "ON" again.

ORDERING REPLACEMENT FILTERS & BAGS

TO ORDER REPLACEMENT FILTERS & BAGS OR FOR TECHNICAL SUPPORT FOR MODEL CV520HB/HR/HY

Call: 1 (800) 798-7398

Monday to Friday 8:30 A.M. - 5:00 P.M. Eastern Standard Time

IMPORTANT: DO NOT ATTEMPT TO WASH or REUSE DUST BAGS.
Always replace with new dust bag to keep your unit in maximum working condition.

Please Note:

The Pre-Motor and Post-Motor Filter are washable. It should however be replaced every Three (3) to six (6) months, depending on usage, to ensure peak performance of your vacuum. Make sure that the Pre-Motor and Post-Motor Filters are **completely** air-dried for 24 hours before inserting back in the vacuum.

OPERATING INSTRUCTIONS

Replacing the Filters

Warning: To reduce the risk of electric shock, the power cord must be disconnected before changing the bag or performing maintenance/ troubleshooting.

Changing & Cleaning the Pre-Motor Filter

Your vacuum is equipped with a filtration system to reduce dust and pollen in your home as you clean. The pre-motor filter is located inside the vacuum cleaner body behind the dust bag. Check when changing the dust bag and replace when dirty.

This is a rinse-able filter but should be replaced every three (3) to six (6) months, depending on usage. Never operate the vacuum without **ALL** the filters in place

1. Push the Power On/Off button to the "Off" position and disconnect the power cord from the wall outlet.
2. To remove, open the dust bag compartment cover and remove the pre-motor filter out of the vacuum.
3. Rinse in lukewarm water and let it air dry completely for 24 hours. Do not use a washing machine to rinse the filter. Do not use a hair dryer to dry it. **Air dry only.** When the pre-motor filter is completely dry, insert the filter into the vacuum. (Fig. 11)



Fig. 11

Changing & Cleaning the Post Motor Filter

The post motor filter should be replaced every three (3) to six (6) months depending on usage. Never operate the vacuum without **ALL** the filters in place.

1. Push the Power On/Off button to the "Off" position and disconnect the power cord from the wall outlet.

2. The post motor filter is located at the rear of the unit.
3. Push down on the tab of the post motor filter assembly and pull the assembly out. (Fig. 12)
4. Remove the post-motor from the filter assembly. (Fig. 13)
5. Rinse in lukewarm water and let it air dry completely for 24 hours. Do not use a washing machine to rinse the filter. Do not use a hair dryer to dry it. **Air dry only.** When the post-motor filter is completely dry, insert it in the filter into the vacuum.



Fig. 12



Fig. 13

Motor Thermostat

Important: This unit is equipped with a motor protective thermostat. If for some reason the vacuum cleaner should overheat, the thermostat will automatically turn the unit off. Should this occur:

- Push the On/Off button once.
- Disconnect the plug from the power source.
- Check the source of overheating problem. (i.e. clogged hose or filter)
- If clogged hose or filter is found, unclog the hose and replace the filters.
- Wait at least 45 minutes before attempting to reuse the vacuum.
- After unit has cooled down for 45 minutes, plug in the cleaner and push the On/Off button. The vacuum should start again.
- If the vacuum still does not start, contact customer service at 1 (800) 798-7398.

PRECAUTIONARY MEASURES

Important: If the suction opening of the unit, the hose or the extension tubes are **BLOCKED**, switch off the vacuum cleaner and remove the blocking substance before you start the unit again.

1. Do not operate the vacuum cleaner too close to heaters or radiators.

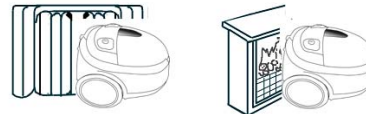

2. Before inserting the power plug into the wall outlet, make sure that your hands are dry.

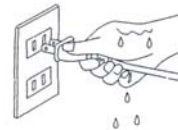

3. Before you start vacuuming, make sure to remove large or sharp objects that might damage the vacuum.



4. When pulling out the power plug from the wall outlet, pull the plug not the power cord.

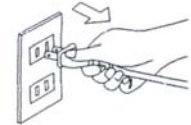

5. Do not pick up anything that is burning or smoking such as cigarettes, matches or hot ashes.



6. Do not use without all filters and dust bag in place.

Note: This vacuum cleaner is equipped with a plug and power cord that retract automatically. If the cord or plug gets damaged, it must be replaced by a qualified technician.

Warning: Hold the plug when rewinding the cord. Do not allow the cord to whip when rewinding.

OPERATING INSTRUCTIONS

Assembling Your Vacuum Cleaner

Note: Always remove the power plug from the wall outlet before assembling or removing accessories.

Attaching the Flexible Hose into the Vacuum

- To connect the flexible hose into the air intake duct, align the arrow on the hose with the arrow on the unit and push in and turn 180° clockwise to lock the hose in place. (Fig 1)
- To remove, reverse process.



Fitting the Curved Wand to the Extension Tubes

- Push the extension tube into the curved wand / hose extension, as shown in the illustration below. Make sure that the extension tube is secure. (Fig. 2) Attach the second extension tube to the first.

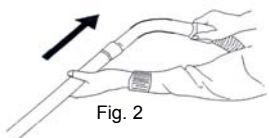

Fitting the Carpet to Floor Brush to the Extension Tubes

- Push the extension tube into the carpet / floor brush as show in Fig. 3

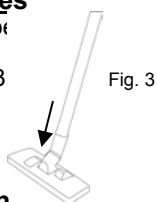

Carpet to Floor Brush

- The carpet to floor brush is equipped with an easy toggle switch to convert from carpet to bare floor.
- To set for carpet push down the toggle with the carpet symbol. (Fig. 4)
- To set for bare floors, push down the toggle with the floor symbol.

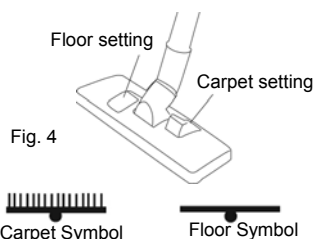

Note: When one switch is up the other will be down.

Power Cord

Your vacuum cleaner includes a power cord which is automatically retractable. To extend your power cord, pull from the rear and extend to desired length up to the yellow mark on the power cord. When cleaning is finished, first turn the unit off and disconnect from the electrical outlet. Then press on the cord rewind button to retract the power cord. If the cord does not fully retract, pull it out again and then press on the cord rewind button again. (Fig. 5)



Warning: Hold the plug when rewinding the cord. Do **NOT** allow cord to whip when rewinding.

NOTE: Before using the appliance, unwind a sufficient length of cable and insert the plug into the wall socket. A yellow mark on the power cord shows the ideal cable length. Don't pull the power cord beyond the red mark.

Dust Bag Full Indicator

The red dust bag full indicator may turn on while you are cleaning to indicate that the dust bag is full and requires replacement or if there is a blockage in the system or the vacuum.

Note: You can test the dust bag full indicator by placing your hand over the end of the flexible hose when the vacuum is running. The dust bag full indicator should turn red.

Using your Vacuum

Note: Once all attachments are in place, unwind a sufficient length of the power cord and insert the plug into the wall outlet. A yellow mark on the power cord shows the ideal cable length. Don't pull the power cord beyond the red mark.

1. Insert the power plug into the wall outlet.
2. Press the Power On/Off button located on the unit to turn the vacuum cleaner "On". (Fig. 6)
3. To rewind the power cord, press the cord rewind button with one hand and hold the plug of the power cord with the other hand to ensure that it does not whip causing damage or injury. (Fig. 7)

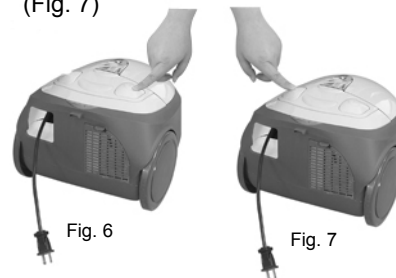

Manual Suction Control

On the handle of your flexible hose, there is the manual suction control. To adjust the suction, slide the manual suction up or down to vary the amount of suction. (Fig. 8) Increase suction when vacuuming carpets and reduce when dusting furniture or draperies.

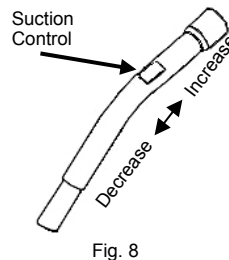

Inserting a New Dust Bag

Warning: To reduce the risk of electric shock, the power cord must be disconnected before changing the bag or performing maintenance/troubleshooting.

1. To open the dust bag compartment, lift up the cover locking tab. (Fig. 9)
2. Pull dust bag retaining clip forward. Remove the dust bag from the dust bag compartment by pulling up the cardboard section. Dispose of paper bags. **Never** reuse paper bags.

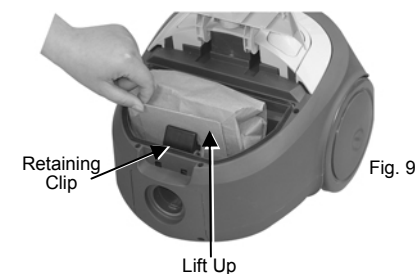

3. Insert a new dust bag back into the dust bag support guide inside the bottom of the dust bag compartment making sure that the dust bag rubber seal is aligned correctly against the air intake hole on the unit. (Fig. 9) When inserting the new dust bag, make sure that the arrow on the bag is pointing down. (Fig. 10)
4. Release the dust bag retaining clip, ensuring that the dust bag is held in place.

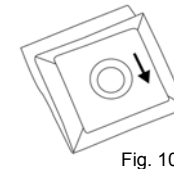

Caution: Make sure that the cardboard section of the dust bag is firmly in place inside the dust bag support.

Caution: The dust bag compartment will not close if the dust bag is not inserted properly into the unit. **Never** use the vacuum without a dust bag inserted into the unit. **NEVER** reuse the paper dust bags.

Free Manuals Download Website

<http://myh66.com>

<http://usermanuals.us>

<http://www.somanuals.com>

<http://www.4manuals.cc>

<http://www.manual-lib.com>

<http://www.404manual.com>

<http://www.luxmanual.com>

<http://aubethermostatmanual.com>

Golf course search by state

<http://golfingnear.com>

Email search by domain

<http://emailbydomain.com>

Auto manuals search

<http://auto.somanuals.com>

TV manuals search

<http://tv.somanuals.com>