

ONE (1) YEAR LIMITED WARRANTY

EURO-PRO Operating LLC warrants this product to be free from defects in material and workmanship for a period of one (1) year from the date of the original purchase. This warranty applies only to normal domestic household use.

Should your appliance fail to operate properly while in use under normal household conditions within the one (1) year warranty period, return the complete appliance and accessories, freight prepaid to **EURO-PRO Operating LLC** at the address given below. If the appliance is found to be defective in material or workmanship, **EURO-PRO Operating LLC** will repair or replace it free of charge. Proof of purchase date and \$19.95 to cover the cost of return shipping and handling must be included. *

In US: **EURO-PRO Operating LLC**, 94 Main Mill Street, Door 16, Plattsburgh, NY 12901

Non-durable parts including, without limitation, rotating brushes and electrical parts which normally require replacement are specifically excluded from warranty.

The liability of **EURO-PRO Operating LLC** is limited solely to the cost of the repair or replacement of the unit at our option. This warranty does not cover normal wear of parts and does not apply to any unit that has been tampered with or used for commercial purposes. This limited warranty does not cover damage caused by misuse, abuse, negligent handling or damage due to faulty packaging or mishandling in transit. This warranty does not cover damage or defects caused by or resulting from damages from shipping or repairs, service or alterations to the product or any of its parts, which have been performed by a repair person not authorized by **EURO-PRO Operating LLC**.

This warranty is extended to the original purchaser of the unit and excludes all other legal and/or conventional warranties. The responsibility of **EURO-PRO Operating LLC** if any, is limited to the specific obligations expressly assumed by it under the terms of the limited warranty. **In no event is EURO-PRO Operating LLC** liable for incidental or consequential damages of any nature whatsoever. Some states do not permit the exclusion or limitation of incidental or consequential damages, so the above may not apply to you.

This warranty gives you specific legal rights, and you may also have other rights which vary from state to state.

***Important: Carefully pack item to avoid damage in shipping. Be sure to include proof of purchase date and to attach tag to item before packing with your name, complete address and phone number with a note giving purchase information, model number and what you believe is the problem with item. We recommend you insure the package (as damage in shipping is not covered by your warranty). Mark the outside of your package "ATTENTION CUSTOMER SERVICE".**

We are constantly striving to improve our products, therefore the specifications contained herein are subject to change without notice.

Shark™ Pursuit™

Bagless Cyclonic Canister

OWNER'S MANUAL

Model EP724
120V., 60Hz., 10.3 Amps



For information or assistance:
EURO-PRO Operating LLC
94 Main Mill Street, Door 16
Plattsburgh, NY 12901
www.sharkvac.com

IMPORTANT SAFETY INSTRUCTIONS

When using your **Bagless Cyclonic Canister** vacuum, basic safety precautions should always be observed, including the following:

WARNING: To reduce the risk of fire, electrical shock, or injury:

1. Do not leave vacuum cleaner unattended when it is plugged in. Unplug from outlet when not in use.
2. To reduce the risk of electric shock – do not use outdoors or on wet surfaces. Do not handle plug or vacuum cleaner with wet hands.
3. Do not allow children to use as a toy. Close attention is necessary when used by or near children.
4. Use only as described in this manual. Use only manufacturer's recommended attachments.
5. Do not use with damaged cord or plug. Do not use vacuum cleaner if it has been dropped, damaged, left outdoors, or dropped into water. Return appliance to **EURO-PRO Operating LLC** for examination, repair or adjustment.
6. Do not pull or carry by cord. Do not use cord as a handle, close a door on cord, or pull cord around sharp edges or corners. Do not run appliance over cord. Keep cord away from heated surfaces.
7. Do not unplug by pulling on cord. To unplug, grasp the plug, not the cord.
8. Keep hair, loose clothing, fingers, and all parts of body away from openings and moving parts.
9. Do not pick up hot coals, cigarette butts, matches or any hot, smoking, or burning objects.
10. Do not pick up hard or sharp objects such as glass, nails, screws, coins, etc.
11. Do not use without filters in place.
12. Turn off all controls before plugging or unplugging vacuum cleaner.
13. Use extra care when vacuuming on stairs.
14. Do not pick up flammable or combustible materials (lighter fluid, gasoline, kerosene, etc.) or use in the presence of explosive liquids or vapor.
15. Do not pick up toxic material (chlorine bleach, ammonia, drain cleaner, etc.).
16. Do not use in an enclosed space filled with vapors given off by oil based paints, paint thinner, moth proofing substances, flammable dust, or other explosive or toxic vapors.
17. Always unplug this appliance before connecting or disconnecting vacuum hose. Always hold the plug when rewinding the power cord. Do not allow plug to whip when rewinding.
18. Use only on dry, indoor surfaces.
19. Do not use for any purpose other than described in this user's guide.
20. Use **only** extension cords UL or cUL-rated at 15 amperes. Extension cords rated for less amperage may overheat. Care should be taken to arrange the cord so that the cord cannot be pulled or tripped over.
21. **Do not** put any objects into openings. Do not use with any opening blocked. Keep free of dust, lint, hair and anything else that may reduce air flow.
22. Store your appliance indoors in a cool, dry area.
23. Keep your work area well lit.
24. **Do not** immerse the hand vacuum into water or other liquids.
25. Keep end of hose, wands and other openings away from your face and body.

SAVE THESE INSTRUCTIONS

For Household Use Only

WARNING: To reduce the risk of electric shock, this appliance has a polarized plug (one blade is wider than the other). This plug will fit in a polarized outlet only one way. If the plug does not fit fully in the outlet, reverse the plug. If it still does not fit, contact a qualified electrician to install the proper outlet. Do not modify the plug in any way.

Shark™ Pursuit™

Bagless Cyclonic Canister FOR REPLACEMENT FILTERS

for Model EP724

Style # XSH724 – HEPA Filter Only Style XSM724 – Filter Kit

Call: 1-866-98SHARK (1-866-987-4275)
Monday to Friday 8:30 A.M. - 5:00 P.M. Eastern Standard Time
or
visit our website: www.sharkvac.com

FOR TECHNICAL SUPPORT for Model EP724

In U.S.: 1 (800) 798-7398

Monday to Friday 8:30 A.M. - 5:00 P.M. Eastern Standard Time

Please Note:

The HEPA Dust Cup Filter may be washed. We recommend that this be done once a month or when suction appears reduced .

To wash your HEPA dust cup filter, hold filter cartridge by frame flange, flange side up and rinse under water. When finished, shake off excess water. Do **NOT** wash in dishwasher.

It is important that when you wash the HEPA dust cup filter, you allow it to dry **COMPLETELY** before using it again. We recommend 24 hours to air dry. **DO NOT DRY IN DRYER.** The HEPA Dust Cup Filter should be replaced every 3 months or sooner depending on amount of use.

IMPORTANT: The Pre-Motor Filter, Pre-Filter and Post Motor Filter should be replaced every 6 months or sooner if required.

All filters should be checked regularly for signs of damage, preferable after each cleaning task. The filters must be replaced immediately if they become damaged. Always disconnect the vacuum from the electrical outlet when checking the filters.

Important:

This vacuum cleaner is equipped with a motor protective thermostat. If for some reason your vacuum overheats, the thermostat will automatically turn the unit off. Should this occur, unplug the vacuum from the wall outlet and turn off the switch. Empty the dust cup, "TapClean" the dust cup filter and check for blockages in hose and suction inlet. Allow the unit to cool for a minimum of 45 minimum prior to restarting the unit. To restart, re-plug the vacuum into the wall socket and turn the switch back on.

PROBLEM SOLVING

This appliance was inspected thoroughly and was in good operating condition when it was shipped from the factory. If a minor problem occurs, it usually can be solved quite easily when the cause is found. Therefore, this checklist is provided for your convenience.

PROBLEM	POSSIBLE CAUSE	POSSIBLE
Cleaner Won't Run	<ol style="list-style-type: none"> 1. Not firmly plugged in. 2. No electricity in wall outlet. 3. On/Off switch not turned on. 4. Thermal protector tripped. 5. Blown fuse/tripped breaker. 	<ol style="list-style-type: none"> 1. Plug in firmly, push on/off switch to on. 2. Check fuse or breaker. 3. Push on/off switch to on. 4. Reset thermal protector. 5. Reset circuit breaker or replace fuse.
Cleaner Won't Pick Up	<ol style="list-style-type: none"> 1. Full or clogged dust cup. 2. Clogged nozzle or dust cup port. 3. Clogged hose. 4. Hole in hose. 5. Hose not inserted fully. 6. Motor protection system activated. 7. Dirty filters. 	<ol style="list-style-type: none"> 1. Clean dust cup. 2. Remove obstruction. 3. Remove obstruction. 4. Replace hose. 5. Push hose in securely. 6. Reset thermal protector. 7. Clean / change filters.
Air Flow Restricted With Attachment Use Sound Changes	<ol style="list-style-type: none"> 1. Attachment use restricts airflow. 2. New carpet trimmings clogging air passage. 	<ol style="list-style-type: none"> 1. Check attachment. 2. Remove obstruction.

GETTING TO KNOW YOUR BAGLESS CYCLONIC CANISTER

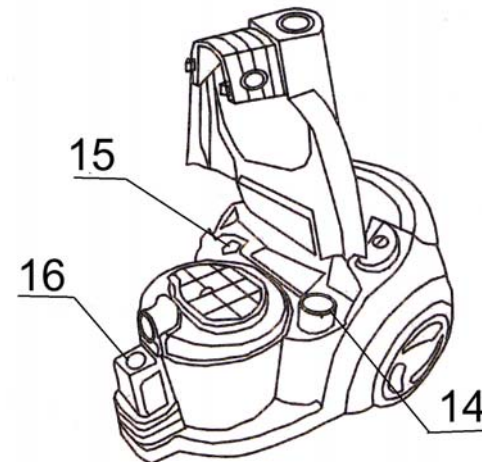
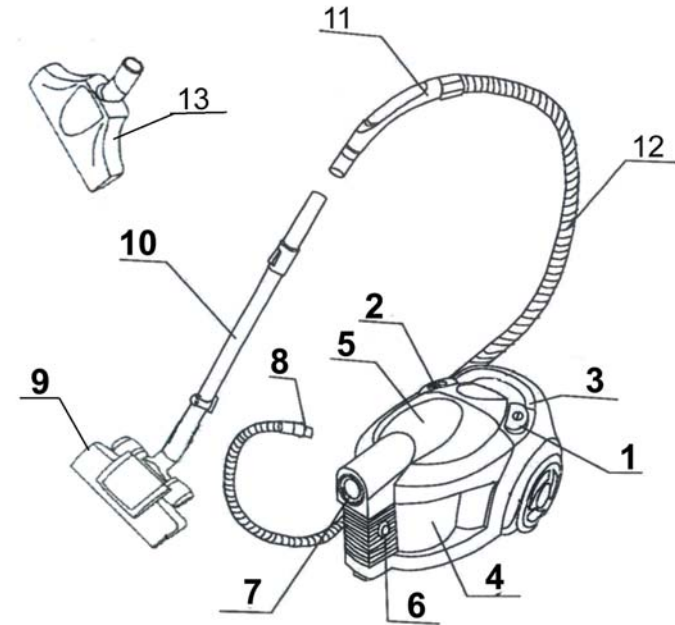

1. On/Off Button
2. Cord Rewind Button
3. Carrying Handle
4. Dust Cup
5. Dust Cup Cover
6. Dust Cup Cover Release
7. Hose Connector Inlet
8. Hose Connector
9. Floor to Carpet Brush
10. Chrome Telescopic Tube
11. Curved Wand/Hose Extension
12. Flexible Hose
13. Air Driven Turbo Brush
14. Crevice Tool
15. Upholstery Brush
16. Trap Door Release Button

Technical Specifications

Main Unit: Voltage: 120V., 60Hz.
Power: 10.3 Amps

PRECAUTIONARY MEASURES

Important: If the suction opening of the unit, the hose or the chrome telescopic tube are **BLOCKED**, switch off the vacuum cleaner and remove the blocking substance before you start the unit again.

1. Do not operate the vacuum cleaner too close to heaters or radiators.

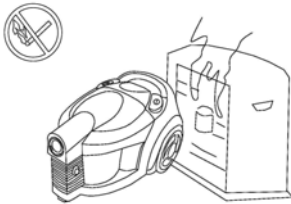

2. Before inserting the power plug into the wall outlet, make sure that your hands are dry.

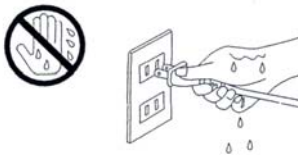

3. Before you start vacuuming, make sure to remove large or sharp objects that might damage the dust bag.

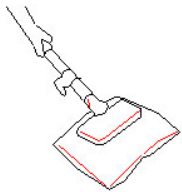

4. When pulling out the power plug from the wall outlet, pull the plug not the power cord.

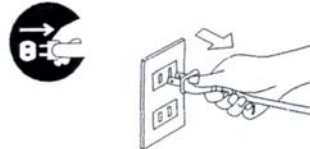

5. Do not pick up anything that is burning or smoking such as cigarettes, matches or hot ashes.

6. Do not use without all filters in place.

Note: This vacuum cleaner is equipped with a plug and power cord that retract automatically. If the cord or plug get damaged, it must be replaced by a qualified technician.

Warning: Hold the plug when rewinding the cord. Do not allow the cord to whip when rewinding.

OPERATING INSTRUCTIONS

Changing & Cleaning the Pre-Motor Filter

The pre-motor filter is located behind the dust cup. See illustration below.

This is a rinseable filter but should be replaced every six (6) months. Never operate the vacuum without ALL the filters in place.

- Push the Power On/Off button to the "Off" position and disconnect the power cord from the wall outlet.
- Open the dust cup cover.
- Remove the pre-motor filter and rinse in lukewarm water, let dry completely. Do not use a washing machine to rinse the filter. Do not use a hair dryer to dry it. Air dry only.
- When filter is completely dry, replace pre-motor filter back into the unit and close the dust cup cover.

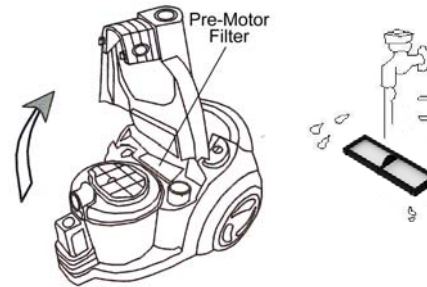

Changing & Cleaning the Post Motor Filter

The post motor filter is a washable filter but should be replaced every six (6) months depending on usage. Never operate the vacuum without ALL the filters in place.

- Push the Power On/Off button to the "Off" position and disconnect the power cord from the wall outlet.
- The post motor filter is located on the rear of the vacuum. Remove the filter from the filter grill.
- Rinse in lukewarm water, let dry completely. Do not use a washing machine to rinse the filter. Do not use a hair dryer to dry it. Air dry only.
- When filter is completely dry, replace post motor filter back into the unit and replace the filter cover.

Please Note: The HEPA Dust Cup Filter is washable. It should, however, be replaced every six (6) months to ensure peak performance of your vacuum.

The Post Motor Filter, Pre-Motor Filter and Pre-Filter are washable. They should however be replaced every six (6) months to ensure peak performance of your vacuum.

Important: Make sure that **ALL** filters are completely dry before re-installing back in the hand vacuum.

Important: All filters should be checked regularly for signs of damage, preferably after each cleaning task. The filters must be replaced immediately if they become damaged. Always disconnect the vacuum from the electrical outlet when checking the filters.

Cleaning Air Driven Turbo Brush

1. On the base of the turbo brush there is an access door for the turbine. To open for cleaning, push latch toward door and lift door off.
2. Inspect turbine wheel and air passage for debris and/or blockage. Remove debris if present.
3. Inspect the rotating brush for built-up hair or string. If present, remove by carefully cutting with scissors. Avoid damaging or cutting bristles.
4. Once clean, snap the turbine access door back in place. The turbo brush will not function without the access door in place.

OPERATING INSTRUCTIONS

9. Vigorously "TapClean" the HEPA Dust Cup Filter on a hard surface until no more dust is observed falling out from between the pleats of the filter. See illustration at right.



PLEASE NOTE: The white pleated filter material in the HEPA Dust Cup Filter will discolor over time -This is NORMAL and will NOT affect the performance of the filter. If the HEPA Dust Cup Filter is properly

"TapCleaned" after each use and suction does not return to 100%, then we suggest that the HEPA filter be "TapCleaned" vigorously until no more dust can be removed, then rinsed under the faucet and allowed to dry for 24 hours before refitting into the vacuum. (Fig. A) **This should be done once a month or when suction appears to be reduced.**

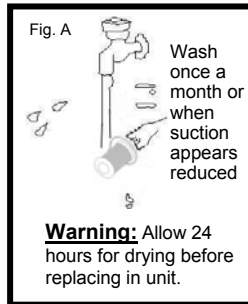

Important: The suction hole must be open, free of any obstructions at all times. Otherwise, the motor will overheat and could become damaged.

10. Reassemble the debris screen to the HEPA filter cartridge and replace into dust cup (container). Ensure that the filter assembly is completely seated inside the dust cup (container).

Important: Do NOT use the HEPA filter cartridge without the debris screen in place.

11. Insert the Rinseable "TapClean" HEPA dust cup filter back into the dust cup.
12. Re-install dust cup into the vacuum. Close cover and re-attach hose.

IMPORTANT: Please note that there is a safety switch inside the vacuum where the dust cup is inserted to prevent the unit from being run without a dust cup filter in place. If the dust cup filter has not engaged this safety switch, the vacuum will NOT operate. Therefore, ensure that the dust cup filter is inserted firmly into the vacuum when assembling.

Changing & Cleaning the Pre-Filter

The pre-filter is located on the top of the Rinseable "TapClean" HEPA filter. See illustration below.

This is a rinseable filter but should be replaced every six (6) months. Never operate the vacuum without ALL the filters in place.

- Push the Power On/Off button to the "Off" position and disconnect the power cord from the wall outlet.
- Open the dust cup cover and remove the dust cup being careful not to press on the trap door release button.
- Remove the HEPA filter and hold the tab that is on the top of the filter and pull until the filter cover snaps off.
- Rinse pre-filter in lukewarm water, let dry completely. Do not use a washing machine to rinse the filter. Do not use a hair dryer to dry it. Air dry only.
- Replace only when the pre-filter is completely dry, replace into HEPA filter and snap the cover back in place.



OPERATING INSTRUCTIONS

Assembling Your Vacuum Cleaner

Note: Always remove the power plug from the wall outlet before assembling or removing accessories.

1. Attaching the Flexible Hose into the Vacuum

Connect the flexible hose into the hose connector inlet. Push in until you hear a "click", indicating it is in its locked position.

2. Fitting the Chrome Telescopic Tube to the Curved Wand / Hose Extension

Push the chrome telescopic tube into the curved wand / hose extension, as shown in the illustration below.

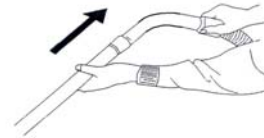

3. Extending the Chrome Telescopic Tube

Push forward on the plastic button and pull the inner chrome tube outward.

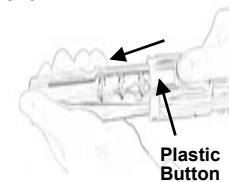

4. Fitting the Floor to Carpet Brush or the Air Driven Turbo Brush to the Telescopic Tube

Push the telescopic tube into the desired floor brush as show in the illustration below.

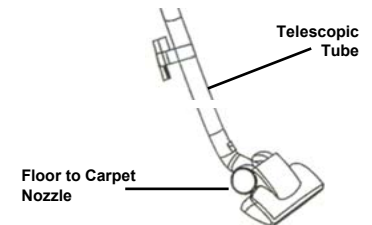

5. Air Driven Turbo Brush

The efficiency of your Air Driven Turbo Brush depends on the bristle brush rotating at high speed. Strong air suction is needed to accomplish this. In order to ensure that maximum air suction is maintained, please read the following instructions:

- Empty the Dust Cup frequently during use.
- Always "TapClean" the HEPA dust cup filter each time the dust cup is emptied.
- Ensure that the rotating bristle brush is kept free of hair and string.
- Inspect the turbine regularly to ensure that the air passage is free of dirt and debris. See cleaning instructions on page 8.



OPERATING INSTRUCTIONS

Crevice Tool and Dusting Brush

1. Crevice Tool with Brush

For radiators, crevices, corners, baseboards and between cushions.



2. Upholstery Brush

The dusting brush is used for the furniture



- To rewind the power cord, press the cord rewind button with one hand and hold the plug of the power cord with the other hand to ensure that it does not whip causing damage or injury.

Motor Thermostat

Important: This vacuum cleaner is equipped with a motor protective thermostat. If for some reason your vacuum overheats, the thermostat will automatically turn the unit off. Should this occur, unplug the vacuum from the wall outlet and turn off the switch. Empty the dust cup, "TapClean" the dust cup filter and check for blockages in hose and suction inlet. Allow the unit to cool for a minimum of 45 minutes prior to restarting the unit. To restart, re-plug the vacuum into the wall socket and turn the switch back on

Using your Vacuum

Note: Once all attachments are in place, unwind a sufficient length of cable and insert the plug into the wall outlet. A yellow mark on the power cord shows the ideal cable length. Don't pull the power cord beyond the red mark.

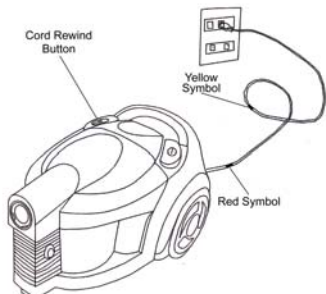

- Insert the power plug into the wall outlet.
- Press the Power On/Off button located on the unit to turn the vacuum cleaner "On".

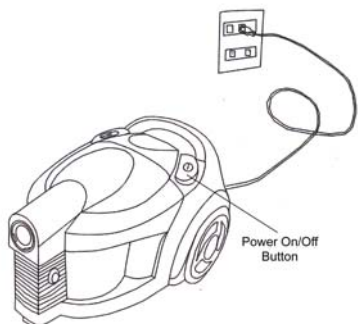

OPERATING INSTRUCTIONS

Removing & Cleaning the Rinseable "TapClean" HEPA Dust Cup Filter

Warning: Always unplug the unit from electrical outlet before removing the Dust Cup (container).

- Push the Power On/Off button to "Off" and disconnect the power cord from the wall outlet.
- Remove the flexible hose.
- Push the dust cup cover release button located on the front side of the unit (see illustration) and lift the cover up.
- Hold the dust cup by the handle and lift it up out of the vacuum
- Hold dust cup over a waste basket (garbage can), lift cover and then depress the trap door release button to open the dust cup. Dispose of the dust inside. (See illustrations below.)

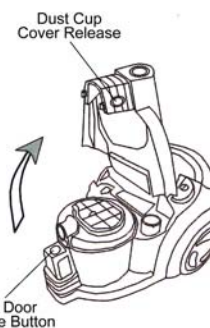

Note: If dust is tightly packed and difficult to remove, tap the side of the dust cup lightly against the side of the waste basket (garbage can).

Lift cover, then depress button to open trap door

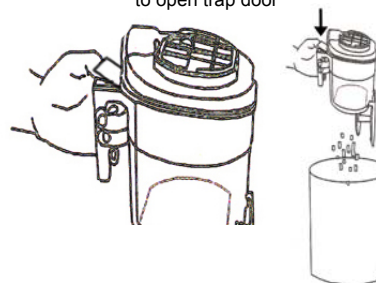

- To remove the Rinseable "TapClean" HEPA dust cup filter from the dust cup, hold the filter from the tab at the top of it and lift. See illustration at right.



- After you have removed the Rinseable "TapClean" HEPA dust cup filter from the dust cup, separate the debris screen from the HEPA filter cartridge by holding the top rim of the filter and twisting the debris screen counterclockwise to unlock the debris screen from the filter. Then lift the debris screen to remove.

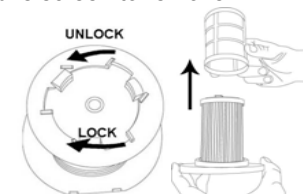

- Rinse the debris screen under the faucet until clean. Allow to air dry or dry with a clean dish towel. Do **NOT** wash in dishwasher.
- To replace the debris screen onto the filter, slip the debris screen over the filter and twist clockwise to lock in place.

Warning: After each Use - Always remove the Rinseable "TapClean" HEPA Filter from the Dust Cup, then vigorously "TapClean" HEPA Filter until no more dust can be removed.

Important: When "TapCleaning" the HEPA filter, hold the HEPA filter from the top rim and tap **ONLY** the bottom rim against the side of the waste container. **NEVER** tap directly on the pleated folds of the HEPA filter.

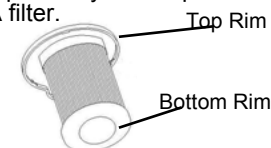

IMPORTANT, Please Note : The Rinseable "TapClean" HEPA Dust Cup Filter will stop most of the tiniest dust particles and airborne allergens from re-entering the air you breathe. In fact it stops 99.97% of all particles as small as 0.3 microns - many times smaller than a human hair!!! Because of this incredible filtration performance, the HEPA Dust Cup Filter will quickly accumulate dirt inside the white filter folds, many fine dust particles that are difficult to see but which will eventually block or reduce your suction power - if not cleaned properly. Clean the HEPA Filter as described in this section, then reconnect unit and proceed with vacuuming.)

Free Manuals Download Website

<http://myh66.com>

<http://usermanuals.us>

<http://www.somanuals.com>

<http://www.4manuals.cc>

<http://www.manual-lib.com>

<http://www.404manual.com>

<http://www.luxmanual.com>

<http://aubethermostatmanual.com>

Golf course search by state

<http://golfingnear.com>

Email search by domain

<http://emailbydomain.com>

Auto manuals search

<http://auto.somanuals.com>

TV manuals search

<http://tv.somanuals.com>