

**EURO-PRO**   
select

**Canister Vacuum**

**OWNER'S MANUAL**

**Model EP733H**

120V., 60Hz., 12 Amps



**EURO-PRO Operating LLC**  
94 Main Mill Street, Door 16  
Plattsburgh, NY 12901  
Tel.: 1 (800) 798-7398

**EURO-PRO** 

# IMPORTANT SAFETY INSTRUCTIONS

When using your **Canister Vacuum**, basic safety precautions should always be observed, including the following:

- WARNING:** To reduce the risk of fire, electrical shock, or injury:
1. Do not leave vacuum cleaner unattended when it is plugged in. Unplug from outlet when not in use.
  2. To reduce the risk of electric shock – do not use outdoors or on wet surfaces. Do not handle plug or vacuum cleaner with wet hands.
  3. Do not allow children to use as a toy. Close attention is necessary when used by or near children.
  4. Use only as described in this manual. Use only manufacturer's recommended attachments.
  5. Do not use with damaged cord or plug. Do not use vacuum cleaner if it has been dropped, damaged, left outdoors, or dropped into water. Return appliance to **EURO-PRO Operating LLC** for examination, repair or adjustment.
  6. Do not pull or carry by cord. Do not use cord as a handle, close a door on cord, or pull cord around sharp edges or corners. Do not run appliance over cord. Keep cord away from heated surfaces.
  7. Do not unplug by pulling on cord. To unplug, grasp the plug, not the cord.
  8. Keep hair, loose clothing, fingers, and all parts of body away from openings and moving parts.
  9. Do not pick up hot coals, cigarette butts, matches or any hot, smoking, or burning objects.
  10. Do not pick up hard or sharp objects such as glass, nails, screws, coins, etc.
  11. Do not use without paper bag or filters in place.
  12. Turn off all controls before plugging or unplugging vacuum cleaner.

13. Use extra care when vacuuming on stairs.
14. Do not pick up flammable or combustible materials (lighter fluid, gasoline, kerosene, etc.) or use in the presence of explosive liquids or vapor.
15. Do not pick up toxic material (chlorine bleach, ammonia, drain cleaner, etc.).
16. Do not use in an enclosed space filled with vapors given off by oil based paints, paint thinner, moth proofing substances, flammable dust, or other explosive or toxic vapors.
17. Always unplug this appliance before connecting or disconnecting vacuum hose. Always hold the plug when rewinding the power cord. Do not allow plug to whip when rewinding.
18. Use only on dry, indoor surfaces.
19. Do not use for any purpose other than described in this user's guide.
20. Use **only** extension cords UL or cUL-rated at 15 amperes. Extension cords rated for less amperage may overheat. Care should be taken to arrange the cord so that the cord cannot be pulled or tripped over.
21. **Do not** put any objects into openings. Do not use with any opening blocked. Keep free of dust, lint, hair and anything else that may reduce air flow.
22. Store your appliance indoors in a cool, dry area.
23. Keep your work area well lit.
24. **Do not** immerse the vacuum into water or other liquids.
25. Keep end of hose, wands and other openings away from your face and body.

## SAVE THESE INSTRUCTIONS For Household Use Only



**WARNING:** To reduce the risk of electric shock, this appliance has a polarized plug (one blade is wider than the other). This plug will fit in a polarized outlet only one way. If the plug does not fit fully in the outlet, reverse the plug. If it still does not fit, contact a qualified electrician to install the proper outlet. Do not modify the plug in any way.

Model EP733H



### ONE (1) YEAR LIMITED WARRANTY

**EURO-PRO Operating LLC** warrants this product to be free from defects in material and workmanship for a period of one (1) year from the date of the original purchase. This warranty applies only to normal domestic household use. Should your appliance fail to operate properly while in use under normal household conditions within the one (1) year warranty period, return the complete appliance and accessories, freight prepaid to **EURO-PRO Operating LLC** at the address given below.

In US: **EURO-PRO Operating LLC**, 94 Main Mill Street, Door 16, Plattsburgh, N.Y. 12901  
In Canada: **EURO-PRO Operating LLC**, 4400 Bois Franc, St. Laurent, Quebec H4S 1A7

If the appliance is found by **EURO-PRO Operating LLC** to be defective in material or workmanship, **EURO-PRO Operating LLC** will repair or replace it free of charge. Proof of purchase date and \$ 24.95 to cover the cost of return shipping and handling must be included. \* Non-durable parts including, without limitation, rotating brushes, filters, dust bags and electrical parts which normally require replacement are specifically excluded from warranty.

The liability of **EURO-PRO Operating LLC** is limited solely to the cost of the repair or replacement of the unit at our option. This warranty does not cover normal wear of parts and does not apply to any unit that has been tampered with or used for commercial purposes. This limited warranty does not cover damage caused by misuse, abuse, negligent handling or damage due to faulty packaging or mishandling in transit. This warranty does not cover damage or defects caused by or resulting from damages from shipping or repairs, service or alterations to the product or any of its parts, which have been performed by a repair person not authorized by **EURO-PRO Operating LLC**.

This warranty is extended to the original purchaser of the unit and excludes all other legal and/or conventional warranties. The responsibility of **EURO-PRO Operating LLC** if any, is limited to the specific obligations expressly assumed by it under the terms of the limited warranty. **In no event is EURO-PRO Operating LLC** liable for incidental or consequential damages of any nature whatsoever. Some states do not permit the exclusion or limitation of incidental or consequential damages, so the above may not apply to you. This warranty gives you specific legal rights, and you may also have other rights which vary from state to state.

**\*Important: Carefully pack item to avoid damage in shipping. Be sure to include proof of purchase date and to attach tag to item before packing with your name, complete address and phone number with a note giving purchase information, model number and what you believe is the problem with item. We recommend you insure the package (as damage in shipping is not covered by your warranty). Mark the outside of your package "ATTENTION CUSTOMER SERVICE". We are constantly striving to improve our products, therefore the specifications contained herein are subject to change without notice.**



### OWNERSHIP REGISTRATION CARD

Please fill out and mail the product registration card within ten (10) days of purchase. The registration will enable us to contact you in the unlikely event of a product safety notification. By returning this card you acknowledge to have read and understood the instructions for use, and warnings set forth in the accompanying instructions.

RETURN TO **EURO-PRO Operating LLC**:

U.S.: 94 Main Mill Street, Door 16, Plattsburgh, NY 12901

Model EP733H

Appliance model

Date purchased

Name of store

Owner's name

Address

City

State

Zip Code

## ORDERING REPLACEMENT FILTERS & BAGS

### TO ORDER REPLACEMENT FILTERS & BAGS OR FOR TECHNICAL SUPPORT

FOR MODEL EP733H

Call: 1 (800) 798-7398

Monday to Friday 8:30 A.M. - 5:00 P.M. Eastern Standard Time

**IMPORTANT: DO NOT ATTEMPT TO WASH or REUSE DUST BAGS.**  
Always replace with new dust bag to keep your unit in maximum working condition.

#### Please Note:

The Pre-Motor Filter is washable. It should however be replaced every six (6) months to ensure peak performance of your vacuum. Make sure that the Pre-Filter is **completely** air-dried for 24 hours before inserting back in the vacuum.

The HEPA-Type Post Motor filter is NOT washable. This must be replaced every six (6) months, depending on the amount of usage.

## GETTING TO KNOW YOUR CANISTER VACUUM

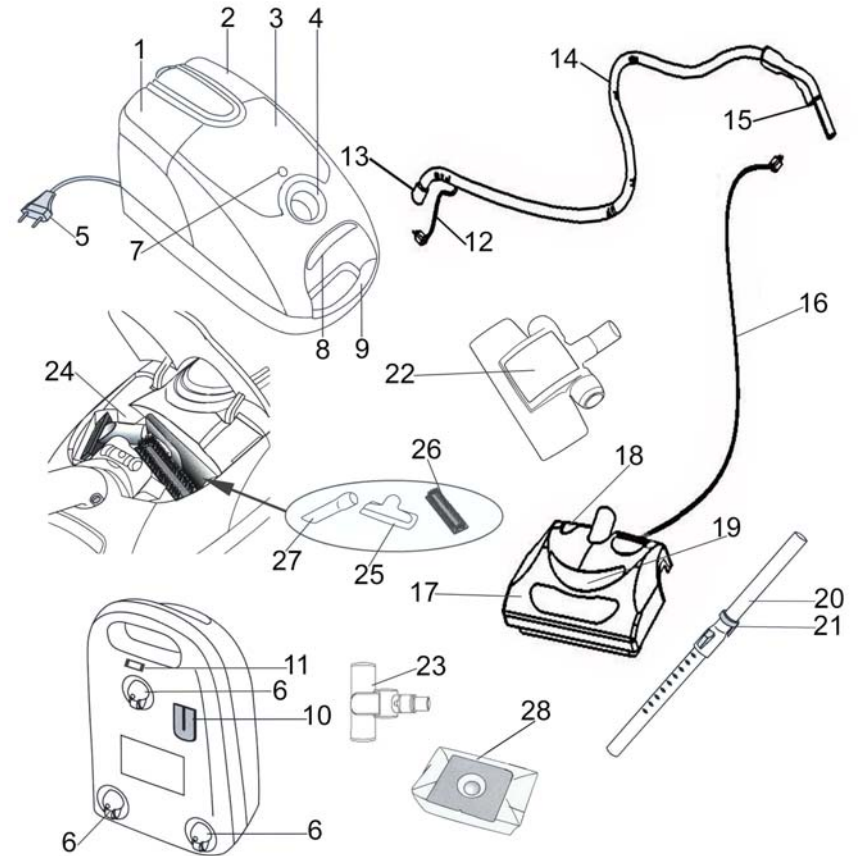

- |   |  |
|---|--|
| 1. Cord Rewind Button                     | 15. Receptacle For Power Nozzle Power Cord |
| 2. On/Off Button                          | 16. Power Nozzle Power Cord                |
| 3. Accessory Compartment Cover            | 17. Power Nozzle                           |
| 4. Flexible Hose Inlet                    | 18. Power Nozzle On/Off Button             |
| 5. Power Cord                             | 19. Head Light                             |
| 6. Castors                                | 20. Telescopic Tube                        |
| 7. Dust Bag Full Indicator                | 21. Parking Position Bracket               |
| 8. Dust Bag Compartment Release Button    | 22. Floor To Carpet Brush                  |
| 9. Carrying Handle                        | 23. Air Driven Turbo Brush                 |
| 10. Parking Position Support              | 24. Accessory Compartment                  |
| 11. Hose Connecting Power Cord Receptacle | 25. Upholstery Tool                        |
| 12. Hose Connecting Power Cord            | 26. Upholstery Brush                       |
| 13. Hose Connector                        | 27. Crevice Tool                           |
| 14. Flexible Hose                         | 28. Paper Bags (X9)                        |

#### **Technical Specifications**

Main Unit: Voltage: 120V., 60Hz.  
Power: 10.3 Amps

With Motorized Power Head: Voltage: 120V., 60 Hz.  
Power: 12 Amps

Illustrations may differ from actual product.

## PRECAUTIONARY MEASURES

**Important:** If the suction opening of the unit, the hose or the chrome telescopic tube are **BLOCKED**, switch off the vacuum cleaner and remove the blocking substance before you start the unit again.

1. Do not operate the vacuum cleaner too close to heaters or radiators.

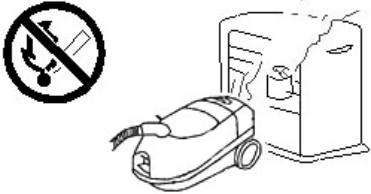

2. Before inserting the power plug into the wall outlet, make sure that your hands are dry.

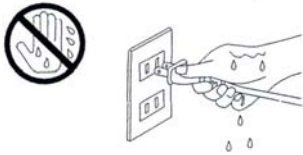

3. Before you start vacuuming, make sure to remove large or sharp objects that might damage the vacuum.



4. When pulling out the power plug from the wall outlet, pull the plug not the power cord.

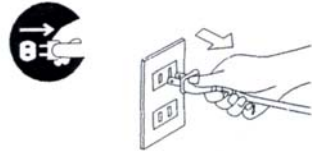

5. Do not pick up anything that is burning or smoking such as cigarettes, matches or hot ashes.



6. Do not use without all filters and paper dust bag in place.

**Note:** This vacuum cleaner is equipped with a plug and power cord that retract automatically. If the cord or plug get damaged, it must be replaced by a qualified technician.

**Warning:** Hold the plug when rewinding the cord. Do not allow the cord to whip when rewinding.

## OPERATING INSTRUCTIONS

### Flat & Upright Parking Position

Please note that your vacuum cleaner can be conveniently placed in a space saving vertical parking position. For vertical parking position, place the vacuum on its side and slide the parking position bracket that is on the telescopic tube into the parking position support that is on the underside of the vacuum. (Fig. 18)

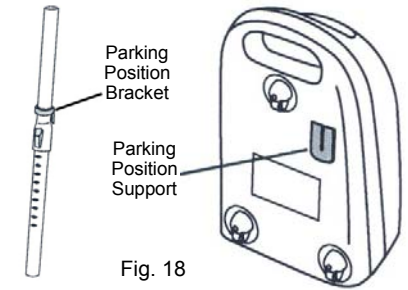

Fig. 18

## TROUBLE SHOOTING GUIDE

TROUBLESHOOTING GUIDE		
PROBLEM	POSSIBLE REASON	POSSIBLE SOLUTION
Motor runs but no suction	<ol style="list-style-type: none"> <li>1. Hose, wand or inlet is blocked.</li> <li>2. Check bag full indicator.</li> <li>3. Hose clamp not assembled to hose inlet properly.</li> </ol>	<ol style="list-style-type: none"> <li>1. Check for blockage - remove it.</li> <li>2. If dust bag is full, replace dust bag.</li> <li>3. Insert hose clamp into hose inlet until "snap" locks for proper assembly.</li> </ol>
Cord does not rewind	<ol style="list-style-type: none"> <li>1. Cord twisted.</li> <li>2. Cord pulled out too far - beyond "RED" mark.</li> </ol>	<ol style="list-style-type: none"> <li>1. Pull cord out, straighten and rewind again.</li> <li>2. Holding the plug, press the rewind button and try to rewind again.</li> </ol>
Cleaner won't run	<ol style="list-style-type: none"> <li>1. Not firmly plugged in.</li> <li>2. No electricity in wall outlet.</li> <li>3. Blown fuse/tripped breaker.</li> <li>4. Motor thermostat may have tripped.</li> </ol>	<ol style="list-style-type: none"> <li>1. Plug unit in firmly.</li> <li>2. Check fuse or breaker.</li> <li>3. Replace fuse/reset breaker.</li> <li>4. Allow unit to cool down before trying to switch "ON" again.</li> </ol>
Turbo brush does not rotate or rotates slowly	<ol style="list-style-type: none"> <li>1. Rotating brush or elbow obstructed.</li> <li>2. Hose obstructed.</li> <li>3. Dust bags full.</li> <li>4. Filters need changing.</li> </ol>	<ol style="list-style-type: none"> <li>1. Clear obstructions.</li> <li>2. Clear obstruction.</li> <li>3. Replace dust bag.</li> <li>4. Replace filters.</li> </ol>

## OPERATING INSTRUCTIONS

### Replacing the Filters

**Warning:** To reduce the risk of electric shock, the hose, power nozzle power cord and the power cord must be disconnected before changing the bag or performing maintenance/troubleshooting.

### Changing & Cleaning the Pre-Motor Filter

Your vacuum is equipped with a filtration system to reduce dust and pollen in your home as you clean. The pre-motor filter is located inside the vacuum cleaner body behind the dust bag. Check when changing the dust bag and replace when dirty.

This is a rinseable filter but should be replaced every six (6) months. Never operate the vacuum without **ALL** the filters in place

To remove, open the dust bag compartment cover and pull the pre-motor assembly out of the vacuum. Remove the filter from the filter assembly. Rinse in lukewarm water and let it air dry completely for 24 hours. Do not use a washing machine to rinse the filter. Do not use a hair dryer to dry it. Air dry only. When the pre-motor filter is completely dry, insert it in the filter assembly and replace it into the vacuum. (Fig. 16)

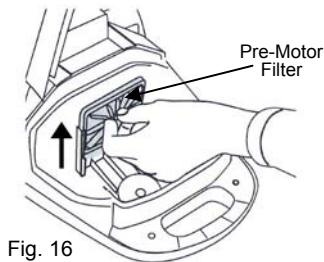

Fig. 16

### Changing & Cleaning the HEPA-Type Post Motor Filter

The HEPA-Type post motor filter should be replaced every six (6) months depending on usage. Never operate the vacuum without **ALL** the filters in place.

- Push the Power On/Off button to the "Off" position and disconnect the power cord from the wall outlet.
- The HEPA-Type post motor filter is located just underneath the dust bag compartment cover. (Fig. 17)
- Hold the HEPA-Type post motor filter assembly by the tab and pull the assembly out.
- Replace with a new HEPA-Type filter.

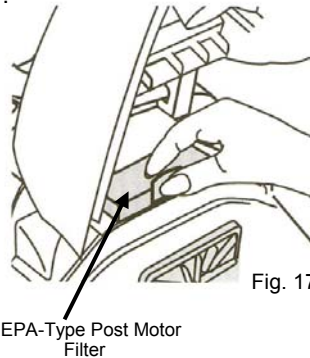

Fig. 17

### Motor Thermostat

**Important:** This unit is equipped with a motor protective thermostat. If for some reason the vacuum cleaner should overheat, the thermostat will automatically turn the unit off. Should this occur:

- Push the On/Off button once.
- Disconnect the plug from the power source.
- Check the source of overheating problem. (i.e. clogged hose or filter)
- If clogged hose or filter is found, unplug the hose and replace the filters.
- Wait at least 45 minutes before attempting to reuse the vacuum.
- After unit has cooled down for 45 minutes, plug in the cleaner and push the On/Off button. The vacuum should start again.
- If the vacuum still does not start, contact customer service at 1 (800) 798-7398.

## OPERATING INSTRUCTIONS

### Assembling Your Vacuum Cleaner

**Note:** Always remove the power plug from the wall outlet before assembling or removing accessories.

### Attaching the Flexible Hose into the Vacuum

- Connect the flexible hose into the flexible hose inlet. Push in until you hear a "click", indicating it is in its locked position. (Fig. 1)
- Connect the hose connecting power cord from the flexible hose to the power cord receptacle that is on the unit just underneath the handle. (Fig. 1)
- To remove the flexible hose first remove the power nozzle power cord from the receptacle for the power nozzle power cord, then depress locking button and remove hose.

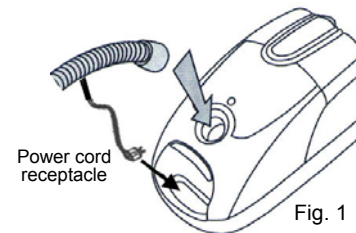

Fig. 1

### Fitting the Telescopic Tube to the Curved Wand / Hose

#### Extension

- Push the extension tube into the curved wand / hose extension, as shown in the illustration below. Make sure that the extension tube locks in place. (Fig. 2)

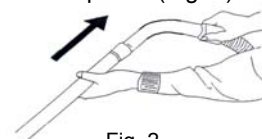

Fig. 2

### Extending the Chrome Telescopic Tube

- Push forward on the plastic button and pull the inner chrome tube outward. (Fig. 3)

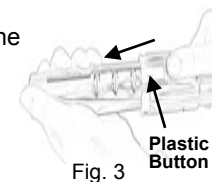

Fig. 3

### Fitting the Floor to Carpet Brush to the Telescopic Tube

- Push the telescopic tube into the floor brush as show in Fig. 4.

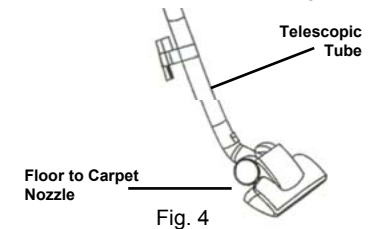

Fig. 4

### Using Power Nozzle

Connecting the power nozzle to the telescopic tube:

- Depress the button on the telescopic tube and insert it into the slot on the power nozzle elbow.
- Push the telescopic tube down until you hear a "click". (Fig. 5)

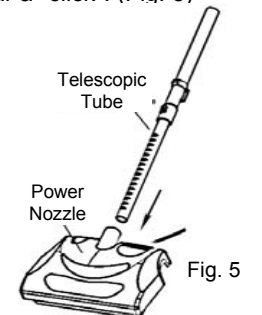

Fig. 5

- Insert the power nozzle cord plug into the power socket on the flexible hose. (Fig. 6)
- To start power nozzle press the On/Off button that is located on the power nozzle.

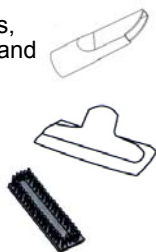

Fig. 6

## OPERATING INSTRUCTIONS

### Accessories

1. **Crevice Tool**  
For radiators, crevices, corners, baseboards and between cushions.
2. **Upholstery Tool**  
The upholstery tool is used for furniture.
3. **Upholstery Brush**  
This snaps onto the upholstery tool.



### Air Driven Turbo Brush

The efficiency of your air driven turbo brush depends on the bristle brush rotating at high speed. Strong air suction is needed to accomplish this. In order to ensure that maximum air suction is maintained, please read the following instructions:

1. Change the dust bag frequently.
2. Replace the pre-motor and post motor filters as needed.
3. Ensure that the rotating brush is kept free of hair and string which may accumulate and decrease brush performance.
4. Keep Air Driven Turbo Brush turbine free of dirt and foreign matter. (See Fig. 7 below for cleaning instructions.)

### Cleaning the Air Driven Turbo Brush

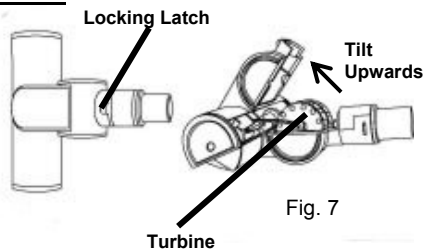

1. Slide locking latch forward then tilt the top housing of the brush upwards. The top housing is hinged and will tilt up approximately 45° only. (Fig. 7)
2. Inspect turbine wheel and air passage for debris and/or blockage. Remove debris if present.
3. Inspect the rotating brush for built-up hair or string. If present, remove by carefully cutting with scissors. Avoid damaging or cutting bristles.
4. Once clean, close the top cover of the turbo brush and slide the locking latch toward the rear of the brush to lock.

### Power Cord

Your vacuum cleaner includes a power cord which is automatically retractable. To extend the power cord, pull from the rear and extend to desired length. When cleaning is finished, first turn the unit off and disconnect from the electrical outlet. Then press on the cord rewind button to retract the power cord. If the cord does not fully retract, pull it out again and then press on the cord rewind button again. (Fig. 8)

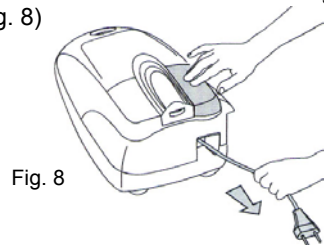

Fig. 8

- Warning:** Hold the plug when rewinding the cord. Do **NOT** allow cord to whip when rewinding.
- Caution:** Do not pull the power cord beyond the red mark on the cord as doing this will damage the cord.

### Inserting a New Dust Bag

**Warning:** To reduce the risk of electric shock, the hose, power nozzle power cord and the power cord must be disconnected before changing the bag or performing maintenance/troubleshooting.

1. To open the dust bag compartment, remove the flexible hose and the power nozzle power cord. Place your fingers in the opening indentation, lift the front cover up. (Fig. 9)
2. Remove the dust bag support from the dust bag compartment. (Fig. 10)

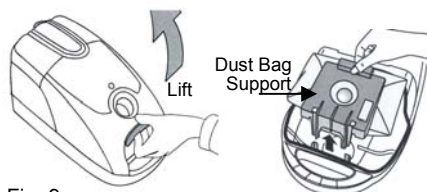

Fig. 9

Fig. 10

3. Holding the dust bag retaining clip, insert the rear part of the cardboard section of the dust bag into the plastic support. Once that rear part is in, release the retaining clip to lock the dust bag in place. (Fig. 11)

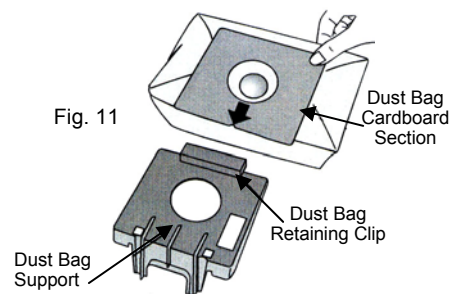

Fig. 11

- Caution:** Make sure that the dust bag cardboard section is firmly in place in the dust bag support.
4. Insert the dust bag support back into the dust bag support guides in the dust bag compartment making sure that no part of the bag is in contact with the rubber seal and that it is hanging correctly inside the dust bag compartment. (Fig. 12)

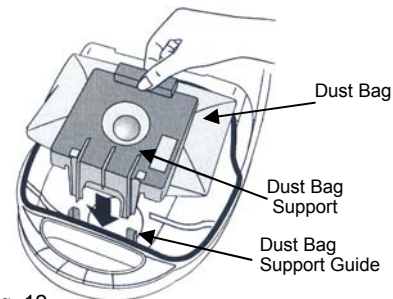

Fig. 12

- Caution:** Make sure that the dust bag support is fully inserted into the dust bag compartment.
5. Close the dust bag compartment cover.
- Caution:** The dust bag compartment will not close if the dust bag is not inserted into the unit. Never use the vacuum without a dust bag inserted into the unit. **NEVER** reuse the paper dust bags.

## OPERATING INSTRUCTIONS

### Using your Vacuum

**Note:** Once all attachments are in place, unwind a sufficient length of the power cord and insert the plug into the wall outlet. A yellow mark on the power cord shows the ideal cable length. Don't pull the power cord beyond the red mark.

1. Insert the power plug into the wall outlet.
2. Press the Power On/Off button located on the unit to turn the vacuum cleaner "On". (Fig. 13)
3. To rewind the power cord, press the cord rewind button with one hand and hold the plug of the power cord with the other hand to ensure that it does not whip causing damage or injury. (Fig. 14)

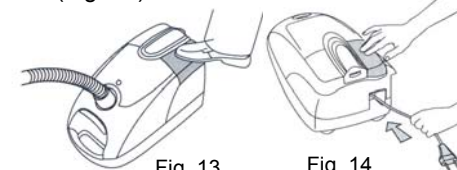

Fig. 13

Fig. 14

### Dust Bag Full Indicator

The dust bag full indicator may turn on (red) while you are cleaning to indicate that the paper dust bag is full and Requires replacement. (Fig. 15)

Always change the dust bag when the dust bag full indicator light comes on.

Follow instructions on page 5 and 6 "Inserting a New Dust Bag" when changing the paper dust bag.

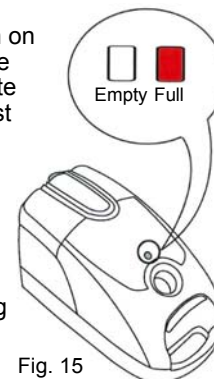

Fig. 15

## Free Manuals Download Website

<http://myh66.com>

<http://usermanuals.us>

<http://www.somanuals.com>

<http://www.4manuals.cc>

<http://www.manual-lib.com>

<http://www.404manual.com>

<http://www.luxmanual.com>

<http://aubethermostatmanual.com>

Golf course search by state

<http://golfingnear.com>

Email search by domain

<http://emailbydomain.com>

Auto manuals search

<http://auto.somanuals.com>

TV manuals search

<http://tv.somanuals.com>