

INSTRUCTION MANUAL
Digital Single Channel Recorder

DVR-100H

V1.0



About this manual

Before installing and using this unit, please read this Manual carefully.
Be sure to keep it handy for later reference.

Safety Precautions



- Refer all work related to the installation of this product to qualified service personnel or system installers.



- Do not block the ventilation opening or slots on the cover.



- Do not drop metallic parts through slots. This could permanently damage the appliance. Turn the power off immediately and contact qualified service personnel for service.



- Do not attempt to disassemble the appliance. To prevent electric shock, do not remove screws or covers. There are no user-serviceable parts inside. Contact qualified service personnel for maintenance. Handle the appliance with care. Do not strike or shake, as this may damage the appliance.



- Do not expose the appliance to water or moisture, nor try to operate it in wet areas. Do take immediate action if the appliance becomes wet. Turn the power off and refer servicing to qualified service personnel. Moisture may damage the appliance and also cause electric shock.



- Do not use strong or abrasive detergents when cleaning the appliance body. Use a dry cloth to clean the appliance when it is dirty. When the dirt is hard to remove, use a mild detergent and wipe gently.



- Do not overload outlets and extension cords as this may result in a risk of fire or electric shock.



- Do not operate the appliance beyond its specified temperature, humidity or power source ratings. Do not use the appliance in an extreme environment where high temperature or high humidity exists. Use the appliance at temperature within 0°C ~ +40°C and a humidity below 90%. The input power source for this appliance is AC100~240V.

**WARNING**

TO REDUCE RISK OF FIRE OR ELECTRIC SHOCK,
DO NOT EXPOSE THIS APPLIANCE TO RAIN OR MOISTURE.

**CAUTION**

DO NOT REMOVE COVER. NO USER SERVICEABLE PARTS INSIDE.
REFER SERVICING TO QUALIFIED SERVICE PERSONNEL.

**Note:**

This equipment has been tested and found to comply with the limits for a Class A digital device,
The changes or modifications not expressly approved by the party responsible for compliance
could void the user's authority to operate the equipment.

**Note:**

This is a class A product. In a domestic environment this product may cause radio interference
In which case the user may be required to take adequate measures.

Notice:

The information in this manual was current when published. The manufacturer reserves the right to revise and improve its products. All specifications are therefore subject to change without notice.

Safety Precautions



The lightning flash with an arrowhead symbol, within an equilateral triangle, is intended to alert the user to the presence of uninsulated "dangerous voltage" within the product's enclosure that may be of sufficient magnitude to constitute a risk of electric shock to persons



The exclamation point within an equilateral triangle is intended to alert the user to presence of important operating and maintenance(servicing)instructions in the literature accompanying the appliance.



Warning :

To prevent fire or shock hazard, do not expose units not specifically designed for outdoor use to rain or moisture.



Attention:

Installation should be performed by qualified service personnel only in accordance with the National Electrical Code or applicable local codes.



Power Disconnect:

Units with or without ON-OFF switches have power supplied to the unit whenever the power cord is inserted into the power source; however, the unit is operational only when the ON-OFF switch is in the ON position. The power cord is the main power disconnect for all units.



External Power Supplies

Use only the recommended power supplies. Power supplies must comply with the requirement of the latest version of IEC 60065/CNS 13439. Substitutions may damage the unit or cause a fire or shock hazard



AC100V~240V Power Cords

AC100V~240V power cords



Warning:

Electrostatic-sensitive device. Use proper CMOS/MOSFET handling precautions to avoid electrostatic discharge.



UNPACKING

Unpack carefully.

This is electronic equipment and should be handled carefully.

Check to ensure that the following items are included:

1. Digital Single Channel Recorder
2. User's manual
3. Power Cord
4. CF card reader
5. Adapter
6. HDD tray key and screws

If an item appears to have been damaged in shipment, replace it properly in its carton and notify the shipper. If any items are missing, notify your Everfocus Electronics Corp. Sales Representative or Customer Service. The shipping carton is the safest container in which the unit may be transported. Save it for possible future use.



Service

If the unit ever needs repair service, the customer should contact the nearest Everfocus Electronics Corp. Service Center for return authorization and shipping instruction.

Important Safeguards



Read Instruction---All the safety and operating instructions should be read before the unit is operated



Retain Instructions---The safety and operating instructions should be retained for future reference.



Heed Warnings—All warnings on the unit and in the operating instructions should be adhered to.



Follow Instructions—All operating and use instructions should be followed



Cleaning—Unplug the unit from the outlet before cleaning. Do not use liquid cleaners or aerosol cleaners.
Use a damp cloth for cleaning



Attachments—Do not use attachment not recommended by the product manufacturer as they may cause hazards.



Water and Moisture—Do not use this unit near water—for example, near a bath tub, wash bowl, kitchen sink, or laundry tub, in a wet basement, near a swimming pool, in an unprotected outdoor installation, or any area which is classified as a wet location.



Servicing—Do not attempt to service this unit yourself as opening or removing covers may expose you to dangerous voltage or other hazards. Refer all servicing to qualified service personnel.



Power Cord Protection—Power supply cords should be routed so that they are not likely to be walked on or pinched by items placed upon or against them, paying particular attention to cords and plugs, convenience receptacles, and the point where they exit from the appliance.



Object and Liquid Entry—Never push objects of any kind into this unit through openings as they may touch dangerous voltage points or short-out parts that could result in a fire or electric shock, Never spill liquid of any kind on the unit.

1. Product Overview	1
1.1 Feature.....	1
1.2 Specifications.....	2
2. Front & Rear Panels	3
3. Back Panel Connections	5
4. System Connection	8
4.1 One Camera Connection.....	8
4.2 Multiplexer Connection.....	9
4.3 Quad Connection (with VCR).....	10
4.4 Quad Connection (without VCR).....	11
5. Installation	12
6. Menu	13
6.1 Clock/Language Setup.....	14
6.2 Daylight Setting Menu.....	15
6.3 Timer Setting Menu.....	16
6.4 Normal Record Setting Menu.....	18
6.5 Alarm Record Setting Menu.....	20
6.6 Buzzer Setting Menu.....	25
6.7 Archive Setting Menu.....	26
6.8 RS232/RS485 Setting Menu.....	27
6.9 System Setting Menu.....	28
7. Recording	31
7.1 Instant Recording.....	31
7.2 Alarm Recording.....	32
8. Playback	33
8.1 Normal Playback.....	33
8.2 Search Playback.....	35
9. Copy	38
9.1 Still Image Copy.....	38
9.2 Copy to Movie File.....	39
10. Interface Specifications	41
10.1 Transmission setting.....	41
10.2 Remote Control Protocol.....	42
11. Remote Controller	45
12. Appendix-A/Time Lapse Mode Recording Time	46
12.1 Recording with and 80 GB HDD.....	46
12.2 Recording with and 160 GB HDD.....	47
13. Appendix-B/ Security Lock setting	48

1. Product Overview

The Digital Video Recorder is the first true VCR replacement designed particularly for the security industry, seamlessly combining high-resolution video multiplexing and digital recording.

The Digital Video Recorder at speeds up to 60/50 fields per second with NTSC/PAL formats and replay event instantly.

The Digital Video Recorder incorporates all the benefits of digital video recording, is simple to install, and operates just like a VCR. The highly efficient compression technology, as well as the superior clarity and detail of recorder images, make the Digital Video Recorder stand out from its competitors as the best choice for security surveillance.

1.1 Features

- Digital Recording provides superior quality images
- Hard-disk hot-swapping capability
- Pre-Alarm image recording
- Compatible with most multiplexers
- Time lapse and real time recording
- Refresh rate up to 60 fps (50 fps for PAL)
- Quick Search by date/time, alarm events, and recording list
- Fast and slow playback of recorded video in various speeds
- On-screen setup menu and system timer
- Multi-level password protection
- RS-232/RS-485 communication port
- Highly stable non-PC based proprietary system
- Built-in M-JPEG compression/decompression with configurable quality
- Audio recording capability
- Programmed with various time-lapse speeds, Data can be stored in Compact Flash Card.
- Operation status record log

1.2 Specifications

Video Input	1 video input with loop through (BNC), 1Vpp/75ohm
Video Output	1 video output (BNC), 1Vpp/75ohm
Video Compression	M-JPEG
Video Resolution	720x484 (NTSC); 720x576 (PAL)
CompactFlash Memory	Yes, Built-in Compact Flash card slot
Alarm Input	Yes
Alarm Output	Yes
Audio	2 input; 2 output
Video Loss Detection	Yes
RS-232	9-pin female connector
Event Log	Yes
Hard Disk Storage	3.5" IDE type, Hot- swappable
Recording Mode	Continuous, Time-lapse recording, Timer or Event Recording
Recording Rate	60/50 fps for NTSC/PAL
Playback Rate	60/50 fps for NTSC/PAL
Playback Search	By Date/Time or Event or Segment
Setup	On screen display setup
User Interface	Menu Driven
User Input Device	Front Panel Keypad
RS485	RJ11 Connector
Watch Dog Timer	Yes
Power Consumption	39W
Power Source	AC100~240V
Dimension	320.8mm (L) x 215mm (W) x 100mm (H)
Operating Temperature	0°C~+40°C
Timer	Built-in real time clock

2. Front Panel Keypads

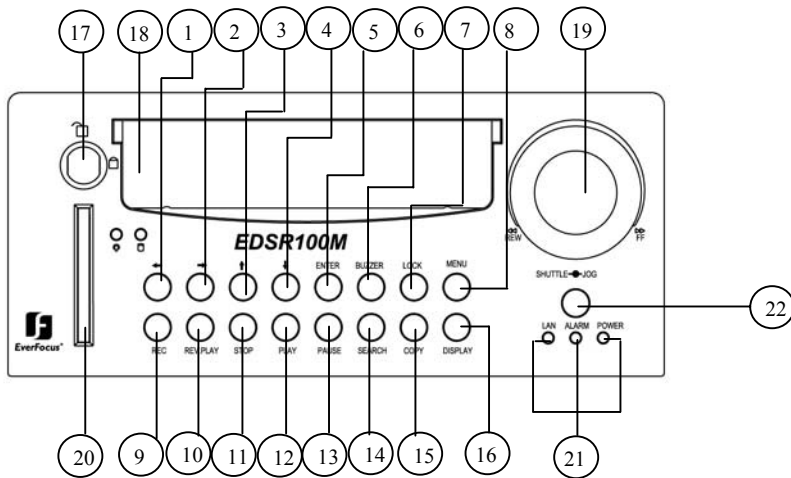

KEY

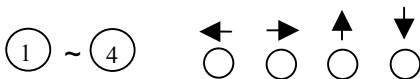

Left/Right Button: Press ← or → to move the cursor to the left or right

Up/Down Button: Press ↑ or ↓ to change the value.

- 5 **ENTER:** Press this key to confirm the selection or data changed.
- 6 **BUZZER:** Press this key to turn On/OFF the buzzer for all events.
- 7 **LOCK :** Press and hold the LOCK button over 3 seconds to lock/unlock the function keys of the front panel. This function is used to avoid unexpected contact with the panel.
- 8 **MENU:** Press this key to enter Setup menu.
- 9 **REC :** Press this key to start recording.
- 10 **REV. PLAY :** Reverse Play Back.
- 11 **STOP :** Press this key to stop recording and play back.
- 12 **PLAY:** Play Back.
- 13 **PAUSE:** Press this key to pause the playback picture.
- 14 **SEARCH:** Press this key to enter the Search Playback Menu.
- 15 **COPY:** Press this key to start copy still picture or video stream into Compact Flash card.

Display: Press this key to switch ON/OFF.

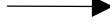

Display OFF

Display Date/Time
And Operation status



3. Back Panel Connections

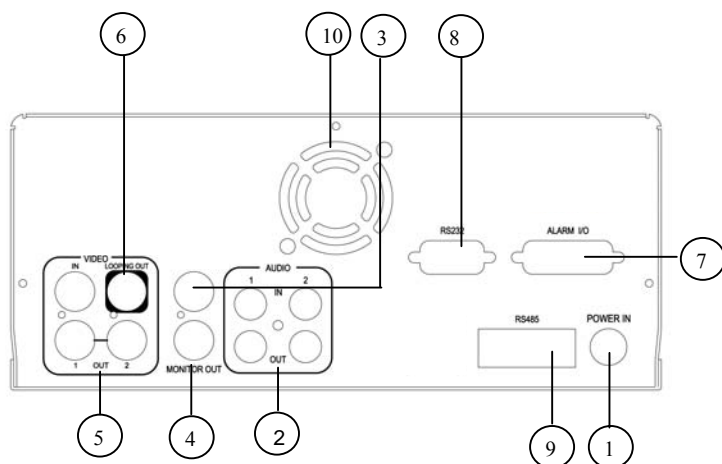

POWER

- 1 **Power in:** The main power in.

AUDIO

- 2 **Audio IN :** Audio input for recording.

Audio OUT : These two audio outputs can be set to “Enable” or “Disable” in Setup Menu.
The operation of audio out is as follows:

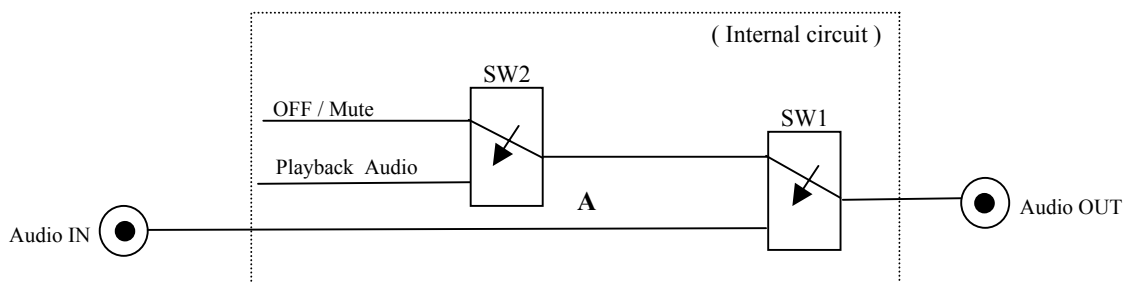

Operation of SW1 :

When in recording or standby mode,
the out of SW1 is connected to Audio IN.
When in playback mode the out of SW1 is
connected to SW2 Audio.

Operation of SW2 :

When Playback Audio is enabled then the output
of SW2 will be connected to Playback Audio.
When Playback Audio is disabled then there is no
audio output (MUTE).

When Audio Out is enabled and machine is in Recording or Standby mode, the Audio IN is loop-through to Audio Out connector.

When Audio Out is enabled and machine is in Playback mode then the Audio Out playback audio.

MONITOR

- 3 **MUX MAIN MONITOR:** Video input BNC connector, connected to multiplexer main monitor output.
- 4 **MONITOR :** Video output BNC connector connected to main monitor.

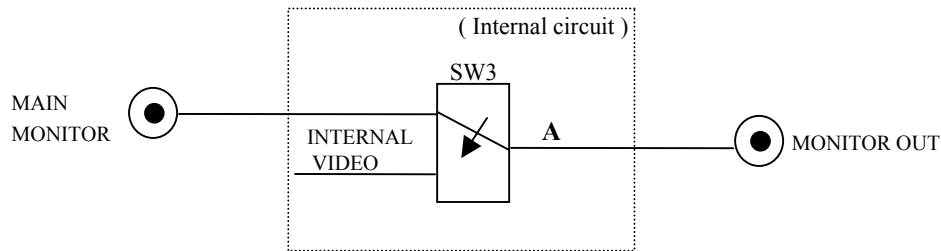

When the machine is in Menu, Search or Copy mode, the internal Video is switched to Monitor Out, so that the user can view full screen OSD. In other modes, the Video from multiplexer main monitor will be loop-through to the Monitor Out.

VIDEO IN /Output

- 5 **VIDEO IN :** The BNC connectors of video input enables the system to receive the signals from each camera through the 75 ohm coaxial cables.
VIDEO OUT(1~2) : Connect the other devices with four cameras to the other devices.
- 6 **VIDEO LOPPING :** The loop-through composite video input can be connected to other devices.

Alarm Input/ Output

- 7 **ALM-INPUT :** Normal Open or Normal Close type alarm sensor input.
The Alarm Input can be selected as Normal Open or Normal Close input in the setup menu. When an alarm occurs, alarm recording will automatically start.
ALM-OUTPUT : Normal Close Alarm output. In normal condition, this terminal is shorted to the terminal of ALM-COM. In alarm status, it is open between ALM-NC and ALM-COM terminals.

RS232

8 **RS232 connector** : Connect D-Sub 9 pins connector to RS232 ports for remote control

RS485

9 **RS485 connector** : Cascade multi Digital Video Recorder.

10 **FAN**: Cooling FAN.

4.1 One Camera Connection.

(1)

(2)

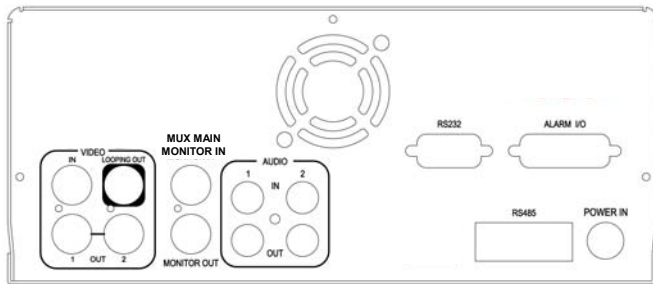

(3)



Main Monitor

(1) :Video out:

The Camera Video Output is connected to the Video In at the rear panel.

(2) : Audio Out:

The camera audio output is connected to the audio input terminal at the rear panel.

(3) : System Main Monitor Output:

The main monitor is connected to the VIDEO OUT 1 BNC connector.

4.2 Multiplexer Connection.

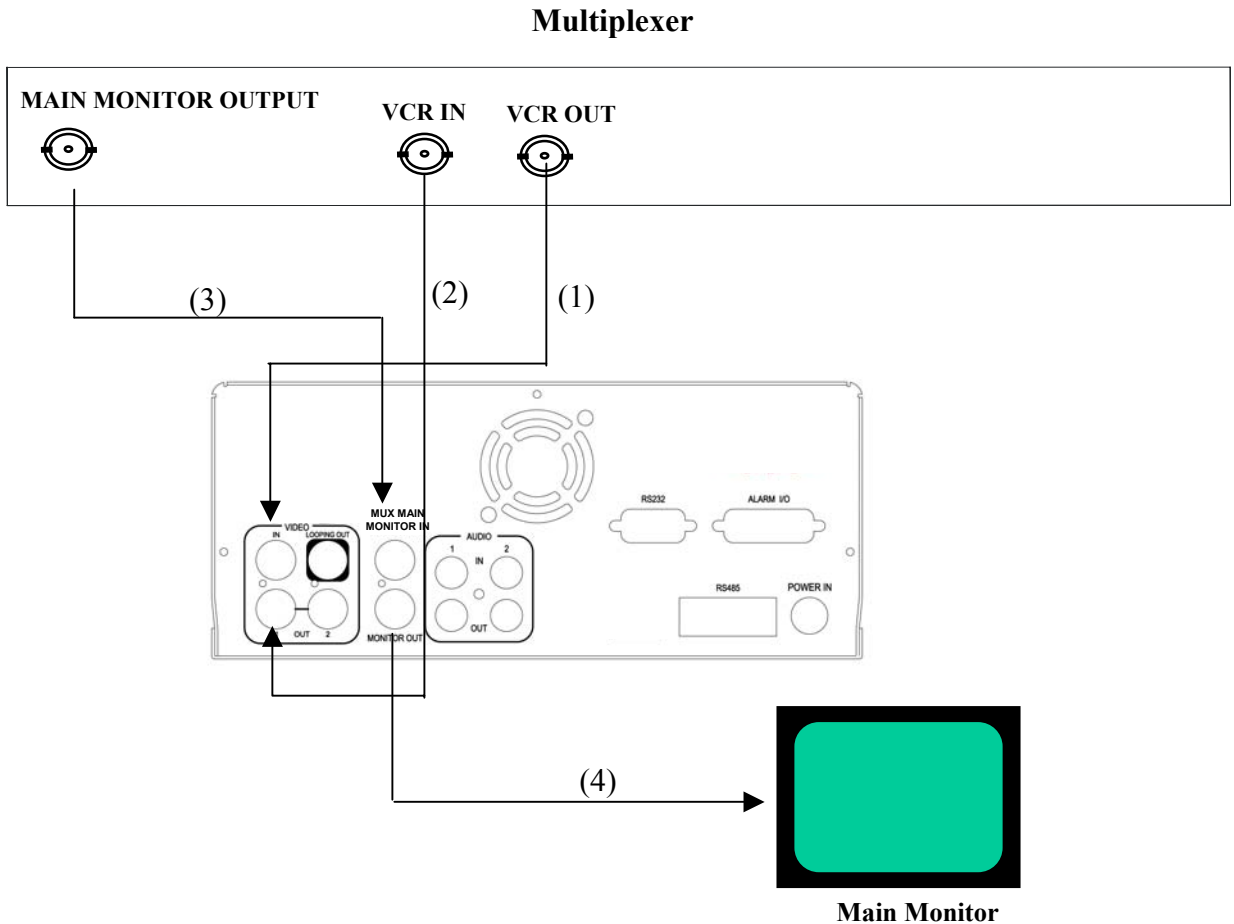

(1): Multiplexer VCR Out :

This connects to the VIDEO IN connector at the rear panel.

(2) :Multiplexer VCR In :

This connects to the VIDEO OUT 1 connector at the rear panel.

(3) :Multiplexer Main Monitor Output:

This connects to the MUX. MAIN MONITORIN IN connector at the rear panel.

(4) :System Main Monitor Out:

Connect the MAIN MONITOR OUTPUT connector to the main monitor.

Note: Please set the Multiplexer item to ON . (NORMAL RECORD SETTING MENU)

4.3 Quad Connection. (Quad with VCR in VCR out connector)

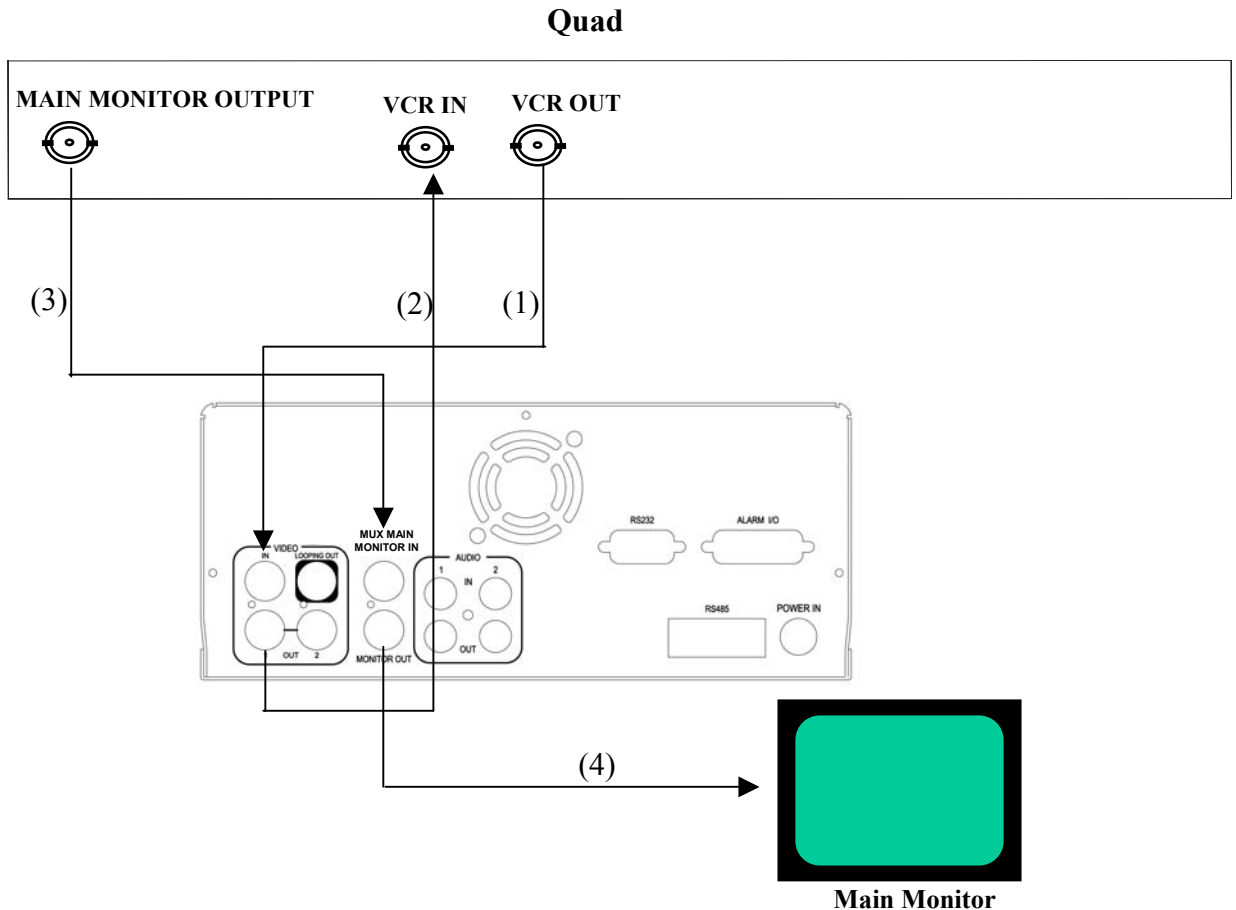

(1): Quad VCR Out:

This connects to the VIDEO INPUT connector at the rear panel.

(2): Quad VCR In:

This connects to the VIDEO OUTPUT connector at the rear panel.

(3): Quad Main Monitor Out:

This connects to the MUX. Main connector at the rear panel.

(4): System Main Monitor Output:

Connect the MAIN MONITOR OUTPUT connector to the main monitor.

Note: Please set the Multiplexer item to ON . (NORMAL RECORD SETTING MENU)

4.4 Quad connection. (Quad without VCR in VCR out connector)

Quad

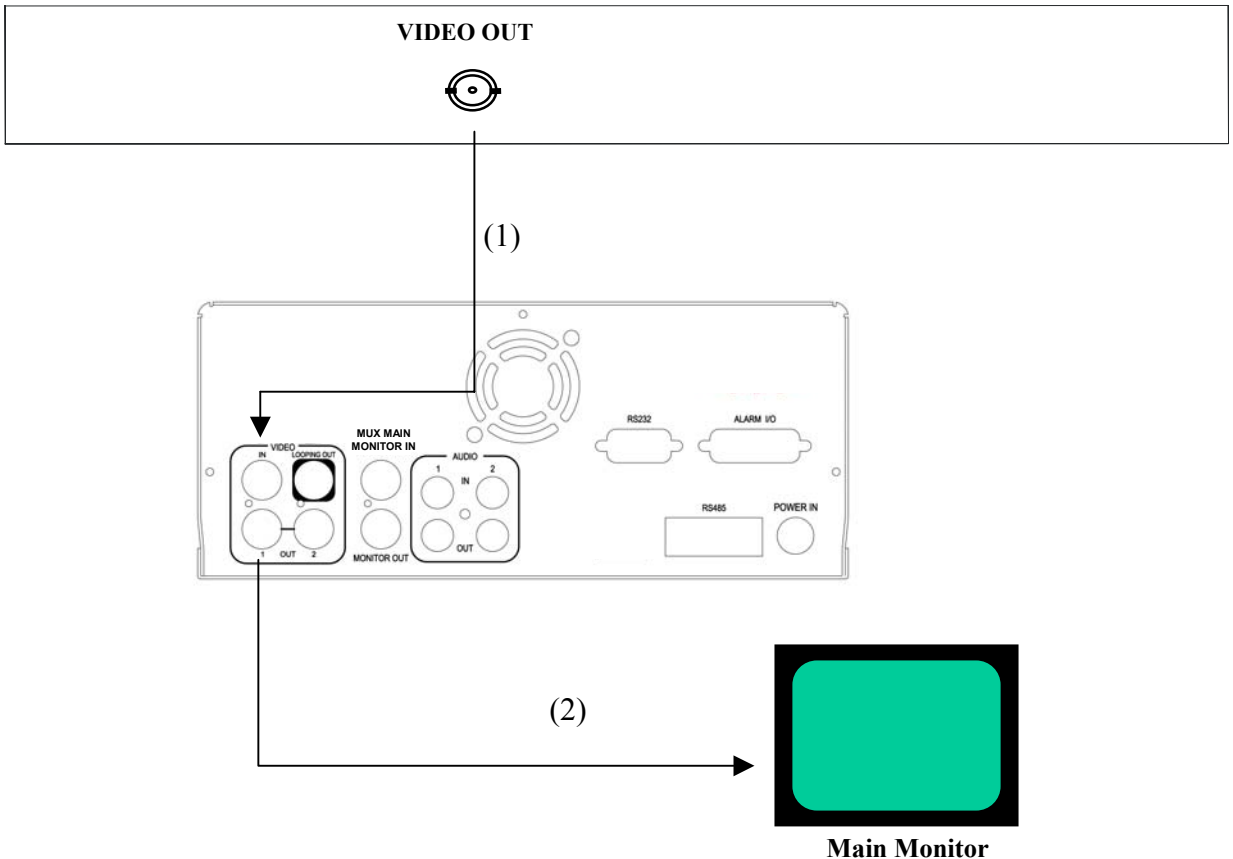

(1): Quad Video Out (to Video Recorder):

This connects to the VIDEO INPUT connector at the rear panel.

(2): System Main Monitor Output:

Connect the MAIN MONITOR connector to the main monitor.

Note: Please set the Multiplexer item to OFF . (NORMAL RECORD SETTING MENU)

5. Installation

(1) Insert a HDD (IDE) for Video Storage

The HDD should be set as MASTER.
(Normally the default setting of HDD is Master)

Notice: After the hard disk case is inserted into the hard disk tray, be sure to Turn the tray key in lock position. Otherwise, hard disk will not be detected and The System Loading procedure can not be completed.

(2) Connect cable for video/audio input and video/audio out,

The POWER LED lights if power is normal.

(3) Switch Power On

The detail connection is described in SYSTEM CONNECTION.

(4)

MENU



Press MENU key to enter SET UP MENU.

Once inside the main menu you will find there are nine set up pages as below:

1. **CLOCK/LANGUAGE SETTING MENU**
2. **DAYLIGHT SAVE SETTING MENU**
3. **TIMER SETTING MENU**
4. **NORMAL RECORD SETTING MENU**
5. **ALARM RECORD SETTING MENU**
6. **BUZZER SETTING MENU**
7. **ARCHIVE SETTING MENU**
8. **RS232/RS485 SETTING MENU**
9. **SYSTEM SETTING MENU**

(5)

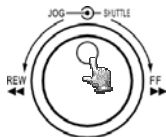

Turn the jog dial clockwise or counterclockwise to change set up page.

6. MENU FLOW

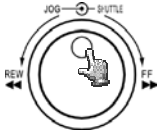

Turn the Jog dial clockwise or counterclockwise to change setting menu page.

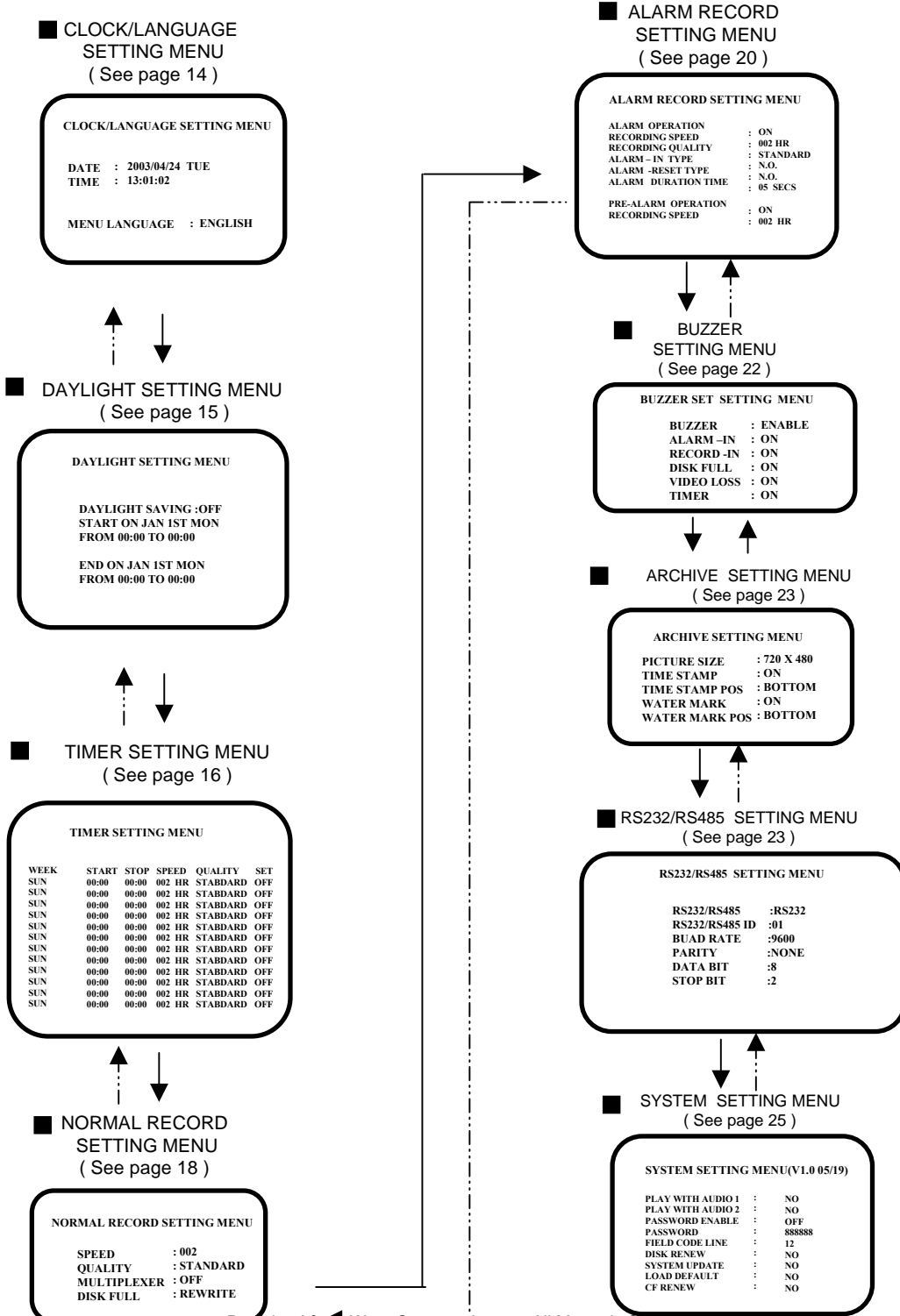

6.1 CLOCK/ LANGUAGE SETTING MENU



In CLOCK/LANGUAGE SETTING MENU , we SET

- (1) **DATE** : Current date
Year: 2000 ~ 2099 Month: 01~ 12 Date: 01~31
- (2) **TIME** : Current time
Hour: 00 ~ 23 Minute : 00 ~ 59 Second: 00 ~ 59
- (3) **MENU LANGUAGE:**
ENGLISH

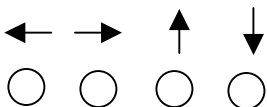

Left/Right Button: Press ← or → to move the cursor to the left or right
Up/Down Button: Press ↑ or ↓ to change the value.

6.2 DAYLIGHT SETTING MENU

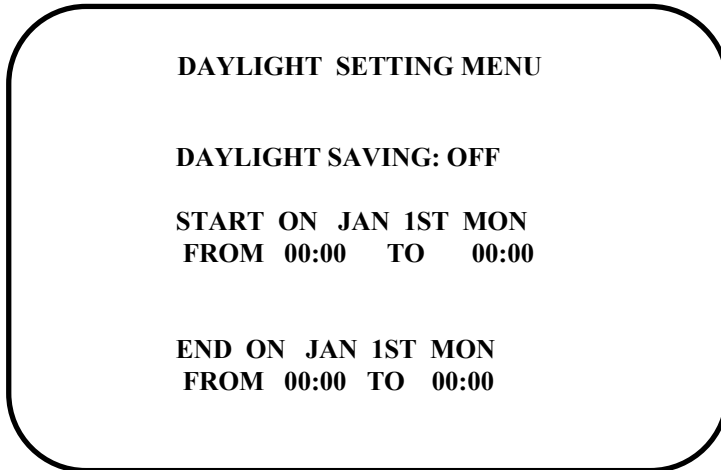

In DAYLIGHT SETTING MENU , we define:

- (1) DAYLIGHT SAVING:
Select “ON” or “OFF” while the daylight saving time function is enabled or not.
- (2) START ON:

“JAN” Use the arrow to set the present month

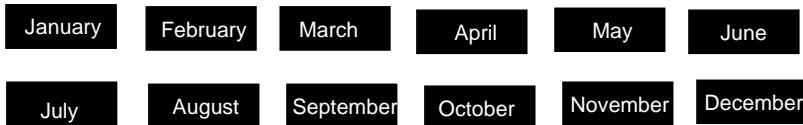

“1ST” Use the arrows to set the present week



“SUN” Use the arrow to set the present date

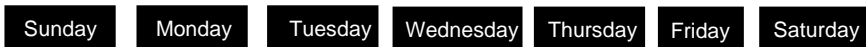

“FROM” 00:00 “TO” 00:00: Use the arrow to set the start time value.

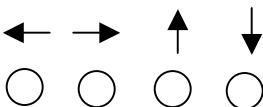

Left/Right Button: Press ← or → to move the cursor to the left or right
Up/Down Button: Press ↑ or ↓ to change the value.

6.3 TIMER SETTING MENU

TIMER SETTING MENU

WEEK	START	STOP	SPEED	QUALITY	SET
SUN	00:00	23:59	002 HR	STANDARD	OFF
SUN	00:00	23:59	002 HR	STANDARD	OFF
SUN	00:00	23:59	002 HR	STANDARD	OFF
SUN	00:00	23:59	002 HR	STANDARD	OFF
SUN	00:00	23:59	002 HR	STANDARD	OFF
SUN	00:00	23:59	002 HR	STANDARD	OFF
SUN	00:00	23:59	002 HR	STANDARD	OFF
SUN	00:00	23:59	002 HR	STANDARD	OFF
SUN	00:00	23:59	002 HR	STANDARD	OFF
SUN	00:00	23:59	002 HR	STANDARD	OFF
SUN	00:00	23:59	002 HR	STANDARD	OFF
SUN	00:00	23:59	002 HR	STANDARD	OFF

In **TIMER SETTING MENU**, we define

The monitored image can be recorded automatically by setting the start and end times in **TIMER SET SETTING MENU**, we can set the schedule to record for a whole week.

(1) WEEK:

This selects the day for the timer .Records each day's schedule.

(2) START:

This key is used to start the timer recording.

(3) STOP:

This key is used to end the time for recording.

(4) Speed :

When SPEED FORMAT is set to HOUR, the recording speed can be set from 2/3 (NTSC/PAL)HR to 960HR.

When SPEED FORMAT is set to IPS, the recording speed can be set from 1~60/1~50(NTSC/PAL)IPS.

(5) QUALITY:

Picture Quality

There are six quality levels for recording

LOWER	:	15 KB
LOW	:	20 KB
BASIC	:	25 KB
STANDARD	:	30 KB
HIGH	:	35 KB
SUPERIOR	:	40 KB

(6) SET:

Set "ON" when using timer recording.

Set "OFF" when not using timer recording

6.4 NORMAL RECORD SETTING MENU

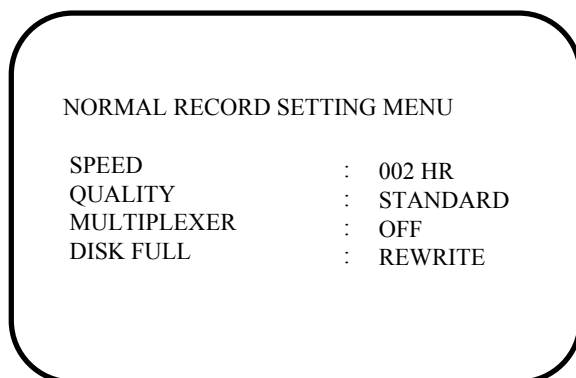

In NORMAL RECORDING MENU, we define

(1) **SPEED** : Recording Speed
The user can select the recording speed from 2/3 (NSC/PAL) HR to 960 HR.

(2) **QUALITY**:
Picture Quality
There are six quality levels for recording

LOWER	:	15 KB
LOW	:	20 KB
BASIC	:	25 KB
STANDARD	:	30 KB
HIGH	:	35 KB
SUPERIOR	:	40 KB

(3) MULTIPLEXER:

ON/OFF : The user can select Multiplexer connection or One Camera connection

ON : The video input from MUX MAIN MONITOR connector at the rear panel will be looped through to the main monitor out when the recorder is not in MENU mode.

OFF : The main monitor output is similar to the video out connector.

(4) Disk Full:

STOP : When the disk is full, the machine will STOP recording.

REWRITE : When the disk is full, the current video will OVERWRITE the existing video from the beginning of HDD.

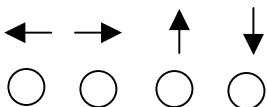

Left/Right Button: Press ← or → to move the cursor to the left or right
Up/Down Button: Press ▲ or ▼ to change the value.

6.5 ALARM RECORD SETTING MENU

ALARM RECORD SETTING MENU

ALARM OPERATION	: ON
RECORDING SPEED	: 003 HR
RECORDING QUALITY	: STANDARD
ALARM - IN TYPE	: N.O.
ALARM -RESET TYPE	: N.O.
ALARM DURATION TIME	: 05 SECS
PRE-ALARM OPERATION	: ON
RECORDING SPEED	: 003 HR

In ALARM RECORDING MENU, we define

(1) ALARM OPERATION :

ON : Records when alarm occurs.

OFF : Does not record when alarm occurs.

(2) RECORDING SPEED : The recording speed in alarm duration.

The max. recording speed is 2/3 (NTSC/PAL) HR.

The min. recording speed is 960 HR.

(3) RECORDING QUALITY :

Select the Recording picture quality when alarm occurs.

LOWER	:	15 KB
LOW	:	20 KB
BASIC	:	25 KB
STANDARD	:	30 KB
HIGH	:	35 KB
SUPERIOR	:	40 KB

(4) ALARM -IN TYPE :

N.O. : Normal Open,
N.C. : Normal Close

(5) ALARM - RESET TYPE:

N.O. : Normal Open,
N.C. : Normal Close

(6) ALARM DURATION TIME :

Alarm recording starts from the beginning of alarm and stops at the end of the duration.
The max. duration is NON - STOP, the min. duration is 5 Seconds.

(7) PRE-ALARM OPERATION :

ON : Record the picture in pre-alarm recording speed in pre-alarm period.
OFF : No pre-alarm recording before alarm occurs.

(8) RECORDING SPEED :

This is the recording speed in the pre-alarm period.
The max. recording speed is 2/3 (NTSC/PAL) HR.
The min. recording speed is 960 HR.

(9) PRE - ALARM TIME :

The duration of pre-alarm recording period
In 2/3 hour Real Time recording mode, the duration of pre-alarm is about five seconds.

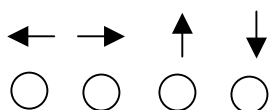

Left/Right Button: Press ← or → to move the cursor to the left or right
Up/Down Button: Press ↑ or ↓ to change the value.

Notice :

If the alarm occurs when it is in standby mode or in normal recording mode, the recording quality will be the same as the normal recording quality.

If the alarm occurs when it is in timer recording mode, the recording quality will be the same as the value set in timer recording quality.

Note:

(a.) Alarm out

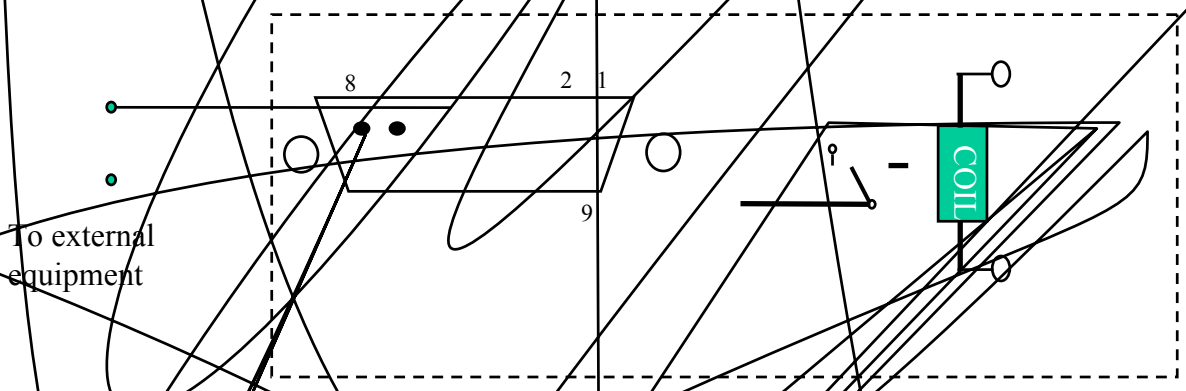

Normally Closed Connection (use pin # 13 and # 12)

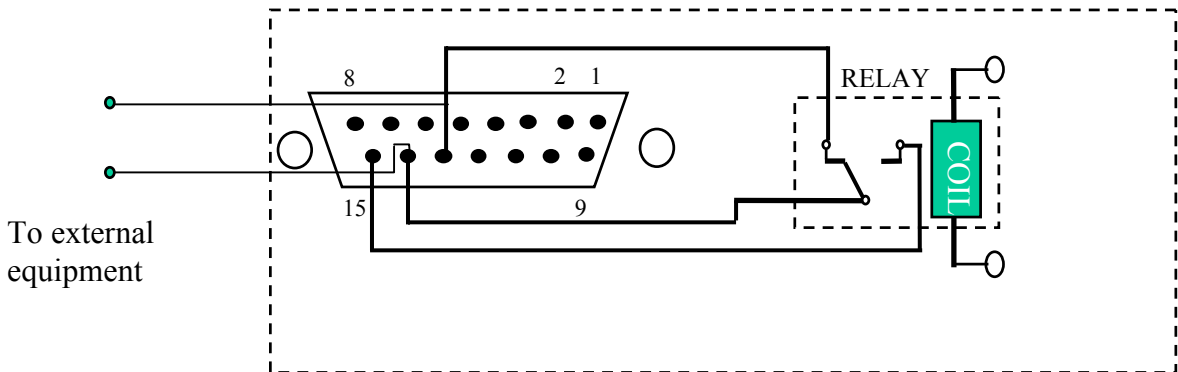

(c) Alarm in and alarm reset

There is 1 alarm sensor in for 1 channel and 1 alarm reset in, the alarm input can be set to Normally Open or Normally Closed by user.

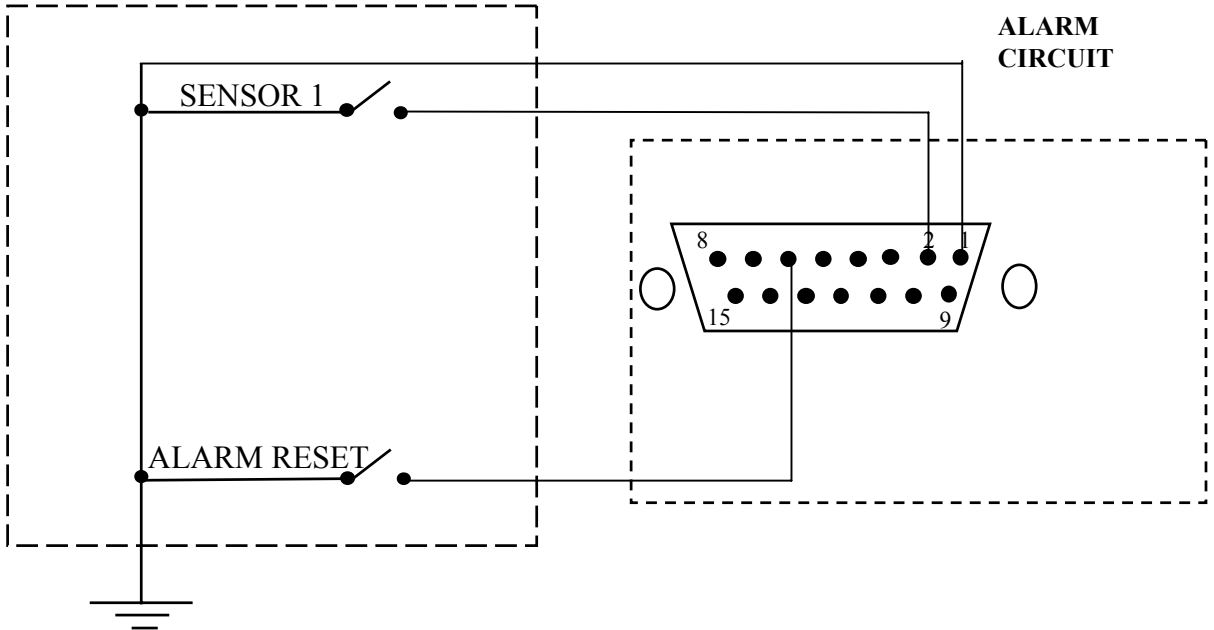

Alarm in

There is one alarm input. Please connect the alarm input in the same sequence as the camera input BNC.

When alarm signal comes in, the Digital Video Recorder will do the following:

1. Display Alarm Message
2. Turn on the buzzer if the buzzer setting is on.

The **ALARM in** can be selected as normally open input or normally closed input:

Normally Open : If the alarm input is selected as Normally Open input, then the (N.O.) input is opened normally, and shorted to the ground means an alarm happens.

Normally Close : If the alarm input is selected as Normally Close input, then the (N.C.) input is shorted to the ground normally, and opened input means an alarm happens.

6.6 BUZZER SETTING MENU

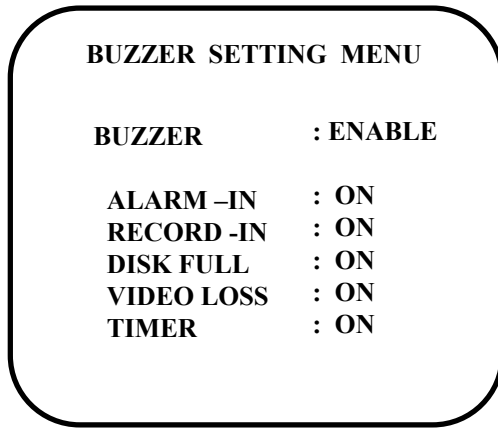

In BUZZER SETTING MENU, we SET the buzzer ON/OFF under the following conditions:

(1) BUZZER :

ENABLE: Turns the buzzer on.
DISABLE: Turns the buzzer off.

User can press Enter button to enable/disable in Record/Playback mode.

(2) ALARM -IN :

ON, the buzzer will sound when the alarm occurs.

(3) RECORD - IN:

ON, the buzzer will sound when Record-IN signal is applied on the Record-IN terminal.

(4) DISK FULL :

ON, the buzzer will sound when disk is near full 99.7%

(5) VIDEO LOSS :

ON, the buzzer will sound when the video loses.

(6) TIMER :

ON, the buzzer will sound when timer record occurs.

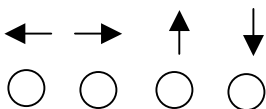

Left/Right Button: Press ← or → to move the cursor to the left or right
Up/Down Button: Press ↑ or ↓ to change the value.

6.7 ARCHIVE SETTING MENU

ARCHIVE SETTING MENU

PICTURE SIZE	: 720x576
TIME STAMP	: ON
TIME STAMP POS	: BOTTOM
WATER MARK	: ON
WATER MARK POS	: BOTTOM
MULTIPLEXER	: NONE

(1) PICTURE SIZE :

Selects picture size for copying image to CF card

Big size:720x576

Small size:352x288

(2) TIME STAMP :

ON: The time stamp will show on the picture when copying image to CF card.

OFF: The time stamp will not show on the picture when copying image to CF card.

(3) TIME STAMP POS:

BOTTOM: The time stamp will show on the bottom

TOP: The time stamp will show on the top

(4) WATER MARK:

ON: Shows a water mark on the picture when copying image to CF card.

OFF: This erases the water mark on the picture when copy image to CF card.

(5) WATER MARK POS:

BOTTOM: Water mark will show on the bottom

TOP: Water mark will show on the top

(6) MULTIPLEXER:

Multi-brand of multiplexer for user choose: NONE/EVERFOCUS 4BDX/EVERFOCUS 4CDX/EVERFOCUS 16CTX/ROBOT MU99P/APPRO MPX-9016/DM NPRITE4 /ATV QSP-860MPX

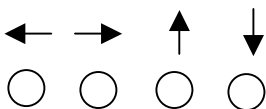

Left/Right Button: Press ← or → to move the cursor to the left or right
Up/Down Button: Press ↑ or ↓ to change the value.

6.8 RS232/RS485 SETTING MENU

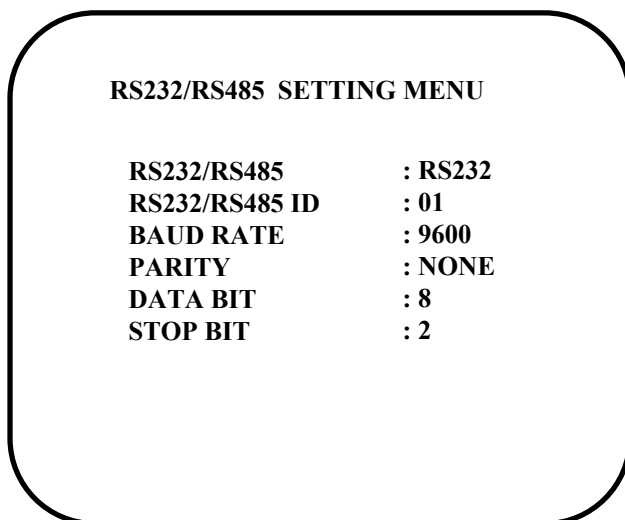

In the RS232/RS485 SETTING MENU, we define

(1) **RS232/RS485:** Choose RS232 or RS485 for activated.

(2) **RS232/RS485 ID:** This entry is used to assign each device with its own ID code, when more than one unit is used in one system through RS232/RS485.

There are two ID code for the Digital video recorder : 001 or 002

(3) **BAUD RATE:** There are 6 different speeds that can be used to transmit instruction or information through the RS232/RS485 port on the device, 1200 baud, 2400 baud, 4800 baud, 9600 baud, 19200 baud, and 38400 baud. The default setting from the factory is 9600 baud.

(4) **PARITY:** Select parity level: NONE/ODD/EVEN

(5) **DATA BIT:** Select data bit : 8 or 7

(6) **STOP BIT:** Select stop bit: 1 or 2

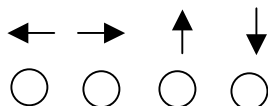

Left/Right Button: Press ← or → to move the cursor to the left or right
Up/Down Button: Press ↑ or ↓ to change the value.

6.9 SYSTEM SETTING MENU

SYSTEM SETTING MENU

PLAY WITH AUDIO 1	: NO
PLAY WITH AUDIO 2	: NO
PASSWORD ENABLE	: OFF
PASSWORD	: 888888
FIELD CODE LINE	: 12
DISK RENEW	: NO
SYSTEM UPDATE	: NO
LOAD DEFAULT	: NO
CF RENEW(FAT16)	: NO

(1) PLAY WITH AUDIO 1

PLAY WITH AUDIO 2 :

ON/OFF : Play back with or without audio.

(2) PASSWORD ENABLE :

YES/NO : User can set the PASSWORD ON or OFF to enter the system setting menu.

YES: Selects the PASSWORD to enter the system setting menu .

NO: Turns off the PASSWORD to enter the system setting menu.

(3) PASSWORD :

When selecting YES for PASSWORD ENABLE, to unlock key a password is required. The code is six digits long and can be a digit from 1 to 8.

Once you have activated the password, whenever you press the LOCK button for unlock the system will ask you to enter the password.

PASSWORD: *****

Therefore, be sure to make a note of the password.

(4) FIELD CODE LINE : When the system is connected to the Multiplexer, it is used to adjust the field code of the Multiplexer.

The values: 00~20

The default value is 13, it is suitable for most of the multiplexers.

If the field code line appears on the top of each playback channel, decrease the value.

If multiplexers can not playback properly ,increase the value.

(5) DISK RENEW :

YES/NO : Activates the Renew HDD option.

DISK RENEW	
<input type="checkbox"/> NO	<input type="checkbox"/> YES

Press NO to renew HDD and Press ENTER key to Exit.

DISK RENEW	
<input type="checkbox"/> NO	<input checked="" type="checkbox"/> YES

Press Yes to Renew HDD and Press ENTER key to Exit.

(6) SYSTEM UPDATE :

YES/NO : Updates the system.

YES : Copy the update files into Compact Flash card ON PC and insert the Compact Flash card into the slot, and then press ENTER key to update system.

The “ Reading Program.....” will be shown on the screen during the process.

The “ Success” will be shown on the screen after system update.

Notice: After the system is updated successfully, be sure reboot the system.

(7) LOAD DEFAULT :

LOAD DEFAULT
<input type="checkbox"/> NO <input type="checkbox"/> YES

Press **NO** to load default and Exit.

LOAD DEFAULT
NO <input type="checkbox"/> YES

Press **YES** to load default value.

(8) CF RENEW:

CF RENEW
<input type="checkbox"/> NO <input type="checkbox"/> YES

Two of modes for choice, **YES** or **NO**.

NO: will not format CF card

CF RENEW
NO <input type="checkbox"/> YES

YES: will format CF card

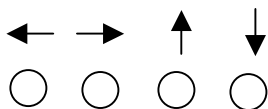

Left/Right: Press ← or → to move the cursor to the left or right
Up/Down: Press ↑ or ↓ to change the value.

7.1 INSTANT RECORDING

- Press Record key to start the recording immediately.



REC

When pressed, the pictures being monitored will be recorded in the HDD.

- The recording rate and recording quality are set in the Record Set menu
- “ REC ” button light up in the operating display

Video out

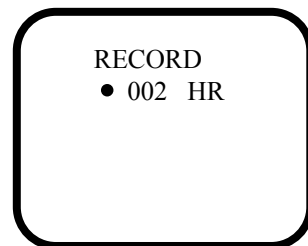

STOP

Press Stop key to stop recording.

- Stop key can be activated only in recording mode.

- When the HDD is full, the machine will Stop recording automatically or Overwrite from the beginning of the HDD. It depends on the setting in HDD setting

7.2 ALARM RECORDING

The monitor image will automatically record when alarm occurs and stops recording at the end of the alarm duration period.

Instant recording and timer recording will stop when an alarm occurs.

MENU



Press MENU key and turn the jog dial to select the ALARM RECORDING SETTING MENU.

■ RECORDING OPERATION:

ON: Enables alarm recording,
OFF: Disables alarm recording.

■ RECORDING SPEED:

Set the recording speed when alarm occurs.

■ RECORDING QUALITY:

In alarm duration, the recording quality can be set which is different from instant or timer recording.

■ ALARM – IN TYPE:

Select the type of alarm-in input to be Normal Close (N.C.) or Normal Open (N.O.)

■ ALARM – RESET TYPE:

Select the type of alarm-reset input to be Normal Close (N.C.) or Normal Open (N.O.)

■ ALARM DURATION TIME:

Alarm duration from 5 seconds to NON – STOP.

■ PRE-ALARM OPERATION:

ON: Enables pre-alarm recording,
OFF: Disables pre-alarm recording.

■ RECORDING SPEED:

Set the recording speed in pre-alarm duration.

Notice:

The recording quality in pre-alarm duration is the same as recording quality before alarm occurs. If the recorder is not recording before alarm occurs, the recording quality in pre-alarm duration will be the same as instant recording quality.

8.1 NORMAL PLAYBACK

(1) Playback



PLAY

Press the PLAY key to start playing back the stored image/audio from the last SEGMENT.



REV.PLAY

Press the REV.PLAY key to start reverse playing back the stored image/audio from the last segment.

(2) STOP



STOP

Press the STOP key to stop playing back.

(3) Fast Forward/Reverse Playback



PLAY

Press the PLAY key to start playing back.

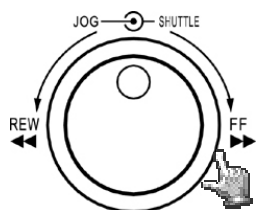

Turn the shuttle dial clockwise and fast forward playback starts.
The speed will be shown on the LCD at the right upper corner of the screen.
>> 2, 4, 6, 8, 16, 32, 600X

Turn the shuttle dial counterclockwise and fast reverse playback starts.
The speed will be shown on the LCD.
<< 2, 4, 6, 8, 16, 32, 600X

(4) Slow Forward/Reverse Playback



PAUSE

Press PAUSE key to freeze the playing back picture.

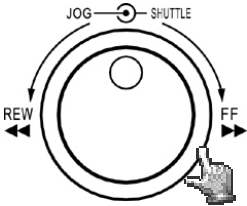

Turn the shuttle clockwise and slow forward playback starts.
The speed will show on the LCD at the corner of the screen.

>> 1/2, 1/4, 1/6, 1/8, 1/10, 1/16, 1/32

Turn the shuttle counterclockwise and slow reverse playback starts.
The speed will show on the LCD at the corner of the screen.

<< 1/2, 1/4, 1/6, 1/8, 1/10, 1/16, 1/32

(5) Frame/Field advance Forward/Reverse



PAUSE

Press PAUSE key to freeze the picture.

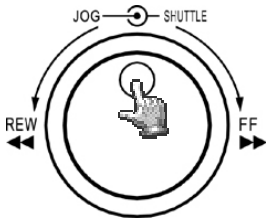

Turn the jog dial clockwise to advance the still image Frame/Field by Frame/Field .

Turn the jog dial counterclockwise to rewind the still image Frame/Field by Frame/Field .

The Frame/Field feed speed will increase if the jog dial is turned quickly.

8.2 SEARCH PLAYBACK

(1) Segment Search Playback



SEARCH

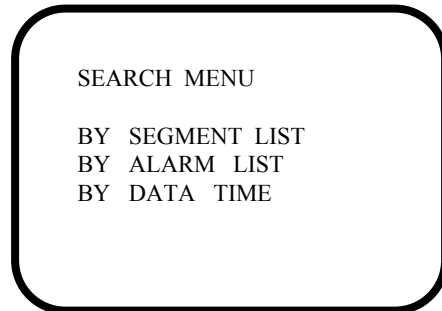

Press the SEARCH key to enter the Search menu.

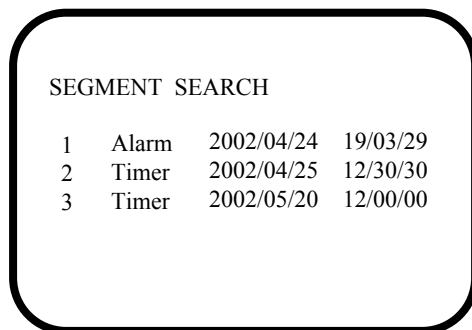

Press the   keys to move the cursor to BY SEGMENT LIST and press ENTER key to select file search.



Alarm:ALARM RECORD
Timer: TIMER RECORD

Press the   keys to move the cursor to the segment you want to playback. Press Enter to select the segment.
When the selection list is full, turn the jog dial clockwise to select next page list for search other list.
After the starting time is confirmed, press Enter to start playing back.



(2) Alarm Search Playback



SEARCH

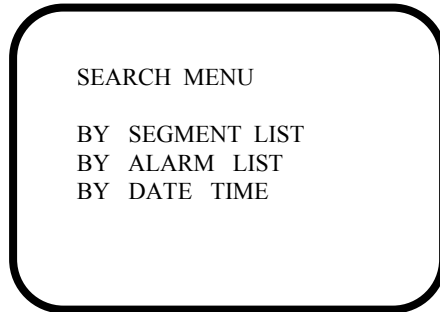

Press SEARCH key to enter the Search menu.

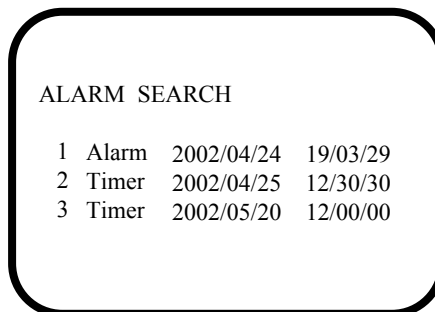

Press the   keys to move the cursor to BY ALARM LIST and press ENTER key to select alarm search.



Alarm : PRE-ALARM RECORD
Timer : TIMER RECORD

Press the   keys to move the cursor to select the alarm image to be played back. When the selection list is full, turn the jog dial clockwise to select next page for search other list.
The alarm image will be played back from the pre-alarm period and stop at the end of alarm duration.



(3) Date/Time Search Playback



SEARCH

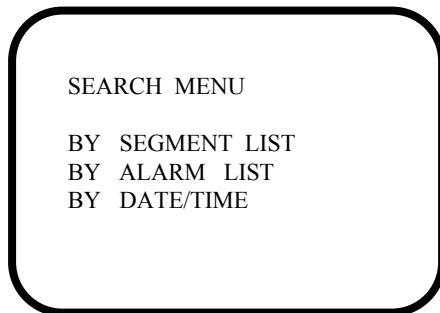

Press SEARCH key to enter the Search menu.

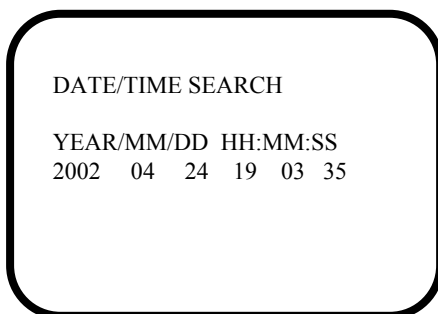

Press the   keys to move the cursor to BY DATE/TIME and press ENTER key to select file search.



Press the   keys to move the cursor.

Press the   keys to increase/decrease the data.
Press Enter and the playback starts from the date/time set in the menu.

Notice: If there is no image stored in the date/time specified then the machine will start playing back from the nearest set time automatically.

9. COPY

Insert a Compact Flash card into the Compact Flash slot on the front panel.

When inserting the Compact Flash card, make sure that the direction of insertion is correct.

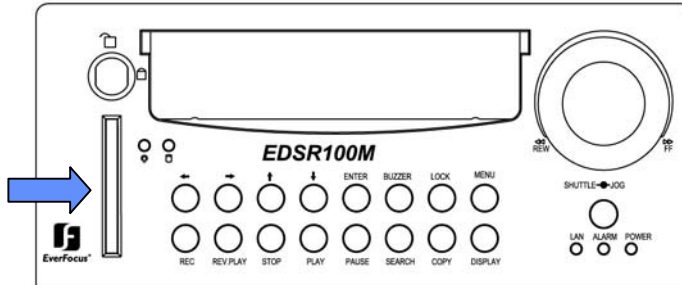

9.1 STILL IMAGE COPY



PLAY

Press the **PLAY** key to start playing back.



PAUSE

Press the **PAUSE** key to freeze the picture.

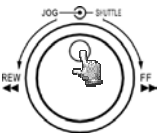

Turn the **jog dial** clockwise or counterclockwise to move to your desired image of choice .



COPY

While the image to be displayed as your desired image of choice , press the **COPY** key. The “ Copying ...” will be shown on the screen during the process. The “ Success” will be shown on the screen after file copied

Notice: Copied images are stored as a single picture.
Copied files are saved as .JPG file.

9.2 COPY TO MOVIE FILE



PLAY

Press the **PLAY** key to start playing back.



COPY

Press **COPY** key and then the copy menu appears.

COPY TO MOVIE FILE	
Press COPY	To Step Copy
Press PLAY	To Continue Copy
Press PAUSE	To Stop Continue
Press SEARCH	To End Copy
Press STOP	To End Play



PLAY

Press **PLAY** key to continue Copy Movie File.



PAUSE

Press the PAUSE key to stop continue copy.



SEARCH

Press SEARCH key to end copy.



STOP

Press STOP key to end play.

Notice: Copied images are stored as a movie picture.
Copied files are saved as .MOV file.
Use QuickTime to play the retrieved .MOV files.
You may download QuickTime at www.apple.com.
The playback version for QuickTime is free.

This Digital Single Channel Recorder may be controlled by a computer or a terminal via the standard D-SUB 9-pin RS-232 connector.

■ D-SUB 9-pin connector specifications

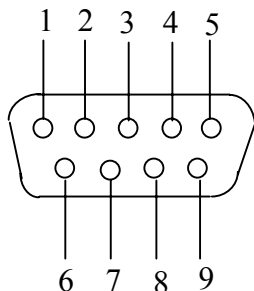

■ The pin assignment of the 9-pin D-SUB connector

Digital Video Recorder			HOST	
PIN #	NAME		PIN #	NAME
1	NOT CONNECTED		1	NOT CONNECTED
2	TXD	→	2	RXD
3	RXD	←	3	TXD
4	NOT CONNECTED		4	NOT CONNECTED
5	GROUND	—	5	GROUND
6	NOT CONNECTED		6	NOT CONNECTED
7	NOT CONNECTED		7	NOT CONNECTED
8	NOT CONNECTED		8	NOT CONNECTED
9	NOT CONNECTED		9	NOT CONNECTED

10.1 Transmission setting

There are 6 different speeds that can be used to transmit instruction or information through the RS232/RS485 port on the device, 1200 baud,2400 baud,4800 baud,9600 baud, 19200 baud,and 3840 baud.

The default setting from the factory is 9600 baud.

Please refer to Chart 6.11 (page27) for details.

2-4. Opcode Byte & Data bytes

2-4-1. OPcode

OPcode	Data1	Function
0x4B	Keycode	A remote key pressed

2-4-1. A remote key pressed (OPcode=0x4B)

Data1	Key
0x00	key 'LEFT'
0x01	key 'RIGHT'
0x02	key 'UP'
0x03	key 'DOWN'
0x04	key 'ENTER'
0x05	key 'BUZZER'
0x06	key 'LOCK'
0x07	key 'MENU'
0x08	key 'REC'
0x09	key 'REV.PLAY'
0x0A	key 'STOP'
0x0B	key 'PLAY'
0x0C	key 'PAUSE'
0x0D	key 'SEARCH'
0x0E	key 'COPY'
0x0F	key 'DISPALY'
0x10	key 'SHUTTLE << x2"
0x11	key 'SHUTTLE << x4"
0x12	key 'SHUTTLE << x6"
0x13	key 'SHUTTLE << x8"
0x14	key 'SHUTTLE << x16"
0x15	key 'SHUTTLE << x32"
0x16	key 'SHUTTLE << x600"
0x17	key 'SHUTTLE >> x2"
0x18	key 'SHUTTLE >> x4"
0x19	key 'SHUTTLE >> x6"
0x1a	key 'SHUTTLE >> x8"
0x1b	key 'SHUTTLE >> x16"
0x1c	key 'SHUTTLE >> x32"
0x1d	key 'SHUTTLE >> x600"
0x1e	key 'JOG<'
0x1f	key 'JOG>'

2-5. Checksum Byte

Checksum is computed as the sum of all previous byte(including the length byte), then mask with 0x7f.

11. Remote Controller

(Optional)

- The remote controller is an accessory to enhance the handy operations of digital video recorder (Figure 1). You can do all the settings and operations by the remote controller. The effective distance is up to 10 meters without any obstacles. The keypad functions are as same as the front panel of the digital video recorder .

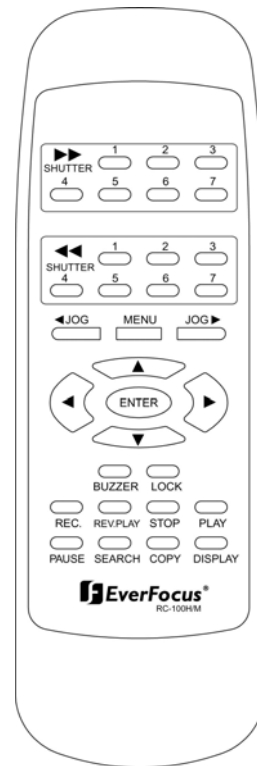

Figure 1

12. APPENDIX- A/Time Lapse Mode Recording Time

12.1 When Recording with an 80-GB HDD

(Estimated with typical image-low noise level)

Lower : 15 kB
 Low : 20 kB
 Basic : 25 kB
 Standard : 30 kB
 High : 35 kB
 Superior : 40 kB

NTSC		(system storage:80GB)					
Recording Speed (Hour)	Recording Rate (field/Sec)	PICTURE QUALITY					
		LOWER	LOW	BASIC	STANDARD	HIGH	SUPERIOR
2	60	24H	18H	14H	12H	10H	9H
6	15	98H	74H	59H	49H	42H	37H
12	8.571	172H	129H	103H	86H	74H	64H
24	4.615	321H	240H	192H	160H	137H	120H
48	2.4	617H	463H	370H	308H	264H	231H
72	1.622	913H	685H	548H	456H	391H	342H
96	1.224	1210H	907H	726H	605H	518H	453H
168	0.706	2098H	1573H	1259H	1049H	899H	786H
480	0.249	5949H	4462H	3569H	2974H	2549H	2231H
720	0.166	8924H	6693H	5354H	4462H	3824H	3346H
960	0.125	11851H	8888H	7111H	5925H	5079H	4444H

PAL		(system storage:80GB)					
Recording Speed (Hour)	Recording Rate (field/Sec)	PICTURE QUALITY					
		LOWER	LOW	BASIC	STANDARD	HIGH	SUPERIOR
3	50	29H	22H	17H	14H	12H	11H
6	16.667	88H	66H	53H	44H	38H	33H
12	10	148H	111H	88H	74H	63H	55H
24	5.556	266H	200H	160H	133H	114H	100H
48	2.941	503H	377H	302H	251H	215H	188H
72	2	740H	555H	444H	370H	317H	277H
96	1.515	977H	733H	586H	488H	419H	366H
168	0.877	1689H	1266H	1013H	844H	724H	633H
480	0.311	4763H	3572H	2858H	2381H	2041H	1786H
720	0.207	7156H	5367H	4294H	3578H	3067H	2683H
960	0.156	9646H	7122H	5698H	4748H	4070H	3561H

Reference:24H=1 day,168H=1 week, 720H=1 month,8760H=1 year

12.2 When Recording with a 160-GB HDD

(Estimated with typical image-low noise level)

Lower : 15 kB
 Low : 20 kB
 Basic : 25 kB
 Standard : 30 kB
 High : 35 kB
 Superior : 40 kB

NTSC		(system storage:160GB)					
Recording Speed (Hour)	Recording Rate (field/Sec)	PICTURE QUALITY					
		LOWER	LOW	BASIC	STANDARD	HIGH	SUPERIOR
2	60	49H	37H	29H	24H	21H	18H
6	15	197H	148H	118H	98H	84H	74H
12	8.571	345H	259H	207H	172H	148H	129H
24	4.615	642H	481H	385H	321H	275H	240H
48	2.4	1234H	925H	740H	617H	529H	463H
72	1.622	1826H	1370H	1096H	913H	782H	685H
72	1.224	2420H	1815H	1452H	1210H	1037H	907H
168	0.706	4196H	3147H	2518H	2098H	1798H	1573H
480	0.249	11899H	8924H	7139H	5949H	5099H	4462H
720	0.166	17849H	13386H	10709H	8924H	7649H	6693H
960	0.125	23703H	17777H	14222H	11851H	10158H	8888H

PAL		(system storage:160GB)					
Recording Speed (Hour)	Recording Rate (field/Sec)	PICTURE QUALITY					
		LOWER	LOW	BASIC	STANDARD	HIGH	SUPERIOR
3	50	59H	44H	35H	29H	25H	22H
6	16.667	177H	133H	106H	88H	76H	66H
12	10	296H	222H	177H	148H	127H	111H
24	5.556	533H	400H	320H	266H	228H	200H
48	2.941	1007H	755H	604H	503H	431H	377H
72	2	1481H	1111H	888H	740H	634H	555H
96	1.515	1955H	1466H	1173H	977H	838H	733H
168	0.877	3378H	2533H	2027H	1689H	1447H	1266H
480	0.311	9527H	7145H	5716H	4763H	4083H	3572H
720	0.207	14313H	10735H	8588H	7156H	6134H	5367H
960	0.156	18993H	14245H	11396H	9496H	8140H	7122H

Reference:24H=1 day,168H=1 week, 720H=1 month,8760H=1 year

13. APPENDIX-B/SECURITY LOCK SETTING



LOCK

**Press LOCK key during record mode, then all the keys on the front panel will be locked.
(Password must be Enable on System Setting Menu)**



LOCK

Press LOCK key, the system will ask for the password. If you enter a correct password, the locked keys will be released.

EverFocus Electronics Corp.

Head Office:

12F, No.79 Sec. 1 Shin-Tai Wu Road,
Hsi-Chi, Taipei, Taiwan

TEL : 886-2-26982334

FAX : 886-2-26982380

USA Office:

2445 Huntington Drive, San Marino,
CA 91108, U.S.A.

TEL : 1-626-844-8888

FAX : 1-626-844-8838

Toll free : 1-888-383-6287 or
1-888-EV-FOCUS

Japan Office:

1809 WBG Marive East 18F,
2-6 Nakase.Mihama-ku.

Chiba city 261-7118, Japan

TEL : 81-43-212-8188

FAX : 81-43-297-0081

Beijing Office:

Room 609, Technology Trade Building,
Shandgd Information Industry Base,

Haidian District, Beijing, China

TEL : 86-10-62971096

FAX : 86-10-62971432

European Office:

Albert-Einstein-Strasse 1

D-46446 Emmerich, German

TEL : 49-2822-9394-0

FAX : 49-2822-939495



EverFocus®

P/N:MSR1G01910

Free Manuals Download Website

<http://myh66.com>

<http://usermanuals.us>

<http://www.somanuals.com>

<http://www.4manuals.cc>

<http://www.manual-lib.com>

<http://www.404manual.com>

<http://www.luxmanual.com>

<http://aubethermostatmanual.com>

Golf course search by state

<http://golfingnear.com>

Email search by domain

<http://emailbydomain.com>

Auto manuals search

<http://auto.somanuals.com>

TV manuals search

<http://tv.somanuals.com>