

Speed Dome

EPTZ900/500

USER MANUAL



Date: June 2006

Table of Contents

1.	EPTZ900/500 OVERVIEW.....	1-3
1.1.	Introduction	1-3
1.2.	Specifications	1-5
1.3.	Feature	1-7
1.3.1.	Profile of EPTZ900/500.....	1-7
1.3.2.	Base Board	1-8
1.3.3.	EPTZ900/500 Control Board	1-9
1.4.	EPTZ900/500 Connection.....	1-10
1.5.	EPTZ900/500 Quick Operation Guide (Work with EKB500)	1-11
2.	EPTZ900/500 INSTALLATION	2-12
2.1.	Packing List	2-12
2.2.	Cable Needed.....	2-12
	Power Cable.....	2-12
	Video Cable.....	2-13
	Control Cable.....	2-13
	Alarm Cable	2-13
2.3.	Initial Setup.....	2-13
2.3.1.	Address Setting.....	2-14
2.3.2.	Communication Protocol Setting.....	2-17
2.3.3.	Transmission Speed Setting (Baud Rate Setting)	2-17
2.3.4.	Video Format Setting	2-18
2.3.5.	RS-485 Bus Terminator Resistance	2-18
2.4.	Rack and Speed Dome Installation	2-20

2.4.1.	Installation Requirements.....	2-20
2.4.2.	EPTZ900 Dome Camera Wall Mount Installation	2-20
2.4.3.	EPTZ500 Dome Camera Installation	2-24
2.5.	Separately Sold Accessories.....	2-27
2.5.1.	Pole mount.....	2-27
2.5.2.	Pole adapter.....	2-27
2.5.3.	Corner mount	2-27
2.5.4.	Multi-Function Keyboard Controller	2-27
3.	EPTZ900/500 CAMERA SETUP MENU.....	3-28
3.1.	Structure of the Setup Menu	3-28
3.1.1.	Camera Setup Menu.....	3-29
4.	EPTZ900/500 FUNCTION SETUP AND OPERATION... 	4-33
4.1.	Manual Control Mode.....	4-33
4.2.	Auto Pan Mode	4-33
4.3.	Position Setting	4-33
4.4.	Tour Mode	4-34
4.5.	Alarm Link to a Position/Tour.....	4-35
4.6.	Other operations	4-35
	APPENDIX B: Protocol	4-37

1. EPTZ900/500 OVERVIEW

1.1. Introduction

EPTZ900/500, an intelligent high-speed dome camera is ready to secure your property with its omni-directional and exact monitoring. An 18X optical and 12X digital zoom combining with a high-performance chip makes captured images clear and vivid. The other powerful camera functions this type of speed dome equips with:

- PAL / NTSC image format suppose.
- Auto and fast focus increases the searching speed and precision.
- Auto Iris adjusts the monitoring image to the best brightness.
- White Balance function makes the shades of color more natural in different light conditions.
- BLC (Backlight Compensation) function makes objects clear in a high illumination background.
- Color / B&W images auto switching to enhance the sensitivity in a low light condition or at night.

Furthermore, the micro control unit enables camera a nimble and exact movement from minimal 0.01°/sec to maximal 360°/sec. It can go to every preset position in 1 second. It also has other advantages such as:

- 192 preset positions are available.
- 16 cruise tours can be set, and each tour contains up to 16 positions.
- Up to 256 speed domes can be supported on a RS485 bus when all speed domes are controlled by multi-function keyboard controller.
- Auto heater and fan to fit all kinds of temperature.
- Provide 4 alarm inputs and 1 alarm output.

All of the features make the intelligent high-speed dome camera works for a wide range and demanding application such as banks, airports, stations, casinos, streets of cities, intelligent buildings, and etc.

1.2. Specifications

Model	EPTZ900	EPTZ500
Pickup Device	1/4" type Sony Super HAD CCD	
Video Format	NTSC or PAL	
Scanning System	NTSC: 525 TV lines, 60 fields/sec PAL: 625 TV lines, 50 fields/sec	
Picture Elements	768 x 494 (NTSC) , 752 x 582 (PAL)	
Horizontal Resolution	480 TVL	
Sensitivity	1.0 Lux/F=1.4	
S/N Ratio (AGC OFF)	Over 50dB	
Electronic Shutter	1/50~1/10,000 (s)	
Digital Slow Shutter	No	
Shutter Selection	No	
Lens Type	18x optical zoom , f=4.1 mm (wide) to 73.8mm (tele) , F1.4 to F3.0	
Zoom Ratio	216x max (18x Optical and 12x Digital Zoom)	
Auto ICR	No	
Black Light Comp.	ON/OFF	
Auto Gain Control	Auto	
White Balance	Auto/Indoor/Outdoor	
Video Output	BNC 1.0Vp-p , 75ohm	
Sync. Mode	Line Lock/Internal Sync	
Power Source	24VAC	
Power Consumption	18W; 70W with heater	18W
Operating Temperature	-40°C~50°C ; -40°F~122°F	0°C~50°C ; 32°F~122°F
Operating Moisture	≤95%	
Communication	RS-485	
Communication Speed	1200/2400/4800/9600bps	
Horizontal Rotation Speed	0.1°/s—360°/s (1-239 grade shift gears)	
Horizontal Rotation Range	360° unlimited rotation	
Tilt Rotation Range	90° pendulum motion	
Auto Flip	Rotates 180° when camera tilts to the vertical position	
Auto Zoom Speed Control	Control speed auto-adjusted according to zoom length changing	
Auto Pan, 2 Points Scanning	Can set freely	
Auto Pan Speed	1—239 grade available	
Dwell Time (2 points)	1—239 second available	
Preset Positions	192 positions	

Running To Position Speed	1 – 239 grade available, 0.1°/s - 360°/s	
Dwell Time At Preset Position	1 – 239 second available	
Tour	16 group	
Tour Point Per Group	16 preset positions	
Fan, Heater (EPTZ900)	Fan & Heater auto starts	No
Position Accuracy	±0.1°	
Alarm	4 in 1 out with tour/position auto triggering	
Proportional Pan Speed	Yes	
Built-in menu for functions	Yes	
Built-in Protocols	Auto, EVF, Plus-D, A-Type, Pelco-D, Pelco-P	
Communication	RS485	
Address editable through DIP switch	Yes	
Speed Dome Address	0-255	
Manual Pan/tilt speed	Pan: 0.1° ~ 180°/s	Tilt: 0.1° ~ 180°/s
Weatherproof Ratings	IP66	Indoor
Dimensions	218.5mm (W) x 267.5mm (H) / 8.6" (W) x 10.5" (H)	208.5mm (W) x 221.6mm (H) / 8.2" (W) x 8.7" (H)
Weight	4.2kg/9.25lbs	2.15kg/4.8lbs
Certifications	CE ; FCC	

1.3. Feature

1.3.1. Profile of EPTZ900/500

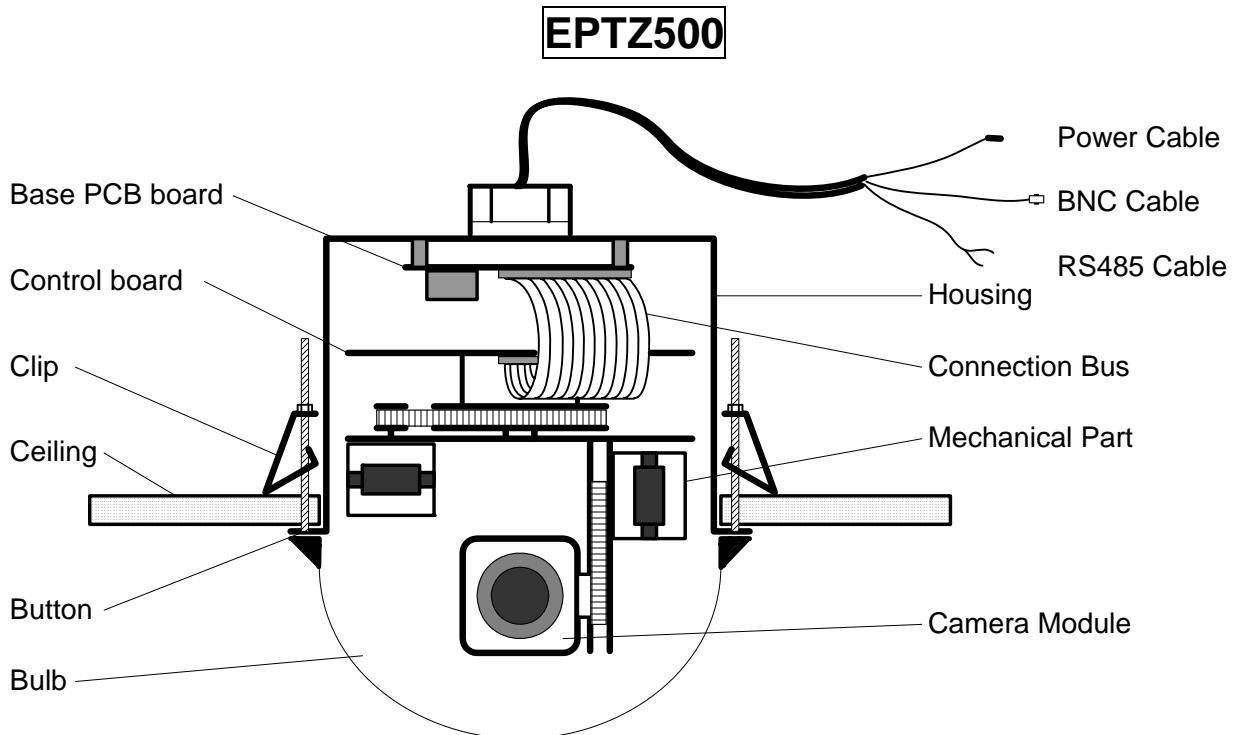
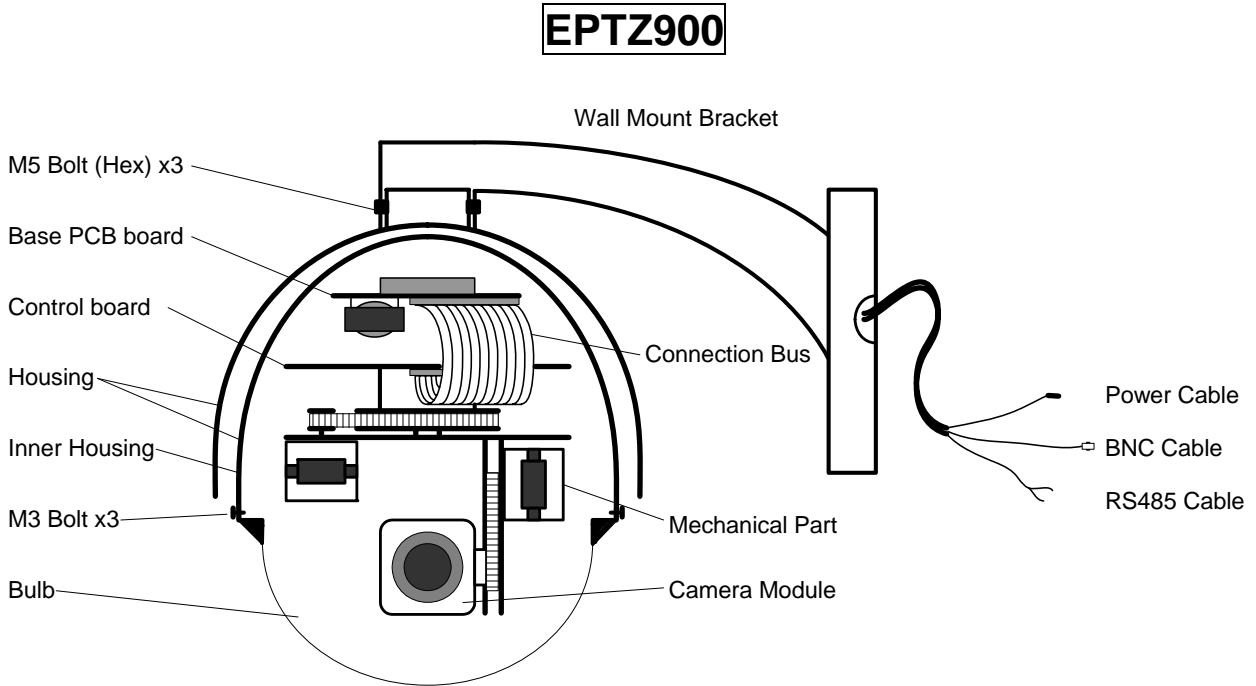

1.3.2. Base Board

The base board that is on the bottom of the housing connects to power cable, video cable, control cable, alarm cable, fan and heater (fan and heater are for EPTZ900 only). In order to connect to cables, the board needs to be taken off, and put back after finishing connecting to all cables. The connectors of cable names are marked on the board in white text. The details of the alarm connector (JP5) are shown on the APPENDIX A.

For EPTZ900, JP1, JP3 and JP6 that are two-pin connectors on the base board need to be taken off during installation. JP1 and JP3 are connectors for heater, and they can be switched. JP6 is a fan controller connector that turns on/off of the fan. The 3 cables are too short to be connected to a wrong connector when putting them back.

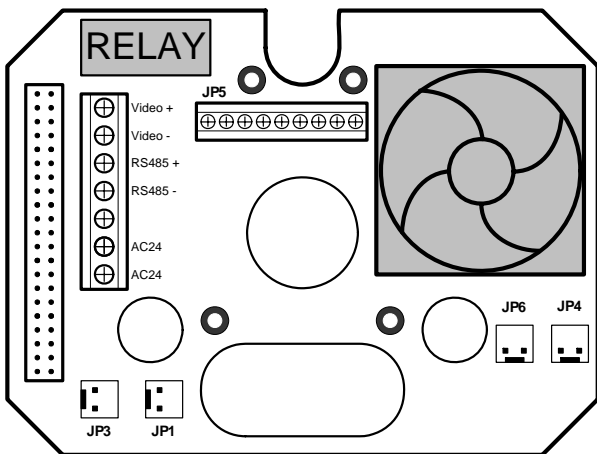

EPTZ900 Baseboard

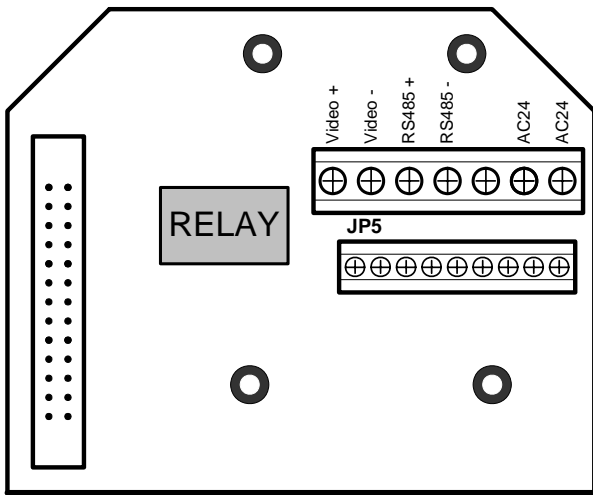

EPTZ500 Baseboard

1.3.3. EPTZ900/500 Control Board

The PCB board with two dipswitches is the control board of speed dome. The two switches are used to set address, protocol, Baud Rate, video format and terminator resistance.

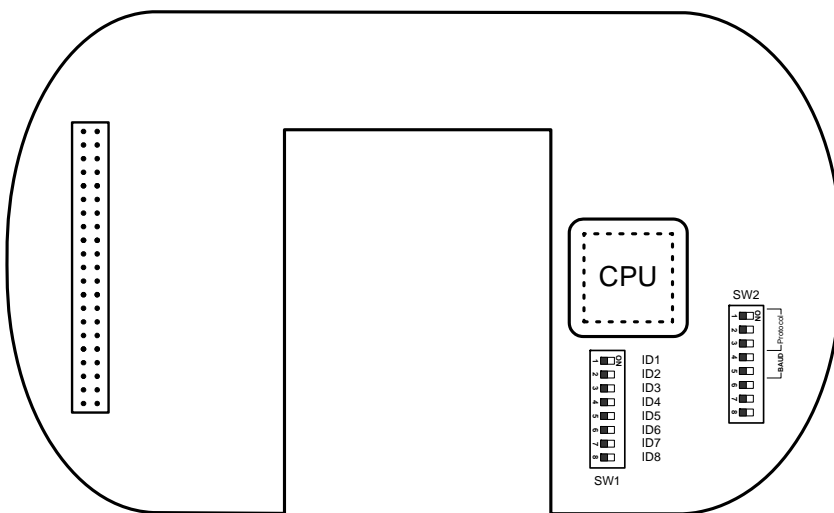

1.4. EPTZ900/500 Connection

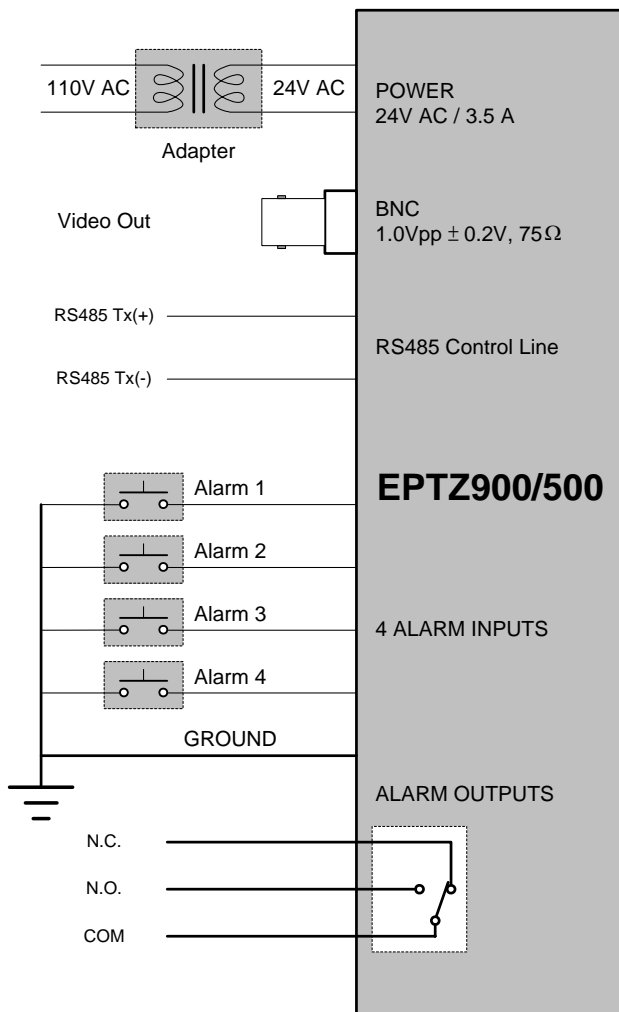

1.5. EPTZ900/500 Quick Operation Guide (Work with EKB500)

EPTZ900/500 and EKB500 (Keyboard) can work together by using factory default setting. You just need to connect cables by following the steps:

1. Connect the RS485 cable to EPTZ900/500 and a Keyboard (EKB500).
2. Connect a video cable from EPTZ900/500 to a monitor.
3. Connect the power to the EPTZ900/500 and a Keyboard (EKB500) .

After the speed dome finishes the self-test mode, you can start to operate the speed dome via the keyboard.

To operate the EPTZ900/500:

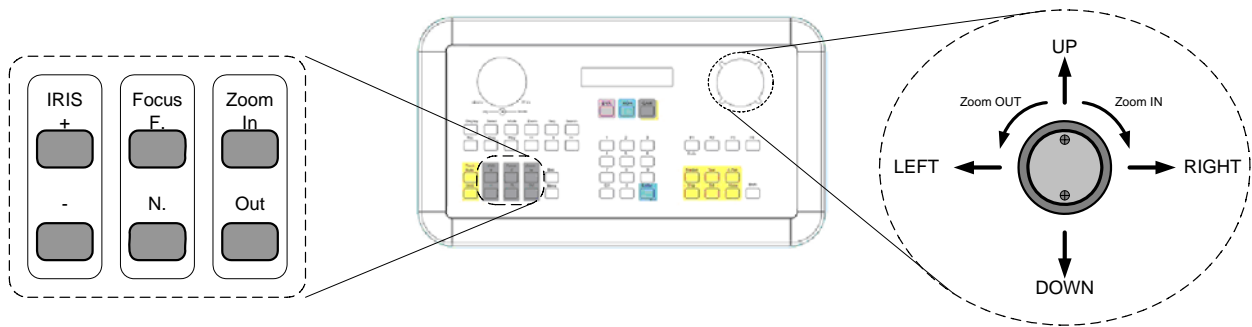

1. Shift the Joystick up/down or right/left to view from camera.
2. Turn the top of the Joystick to zoom in/out.
3. Press Zoom In/Out, Focus F. /N. and IRIS +/- function keys to operate the EPTZ900/500.

2. EPTZ900/500 INSTALLATION

2.1. Packing List

There are 3 boxes that are housing, bulb and mechanical part with a camera module, one wall mount bracket, one power adapter and one accessory packet in the package.

The detail accessories list below:

- Housing x1
- Bulb x1
- Mechanical part with a camera module x1
- Wall mount bracket x1
- Adapter x1
- Accessory packet
 - ✧ Glove x2
 - ✧ M5 Hex Allen wrench x1
 - ✧ Pin connector x1
 - ✧ M5 screw (Hex) x3 for wall mount bracket fixing
 - ✧ M3 screw x3 for bulb fixing
 - ✧ Anchor nut and wall mount screw x4

2.2. Cable Needed

● Power Cable

An adapter with 24V AC/3.5A output provides the power to the speed dome. An extension power line may be needed.

Note: The input AC voltage range of an adapter depends on different area.

Please make sure the voltage range before installing.

- **Video Cable**

A BNC cable is used for connecting a speed dome to a DVR or a monitor. An amplifier may be needed if the video cable is too long.

- **Control Cable**

Basically, EPTZ900/500 uses a differential pair to connect to other devices by cascading. A cable that has low signal decline can be used as a control cable.

- **Alarm Cable**

An alarm cable is not included in the packing list. A suitable wire can be used as an alarm cable.

2.3. Initial Setup

Initial setup includes dome address, communication protocol, transmission speed, video format, and terminator resistance settings. All of the settings should be confirmed before the dome is installed. The control-related setting that is address, communication protocol and transmission speed have to be set consistently with the control device such as a keyboard or a DVR.

Notice: Please make sure the power is off before setting, and restart the speed dome to enable a new value after changing.









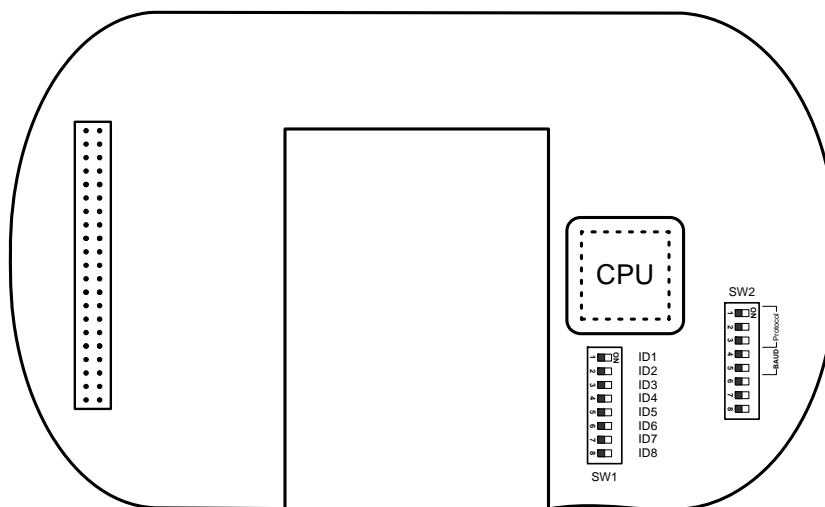











































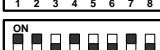











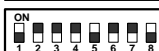

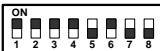
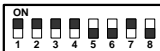
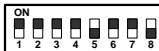

















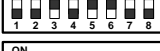





















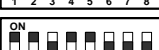
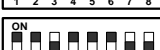









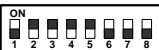

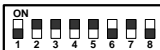
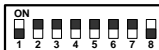
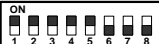
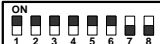
2.3.1. Address Setting

The address code of the EPTZ900/500 should be set to correspond properly with a control device to control multiple dome cameras. The address codes are made up by the dipswitch SW1 (8 bits) on the PCB board. The 8 bits dipswitch indicates the binary coded of the address, and there are 256 addresses can be selected ($0 \sim 255, 2^8 = 256$). It also means that there up to 256 dome cameras can cascade on the RS485 bus. The dipswitch setting and the indicated address are represented in the following chart.

Note: The factory default address is 1.

Notice: Please make sure the power is off before setting, and restart the speed dome to enable a new value after changing.



Switch	Address	Switch	Address	Switch	Address	Switch	Address
	0		32		64		96
	1		33		65		97
	2		34		66		98
	3		35		67		99
	4		36		68		100
	5		37		69		101
	6		38		70		102
	7		39		71		103
	8		40		72		104
	9		41		73		105
	10		42		74		106
	11		43		75		107
	12		44		76		108
	13		45		77		109
	14		46		78		110
	15		47		79		111
	16		48		80		112
	17		49		81		113
	18		50		82		114
	19		51		83		115
	20		52		84		116
	21		53		85		117
	22		54		86		118
	23		55		87		119
	24		56		88		120
	25		57		89		121
	26		58		90		122
	27		59		91		123
	28		60		92		124
	29		61		93		125
	30		62		94		126
	31		63		95		127

Switch	Address	Switch	Address	Switch	Address	Switch	Address
	128		160		192		224
	129		161		193		225
	130		162		194		226
	131		163		195		227
	132		164		196		228
	133		165		197		229
	134		166		198		230
	135		167		199		231
	136		168		200		232
	137		169		201		233
	138		170		202		234
	139		171		203		235
	140		172		204		236
	141		173		205		237
	142		174		206		238
	143		175		207		239
	144		176		208		240
	145		177		209		241
	146		178		210		242
	147		179		211		243
	148		180		212		244
	149		181		213		245
	150		182		214		246
	151		183		215		247
	152		184		216		248
	153		185		217		249
	154		186		218		250
	155		187		219		251
	156		188		220		252
	157		189		221		253
	158		190		222		254
	159		191		223		255

2.3.2. Communication Protocol Setting

The 1st, 2nd and 3rd bits of the SW2 are used to set communication protocol. The factory default protocol is EVF.

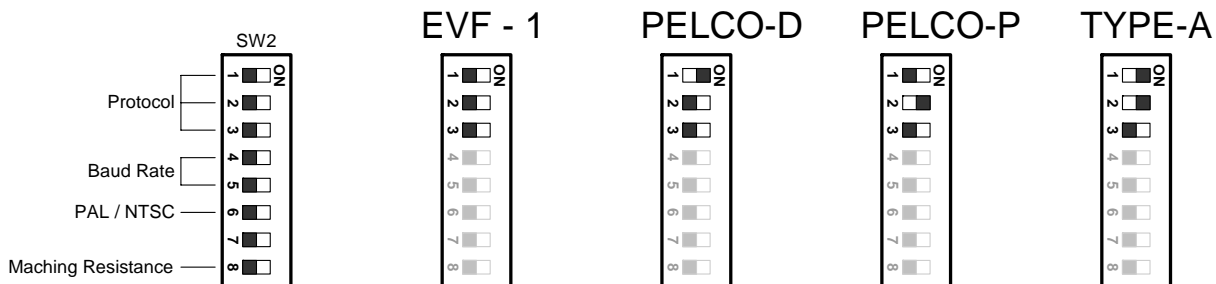

Notice: Please make sure the power is off before setting, and restart the speed dome to enable a new value after changing.

Set all of protocol switches to ON; the EPTZ900/500 will enter a self-test mode.

2.3.3. Transmission Speed Setting (Baud Rate Setting)

The 4th and 5th bits of the SW2 on the PCB board are used to set the Baud Rate. The default baud rate setting is 9600.

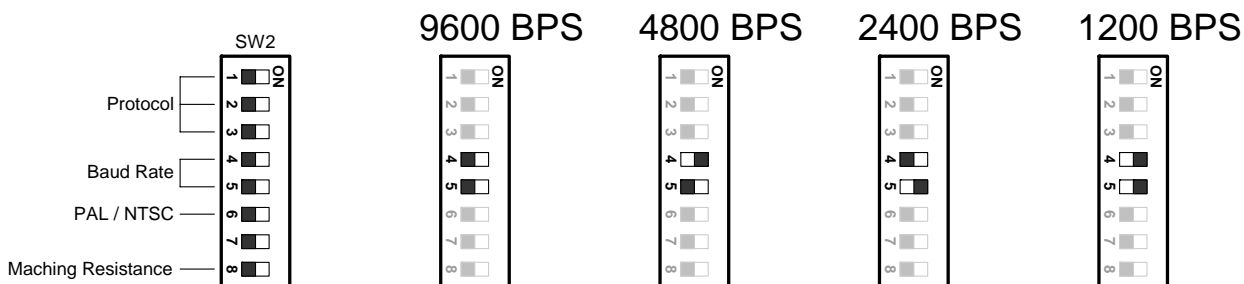

Notice: Please make sure the power is off before setting, and restart the speed dome to enable a new value after changing.

2.3.4. Video Format Setting

The 6th bits of the SW2 on the PCB board are used to set the video format. The default video format depends on the factory setting. Please do not change it.

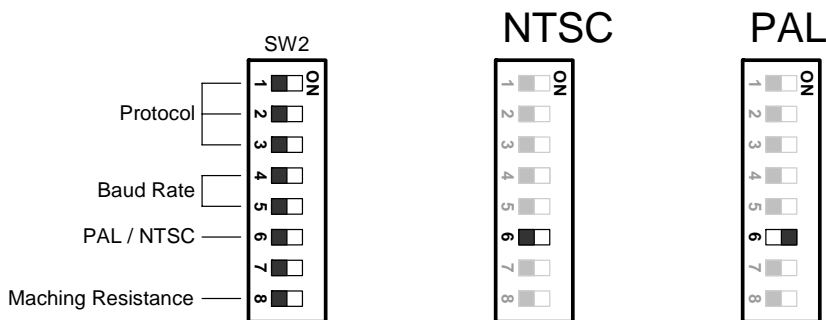

Notice: Please make sure the power is off before setting, and restart the speed dome to enable a new value after changing.

2.3.5. RS-485 Bus Terminator Resistance

For central controlling, the terminator resistance should be set for the device that is the furthest one away from the controller. The 8th bit on the SW2 is a switch to enable or disable the terminator resistance. When it is switched ON, the BUS terminator resistance is connected.



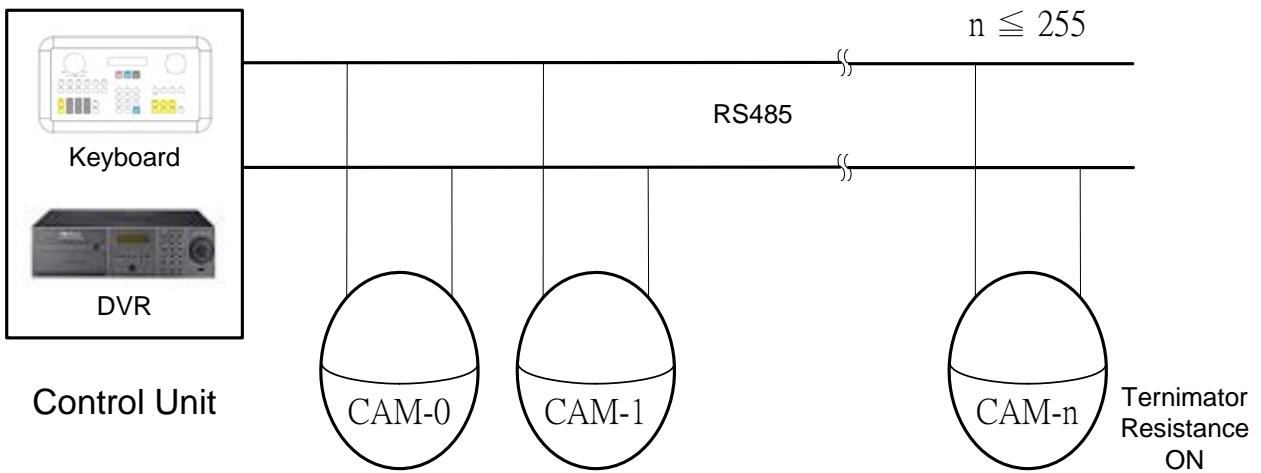

Note: When the dome is out of control, or does not work under control well, try to switch the terminator resistance ON.

Notice: Please make sure the power is off before setting, and restart the speed dome to enable a new value after changing.

2.4. Rack and Speed Dome Installation

2.4.1. Installation Requirements

1. Installation should be handled by a qualified service agent and should comply with all local regulations. Service personnel should expect potential problems such as surface strength, surface material, falling objects, outer breaches, building vibration or other similar conditions.
2. Check for all necessary materials, and ensure if the selected installation location is suitable for the speed dome.

2.4.2. EPTZ900 Dome Camera Wall Mount Installation

Notice: Installation location that is a wall, a pole or a ceiling needs to support above five times the total weight of the camera assembly (about 16 kg) to avoid shaken images, and dropping.

1. Set wall mount bracket on the wall. Mark the center of the holes on the wall against the bracket holes. Use a drill to make 4 holes that can be nailed 4 0.25" X 1.25" screws at the marks.

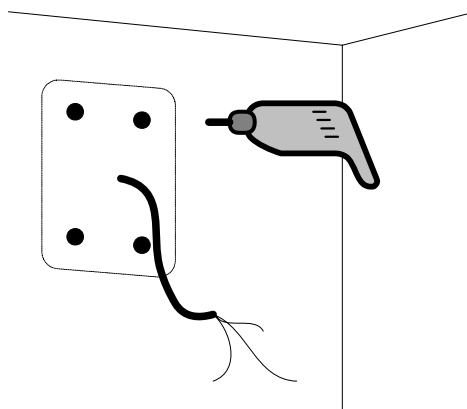

Notice: The length of the screws depends on the surface material. The mentioned screws are used in the normal concrete surface.

2. Thread the cable through the hole in the wall mount bracket, and screw in 4 M8 nuts for mounting the bracket.

3. Take off the housing from the packing, and take off the baseboard (4 bolts on it.) inside the housing. Thread the cable through the top of the housing. Fix the housing on the wall mount bracket, and screw in 3 M5 bolts (Hex) on the top of the bracket with the attached Hex Allen wrench to fix the housing.

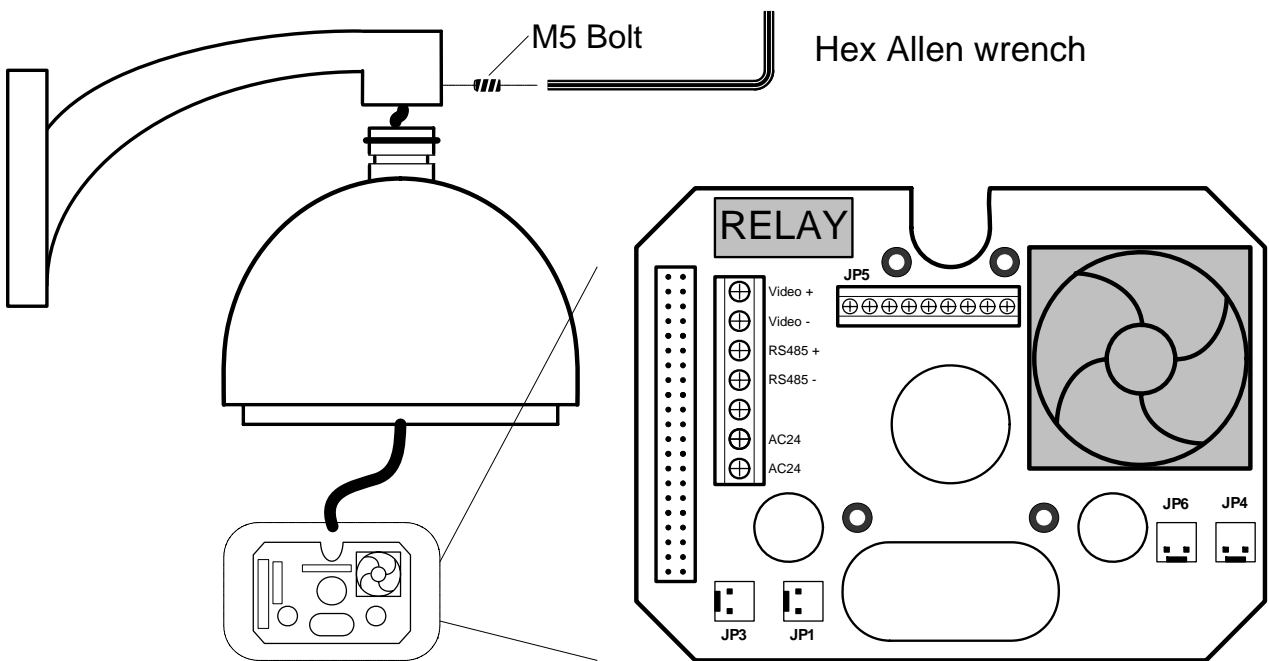

4. Connect the cable connectors to the nodes on the baseboard, and then fix the baseboard in the housing by screwing 4 bolts on it.

Notice: Please notice the polarity of control line. The EPTZ900 will not work if the polarity of control line is mis-connected.

5. Align the two screw holes on the bottom of mechanical part to the two bolts on the base of the housing, and twist the mechanical part clockwise a little bit in order to engage it with the base. Screw the two bolts on the base, and then connect and fix the connection bus to the PCB board on the mechanical part.

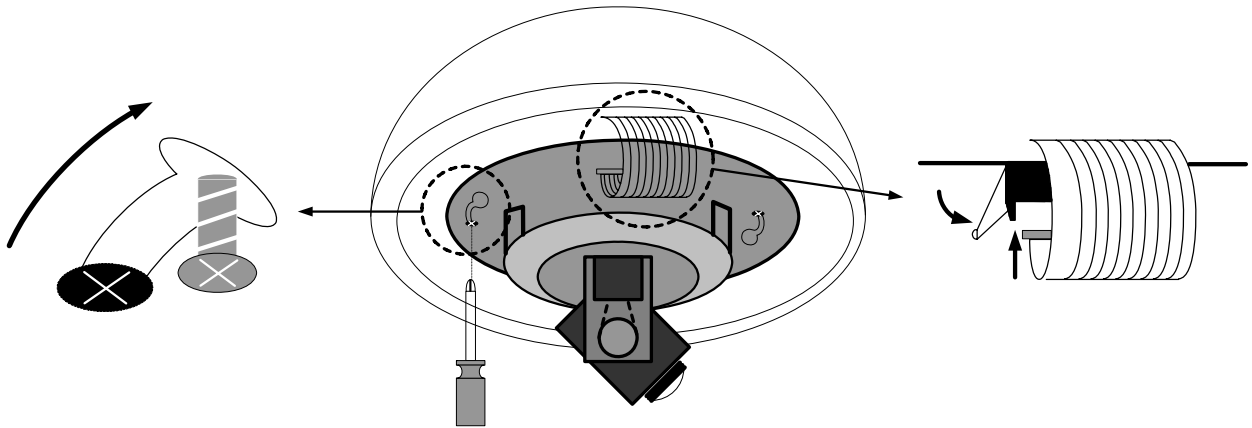

Notice: The camera module on the mechanical part is very sensitive. Please be careful when installing this part.

6. Remove the lens protection cover before installing the bulb. Align the 3 bolt holes into the 3 housing bolt holes, and screw thee M3 bolts with the attached small screw driver to fix the bulb.

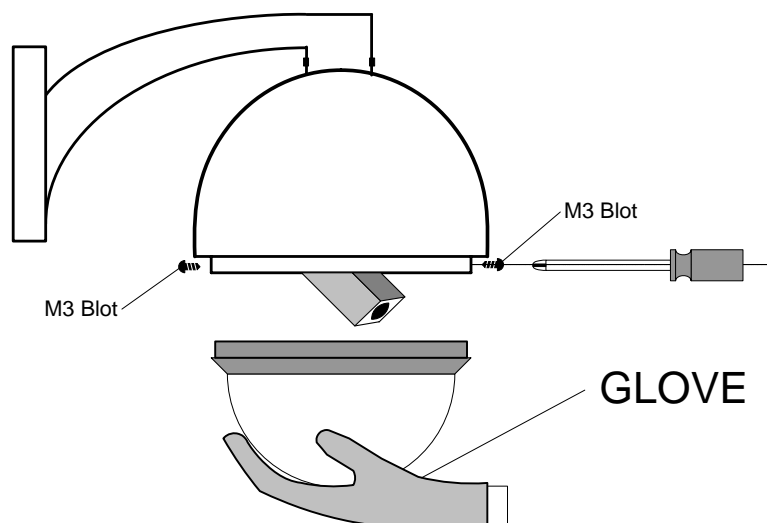

Notice: In order to protect the bulb from dirt and scrape, please put on the gloves before installing the bulb.

7. Turn on the power, and start to operate the EPTZ900.

Note: When turning on the power, the EPTZ900 will enter self-inspection mode, and carry out a self-testing program. After finishing self-inspection, you can start to operate the EPTZ900.

2.4.3. EPTZ500 Dome Camera Installation

1. Take off the housing from the packing, and take off the PCB board (4 bolts on it) inside the housing.
2. Cut the ceiling against the housing's shape with a saw.
3. Thread the cable through the screw and the hole on the top of the housing, and tighten up the screw to fix the cable.
4. Place the housing into the hole that you just made. Fix the housing on the ceiling with two clips, adjust the screws of clips to make the housing perfectly fit to the ceiling.
5. Connect the cable connectors to the nodes on the base board, and then fix the base board in the housing by screwing 4 bolts on it.

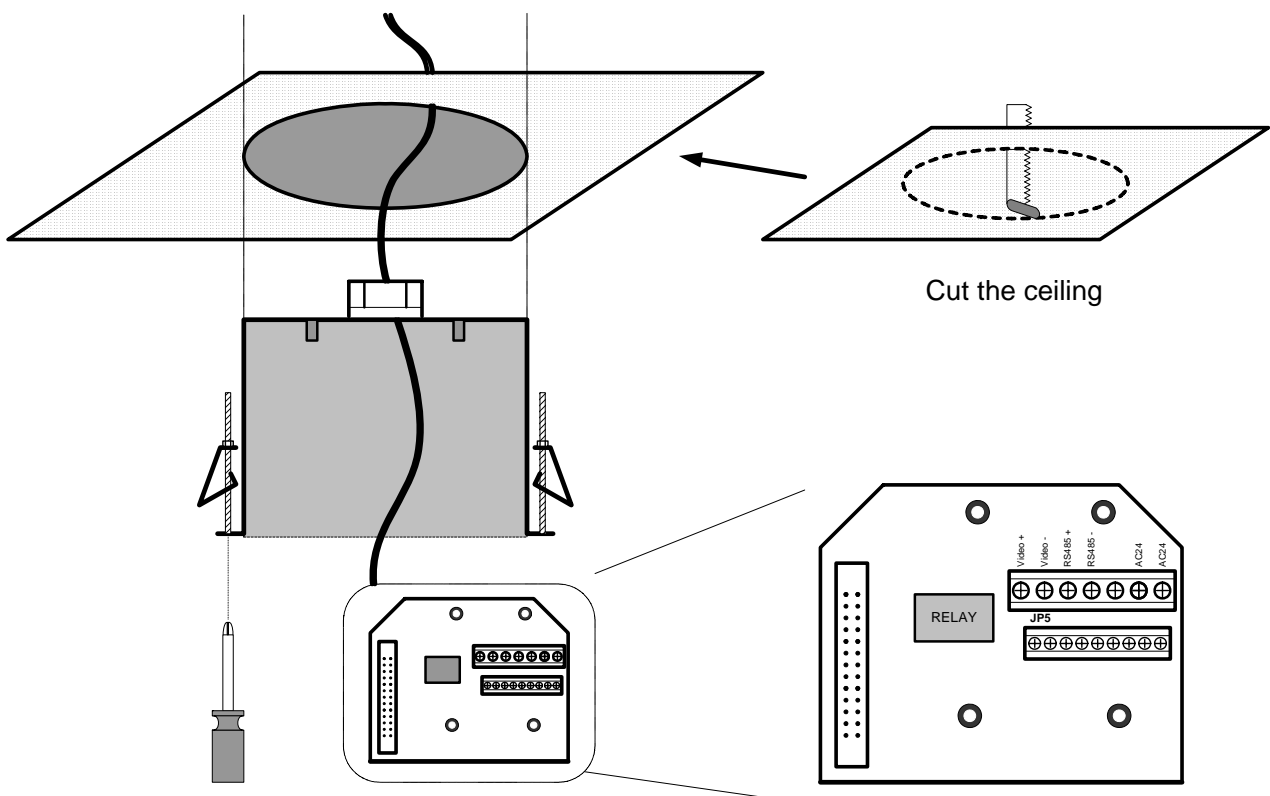

Notice: Please notice the polarity of control line. The EPTZ500 will not work if the polarity of control line is mis-connected.

6. Align the two screw holes on the bottom of mechanical part to the two bolts on the base of the housing, and twist the mechanical part clockwise a little bit in order to engage it with the base. Screw the two bolts on the base, and then connect and fix the connection bus to the PCB board on the mechanical part.

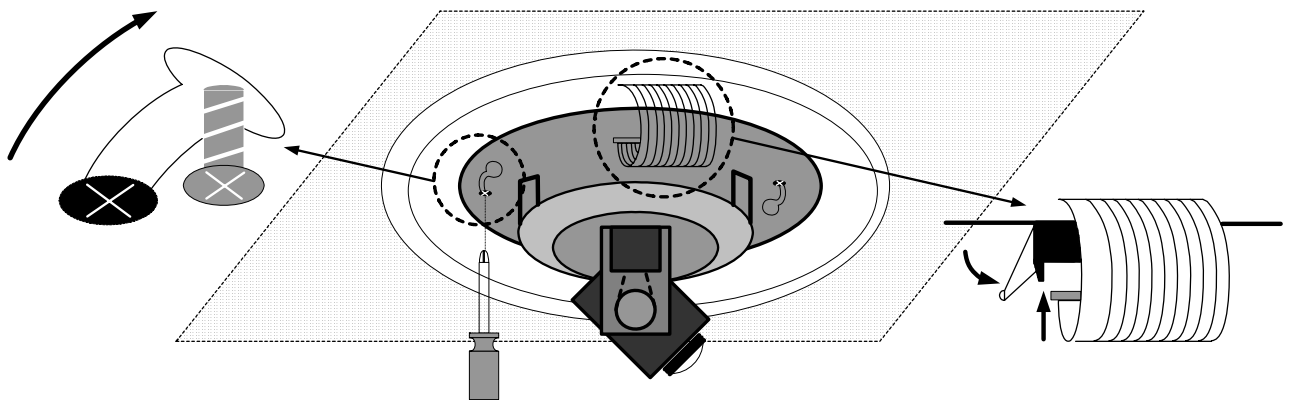

Notice: The camera module on the mechanical part is very sensitive. Please be careful when installing this part.

7. Remove the lens protection cover before installing the bulb. Screw the connection wire to the housing in order to prevent the bulb from being drop down. Align the 2 buttons on the bulb base with the 2 buttons on the housing, and push bulb base to clip the housing.

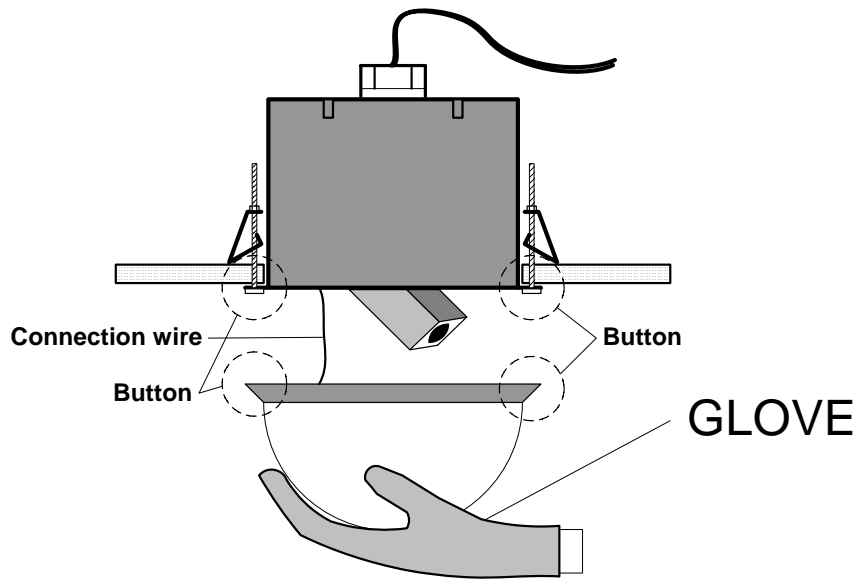

Notice: In order to protect the bulb from dirt and scrape, please put on the gloves before installing the bulb.

8. Turn on the power, and start to operate the EPTZ500.

2.5. Separately Sold Accessories

2.5.1. Pole mount

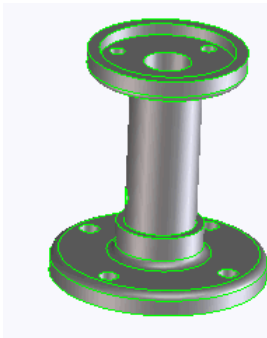

The pole mount is used for installing a speed dome on the ceiling indoors or outdoors.

The extension poles are available for the pole mount.

2.5.2. Pole adapter

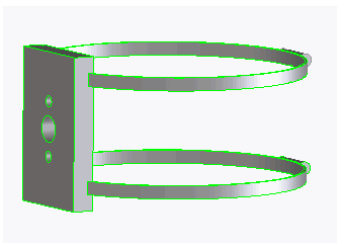

The pole adapter is used for installing a wall mount bracket to a pole indoors or outdoors.

2.5.3. Corner mount

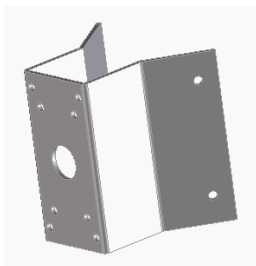

The corner mounts are used for installing a wall mount bracket to a 270° corner of walls indoors or outdoors.

2.5.4. Multi-Function Keyboard Controller



Multi-Function System Controller

Capable of controlling PTZ, DVR and Monitor

3D Joystick control of PTZ function

3. EPTZ900/500 CAMERA SETUP MENU

In this section, setup and operation guide of EPTZ900/500 will be introduced.

There are 22 items of the setting menu. However, there is only one line on the line display, so using some combination keys to operate is necessary.

3.1. Structure of the Setup Menu

Press **MENU** to enter camera setup menu.

Press **Shift** + Joystick up/down to change subentries, and right/left to change the setting.

Items	Option
→ CAM ID	-----
→ DZOOM	OFF / ON
→ FOCUS	AUTO / MAN / ONE PUSH
→ NEGATIVE	OFF / ON
→ COLOR	OFF / ON
→ DISPLAY	OFF / ON
→ BACKLIGHT	OFF / ON
→ WBC MODE	AUTO / INDOOR / OUTDOOR / MAN
→ TITLE DISPLAY	OFF / ON
→ AUTO FLIP	OFF / ON
→ ALM-IN1 SET	N.O. / N.C. / OFF
→ ALM-IN2 SET	N.O. / N.C. / OFF
→ ALM-IN3 SET	N.O. / N.C. / OFF
→ ALM-IN4 SET	N.O. / N.C. / OFF
→ ALM-IN PRIO	1234 / 2341 / 3421 / 4123
→ ALM-OUT	OFF / ON
→ LOAD DEFAULT	-----
→ EXIT MENU	-----

3.1.1. Camera Setup Menu

Press **MENU** to enter camera setup menu.

Press **Shift** + Joystick up/down to change subentries, and right/left to change the setting.

1. CAM ID : The name assigned to the camera.

2. DZOOM : Digital zoom enable or disable.

ON: Enable a digital zoom.

OFF: Disable a digital zoom.

3. FOCUS : Focus type, auto focus and manual focus are available.

AUTO: Auto focus is enabled.

MAN: Manual focus is enabled.

ONE PUSH: Enable the one push trigger focus mode. The focus lens holds the same position until the next trigger command is received. This function prevents the wrong focus in dark.

4. NEGATIVE : Negative image.

ON: Enable a negative image.

OFF: Disable a negative image.

5. COLOR : Color display.

ON: Enable a color display.

OFF: Disable a color display, and show a B&W display.

6. DISPLAY : Display system information and status.

ON: To display the system information and status on the screen.

OFF: Not to display the system information and status on the screen.

7. BACKLIGHT : Backlight compensation.

ON: Enable backlight compensation.

OFF: Disable backlight compensation.

8. WBC MODE : White balance mode.

AUTO: Auto white balance mode.

INDOOR: Indoor white balance mode.

OUTDOOR: Outdoor white balance mode.

MAN: Manual white balance mode.

9. TITLE DISPLAY : Display the title.

ON: Enable title display.

OFF: Disable title display.

10. AUTO FLIP : Flip the camera when it tilts to the 90° end.

ON: Enable auto flip.

OFF: Disable auto flip.

11. ALM-IN1 SET : The status of input alarm 1.

N.O.: Enable a normal open alarm input.

N.C.: Enable a normal close alarm input.

OFF: Disable alarm input.

12. ALM-IN2 SET : The status of input alarm 2.

N.O.: Enable a normal open alarm input.

N.C.: Enable a normal close alarm input.

OFF: Disable alarm input.

13. ALM-IN3 SET : The status of input alarm 3.

N.O.: Enable a normal open alarm input.

N.C.: Enable a normal close alarm input.

OFF: Disable alarm input.

14. ALM-IN4 SET : The status of input alarm 4.

N.O.: Enable a normal open alarm input.

N.C.: Enable a normal close alarm input.

OFF: Disable alarm input.

15. ALM-IN PRIO : The priority of alarms.

1234: The alarm priority is 1>2>3>4.

2341: The alarm priority is 2>3>4>1.

3412: The alarm priority is 3>4>1>2.

4123: The alarm priority is 4>1>2>3.

16. ALM-OUT : Alarm output. There is a built-in relay to offer an alarm output.

ON: Enable alarm output.

OFF: Disable alarm output.

17. LOAD DEFAULT : Load default setting.

Select this item, and then press "Enter" to load default setting.

Press "Clr" + "Menu" whenever you want to quit menu setting.

18. EXIT : To exit.

Select this item, and then press "Enter" to quit setting.

Press "Clr" + "Menu" whenever you want to quit menu setting.

4. EPTZ900/500 FUNCTION SETUP AND OPERATION

4.1. Manual Control Mode

- **Manual control:** Shift Joystick Up/Down/Left/Right, and turn it Clockwise/Counterclockwise to control speed dome.
Use the control keys which are Zoom, Focus and IRIS function keys on the keyboard to zoom In/Out, focus N (near)/F (Far), or IRIS +/-.
- **HOME Mode:** The camera view will go back to the home position when there is no keyboard operation in a specific time. The home position and the specific time can be set by press **Set** + **Home**.

4.2. Auto Pan Mode

- **Two point auto pan:** Press **A.Pan** to enter the auto pan mode, and then the system will ask you to enter the auto pan speed (1~239). Press **Enter** to start auto pan.
In order to set the two points, press **Set** + **A.Pan**, and then enter the dwell time (1~239 seconds) of each point.
- **360° auto pan:** Press **Shift** + **A.Pan** to enter the 360° auto pan. The camera will turn 360° automatically, but not tilt.

4.3. Position Setting

- **Focus on a preset position:** Press the number key, and then press **Position** to focus on the number of preset position; or you can press **Position**, then enter the preset position number, and then press **Enter** to focus on the number of preset position.

- **Preset a position:** Shift the Joystick to the position you would like to preset, and then press **Shift** + **Position**. The system will ask you to enter the preset position number (1~239), and then press **Enter** to save the position. There are up to 192 positions can be preset.
- **Set the parameter of a preset position:** Press **Set** + **Position** to set the parameter of a preset position. You can set the going-to speed (1~239), dwell time (1~239 seconds), and the title of the position. Shift the joystick Right/Left to change bits, and shift the Joystick Up/Down to change the alphanumeric characteristic. The available alphanumeric characteristics are 0~9, A~Z, &, ?, !, :, ', ., ,, /, -, and a space.
- **Delete a preset position:** Press **Clr** + **Position** to delete a preset position. The system will ask you to enter the position number that you would like to delete, and then press **Enter**.

4.4. Tour Mode

In the tour mode, you can set a tour for viewing. There are 16 tours can be set, and 16 preset positions in a tour.

- **One-way tour Mode:** Press **Tour** to enter the tour mode. The system will ask you to enter the tour number you would like to run, and starts the tour after pressing **Enter**. To preset a tour before running it is necessary.
Preset a one-way tour: Press **Set** + **Tour** to preset a one-way tour. The system will ask you to enter preset position numbers (The positions need to be preset). After finish entering all positions, press **Stop** to quit, and then press **Enter** to save the tour.
- **To-and-fro tour mode:** Press **Shift** + **Tour** to run a to-and-fro tour. The system will

ask you to enter the tour number you would like to run, and starts the tour after pressing **Enter**. To preset a tour before running it is necessary.

Note: The difference between the One-way tour mode and To-and-fro tour mode is their return modes. For example: There is a tour with 3 preset positions 1, 2 and 3. The camera runs 1→2→3→1→2→3 in the One-way tour mode, and 1→2→3→2→1 in the To-and-fro tour mode.

4.5. Alarm Link to a Position/Tour

The EPTZ900/500 has 4 alarm inputs that can be set to link to a position or a tour when an alarm is triggered.

➤ **Set an alarm link:**

Press **F1** to set an alarm link. Enter the alarm number, and then press **Enter**.

Switch the Joystick up/down to select a position or a tour, enter a position or tour number, and then press **Enter** to confirm the alarm link setting.

➤ **Delete an alarm link:**

Press **Clr** + **F1** to delete a link of alarm to position/tour.

4.6. Other operations

The EPTZ900/500 can work with a DVR that has PTZ control functions, and a matching protocol. The available control functions depend on different DVRs.

The EPTZ900/500 can work with a keyboard that has PTZ control functions, and a matching protocol. The available control functions depend on different keyboards.

APPENDIX A: The Alarm I/O Connection

There are 4 alarm inputs and 1 alarm output available. The alarm I/O connector that is marked as **JP5** is a nine-pin connector. It is located on the PCB board of the housing.

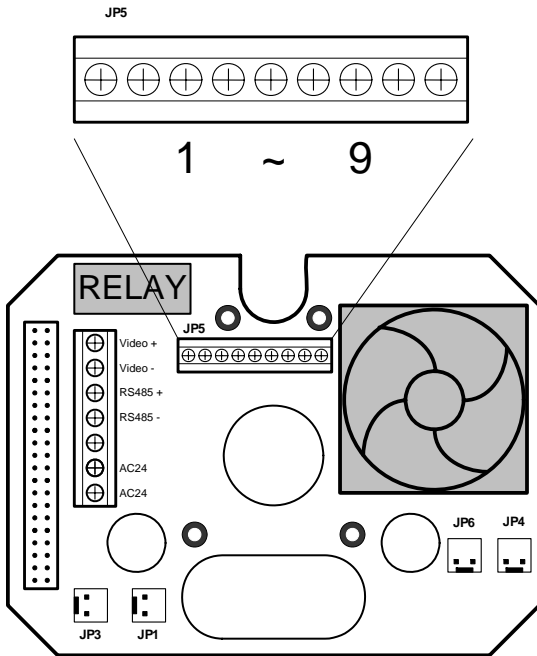

EPTZ900 base board

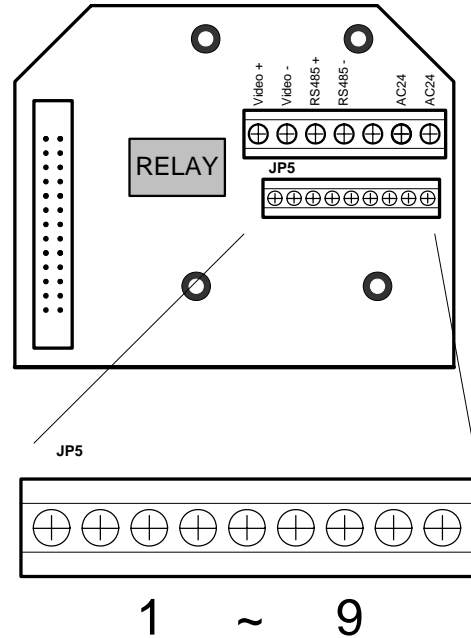

EPTZ500 base board

Pin #	Function
1	Alarm Input 4
2	Ground
3	Alarm Input 3
4	Alarm Input 2
5	Ground
6	Alarm Input 1
7	Normal Open (N.O.)
8	Common (COM)
9	Normal Close (N.C.)

APPENDIX B: Protocol

Speed Dome Control Protocol

1-1. Format

A. Fixed 7 bytes packet

Byte1 (cmd1 = 0xFA)
Byte2 (cmd2)
Byte3 (ID high byte)
Byte4 (ID low byte)
Byte5 (data1)
Byte6 (Keyboard-ID)
Byte7 (checksum)

B. Fixed 8 bytes packet

Byte1 (cmd1 = 0xFC)
Byte2 (cmd2)
Byte3 (ID high byte)
Byte4 (ID low byte)
Byte5 (data1)
Byte6 (Keyboard-ID)
Byte7 (data2)
Byte8 (checksum)

1-2. checksum calculation

1. Address = IDH*32 + IDL
2. Movement Speed: 01-EF ==> begin speed value (01:Slow, EF:Fast)
00 ==> stop
3. checksum ==> $B7=(B1+B2+B3+B4+B5+B6)\&0x7f$

2-1. Part-I

	(B1)	(B2)	(B3)	(B4)	(B5)	(B6)	(B7)	
FUNCTION	CMD1	CMD2	IDH	IDL	DATA1	KB-ID	CSUM	DESCRIPTION
Up	FA	01	00-1F	00-1F	speed	00-5F	cs	speed=00-EFh
Down	FA	02	.	.	speed	.	cs	l
Left	FA	03	.	.	speed	.	cs	l
Right	FA	04	.	.	speed	.	cs	l
Left-up	FA	05	.	.	speed	.	cs	l
Left-down	FA	06	.	.	speed	.	cs	l
Broadcase	FA	09-0E	20	00	grade	.	cs	l
Location A	FA	0F	.	.	WaitT	.	cs	WaitT=0-EFh (second)
Location B	FA	13	.	.	WaitT	.	cs	l
Line Scanning Startup	FA	10	.	.	speed	.	cs	speed =01-EFh
Right-up	FA	07	.	.	speed	.	cs	l
Right-down	FA	08	.	.	speed	.	cs	l
Broadcase	FA	01-08	20	00	speed	.	cs	l
Iris Open	FA	09	.	.	grade	.	cs	grade=00-EFh
Iris Close	FA	0A	.	.	grade	.	cs	l
Zoom Tele	FA	0B	.	.	grade	.	cs	l
Zoom Wide	FA	0C	.	.	grade	.	cs	l
Focus Far	FA	0D	.	.	grade	.	cs	l
Focus Near	FA	0E	.	.	grade	.	cs	l
Surface scan Startup	FA	11	.	.	speed	.	cs	l
startup cruise group	FA	71	.	.	group	.	cs	group=1-16
startup intercruiseScan	FA	72	.	.	group	.	cs	l
Set Preset pos	FA	75	.	.	pp	.	cs	pp=1-192 (position)
To Preset pos	FA	76	.	.	pp	.	cs	l
cruise set start	FA	77	.	.	group	.	cs	group=1-16
adding cruise point	FA	78	.	.	pp	.	cs	pp=1-192 (position)
cruise set close	FA	79	.	.	AA	.	cs	l

Set Single Point Alarm Linkage	FA	7A-7D	.	.	pp	.	cs		pp=1-192 (position)
Clr Single Point Alarm Linkage	FA	7E-81	.	.	AA	.	cs		
Cruise Alarm Linkage Set	FA	82-85	.	.	group	.	cs		group=1-16
Cruise Alarm Linkage Cancel	FA	86-89	.	.	AA	.	cs		
set preset position parameter	FA	A0	.	.	pp	.	cs		pp=1-192 (position)
speed to preset position	FA	A1	.	.	speed	.	cs		speed=1-EFh
Dwell time at preset position	FA	A2	.	.	dwell	.	cs		dwell=1-EFh (seconds)
Set PresetPosition Param Close	FA	A3	.	.	AA	.	cs		
Home Position Set	FA	A4	.	.	AA	.	cs		
Wait time at Home Position	FA	A5	.	.	WaitT	.	cs		WaitT=0-EFh (minutes)
Enable Home position On/Close	FA	A6	.	.	on-off	.	cs		on-off=0/1 (0=off, 1=on)
Clear Preset Position	FA	A7	.	.	pp	.	cs		pp=1-192 (position)
Speed Dome Setup Menu	FA	90	.	.	operate	.	cs		operate=01 Enter menu mode
									=02 Exit menu mode
									=03 menu cursor up
									=04 menu cursor down
									=05 menu cursor left
									=06 menu cursor right
									=07 select option
									=08 confirm

2-2. Part-II (Enhance part)

FUNCTION	(B1)	(B2)	(B3)	(B4)	(B5)	(B6)	(B7)	(B8)	DESCRIPTION
	CMD1	CMD2	IDH	IDL	DATA1	KB-ID	DATA2	CSUM	
enhance move	FC	OP	.	.	x-spd	.	y-spd	cs	OP: (0-3)
									bit0: (0=right, 1=left)
									bit1: (0=up, 1=down)
									x-spd=0-EFh
									y-spd=0-EFh

```

-----+-----
set preset position title | FC 05 . . x-coor . char cs | x-coor=0-19
| | | | | | | | | |
| | | | | | | | | |
| | | | | | | | | |
| | | | | | | | | |
| | | | | | | | | |
| | | | | | | | | |
| | | | | | | | | |
clean preset position title | FC 0A . . PP . 00 cs | PP=1-192
-----+-----
Remote reboot | FC 0C . . 55 . AA 08 |
| | | | | | | | | |

```

EverFocus Electronics Corp.

Head Office:

12F, No.79 Sec. 1 Shin-Tai Wu Road,

Hsi-Chih, Taipei, Taiwan

TEL: +886-2-26982334

FAX: +886-2-26982380

www.everfocus.com.tw

China Office:

Room 609, Technology Trade Building,

Shandgdi Information Industry Base,

Haidian District, Beijing, China

TEL: +86-10-62971096

FAX: +86-10-62971432

www.everfocus.com.cn

USA Office:

1801 Highland Ave. Unit A

Duarte, CA 91010, U.S.A.

TEL: +1-626-844-8888

FAX: +1-626-844-8838

www.everfocus.com

Japan Office:

1809 WBG MARIBU East 18F,

2-6 Nakase.Mihama-ku.

Chiba city 261-7118, Japan

TEL : +81-43-212-8188

FAX : +81-43-297-0081

www.everfocus.com

European Office:

Albert-Einstein-Strasse 1

D-46446 Emmerich, Germany

TEL: 49-2822-9394-0

FAX: 49-2822939495

www.everfocus.de

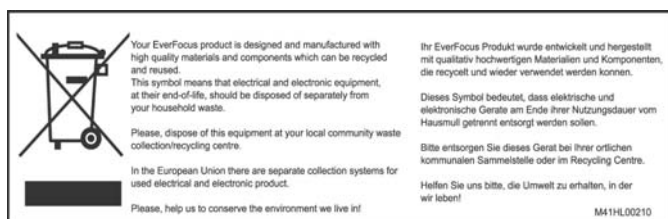

P/N : MW01G00900

Free Manuals Download Website

<http://myh66.com>

<http://usermanuals.us>

<http://www.somanuals.com>

<http://www.4manuals.cc>

<http://www.manual-lib.com>

<http://www.404manual.com>

<http://www.luxmanual.com>

<http://aubethermostatmanual.com>

Golf course search by state

<http://golfingnear.com>

Email search by domain

<http://emailbydomain.com>

Auto manuals search

<http://auto.somanuals.com>

TV manuals search

<http://tv.somanuals.com>