

EVGA®

Intelligent Innovation

EVGA
X58
SLI Micro

Gaming

Imaging

3D

Video

Entertainment

Photos

Graphics

EVGA X58 SLI Micro
Motherboard

User's Manual

Table of Contents

User's Guide	1
EVGA X58 SLI Micro Motherboard	1
Before You Begin...	8
Parts NOT in the Kit	8
Intentions of the Kit	8
EVGA X58 SLI Micro Motherboard	10
Motherboard Specifications.....	10
Unpacking and Parts Descriptions.....	12
Unpacking	12
Equipment.....	12
EVGA X58 SLI Micro Motherboard	13
Hardware Installation	16
Safety Instructions.....	16
Preparing the Motherboard	17
Installing the CPU	17
Installing the CPU Fan	18
Installing System Memory (DIMMs).....	19
Installing the Motherboard.....	20
Installing the I/O Shield	20
Securing the Motherboard into a System Case	21
Connecting Cables.....	21
24-pin ATX Power (PW1).....	22

8-pin ATX 12V Power (PW12)	23
Connecting Serial ATA Cables.....	23
Connecting Internal Headers	24
Front Panel Header	24
IEEE1394a (Firewire).....	25
USB Headers	26
Audio	27
Fan Connections	28
Expansion Slots	29
PCI Slots	30
PCI Express x1 Slots	30
PCI Express x16/x8/x4 Slots.....	30
Onboard Buttons	31
Clear CMOS Button	31
RESET and POWER Button	31
Post Port Debug LED and LED Status Indicators.....	32
Post Port Debug LED	32
LED Status Indicators	32
Configuring the BIOS	33
Enter BIOS Setup.....	34
Main Menu.....	34
Standard CMOS Features Menu	37
Date and Time.....	38
SATA Channel.....	38
Halt On	41
Memory	41
Advanced BIOS Features	42

Hard Disk Boot Priority	43
CD-ROM Device Priority	43
First/Second/Third Boot Device	43
Boot Other Device	44
Boot Up NumLock Status	44
Security Option.....	44
Integrated Peripherals Menu.....	45
Onboard PATA/SATA Device	46
Onboard Device	46
USB Device Settings	47
Power Management Setup Menu	49
ACPI Function	49
ACPI Suspend Type.....	50
Run VGABIOS if S3 Resume.....	50
Soft-Off by PWR-BTTN	50
Wake-Up by PCI Card.....	50
USB KB Wake-Up From S3	50
Resume by Alarm.....	50
POWER ON Function	51
Hot Key Power On	51
PWRON after PWR-Fail.....	51
PnP/PCI Configuration Menu	52
Init Display First.....	52
Reset Configuration	53
Resources Controlled By	53
IRQ Resources.....	53
PCI/VGA Palette Snoop	54

INT Pin 1/2/3/4/5/6/7/8 Assignment	54
Maximum Payload Size.....	54
PC Health Status Menu.....	55
SmartFan Function.....	56
Frequency/Voltage Control Menu	57
Memory Feature	58
Voltage Control.....	60
CPU Feature	61
Installing Drivers and Software	64
Windows XP/Vista Driver Installation	64
Appendix A. POST Codes for the EVGA X58 SLI Micro Motherboard	65

List of Figures

Figure 1.	EVGA X58 SLI Micro Motherboard Layout	14
Figure 2.	Chassis Backpanel Connectors	15
Figure 3.	PWR1 Motherboard Connector	22
Figure 4.	BIOS CMOS Setup Utility Main Menu	35
Figure 5.	Standard CMOS Features Menu	37
Figure 6.	Advanced BIOS Features Menu	42
Figure 7.	Integrated Peripherals Menu	45
Figure 8.	Power Management Setup Menu	49
Figure 9.	PnP/PCI Configuration Menu	52
Figure 10.	PC Health Status Menu	55
Figure 11.	Frequency/Voltage Control	57
Figure 12.	Memory Feature Menu	58
Figure 13.	Voltage Control Menu	60
Figure 14.	CPU Feature Menu	62

Before You Begin...

Parts NOT in the Kit

This kit contains all the hardware necessary to install and connect your new EVGA X58 SLI Micro Motherboard. However, it does not contain the following items that must be purchased separately to make the motherboard functional.

- ❑ **Intel Microprocessor**
- ❑ **System Memory**
- ❑ **Cooling fan for the Microprocessor**
- ❑ **Graphics Card**
- ❑ **Power Supply**

EVGA assumes you have purchased all the necessary parts needed to allow for proper system functionality.

Intentions of the Kit

This kit provides you with the motherboard and all connecting cables necessary to install the motherboard into a system case. If you are *building* a PC, you will use most of the cables provided in the kit. If however, you are *replacing* a motherboard, you will not need many of the cables.

When *replacing* a motherboard in a system case, you will need to reinstall an operating system even though the current Hard Disk Drive may already have an operating system.

EVGA X58 SLI Micro Motherboard

Thank you for purchasing the EVGA X58 SLI Micro Motherboard. This motherboard offers enthusiast performance and when combined with two SLI-Ready NVIDIA® GeForce® graphics cards, you get innovative NVIDIA® SLI® technology for enhanced system performance.

Motherboard Specifications

- ❑ Size:
MATX form factor of 9.6 inch x 9.6 inch
- ❑ Microprocessor support:
Intel Core i7 processor
- ❑ Operating systems:
Supports Windows XP 32bit/64bit and Windows Vista 32bit/64bit
- ❑ Contains INTEL X58 and ICH10R chipset
- ❑ System Memory support:
Supports triple channel JEDEC DDR3-1600. Officially supports up to 24GBs of DDR3 memory.
- ❑ USB 2.0 Ports:
Supports hot plug
Twelve USB 2.0 ports (Eight rear panel ports, four onboard USB headers)
Supports wake-up from S1 and S3 mode
Supports USB 2.0 protocol up to a 480 Mbps transmission rate

- ❑ Six(6) onboard Serial ATA II
 - 300MBps data transfer rate
 - Six Serial ATA II connectors from south bridge with support for RAID 0, RAID 1, RAID 10, and RAID 5
 - Supports hot plug and NCQ (Native Command Queuing)
- ❑ Onboard LAN
 - Integrated LAN port
 - Supports 10/100/1000 Mbit/sec Ethernet
- ❑ Onboard IEEE1394a (Firewire)
 - Support hot plug
 - Two IEEE1394a ports (two onboard headers) with a rate transmission of 400 Mbps
- ❑ Onboard Audio
 - Realtek High-Definition audio
 - Supports 8-channel audio
 - Supports S/PDIF output (Optical and COAX)
 - Supports Jack-Sensing function
- ❑ PCI Express Support
 - Two (2) PCI-E 2.0 Slots
 - Supports up to 4 GB/sec (8 GB/sec concurrent) bandwidth
 - Low power consumption and power management features
- ❑ Green Function
 - Supports ACPI (Advanced Configuration and Power Interface)
 - Supports S0 (normal), S1 (power on suspend), S3 (suspend to RAM), S4 (Suspend to disk - depends on OS), and S5 (soft - off)
- ❑ Expansion Slots
 - One PCI slot
 - One PCI Express x1 slot
 - Two PCI Express x4/x8/x16 slots

Unpacking and Parts Descriptions

Unpacking

The EVGA X58 SLI Micro Motherboard comes with all the necessary cables for adding a motherboard to a system case. If replacing a motherboard, you may not need many of these cables.

All parts shipped in this kit are RoHS-compliant (lead-free) parts.

Equipment

The following accessories are included with the EVGA X58 SLI Micro Motherboard.



The EVGA X58 SLI Micro Motherboard

This PCI Express motherboard contains the Intel X58 and ICH10R chipset and is SLI-ready for both 2-Way and 3-Way SLI configurations.



1 - Visual Guide

Helps to quickly and visually guide you through the hardware installation of the motherboard.



1 - I/O Shield

Installs in the system case to block radio frequency transmissions, protect internal components from dust, foreign objects, and aids in proper airflow within the chassis.



1 - 2-Port SATA Power Cables

Allows a Molex power connector to adapt to a SATA power connector.



2 - SATA Data Cables

Used to support the Serial ATA protocol and each one connects a single drive to the motherboard.



1 - 2-Port USB and 1-Port 1394 bracket

Provides one (1) additional IEEE1394a port to the back panel of the chassis and provides two additional USB ports to the back panel.



1 - 2-Way SLI Bridge

Bridges two (2) graphic cards together which allows for 2-Way SLI.



1 - Installation CD

Contains drivers and software needed to setup the motherboard.

EVGA X58 SLI Micro Motherboard

The EVGA X58 SLI Micro Motherboard with the Intel X58 and ICH10R chipset is a PCI Express, SLI-ready motherboard. Figure 1 shows the motherboard and Figures 2 shows the back panel connectors.

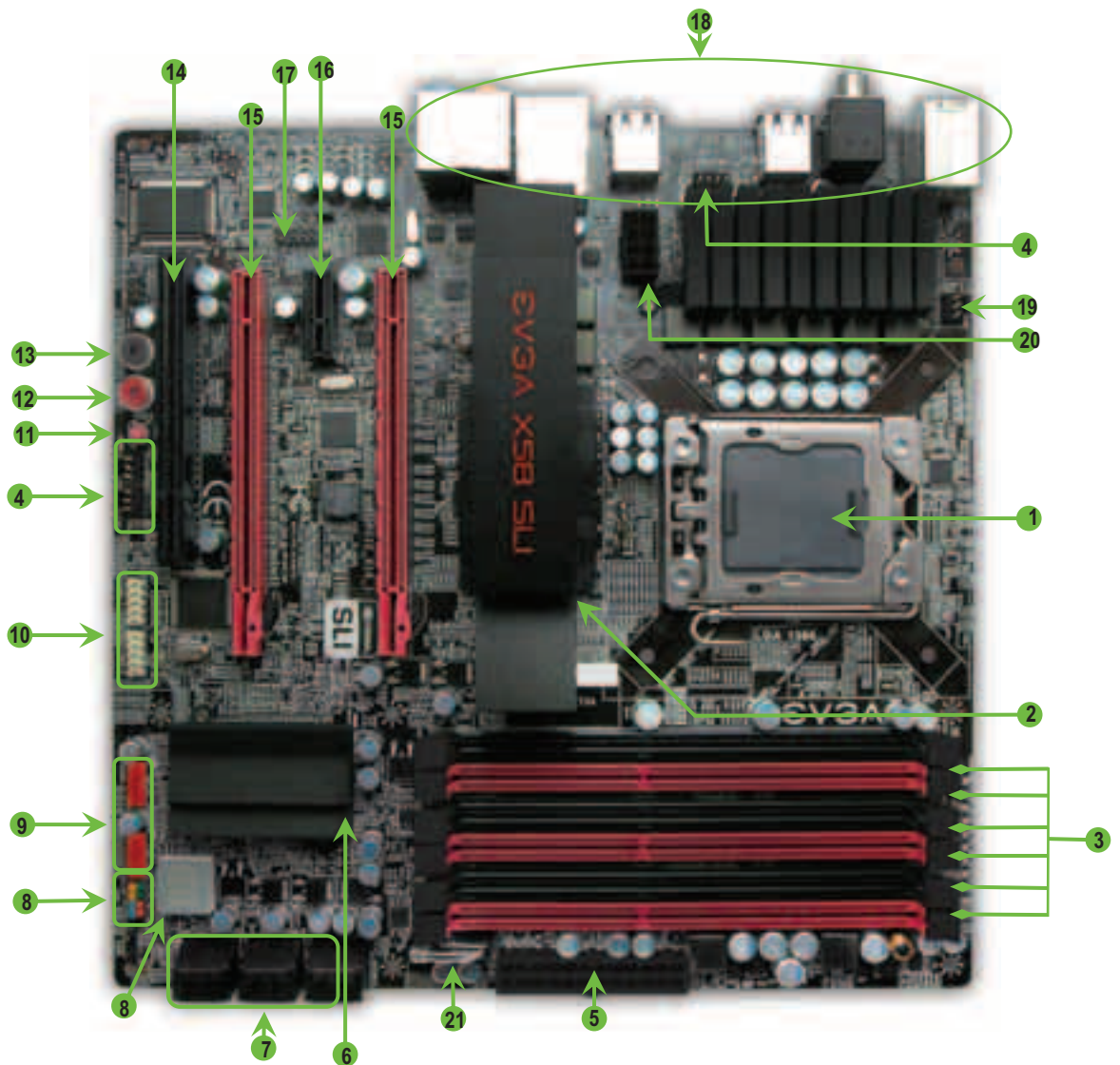

1. CPU Socket 1366	9. USB Headers	17. Front Panel Audio Connector
2. Intel X58 Chipset	10. IEEE1394a Connector	18. Back Panel Connectors (Figure 2)
3. DDR3 DIMM Slots 1 – 6	11. Clear CMOS Button	19. CPU Fan Connector
4. Fan Connectors	12. Power Button	20. 8-pin ATX_12V Power Connector
5. 24-Pin ATX Power Connector	13. Reset Button	21. Motherboard Battery
6. Intel ICH10R Chipset	14. PCI slot	
7. Serial-ATA (SATA) Connectors	15. PCI Express 2.0 Slots	
8. Front Panel Connector	16. PCI Express x1 Slot	

Figure 1. EVGA X58 SLI Micro Motherboard Layout



1. PS/2 Keyboard Port
2. USB 2.0 Ports (Eight)
3. Coaxial SPDIF Output
4. Optical SPDIF Output
5. LAN Port with LEDs to indicate status:

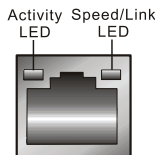

Activity LED Status	Description
Off	No data transmission
Blinking (Green)	Data transmission

Speed/Link LED Status	Description
Yellow	1000 Mbps data rate
Green	100 Mbps data rate
Off	10 Mbps data rate

6. Audio Port	2-Channel	6-Channel	8-Channel
Blue	Line-In	Line-In	Line-In
Green	Line-Out	Front Speaker Out	Front Speaker Out
Pink	Mic In	Mic In	Mic In
Orange		Center/Subwoofer	Center/Subwoofer
Black		Rear Speaker Out	Rear Speaker Out
Grey			Side Speaker Out

Figure 2. Chassis Back Panel Connectors

Hardware Installation

This section will guide you through the installation of the motherboard. The topics covered in this section are:

- ❑ Preparing the motherboard
 - Installing the CPU
 - Installing the CPU fan
 - Installing the memory
- ❑ Installing the motherboard
- ❑ Connecting cables

Safety Instructions

To reduce the risk of fire, electric shock, and injury, always follow basic safety precautions.

Remember to remove power from your computer by disconnecting the AC main source before removing or installing any equipment from/to the computer chassis.

Preparing the Motherboard

Installing the CPU

Be very careful when handling the CPU. Hold the processor only by the edges and do not touch the bottom of the processor.

Use the following procedure to install the CPU onto the motherboard:

Unhook the socket lever by pushing *down* and *away* from the socket.

Put your finger on the tail of the load plate and press down with light pressure to lift the load plate up.

Lift the load plate. There is a protective socket cover within the CPU socket to protect the socket when there is no CPU installed.

Remove the protective socket cover from the CPU Socket.

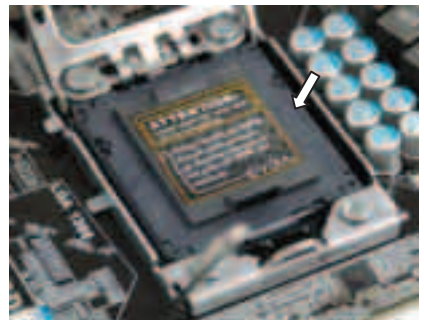

Note: Remove the process from its protective cover, making sure you hold it only by the edges. It is a good idea to save the cover so that whenever you remove the CPU you have a safe place to store it.

Align the notches in the processor with the notches on the socket.

Lower the processor straight down into the socket with out tilting or sliding it into the socket

Note: Make sure the CPU is fully seated and level in the socket.

Close the load plate over the CPU and press down while you close and engage the socket lever.

The CPU installation is complete.

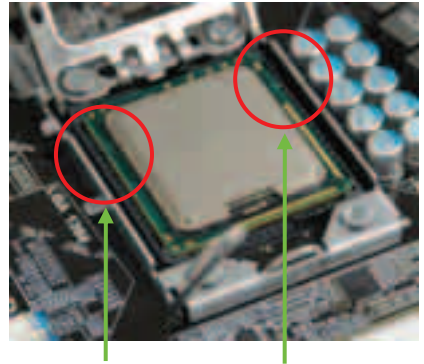

Align notches with notches on the CPU



Installing the CPU Fan

There are many different fan types that can be used with this motherboard. Follow the instruction that came with you fan assembly. Be sure that the fan orientation is correct for your chassis type and your fan assembly.

Installing System Memory (DIMMs)

Your new motherboard has six 240-pin slots for DDR3 memory. These slots support 256 MB, 512 MB, 1GB, 2GB, 4GB DDR3 technologies. There must be at least one memory bank populated to ensure normal operation. Use the following the recommendations for installing memory. (See Figure 1 on page 14 for the location of the memory slots.)

- ❑ **One DIMM:** If using 1 DIMM (**Single Channel**), install into: **DIMM slot 1.**
- ❑ **Two or Four DIMMs:** If using 2 DIMMs (**Dual Channel**), install into: **DIMM slots 1 and 3.** If using 4 DIMMs (**Dual Channel**), install into: **DIMM slots 2, 1, 4, and 3.**
- ❑ **Three DIMMs:** If using 3 DIMMs (**Triple Channel**), install into: **DIMM slots 1, 3 and 5.**

Six DIMMs: If using more than 4 DIMMs, use: **DIMM slots 2, 1, 4, and 3** then proceed to occupy the following DIMM slots **in this order: 5 and 6.**



Use the following procedure to install memory DIMMs. Note that there is only one gap near the center of the DIMM slot. This slot matches the slot on the memory DIMM to ensure the component is installed properly.

1. Unlock a DIMM slot by pressing the module clips outward.

Align the memory module to the DIMM slot, and insert the module vertically into the DIMM slot. The plastic clips at both sides of the DIMM slot automatically lock the DIMM into the connector.

Installing the Motherboard

The sequence of installing the motherboard into a system case depends on the chassis you are using and if you are replacing an existing motherboard or working with an empty system case. Determine if it would be easier to make all the connections prior to this step or to secure the motherboard and then make all the connections. It is normally easier to secure the motherboard first.

Use the following procedure to install the I/O shield and secure the motherboard into the chassis.

Note: Be sure that the CPU fan assembly has enough clearance for the system case covers to lock into place and for the expansion cards. Also make sure the CPU Fan assembly is aligned with the vents on the covers. This will depend on the system case being used.

Installing the I/O Shield

The motherboard kit comes with an I/O shield that is used to block radio frequency transmissions, protects internal components from dust and foreign objects, and promotes correct airflow within the chassis.

Before installing the motherboard, install the I/O shield from the *inside* of the chassis. Press the I/O shield into place and make sure it fits securely. If the I/O shield does not fit into the chassis, you would need to obtain the proper size from the chassis supplier.

Securing the Motherboard into a System Case

Most system cases have a base with mounting studs or spacers to allow the motherboard to be secured to the chassis and help to prevent short circuits. If there are studs that do not align with a mounting hole on the motherboard, it is recommended that you remove that stud to prevent the possibility of a short circuit. In most cases, it is recommended to secure the motherboard using a minimum of nine (9) spacers and screws.

1. Carefully place the motherboard onto the stand off /spacers located inside the chassis.

Align the mounting holes with the studs/spacers.

Align the connectors to the I/O shield.

Ensure that the fan assembly is aligned with the chassis vents according to the fan assembly instruction.

Secure the motherboard with a recommended minimum of nine (9) screws.

Connecting Cables

This section takes you through all the necessary connections on the motherboard. This will include:

- ❑ Power Connections
 - 24-pin ATX power (**PW1**)
 - 8-pin ATX 12V power (**PW12**)
- ❑ Internal Headers
 - Front panel
 - IEEE 1394a
 - USB Headers
 - Audio
- ❑ Serial ATA II
- ❑ Chassis Fans

- ❑ USB 2.0
- ❑ Expansion slots
- ❑ CMOS Clear Button

24-pin ATX Power (PW1)

PW1 is the main power supply connector located along the edge of the board next to the DIMM slots. Make sure that the power supply cable and pins are properly aligned with the connector on the motherboard. Firmly plug the power supply cable into the connector and make sure it is secure.



PW1 connector
Plug power cable from system power supply to PW1

Figure 3. PW1 Motherboard Connector

Table 1. PW1 Pin Assignments

Connector	Pin	Signal	Pin	Signal
	1	+3.3V	13	+3.3V
	2	+3.3V	14	-12V
	3	GND	15	GND
	4	+5V	16	PS_ON
	5	GND	17	GND
	6	+5V	18	GND
	7	GND	19	GND
	8	PWROK	20	RSVD
	9	+5V_AUX	21	+5V
	10	+12V	22	+5V
	11	+12V	23	+5V
	12	+3.3V	24	GND

8-pin ATX 12V Power (PW12)

PW12, the 8-pin ATX 12V power connection, is used to provide power to the CPU. Align the pins to the connector and press firmly until seated.

Connecting Serial ATA Cables

The Serial ATA II connector is used to connect the Serial ATA II device to the motherboard. These connectors support the thin Serial ATA II cables for primary storage devices. The current Serial ATA II interface allows up to 300MB/s data transfer rate.

There are six (6) internal serial ATA connectors on this motherboard. Connection points SATA0 - SATA5, are controlled by the South Bridge Chipset. These connection points support RAID 0, RAID 1, and RAID 10 configurations.



SATA 4 (bottom) SATA 2 (bottom) SATA 0 (bottom)
SATA 5 (top) SATA 3 (top) SATA 1 (top)

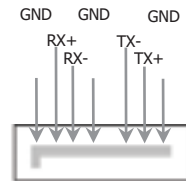

Connect the locking cable end to the motherboard connector.
Connect the end without the lock to the SATA device.

Connecting Internal Headers

Front Panel Header

The front panel header on this motherboard is one connector used to connect the following four cables.

(see Table 2 for pin definitions):

❑ PWRLED

Attach the front panel power LED cable to these two pins of the connector. The Power LED indicates the system's status. When the system is turn on status, the LED is on. When the system is turn off status, the LED is off. When the system is in S1, S1, S3, S4 status, the LED will blink.

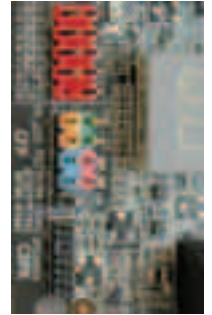
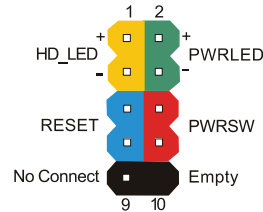

Note: Some system cases do not have all four cables. Be sure to match the name on the connectors to the corresponding pins.

❑ PWRSW

Attach the power button cable from the case to these two pins. Pressing the power button on the front panel turns the system on and off rather than using the onboard button.

❑ HD_LED

Attach the hard disk drive indicator LED cable to these two pins. The HDD indicator LED indicates the activity status of the hard disks.

❑ RESET

Attach the Reset switch cable from the front panel of the case to these two pins. The system restarts when the **RESET** switch is pressed.

Table 2. Front Panel Header Pins

	Pin	Signal
HD_LED	1	HD_PWR
	3	HD Active
PWRLED	2	PWR LED
	4	STBY LED
RESET	5	Ground
	7	RST BTN
PWRSW	6	PWR BTN
	8	Ground
No Connect	9	+5V
Empty	10	Empty

IEEE1394a (Firewire)

This motherboard has two (2) IEEE 1394a onboard headers. Alternatively, you can also connect these to your system case (if applicable)

1. Secure the bracket to either the front or rear panel of the system case (not all system cases are equipped with the front panel option).

Connect the end of the cable(s) to the IEEE1394a headers on the motherboard.

Table 3. IEEE 1394a Connector Pins

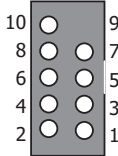
Connector	Pin	Signal
IEEE 1394a Connector 	1	TPA+
	2	TPA-
	3	GND
	4	GND
	5	TPB+
	6	TPB-
	7	+12V
	8	+12V
	9	Empty
	10	GND

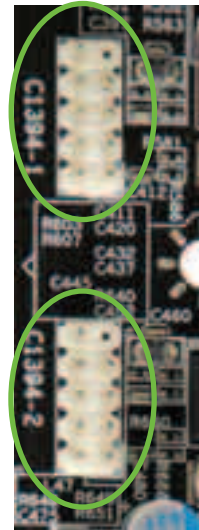

USB Headers

This motherboard contains eight (8) USB 2.0 ports that are exposed on the rear panel of the chassis (Figure 2). The motherboard also contains two 10-pin internal header connectors onboard that can be used to connect an optional external bracket containing four USB 2.0 ports.



1. Secure the bracket to either the front or rear panel of your chassis (not all chassis are equipped with the front panel option).
2. Connect the end of the cable to the USB 2.0 header on the motherboard.

Table 4. USB 2.0 Header Pins

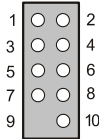
Connector	Pin	Signal
USB 2.0 Header Connector 	1	5V_DUAL
	3	D-
	5	D+
	7	GND
	9	Empty
	Pin	Signal
	2	5V_DUAL
	4	D-
	6	D+
	8	GND
10	No Connect	

Audio

The audio connector supports HD audio standard and provides two kinds of audio output choices: the Front Audio, the Rear Audio. The front Audio supports re-tasking function.

Table 5. Front Audio Connector

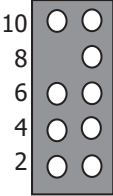
Connector	Pin	Signal
Front Audio Connector 	1	PORT1_L
	2	AUD_GND
	3	PORT1_R
	4	PRECENCE_J
	5	PORT2_R
	6	SENSE1_RETURN
	7	SENSE_SEND
	8	Empty
	9	PORT2_L
	10	SENSE2_RETURN



Fan Connections

There are six fan connections on the motherboard. The fan speed can be CPU Fan detected and viewed in the PC Health Status section of the CMOS Setup. The fans are automatically turned off after the system enters S3, S4 and S5 mode.

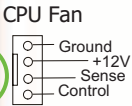
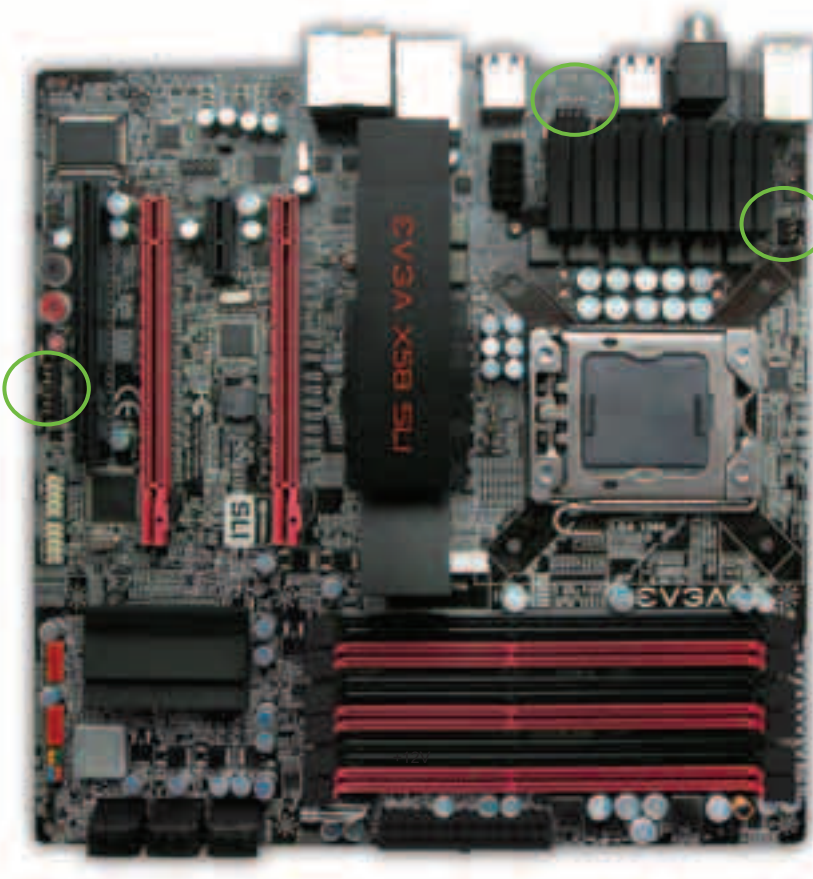

Note: the CPU fan cable can be either a 3-pin or a 4-pin connector. Connect a 3-pin connector to pins 1, 2, and 3 on the motherboard connector.

Expansion Slots

The EVGA X58 SLI Micro Motherboard contains four (4) expansion slots, two (2) PCI Express slots and two (1) PCI slot. For a full list of PCI Express graphic cards supported by this motherboard, visit: www.EVGA.com/Products

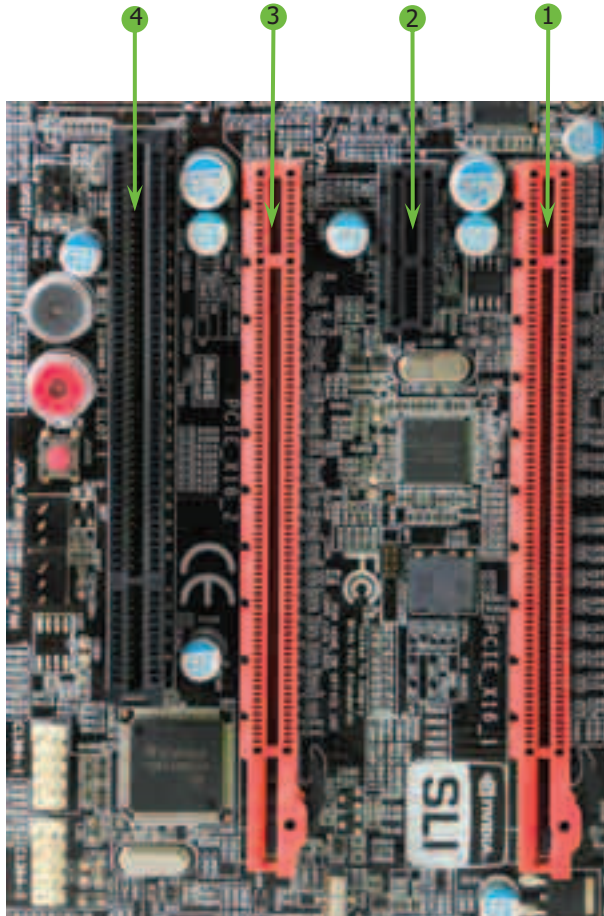

Slot Listing

- 1 - PCI-E 2.0 x16 - Slot 1 (Primary)
- 2 - PCI-E x1 - Slot 1
- 3 - PCI-E 2.0 x16 - Slot 2
- 4 - PCI - Slot 1

PCI Slots

The PCI slot supports many expansion cards such as a LAN card, USB card, SCSI card and other cards that comply with PCI specifications. When installing a card into the PCI slot, be sure that it is fully seated. Secure the card's metal bracket to the chassis back panel with the screw used to hold the blank cover.

PCI Express x1 Slots

There is one PCI Express x1 slot that is designed to accommodate PCIe 1x cards, such as a Killer Xeno Network Card or Sound Card. The x1 slot provides 250 MB/sec bandwidth.

PCI Express x16/x8/x4 Slots

These PCI Express slots are reserved for Graphic Cards and PCI Express x1 and x4 devices. The design of this motherboard supports multiple Graphic Card technology.

When installing a PCI Express Graphic Card, be sure the retention clip snaps and locks the card into place. If the card is not seated properly, it could cause a short across the pins. Secure the card's metal bracket to the chassis back panel with the screw used to hold the blank cover.

Onboard Buttons

These onboard buttons include RESET, POWER and Clear CMOS. These functions allow you to easily reset the system, turn on/off the system, or clear the CMOS.

RESET and POWER Button

These onboard buttons allow you to easily turn on/off the system. These buttons allow for easy debugging and testing of the system during troubleshooting situations.

The POWER button with LED indicates the system's status. When the system is powered on, the LED remains a solid green.

The RESET button with an integrated LED indicates the activity status of the hard disk drives and will flicker accordingly.

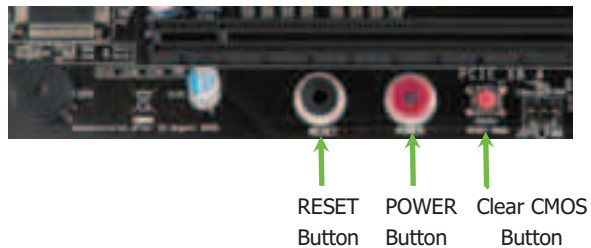

Post Port Debug LED and LED Status Indicators

Post Port Debug LED

Provides two-digit POST codes to show why the system may be failing to boot. It is useful during troubleshooting situations. This Debug LED will also display current CPU temperatures after the system has fully booted into the Operating System.



Debug LED with CPU Temperature Monitor

LED Status Indicators

These LEDs indicate the system's status.

- ❑ POWER LED (Green):
When the System is powered on: This LED is on.
- ❑ DIMM LED (Yellow):
When the Memory slot is functional: This LED is on.
- ❑ STANDBY LED (Blue):
When the System is in Standby Mode: This LED is on. This LED will remain on as long as the motherboard is receiving constant power.

Configuring the BIOS

This section discusses how to change the system settings through the BIOS Setup menus. Descriptions of the BIOS parameters are also provided.

This section includes the following information:

- ❑ Enter BIOS Setup
- ❑ Main Menu
- ❑ Standard CMOS Features
- ❑ Advanced BIOS Features
- ❑ Integrated Peripherals
- ❑ Power Management Setup
- ❑ PnP/PCI Configurations
- ❑ PC Health Status
- ❑ Frequency/Voltage Control

Enter BIOS Setup

The BIOS is the communication bridge between hardware and software. Correctly setting the BIOS parameters is critical to maintain optimal system performance.

Use the following procedure to verify/change BIOS settings.

3. Power on the computer.
4. Press the **Del** key when the following message briefly displays at the bottom of the screen during the Power On Self Test (POST).

Press F1 to continue, DEL to enter Setup.

Pressing **Del** takes you to the Phoenix-Award BIOS CMOS Setup Utility.

Note: It is *strongly* recommended that you do not change the default BIOS settings. Changing some settings could damage your computer.

Main Menu

The main menu allows you to select from the list of setup functions and two exit choices. Use the **Page Up** and **Page Down** keys to scroll through the options or press **Enter** to display the associated submenu. Use the **↑↓** arrow keys to position the selector in the option you choose. To go back to the previous menu, press **Esc**.

Note: that on the BIOS screens all data in **white** is for information only, data in **yellow** is changeable, data in **blue** is non-changeable, and data in a **red box** is highlighted for selection.

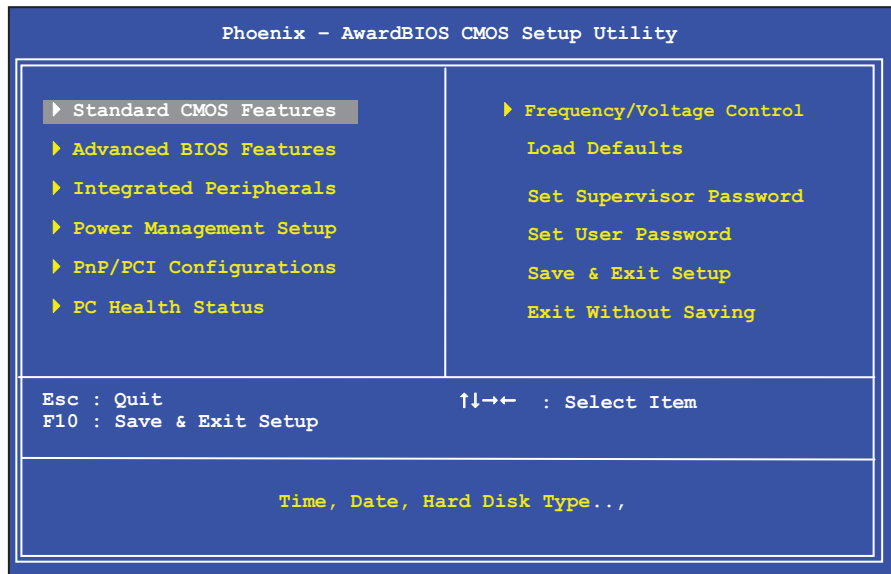

Figure 4. BIOS CMOS Setup Utility Main Menu

- ❑ **Standard CMOS Features**
Use this menu to set up the basic system configuration.
- ❑ **Advanced BIOS Features**
Use this menu to set up the advanced system features and boot sequence.
- ❑ **Integrated Peripherals**
Use this menu to set up onboard peripherals such as IDE, RAID, USB, LAN, and MAC control.
- ❑ **Power Management Setup**
Use this menu to configure power management, power on, and sleep features.
- ❑ **PnP/PCI Configurations**
Use this menu to modify the system's Plug-and-Play and PCI configurations.
- ❑ **PC Health Status**
Use this menu to monitor the real-time system status of your PC, including temperature, voltages, and fan speed.

❑ **Frequency/Voltage Control**

Use this menu to optimize system performance and configure clocks, voltages, memory timings, and more.

The following items on the CMOS Setup Utility main menu are commands rather than submenus:

❑ **Load Defaults**

Load defaults system settings.

❑ **Set Supervisor Password/Set User Password**

Use this command to set, change, and disable the password used to access the BIOS menu.

❑ **Save & Exit Setup**

Use this command to save settings to CMOS and exit setup.

❑ **Exit Without Saving**

Use this command to abandon all setting changes and exit setup.

Standard CMOS Features Menu

The Standard CMOS Features menu is used to configure the standard CMOS information, such as the date, time, HDD model, and so on. Use the **Page Up** and **Page Down** keys to scroll through the options or press **Enter** to display the sub-menu. Use the **↑↓** arrow keys to position the selector in the option you choose. To go back to the previous menu, press **Esc**.

The information shown in **Item Help** corresponds to the option highlighted.

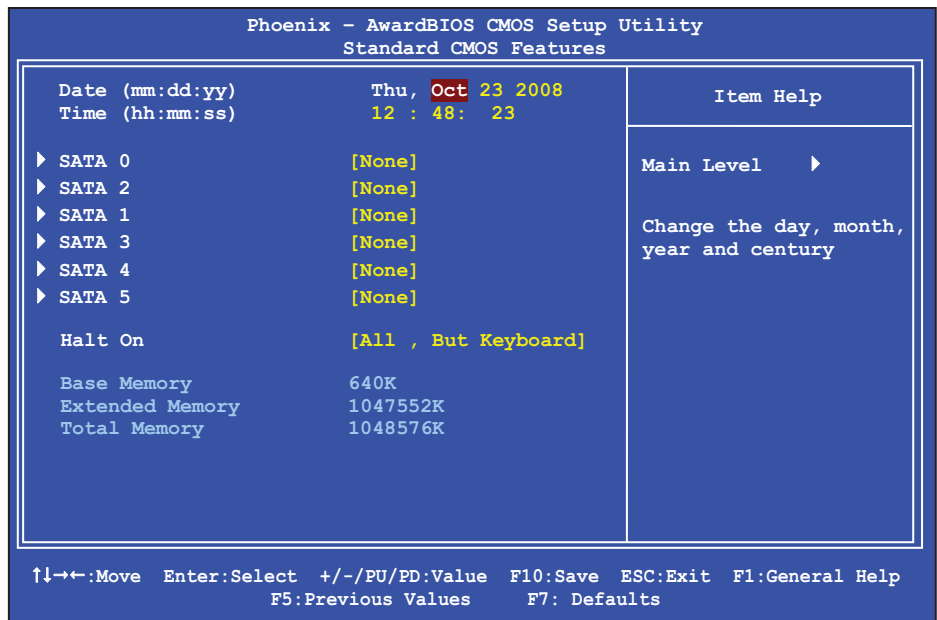

Figure 5. Standard CMOS Features Menu

Note that all data in **white** is for information only, data in **yellow** is changeable, data in **blue** is non-changeable, and data in a **red box** is highlighted for selection.

Date and Time

Using the arrow keys, position the cursor over the month, day, and year. Use the **Page Up** and **Page Down** keys to scroll through dates and times. Note that the weekday (Sun through Sat) cannot be changed. This field changes to correspond to the date you enter. Note that the hour value is shown in a 24-hour clock format. Time is represented as `hour : minute : second`.

```
Date (mm:dd:yy)      Sat, Jul 01 2006
Time (hh:mm:ss)     14 : 48 : 43
```

SATA Channel

Use these functions to detect and configure the SATA channels. Select a channel and press **Enter** to display the SATA sub-menu.

```
▶ SATA 0      [None]
▶ SATA 2      [None]
▶ SATA 1      [None]
▶ SATA 3      [None]
▶ SATA 4      [None]
▶ SATA 5      [None]
```

Press ENTER to display
SATA Channel sub-menu

IDE Auto-Detect	[Press Enter]
Extended IDE Drive Access Mode	[None] Auto
Capacity	0 MB
Cylinder	0
Head	0
Precomp	0
Landing Zone	0
Sector	0

Press **Enter** to auto-detect IDE and SATA channels in the system. Once the channel is detected, the values for Capacity, Cylinder, Heads, Precomp, Landing Zone, and Sector are automatically filled in.

❑ **None**

There is no HDD installed or set.

❑ **Auto**

The system can auto-detect the hard disk when booting up.

❑ **Manual**

When you set the channel to **[Manual]** and change **Access Mode** to **[CHS]**, you can then enter the number of cylinders, heads, precomp, landing zone, and sector. You can manually enter the values or you can press **Enter** to display a window that tells you the min and max values.

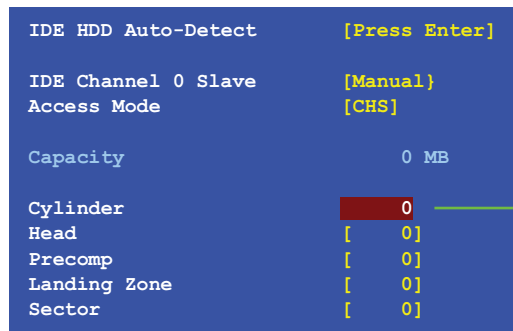

Press ENTER to display sub-menu or enter number manually

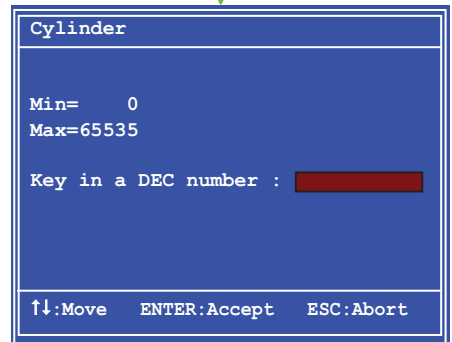

The BIOS supports the following HDD Access Modes:

CHS

For HDD less than 528 MB.

LBA

For HDD greater than 528 MB and supporting LBA (Logical Block Addressing).

Large

For HDD greater than 528 MB but not supporting LBA.

Auto

Recommended mode.

Halt On

Halt On determines whether or not the computer stops if an error is detected during power on. Use the **Page Up** and **Page Down** keys to scroll through the options or press **Enter** to display the **Halt On** sub-menu. Use the **↑↓** arrow keys to position the selector in the option you choose. Press **Enter** to accept the changes and return to the Standard CMOS Features menu.

Halt On	[All , But Keyboard]	Press ENTER to display sub-menu
---------	----------------------	---------------------------------

- ❑ **All Errors**
Whenever the BIOS detects a nonfatal error, the system stops and prompts you.
- ❑ **No Errors**
System boot does not stop for any detected errors.
- ❑ **All, But Keyboard**
System boot does not stop for keyboard errors, but does stop for all other errors.

Halt On

All Errors	[]
No Errors	[]
All , But Keyboard	[■]

↑↓:Move ENTER:Accept ESC:Abort

Memory

These settings are *display-only values* that are determined by the BIOS POST (Power-On Self Test).

- ❑ **Base Memory**
BIOS POST determines the amount of base (or conventional) memory installed in the system.
- ❑ **Extended Memory**
BIOS determines how much extended memory is present during the POST.
- ❑ **Total Memory**
This value represents the total memory of the system.

Base Memory	640K
Extended Memory	1047552K
Total Memory	1048576K

Advanced BIOS Features

Access the Advanced BIOS Features menu from the CMOS Utility Setup screen. Use the **Page Up** and **Page Down** keys to scroll through the options or press **Enter** to display the sub-menu. Use the **↑↓** arrow keys to position the selector in the option you choose. To go back to the previous menu, press **Esc**.

The options that have associated sub-menus are designated by a **▶**, which precedes the option. Press **Enter** to display the sub-menus.

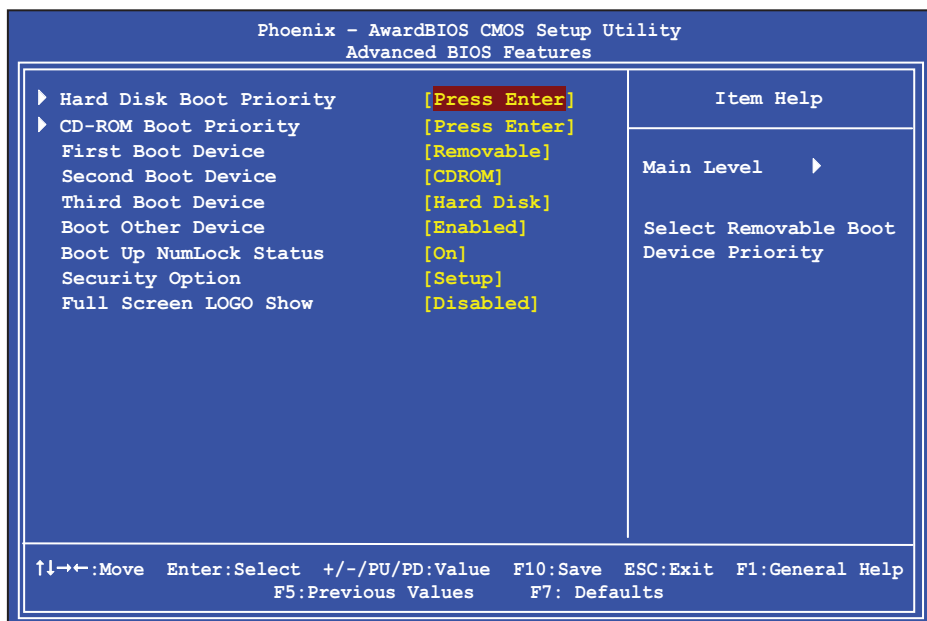

Figure 6. Advanced BIOS Features Menu

Note: That all data in **white** is for information only, data in **yellow** is changeable, data in **blue** is non-changeable, and data in a **red box** is highlighted for selection.

Hard Disk Boot Priority

Use this option to select the priority for HDD startup. Press **Enter** to see the list of bootable devices in your system. Use the **↑↓** arrow keys to go to the various devices. Then use the **+** or **-** keys to move the device priority up or down in the list. To go back to the previous menu, press **Esc**.

```
1. Ch0. : ST3802110A
2. Bootable Add-in Cards
```

Use the **+** and **-** keys to move the priority of the device within the list

CD-ROM Device Priority

Use this option to select the priority for CD-ROM startup. Press **Enter** to see the list of removable devices in your system. Use the **↑↓** arrow keys to go to the various devices. Then use the **+** or **-** keys to move the device priority up or down in the list. To go back to the previous menu, press **Esc**.

```
1. Ch0 M. : BENQ DVD DC DW1810
```

First/Second/Third Boot Device

Use this option to set the priority sequence of the devices booted at power on. Use the **Page Up** and **Page Down** keys to scroll through the options or press **Enter** to display the sub-menu. Use the **↑↓** arrow keys to position the selector in the option you choose.

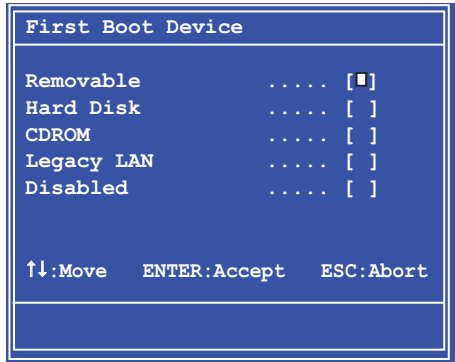

Boot Other Device

With the option set to **Enable**, the system boots from some other device if the first/second/third boot devices fail.

Boot Up NumLock Status

This option allows you to select the power-on state of **NumLock**. Select **On** to activate the keyboard **NumLock** when the system is started. Select **Off** to disable the **NumLock** key.

Security Option

The Security Options allows you to require a password every time the system boots or only when you enter setup. Select **Setup** to require a password to gain access to the CMOS Setup screen. Select **System** to require a password to access the CMOS Setup screen and when the system boots.

Integrated Peripherals Menu

Select **Integrated Peripherals** from the CMOS Setup Utility menu and press **Enter** to display the Integrated Peripherals menu.

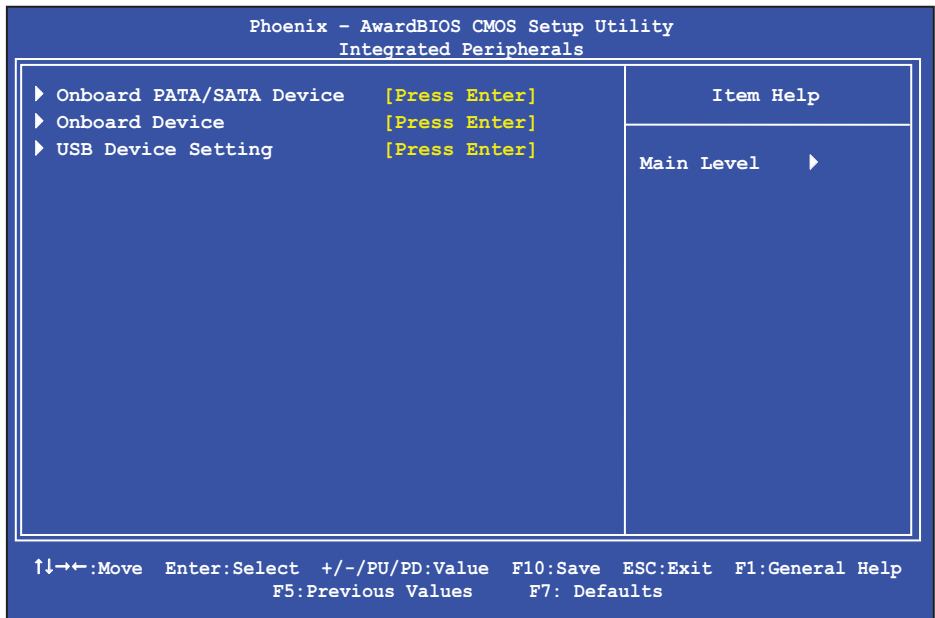
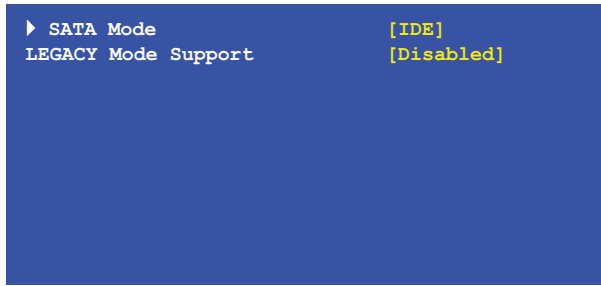

Figure 7. Integrated Peripherals Menu

Onboard SATA Device

Press **Enter** to display the Onboard PATA/SATA Device menu.



❑ SATA Mode

This allows you to set the onboard Serial SATA mode.

IDE: Use the Serial ATA hard disk drivers as Parallel ATA storage devices.

RAID: Create a RAID 0, RAID 1, RAID 10, and RAID 5 configuration

AHCI: Use the AHCI (Advanced Host Controller Interface) to enable advanced SATA features for improved performance with NCQ and Hot-plug features

❑ LEGACY Mode Support

This function allows the SATA controller to operate in LEGACY mode.

Selected Disabled if you install an operating system that supports Native mode.

Onboard Device

Press **Enter** to display the Onboard Device menu.

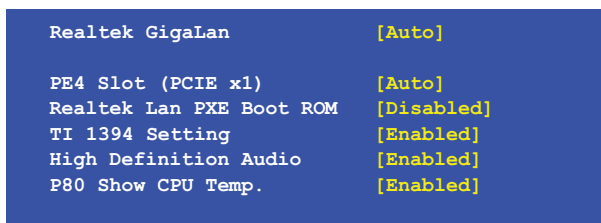

- ❑ **Realtek GigaLan**
Use this function to set the onboard Realtek GigaLan function for LAN1. The options are Auto, Enabled and Disabled.
- ❑ **PE4 Slot (PCIe x1)**
Use this function to set the PCI-e x1 Slot function. The options are Auto, Enabled and Disabled.
- ❑ **Realtek Lan PXE Boot ROM**
This function allows you to enable or disable the onboard Realtek Lan PXE Boot ROM for booting from LAN.
- ❑ **High Definition Audio**
This function allows you to enable or disable the onboard Realtek High Definition Audio.
- ❑ **TI 1394 Setting**
This function allows you to enable or disable the IEEE1394 (Firewire) interface.
- ❑ **P80 Show CPU Temp.**
When this function is enabled the onboard Post Port LED will display the CPU temperature.

USB Device Settings

Press **Enter** to display the USB Device Settings menu.

```

USB 1.0 Controller      [Enabled]
USB 2.0 Controller     [Enabled]
USB Operation Mode     [High Speed]
USB Keyboard Function  [Enabled]
USB Mouse Function     [Enabled]
USB Storage Function   [Enabled]

*** USB Mass Storage Device Boot Setting ***

```

- ❑ **USB 1.0 Controller**
Use this function to enable the USB 1.0 controller.
- ❑ **USB 2.0 Controller**
Use this function to enable the USB 2.0 (EHCI) controller.

- ❑ **USB Operation Mode**
Select the USB Operation Mode for USB device. Options are Full/Low Speed and High Speed.
- ❑ **USB Keyboard Function**
Use this function to enable or disable support for USB keyboard under DOS.
- ❑ **USB Mouse Function**
Use this function to enable or disable support for USB mouse under DOS
- ❑ **USB Storage Function**
Use this function to enable or disable legacy support of USB Mass Storage

Power Management Setup Menu

Select **Power Management Setup** from the CMOS Setup Utility menu and press **Enter** to display the Power Management Setup menu.

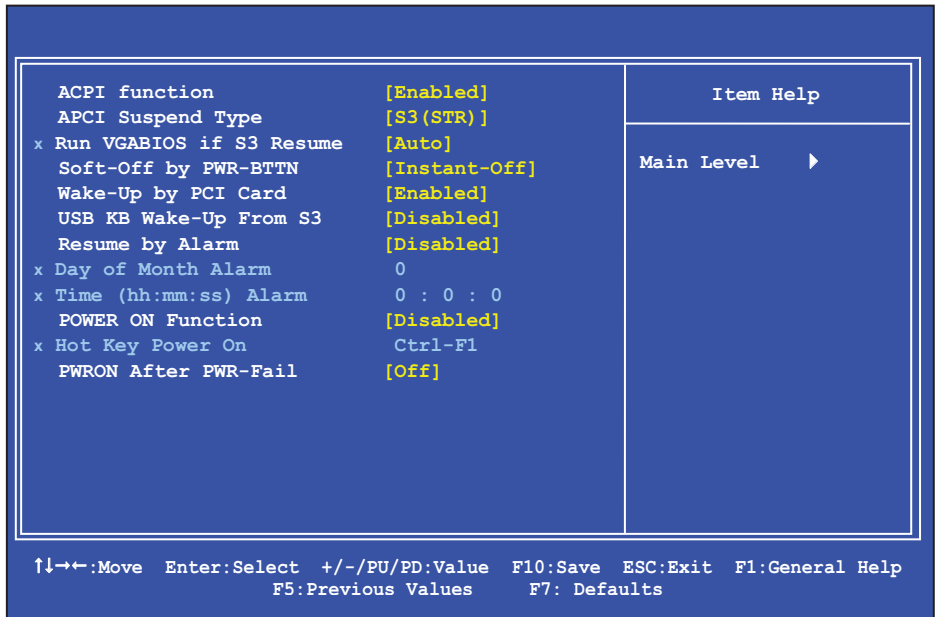

Figure 8. Power Management Setup Menu

ACPI Function

This function on the Power Management Setup menu allows you to enable or disable the ACPI function.

ACPI Suspend Type

This function on the Power Management Setup menu allows you to select an ACPI Suspend Type. Types to select from are **[S1&S3]**, **[S1 (POS)]**, and **[S3 (STR)]**.

Run VGABIOS if S3 Resume

This function on the Power Management Setup menu allows you determines whether or not to enable the system to run the VGA BIOS when resuming from S3(STR) or S1&S3. The Options are Auto, Yes and No.

Soft-Off by PWR-BTTN

This function on the Power Management Setup menu allows you to set Soft-Off by PBNT to **[Instant-Off]** or **[Delay 4 Sec]**.

Wake-Up by PCI Card

This function on the Power Management Setup menu allows PCI Card to wake-up the system from Soft-off state.

USB KB Wake-Up From S3

This function on the Power Management Setup menu allows a USB keyboard device to wake-up the system from S3 state.

Resume by Alarm

This function on the Power Management Setup menu allows you to enable or disable the Power-on by alarm function. Set to **[Disable]** to prevent power-

on by alarm. When set to **[Enable]**, you can manually put in the day of the month and the time of the alarm.

```
Day of Month Alarm      [ 0 ]
Time (hh:mm:ss) Alarm  [0 : 0 : 0]
```

To enter a day or time, use the **Page Up** and **Page Down** keys to scroll through numbers or enter the number using the keyboard number or the **+** and **-** keys.

POWER ON Function

This function on the Power Management Setup menu allows you to define the power-on function. Options for this function are:

- Disabled
- Keyboard

Hot Key Power On

Use this function with the above “POWER ON Function” to set a combination of keys that can be used to power on the system. Options for this function are:

- Ctrl-Esc
- Ctrl-F1
- Ctrl-Space
- Anykey

PWRON after PWR-Fail

This function enables your computer to automatically restart or return to its last operating status after power returns from a power failure.

Off: The system stays off after a power failure.

On: The system stays on after a power failure

PnP/PCI Configuration Menu

Select **PnP/PCI Configuration** from the CMOS Setup Utility menu and press **Enter** to display the PnP/PCI Configuration menu.

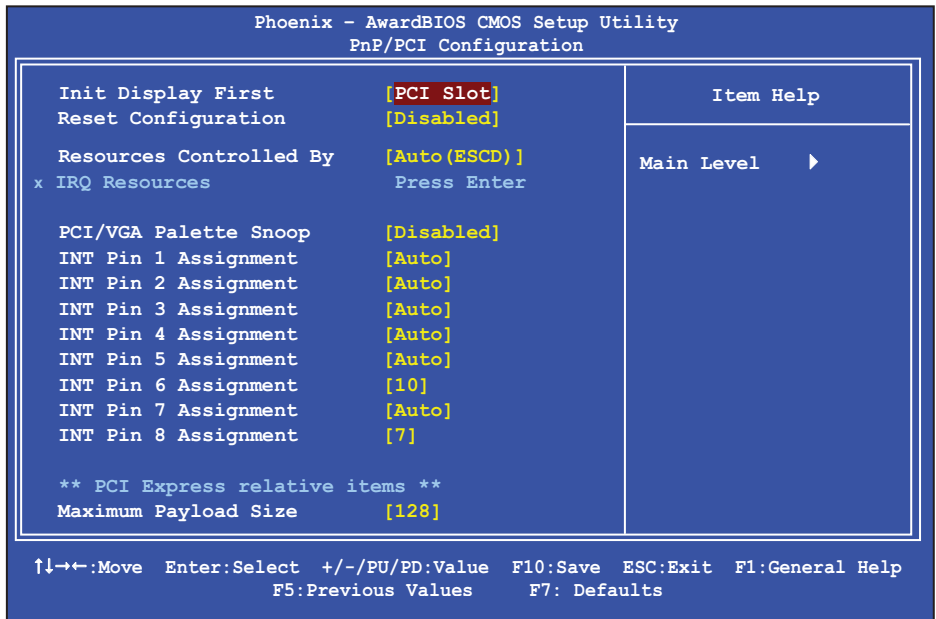

Figure 9. PnP/PCI Configuration Menu

Init Display First

This function on the PnP/PCI Configuration menu allows you to define if the initial display is in the PCI slot or in the PCI Express slot. Options are **[PCI Slot]** and **[PCIEx]**.

Reset Configuration

This function on the PnP/PCI Configuration menu allows you to enable or disable the resetting of Extended System Configuration Data (ESCD) when you exit Setup. Set this to [Enabled] if you have installed a new add-on and the system reconfiguration has caused a serious conflict that prevents the OS from booting. The default setting is [Disabled].

Resources Controlled By

This function on the PnP/PCI Configuration menu allows you to define if the BIOS can automatically configure all the boot and plug-and-play compatible devices or if you can manually select IRQ, DMA, and memory base address fields. Select **[Auto (ESCD)]** if you want the BIOS to automatically populate these fields. If you select **[Manual]]** so you can assign the resources, **IRQ Resources** is enabled for input.

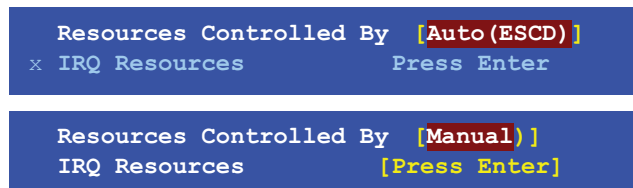

IRQ Resources

To enable this field for input, set **Resources Controlled By** to **[Manual]]**. With this field enabled, press **Enter** to see options.

```
IRQ-5 assigned to [PCI Device]
IRQ-9 assigned to [PCI Device]
IRQ-10 assigned to [PCI Device]
IRQ-11 assigned to [PCI Device]
IRQ-12 assigned to [PCI Device]
IRQ-14 assigned to [PCI Device]
IRQ-15 assigned to [PCI Device]
```

Use Legacy ISA for devices compliant with the original PC AT Bus specification. Use PCI/ISA PnP for devices compliant with the plug-and-play standard, whether designed for PCI or ISA Bus architecture.

PCI/VGA Palette Snoop

This item is designed to overcome problems that may be caused by some nonstandard VGA cards..

INT Pin 1/2/3/4/5/6/7/8 Assignment

This function on the PnP/PCI Configuration menu allows you to set the INT Pin 1/2/3/4/5/6/7/8 Assignment.

Maximum Payload Size

This function on the PnP/PCI Configuration menu allows you to set the maximum TLP payload size (in bytes) for the PCI Express devices. Use the **Page Up** and **Page Down** keys to scroll through sizes or enter the number using the keyboard numbers or use the **+** and **-** keys to go up and down the list of sizes.

PC Health Status Menu

Select **PC Health Status** from the CMOS Setup Utility menu and press **Enter** to display the PC Health Status menu.

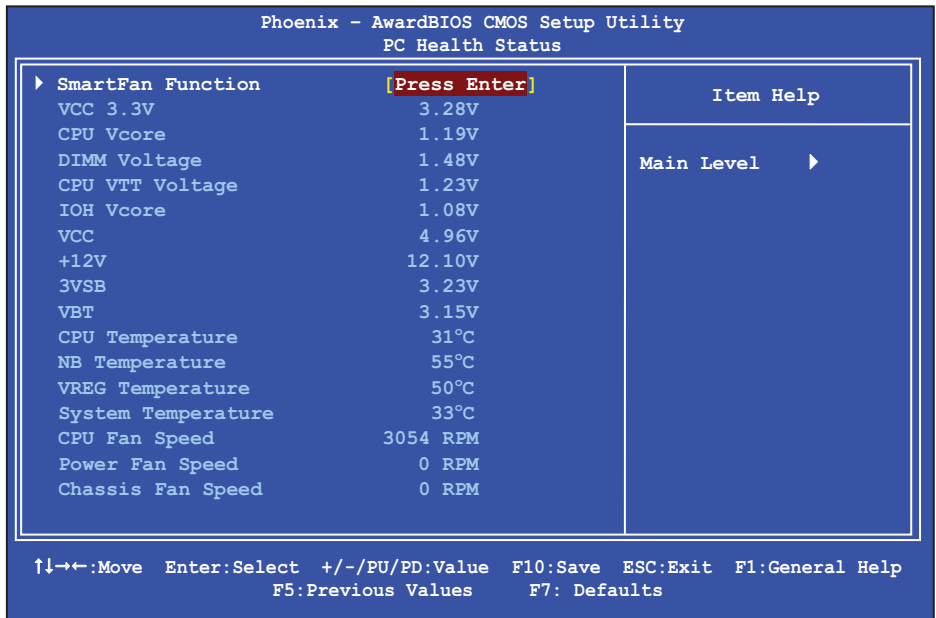

Figure 10. PC Health Status Menu

All of the values shown in **Blue** are dynamic and change as the speed and voltages of the various components change with system usage.

SmartFan Function

Press **Enter** to display the SmartFan Function menu.

```
CPU Fan Speed Control      [SmartFan]
x Manual Fan Speed, %      100
  If temp > 60°C, Set Fan Speed 100%
  If temp < 30°C, Set Fan Speed  50%

Power Fan Speed Control    [SmartFan]
x Manual Fan Speed, %      100
  If temp > 60°C, Set Fan Speed 100%
  If temp < 30°C, Set Fan Speed  50%

Chassis Fan Speed Control  [SmartFan]
x Manual Fan Speed, %      100
  If temp > 60°C, Set Fan Speed 100%
  If temp < 30°C, Set Fan Speed  50%
```

Use this menu to control the speed of the various fans on the motherboard. Set CPU fan speed to **[SmartFan]** when you want the speed of the fans automatically controlled based on temperature. To set the fan speed to a constant rate, select **[Manual]** and then enter the speed from 0% to 100%.

Set the desired speed for the Power and Chassis fans from 0% to 100%. The system defaults to 100%.

Frequency/Voltage Control Menu

Select **Frequency/Voltage Control** from the CMOS Setup Utility menu and press **Enter** to display the Frequency/Voltage Control menu.

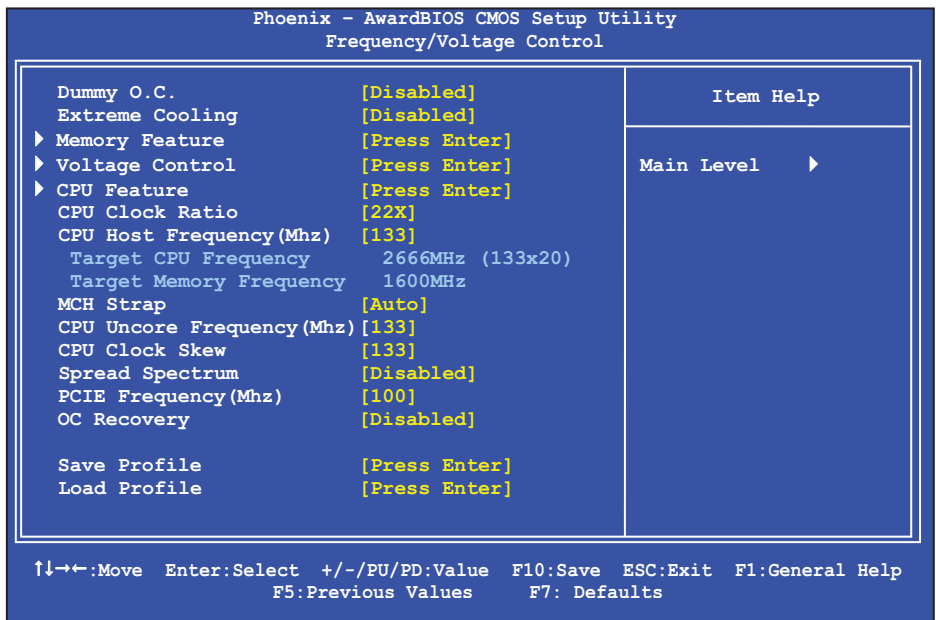

Figure 11. Frequency/Voltage Control Menu

Memory Feature

Select **Memory Feature** from the Frequency/Voltage Control menu and press **Enter** to display the Memory Feature menu.

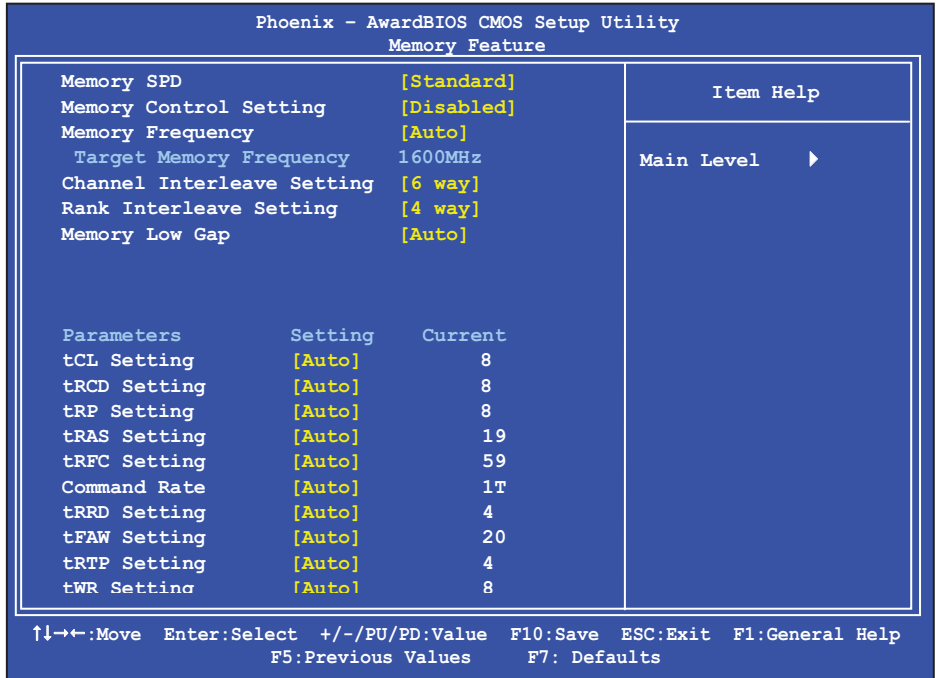

Figure 12. Memory Feature Menu

- ❑ **Memory Control Setting**
This function is allows you to select the Memory Control Setting.
- ❑ **Memory Frequency**
This function is allows you to select the Memory Frequency. The options are Auto, 800Mhz, 1067Mhz, 1333Mhz, and 1600Mhz.
- ❑ **Channel Interleave Setting**
This function is allows you to select the Channel Interleave Setting. The options are 1 way, 2 way, 3 way, 4 way, 5 way and 6 way.

- ❑ **Rank Interleave Setting**
This function allows you to select the Rank Interleave Setting. The options are 1 way, 2 way and 4 way.
- ❑ **tCL Setting**
This function is set the CAS latency. The options are 0 through 18.
- ❑ **tRCD Setting**
This function is set the RAS to CAS Delay for Read/Write commands to the same bank. The options are 0 through 15.
- ❑ **tRP Setting**
This function is set the Row Precharge time. This is the Precharge-to-Active or Auto-to-Refresh of the same bank. The options are 0 through 15.
- ❑ **tRAS Setting**
This function is set the minimum RAS# active time. The options are 0 through 31.
- ❑ **Command Rate**
This function is set the command timing setting on a per clock unit basis. The options are Auto, 1T and 2T.

Voltage Control

Select **Voltage Control** from the Frequency/Voltage Control menu and press **Enter** to display the Voltage Control menu.

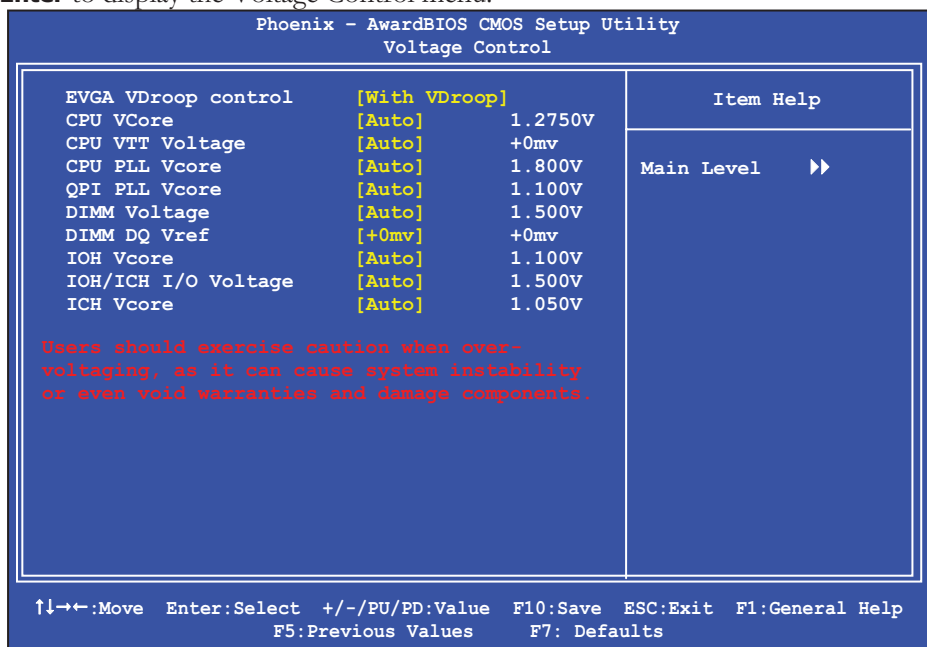

Figure 13. Voltage Control

- ❑ **EVGA VDroop Control**
EVGA VDroop control is a safety measure by motherboards to protect the CPU. Select [With VDroop] to calibrate CPU VDroop or select [Without VDroop] to disable this function
- ❑ **CPU VCore**
Use the **Page Up** and **Page Down** keys to scroll through the voltages or select [Auto] to automatically set the voltage level for the CPU Core.
- ❑ **CPU VTT Voltage**
Use the **Page Up** and **Page Down** keys to scroll through the voltages or select [Auto] to automatically set the voltage level for the CPU VTT Voltage.

- ❑ **CPU PLL VCore**
Use the **Page Up** and **Page Down** to scroll through the voltages or select [Auto] to automatically set the voltage level for the CPU PLL Voltage.
- ❑ **QPI PLL VCore**
Use the **Page Up** and **Page Down** to scroll through the voltages or select [Auto] to automatically set the voltage level for the QPI PLL Voltage.
- ❑ **DIMM Voltage**
This function defines the voltage level for the DRAM. Use the **Page Up** and **Page Down** keys to select a voltage or select [Auto] to automatically set the voltage.
- ❑ **DIMM DQ Vref**
This function defines the voltage level for the DRAM DQ Vref. Use the **Page Up** and **Page Down** keys to select and set the voltage.
- ❑ **IOH VCore**
This function defines the core voltage level for the Intel IOH chip. Use the **Page Up** and **Page Down** keys to select a voltage or select [Auto] to automatically set the voltage.
- ❑ **IOH/ICH I/O Voltage**
This function defines the core voltage level for the Intel IOH/ICH I/O voltage. Use the **Page Up** and **Page Down** keys to select a voltage or select [Auto] to automatically set the voltage.
- ❑ **ICH VCore**
This function defines the core voltage level for the Intel ICH chip. Use the **Page Up** and **Page Down** keys to select a voltage or select [Auto] to automatically set the voltage.

CPU Feature

Select **CPU Feature** from the Frequency/Voltage Control menu and press **Enter** to display the CPU Feature menu.

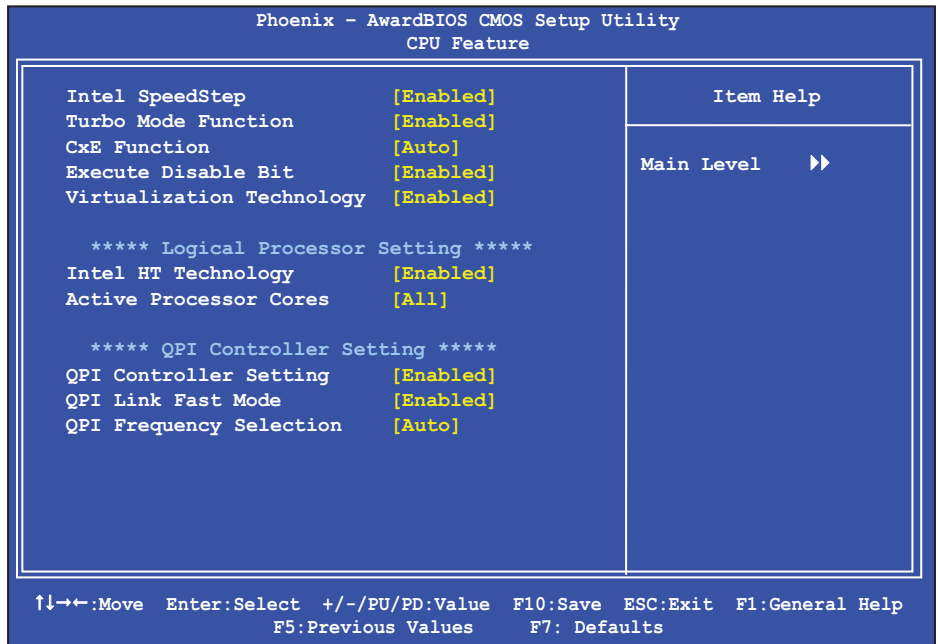

Figure 14. CPU Feature Menu

❑ **Intel SpeedStep**

Use this function to enable the Intel SpeedStep technology (EIST). The options are Enabled and Disabled.

❑ **Turbo Mode Function**

Use this function to enable the Intel Turbo Mode Function. The options are Enabled and Disabled.

❑ **CxE Function**

This function allows you to select the lowest C state supported according as CPU and MB. The options are Auto, Disabled, C1, C1E, C3 and C6.

❑ **Execute Disable Bit**

When this function is disabled, it forces the XD feature flag to always return to zero (0).

❑ **Virtualization Technology**

When this function is enabled, it allows a VMM to utilize the additional hardware capabilities provided by Intel Virtualization Technology.

Logical Processor Setting

❑ **Intel HT Technology**

This function is allows you to enable the Intel HT Technology. The options are Enabled and Disabled.

❑ **Active Processor Cores**

This function active number of cores to enable in each processor package. The options are All, 1 and 2.

QPI Controller Setting

❑ **QPI Controller Setting**

This function is allows you to enable the QPI (QuickPath Interconnect) Controller Setting. The options are Enabled and Disabled.

❑ **QPI Link Fast Mode**

This function is allows you to enable the QPI Link Fast Mode. The options are Enabled and Disabled.

❑ **QPI Frequency Selection**

This function is allows you to select the QPI Frequency. The options are Auto, 4.800 GT/s, 5.866 GT/s and 6.400 GT/s.

Installing Drivers and Software

Note: It is important to remember that *before* installing the driver CD that is shipped in the kit, you need to load your operating system. The motherboard supports Windows XP 32bit and 64bit and is Vista-capable.

The kit comes with a CD that contains utilities, drivers, and additional software.

The CD that has been shipped with the EVGA X58 SLI Micro Motherboard contains the following software and drivers:

- Chipset Drivers
- Audio drivers
- RAID drivers
- LAN Drivers
- Matrix Storage
- EVGA E-LEET
- Adobe Acrobat Reader
- User's Manual

Windows XP/Vista Driver Installation

5. Insert the Intel X58 Express installation CD for the motherboard included in the kit.
6. The CD will autorun, install the drivers and utilities listed on the install screen.

If the CD does not run, go to My Computer and click on the CD to open.

Appendix A. POST Codes for the EVGA X58 SLI Micro Motherboard

This section provides the Award POST Codes (Table 6) for the EVGA X58 SLI Micro Motherboard during system boot up.

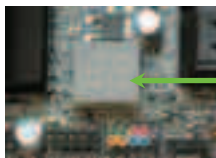

Debug LED with CPU
Temperature Monitor

The POST Codes are displayed on the Debug LED readout located directly onboard the motherboard.

This Debug LED will also display current CPU temperatures after the system has fully booted into the Operating System.

Table 6. Award POST Code

Award POST Codes		
Code	Name	Description
01	Reserved	
02	Jumps to E000 segment	Execution of POST routines in E000
03	Early SuperIO	Init Early Initialized the super IO
04	Reserved	
05	Blank video	Reset Video controller
06	Reserved	
07	Init KBC	Keyboard controller init
08	KB test	Test the Keyboard
09	Reserved	

Award POST Codes		
Code	Name	Description
0A	Mouse Init	Initialized the mouse
0B	Reserved	
0C	Reserved	
0D	Reserved	
0E	Checksum Check	Check the integrity of the ROM, BIOS and message
0F	Reserved	
10	Autodetect EEPROM	Check Flash type and copy flash write/erase routines
11	Reserved	
12	Test CMOS	Test and Reset CMOS
13	Reserved	
14	Load Chipset	Load Chipset Defaults
15	Reserved	
16	Init Clock	Initialize onboard clock generator
17	Reserved	
18	Init CPU	CPU ID and initialize L1/L2 cache
19	Reserved	
1A	Reserved	
1B	Setup Interrupt Vector Table	Initialize first 120 interrupt vectors with SPURIOUS_INT_HDLR and initialize INT 00h-1Fh according to INT_TBL
1C	CMOS Battery Check	Test CMOS and check Battery Fail
1D	Early PM	Early PM initialization
1E	Reserved	
1F	Re-initial KB	Load keyboard matrix
20	Reserved	
21	HPM init	Init Heuristic Power Management (HPM)
22	Reserved	
23	Program chipset	Early Programming of chipset registers

Award POST Codes		
Code	Name	Description
24	Init PNP	Init PNP
25	Shadow VBIOS	Shadow system/video BIOS
26	Clock Gen	Init onboard clock generator and sensor
27	Setup BDA	Setup BIOS DATA AREA (BDA)
28	Reserved	
29	CPU Speed detect	Chipset programming and CPU Speed detect
2A	Reserved	
2B	Init video	Initialize Video
2C	Reserved	
2D	Video memory test	Test Video Memory and display Logos
2E	Reserved	
2F	Reserved	
30	Reserved	
31	Reserved	
32	Reserved	
33	Early keyboard reset	Early Keyboard Reset
34	Reserved	
35	Test DMA Controller 0	Test DMA channel 0
36	Reserved	
37	Test DMA Controller 1	Test DMA channel 1
38	Reserved	
39	Test DMA Page Registers	Test DMA Page Registers
3A	Reserved	
3B	Reserved	

Award POST Codes		
Code	Name	Description
3C	Test Timer	Test 8254 Timer 0 Counter 2.
3D	Reserved	
3E	Test 8259-1 Mask	Verify 8259 Channel 1 masked interrupts by alternately turning off and on the interrupt lines.
3F	Reserved	
40	Test 8259-2 Mask	Verify 8259 Channel 2 masked interrupts by alternately turning off and on the interrupt lines.
41	Reserved	
42	Reserved	
43	Test Stuck Interrupt	Turn off interrupts then verify no 8259's interrupt mask register is on. Test 8259 Force an interrupt and verify the interrupt occurred.
44	Reserved	
45	Reinit serial port	Reinitialize Preboot agent serial port
46	Reserved	
47	EISA Test	If EISA non-volatile memory checksum is good, execute EISA initialization. If not, execute ISA tests and clear EISA mode flag.
48	Reserved	
49	Size Memory	Size base memory from 256K to 640K and extended memory above 1MB.
4A	Reserved	
4B	Reserved	
4C	Reserved	
4D	Reserved	
4E	Init APIC	Initialize APIC and set MTRR
4F	Reserved	
50	USB init	Initialize USB controller
51	Reserved	
52	Memory Test	Test all memory of memory above 1MB using Virtual 8086 mode, page mode and clear the memory
53	Reserved	

Award POST Codes		
Code	Name	Description
54	Reserved	
55	CPU display	Detect CPU speed and display CPU vendor specific version string and turn on all necessary CPU features
56	Reserved	
57	PnP Init Display	PnP logo and PnP early init
58	Reserved	
59	Setup Virus	Setup virus protect according to Protect Setup
5A	Reserved	
5B	Awdflash Load	If required, will auto load Awdflash.exe in POST
5C	Reserved	
5D	Onboard I/O	Init Initializing onboard superIO
5E	Reserved	
5F	Reserved	
60	Setup enable	Display setup message and enable setup functions
61	Reserved	
62	Reserved	
63	Initialize Mouse	Detect if mouse is present, initialize mouse, install interrupt vectors.
64	Reserved	
65	PS2 Mouse special	Special treatment to PS2 Mouse port
66	Reserved	
67	ACPI init	ACPI sub-system initializing
68	Reserved	
69	Init Cache	Initialize cache controller
6A	Reserved	
6B	Setup	Enter setup check and autoconfiguration check up
6C	Reserved	
6D	Initialize	Initialize floppy disk drive

Award POST Codes		
Code	Name	Description
	Floppy	
6E	Reserved	
6F	FDD install	Install FDD and setup BIOS data area parameters
70	Reserved	
71	Reserved	
72	Reserved	
73	Initialize Hard Drive	Initialize hard drive controller
74	Reserved	
75	Detect HDD	IDE device detection
76	Reserved	
77	Detect serial ports	Initialize serial ports.
78	Reserved	
79	Reserved	
7A	Detect parallel ports	Initialize parallel ports.
7B	Reserved	
7C	HDD Write Protect	HDD check for write protection
7D	Reserved	
7E	Reserved	
7F	POST error check	Check POST error and display them and ask for user intervention
80	Reserved	
81	Reserved	
82	Security Check	Ask password security.
83	Write CMOS	Write all CMOS values back to RAM and clear screen.
84	Display PNP	Display PNP devices
85	USB Final Init	Final USB initialization
86	Reserved	
87	Reserved	

Award POST Codes		
Code	Name	Description
88	Reserved	
89	Setup ACPI tables	Setup ACPI tables
8A	Reserved	
8B	Option ROM Detect	Scan for Option ROMs
8C	Reserved	
8D	Enable Parity Check	Enable Parity Check
8E	Reserved	
8F	IRQ12 Enable	Enable IRQ12 if mouse present
90	Reserved	
91	Reserved	
92	Reserved	
93	Boot Medium Read	Detect and store boot partition head and cylinders values in RAM
94	Final Init	Final init for last micro details before boot
95	NumLock	Set NumLock status according to Setup
96	Boot Attempt	Set low stack Boot via INT 19h.
C0	Base CPU test	Read/Write CPU registers
C1	Memory Presence	Base memory detect
C2	Early Memory	Board Initialization
C3	Extend Memory	Turn on extended memory, cache initialization
C4	Special Display	First display initialization
C5	Early Shadow	Early shadow enable for fast boot
C6	Cache presence	External cache size detection
CF	CMOS Check	CMOS checkup
B0	Spurious	If interrupt occurs in protected mode.

Award POST Codes		
Code	Name	Description
B1	Unclaimed NMI	If unmasked NMI occurs, display Press F1 to disable NMI, F2 reboot.
BF	Program MCP	To program chipset from defaults values
E1-EF	Setup Pages	E1- Page 1, E2 - Page 2, etc.
FF	Boot	

EVGA Glossary of Terms

ACPI - Advanced Configuration and Power Interface

AFR – Alternate Frame Rendering

APIC - Advanced Programmable Interrupt Controller

BIOS - Basic Input Output System

CD-ROM - Compact Disc Read-Only Memory

CMOS - Complementary Metal-Oxide Semiconductor

CPU – Central Processing Unit

D-ICE – Dry Ice Cooling

DDR2 - Double Data Rate 2

DDR3 - Double Data Rate 3

DIMM - Dual In-line Memory Module

DRAM - Dynamic random access memory
DVD - Digital Versatile Disc
DVI – Digital Video Interface
FDC - Floppy Disk Controller
FSB – Front Side Bus
FTW – For The Win!
GHz – Gigahertz
GPU – Graphics Processing Unit
HDD - Hard Disk Drive
HDMI - High-Definition Multimedia Interface
HDR – High Dynamic Range Lighting
HPET - High Precision Event Timer
HT – Hyper-Threading
HSF - Heat Sink Fan
I/O - Input/Output
IDE - Integrated Drive Electronics
IEEE - Institute of Electrical and Electronics Engineers
IGP - Integrated Graphics Processors
IRQ - Interrupt Request
JBOD - Just a Bunch of Disks
JEDEC - Joint Electron Device Engineering Council
LAN - Local Area Network
LCD - Liquid Crystal Display
LGA – Land Grid Array
LN2 – Liquid Nitrogen Cooling
MAC - Media Access Control
MCP - Media and Communications Processor
MHz - Megahertz
NB - Northbridge
NCQ - Native Command Queuing

NIC - Network Interface Card
NTFS - New Technology File System
OEM - Original Equipment Manufacturer
PATA - Parallel Advanced Technology Attachment
PCB - Printed Circuit Board
PCI - Peripheral Component Interconnect
PCIe - Peripheral Component Interconnect Express
PCI-x - Peripheral Component Interconnect Extended
POST – Power on Self Test
PWM – Pulse Width Modulation
QDR - Quad Data Rate
QPI – Quick Path Interconnect
RAID - Redundant Array of Inexpensive Disks
RGB - Red Green Blue
SATA - Serial Advanced Technology Attachment
SB - Southbridge
SCSI - Small Computer System Interface
SFR – Split Frame Rendering
SLI - Scalable Link Interface
SPD - Serial Presence Detect
SPDIF - Sony/Philips Digital Interconnect Format
SPP - System Platform Processors
TCP/IP - Transmission Control Protocol/Internet Protocol
USB - Universal Serial Bus
VDroop - V-core Voltage Drop
VGA - Video Graphics Array



EVGA Corp • 2900 Saturn Street, Suite B • Brea, CA 92821 • www.evga.com

Free Manuals Download Website

<http://myh66.com>

<http://usermanuals.us>

<http://www.somanuals.com>

<http://www.4manuals.cc>

<http://www.manual-lib.com>

<http://www.404manual.com>

<http://www.luxmanual.com>

<http://aubethermostatmanual.com>

Golf course search by state

<http://golfingnear.com>

Email search by domain

<http://emailbydomain.com>

Auto manuals search

<http://auto.somanuals.com>

TV manuals search

<http://tv.somanuals.com>