



Installation and Operation Guide

QL2-OW200L Water Filter & Cartridge

Not for use with water preheated over 100 °F (38 °C)

The Everpure QL2-OW200L Water Filter reduces chlorine tastes and odors in drinking water and beverages made with water. The OW200L also filters out dirt and rust, and reduces the formation of limescale which builds-up in water-using appliances that heat or freeze water. Perhaps most important, the OW200L reduces both lead and trihalomethanes (THMs) to below Federal limits.

PARTS LIST

Key Letter	Description	Part No.
A	QL2 Head Assembly	EV3063-32
B	OW200L Cartridge	EV9619-01
C	Mounting Screw (2 req'd)	EV3061-96
D	Star Washer (2 req'd)	EV3062-04
E	Flow Control/Quick Disconnect	EV3081-32
F	Mounting Bracket	EV3055-34
G	Bracket Screw (3 req'd)	EV3062-03

SPECIFICATIONS

Rated Service Flow:	0.5 gpm / 1.9 Lpm
Maximum Working Temperature:	35-100°F (2-38°C)
Min/Max Operating Pressure:	10 psi (0.7 bar)/125 psi (8.6 bar)
Capacity:	480 gallons (1816L)
Flow Rate:	0.5 gpm (1.9 Lpm)

For cold water use only.

This drinking water system must be maintained in accordance with the manufacturer's instructions, including the timely replacement of filter cartridges.

INSTALLATION

The following instructions provide for installation of a QL2-OW200L system regardless of whether or not the cooler is already installed. The label on the OW200L cartridge illustrates and explains the procedure for cartridge insertion and removal into the filter head. The filter cartridge should be placed into the head after the system has been installed.

1. Install the QL2-OW200L as close to the cooler as possible. Do not connect this filter to any other equipment. Connect only to the cold water line and do not expose it to high temperatures.
2. Select a location for the filter (nominally 4" x 4" x 22" long including a 2-1/2" drop-down for cartridge changes). Write the installation date and anticipated cartridge replacement date in the space provided on the cartridge label. The cartridge should be replaced every 480 gallons for optimum lead and THM reduction.
3. If required, shut off the incoming water supply and relieve pressure in the water line. Cut the tubing, allowing a 4" space for the filter installation between the water supply and the cooler water inlet.
4. Note the arrow in the top of the QL2 head assembly (refer to item "A" on reverse side of page). This indicates the water flow, from left to right. Note that a 3/8" flow control/quick disconnect fitting (E) has been installed in the outlet (right hand) port.
5. Install a fitting (not supplied) into the inlet (left hand) port. **Do not overtighten the fitting.** Use Teflon tape or food grade pipe joint sealant on fittings.
6. Cut the end of the outlet tubing with a sharp knife, making sure the tube end is cut flat. Insert the tube end onto the quick disconnect fitting (E) and push firmly until the tube end bottoms out in the fitting. To remove the tubing, push the gray ring tight against the fitting while pulling the tubing out.
7. Position the QL2 head assembly so that the arrow shown on top of the head corresponds to the direction of water flow and attach the incoming cold water supply to the inlet of the head.
8. Connect the filter outlet to the water cooler inlet line, and secure in place by tightening the compression nuts.
9. Mount the head to the wall or the cabinet using the screws (C) and star washers (D) provided.
10. Install the OW200L cartridge (B) into the head following the instructions on the cartridge label.
11. Turn on the water and check for leaks.
12. Run water through the OW200L cartridge for three minutes at maximum flow to purge the cartridge of air.

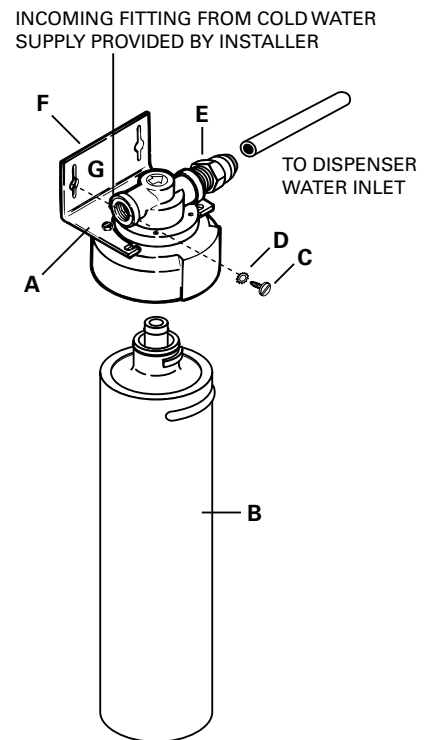



System Tested and Certified by NSF International against NSF/ANSI Standard 42 and 53

Std. No. 42—Aesthetic effects

Chemical Reduction

Taste & Odor

Chlorine

Mechanical Filtration

Particulate Class I

Std. No. 53—Health effects

Chemical Reduction

TTHM

Lead

Mechanical Filtration

Cyst

QUICK-CONNECT FITTING

Insertion & Removal of Plastic or Copper Tubing

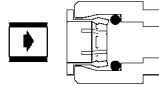

1. Simply push in tube to attach.

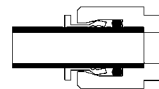

2. Tube is secured in position.

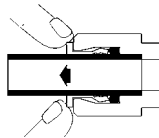

3. Push in collet from both sides to release tubing.

Illustration A
Right Wall
Mounting

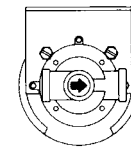
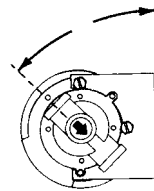
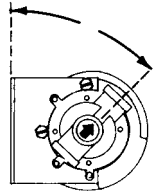

Illustration B
Rear Wall
Mounting

Illustration C
Left Wall
Mounting



Check for compliance with state and local laws and regulations. Do not use with water that is microbiologically unsafe or of unknown quality without adequate disinfection before or after the system. Systems certified for cyst reduction may be used on disinfected waters that may contain filterable cysts.

LIMITED WARRANTY

COMMERCIAL WATER TREATMENT EQUIPMENT

You have just purchased one of the finest water treatment units made. As an expression of our confidence in Everpure products, this product is warranted against defects in material and workmanship to the original end-user when installed in accordance with Everpure specifications. The warranty period commences from the date of purchase and is administered as follows:

For a period of ONE YEAR

Replaceable elements (i.e., filter & water treatment cartridges)*

For a period of FIVE YEARS

The entire system (excluding replaceable elements)

***This is for material & workmanship, not filter or water treatment cartridge life.**

The unit must be used in operating conditions that conform to Everpure's recommended design guidelines. This warranty will not apply if the unit has been modified, repaired or altered by someone not authorized by Everpure.

If a part described above is found defective within the specified period, you should notify Everpure technical service at the phone number listed below. Any part found defective within the terms of this warranty will be repaired or replaced (at Everpure's discretion) by your local dealer or Everpure technical service. You pay only freight from our factory and local dealer charges. Any repaired or replaced warranty item will be incorporated under the original warranty terms of the existing system.

We are not responsible for damage caused by accident, fire, flood, freezing, Act of God, misuse, misapplication, neglect, oxidizing agents (such as chlorine, ozone, chloramines and other related components), alteration, installation or operation contrary to our printed instructions, or by the use of accessories or components which do not meet Everpure's specifications. Refer to the specifications section in the Installation and Operating manual for approved application parameters.

Our product performance specifications are furnished with each water treatment unit. TO THE EXTENT PERMITTED BY LAW, EVERPURE DISCLAIMS ALL IMPLIED WARRANTIES, INCLUDING WITHOUT LIMITATION WARRANTIES OF MERCHANTABILITY AND FITNESS FOR PARTICULAR PURPOSE; TO THE EXTENT REQUIRED BY LAW, ANY SUCH IMPLIED WARRANTIES ARE LIMITED IN DURATION TO THE PERIOD SPECIFIED ABOVE FOR THE ENTIRE WATER TREATMENT UNIT. As a manufacturer, we do not know the characteristics of your water supply or the purpose for which you are purchasing this product. The quality of water supplies may vary seasonally or over a period of time, and your water usage rate may vary as well. Water characteristics can also differ considerably if this product is moved to a new location. For these reasons, we assume no liability for the determination of the proper equipment necessary to meet your requirements, and we do not authorize others to assume such obligations for us. Further, we assume no liability and extend no warranties, express or implied, for the use of this product with a non-potable water source or a water source which does not meet the conditions for use described in the owner's guide or performance data sheet for this product. OUR OBLIGATIONS UNDER THIS WARRANTY ARE LIMITED TO THE REPAIR OR REPLACEMENT (AT EVERPURE'S DISCRETION) OF THE FAILED PARTS OF THE WATER TREATMENT UNIT, AND WE ASSUME NO LIABILITY WHATSOEVER FOR DIRECT, INDIRECT, INCIDENTAL, CONSEQUENTIAL, SPECIAL, GENERAL OR OTHER DAMAGES.

Some states do not allow the exclusion of implied warranties or limitations on how long an implied warranty lasts, so the above limitation may not apply to you. Similarly, some states do not allow the exclusion of incidental or consequential damages, so the above limitation or exclusion may not apply to you. This warranty gives you specific legal rights, and you may also have other rights which vary from state to state. Consult your telephone directory for your local independently operated Everpure dealer, or write Everpure for warranty and service information.

EVERPURE®

For sales, replacement components, and service, contact your Everpure dealer or:

Everpure, LLC: 1040 Muirfield Drive • Hanover Park, Illinois 60133 • 800.323.7873

In Europe: Toekomstlaan 30 • B-2200 Herentals, Belgium

In Japan: Hashimoto MN Bldg. 7F • 3-25-1 Hashimoto Sagami-hara-Shi • Kanagawa 229-1103, Japan

Technical Service

800.942.1153

www.everpure.com

Free Manuals Download Website

<http://myh66.com>

<http://usermanuals.us>

<http://www.somanuals.com>

<http://www.4manuals.cc>

<http://www.manual-lib.com>

<http://www.404manual.com>

<http://www.luxmanual.com>

<http://aubethermostatmanual.com>

Golf course search by state

<http://golfingnear.com>

Email search by domain

<http://emailbydomain.com>

Auto manuals search

<http://auto.somanuals.com>

TV manuals search

<http://tv.somanuals.com>