

# DP DA2

Distribution Amplifier





**Extron Electronics**  
INTERFACING, SWITCHING AND CONTROL

68-2154-01 Rev. C  
07 14

# Safety Instructions

## Safety Instructions • English

**WARNING:** This symbol, , when used on the product, is intended to alert the user of the presence of uninsulated dangerous voltage within the product's enclosure that may present a risk of electric shock.

**ATTENTION:** This symbol, , when used on the product, is intended to alert the user of important operating and maintenance (servicing) instructions in the literature provided with the equipment.

For information on safety guidelines, regulatory compliances, EMI/EMF compatibility, accessibility, and related topics, see the Extron Safety and Regulatory Compliance Guide, part number 68-290-01, on the Extron website, [www.extron.com](http://www.extron.com).

## Instructions de sécurité • Français

**AVERTISSEMENT:** Ce pictogramme, , lorsqu'il est utilisé sur le produit, signale à l'utilisateur la présence à l'intérieur du boîtier du produit d'une tension électrique dangereuse susceptible de provoquer un choc électrique.

**ATTENTION:** Ce pictogramme, , lorsqu'il est utilisé sur le produit, signale à l'utilisateur des instructions d'utilisation ou de maintenance importantes qui se trouvent dans la documentation fournie avec le matériel.

Pour en savoir plus sur les règles de sécurité, la conformité à la réglementation, la compatibilité EMI/EMF, l'accessibilité, et autres sujets connexes, lisez les informations de sécurité et de conformité Extron, réf. 68-290-01, sur le site Extron, [www.extron.com](http://www.extron.com).

## Sicherheitsanweisungen • Deutsch

**WARNUNG:** Dieses Symbol , auf dem Produkt soll den Benutzer darauf aufmerksam machen, dass im Inneren des Gehäuses dieses Produktes gefährliche Spannungen herrschen, die nicht isoliert sind und die einen elektrischen Schlag verursachen können.

**VORSICHT:** Dieses Symbol , auf dem Produkt soll dem Benutzer in der im Lieferumfang enthaltenen Dokumentation besonders wichtige Hinweise zur Bedienung und Wartung (Instandhaltung) geben.

Weitere Informationen über die Sicherheitsrichtlinien, Produkthandhabung, EMI/EMF-Kompatibilität, Zugänglichkeit und verwandte Themen finden Sie in den Extron-Richtlinien für Sicherheit und Handhabung (Artikelnummer 68-290-01) auf der Extron-Website, [www.extron.com](http://www.extron.com).

## Instrucciones de seguridad • Español

**ADVERTENCIA:** Este símbolo, , cuando se utiliza en el producto, avisa al usuario de la presencia de voltaje peligroso sin aislar dentro del producto, lo que puede representar un riesgo de descarga eléctrica.

**ATENCIÓN:** Este símbolo, , cuando se utiliza en el producto, avisa al usuario de la presencia de importantes instrucciones de uso y mantenimiento recogidas en la documentación proporcionada con el equipo.

Para obtener información sobre directrices de seguridad, cumplimiento de normativas, compatibilidad electromagnética, accesibilidad y temas relacionados, consulte la Guía de cumplimiento de normativas y seguridad de Extron, referencia 68-290-01, en el sitio Web de Extron, [www.extron.com](http://www.extron.com).

## Инструкция по технике безопасности • Русский

**ПРЕДУПРЕЖДЕНИЕ:** Данный символ, , если указан на продукте, предупреждает пользователя о наличии неизолированного опасного напряжения внутри корпуса продукта, которое может привести к поражению электрическим током.

**ВНИМАНИЕ:** Данный символ, , если указан на продукте, предупреждает пользователя о наличии важных инструкций по эксплуатации и обслуживанию в руководстве, прилагаемом к данному оборудованию.

Для получения информации о правилах техники безопасности, соблюдении нормативных требований, электромагнитной совместимости (ЭМП/ЭДС), возможности доступа и других вопросах см. руководство по безопасности и соблюдению нормативных требований Extron на сайте Extron: [www.extron.com](http://www.extron.com), номер по каталогу - 68-290-01.

## Chinese Simplified (简体中文)

**警告:**  产品上的这个标志意在警告用户该产品机壳内有暴露的危险电压, 有触电危险。

**注意:**  产品上的这个标志意在提示用户设备随附的用户手册中有重要的操作和维护(维修)说明。

关于我们产品的安全指南、遵循的规范、EMI/EMF 的兼容性、无障碍使用的特性等相关内容, 敬请访问 Extron 网站 [www.extron.com](http://www.extron.com), 参见 Extron 安全规范指南, 产品编号 68-290-01。

## Chinese Traditional (繁體中文)

**警告:**  若產品上使用此符號, 是為了提醒使用者, 產品機殼內存在著可能會導致觸電之風險的未絕緣危險電壓。

**注意:**  若產品上使用此符號, 是為了提醒使用者, 設備隨附的用戶手冊中有重要的操作和維護(維修)說明。

有關安全性指導方針、法規遵守、EMI/EMF 相容性、存取範圍和相關主題的詳細資訊, 請瀏覽 Extron 網站: [www.extron.com](http://www.extron.com), 然後參閱《Extron 安全性與法規遵守手冊》, 準則編號 68-290-01。

## Japanese

**警告:** この記号  が製品上に表示されている場合は、筐体内に絶縁されていない高電圧が流れ、感電の危険があることを示しています。

**注意:** この記号  が製品上に表示されている場合は、本機の取扱説明書に記載されている重要な操作と保守(整備)の指示についてユーザーの注意を喚起するものです。

安全上のご注意、法令遵守、EMI/EMF適合性、その他の関連項目については、エクストロンのウェブサイト [www.extron.com](http://www.extron.com) より『Extron Safety and Regulatory Compliance Guide』(P/N 68-290-01)をご覧ください。

## Korean

**경고:** 이 기호  가 제품에 사용될 경우, 제품의 인클로저 내에 있는 접지되지 않은 위험한 전류로 인해 사용자가 감전될 위험이 있음을 경고합니다.

**주의:** 이 기호  가 제품에 사용될 경우, 장비와 함께 제공된 책자에 나와 있는 주요 운영 및 유지보수(정비) 지침을 경고합니다.

안전 가이드라인, 규제 준수, EMI/EMF 호환성, 접근성, 그리고 관련 항목에 대한 자세한 내용은 Extron 웹 사이트([www.extron.com](http://www.extron.com))의 Extron 안전 및 규제 준수 안내서, 68-290-01 조항을 참조하십시오.

## FCC Class A Notice

This equipment has been tested and found to comply with the limits for a Class A digital device, pursuant to part 15 of the FCC rules. The Class A limits provide reasonable protection against harmful interference when the equipment is operated in a commercial environment. This equipment generates, uses, and can radiate radio frequency energy and, if not installed and used in accordance with the instruction manual, may cause harmful interference to radio communications. Operation of this equipment in a residential area is likely to cause interference. This interference must be corrected at the expense of the user.

### NOTE:

- This unit was tested with shielded I/O cables on the peripheral devices. Shielded cables must be used to ensure compliance with FCC emissions limits.
- For more information on safety guidelines, regulatory compliances, EMI/EMF compatibility, accessibility, and related topics, see the [Extron Safety and Regulatory Compliance Guide](#) on the Extron website.

### Copyright

© 2014 Extron Electronics. All rights reserved.

### Trademarks

All trademarks mentioned in this guide are the properties of their respective owners.

**The following registered trademarks<sup>®</sup>, registered service marks<sup>SM</sup>, and trademarks<sup>TM</sup> are the property of RGB Systems, Inc. or Extron Electronics:**

Registered Trademarks <sup>®</sup>
AVTrac, Cable Cubby, CrossPoint, eBUS, EDID Manager, EDID Minder, Extron, Flat Field, GlobalViewer, Hideaway, Inline, IP Intercom, IP Link, Key Minder, LockIt, MediaLink, PlenumVault, PoleVault, PowerCage, PURE3, Quantum, SoundField, SpeedMount, SpeedSwitch, System INTEGRATOR, TeamWork, TouchLink, V-Lock, VersaTools, VN-Matrix, VoiceLift, WallVault, WindoWall, XTP, XTP Systems
<b>Registered Service Mark<sup>SM</sup> :</b> S3 Service Support Solutions
Trademarks <sup>TM</sup>
AAP, AFL (Accu-Rate Frame Lock), ADSP (Advanced Digital Sync Processing), Auto-Image, CableCover, CDRS (Class D Ripple Suppression), DDSP (Digital Display Sync Processing), DMI (Dynamic Motion Interpolation), Driver Configurator, DSP Configurator, DSVP (Digital Sync Validation Processing), EQIP, FastBite, FOXBOX, Global Configurator, IP Intercom HelpDesk, LinkLicense, MAAP, MicroDigital, ProDSP, QS-FPC (QuickSwitch Front Panel Controller), Scope-Trigger, SIS, Simple Instruction Set, Skew-Free, SpeedNav, Triple-Action Switching, XTRA, ZipCaddy, ZipClip

## Conventions Used in this Guide

### Notifications

In this user guide, the following are used:

**WARNING:** Potential risk of severe injury or death.

**AVERTISSEMENT:** Risque potentiel de blessure grave ou de mort.

**CAUTION:** Risk of minor personal injury.

**ATTENTION:** Risque de blessure mineure.

**ATTENTION:**

- Risk of property damage.
- Risque de dommages matériels.

**NOTE:** A note draws attention to important information.

### Software Commands

Commands are written in the fonts shown here:

```
^AR Merge Scene, ,Op1 scene 1,1 ^B 51 ^W ^C
```

```
[ 01 ] R 0004 00300 00400 00800 00600 [ 02 ] 35 [ 17 ] [ 03 ]
```

```
Esc [X1]*[X17]*[X20]*[X23]*[X21]CE ←
```

**NOTE:** For commands and examples of computer or device responses mentioned in this guide, the character “Ø” is used for the number zero and “O” represents the capital letter “o”.

Computer responses and directory paths that do not have variables are written in the font shown here:

```
Reply from 208.132.180.48: bytes=32 times=2ms TTL=32
```

```
C:\Program Files\Extron
```

Variables are written in slanted form as shown here:

```
ping xxx.xxx.xxx.xxx -t
```

```
SOH R Data STX Command ETB ETX
```

Selectable items, such as menu names, menu options, buttons, tabs, and field names are written in the font shown here:

From the **File** menu, select **New**.

Click the **OK** button.

## Specifications Availability

Product specifications are available on the Extron website, [www.extron.com](http://www.extron.com).

# Contents

---

<b>Introduction.....</b>	<b>1</b>
About the DP DA2.....	1
DP DA2 Features.....	1
Application Diagram .....	2

---

<b>Panel Features.....</b>	<b>3</b>
Rear Panel.....	3
Front Panel.....	3
Rear Panel Features .....	4
Power Supply .....	4
Display Port Connectors .....	6
Dual Mode DisplayPort .....	7
EDID Minder .....	7
RS-232 Control .....	9
Mute Control.....	9
Front Panel Features.....	10
Power LED .....	10
Config USB Port .....	10
Signal and HDCP LEDs .....	12

---

<b>Setup.....</b>	<b>13</b>
-------------------	-----------

---

<b>SIS Commands .....</b>	<b>14</b>
Introduction to SIS .....	14
Symbols Used in this Guide.....	15
Error Messages .....	15
Command and Response Table for SIS Commands .....	16

---

<b>Updating Firmware.....</b>	<b>18</b>
Downloading and Installing Firmware Loader ....	18
Downloading DP DA2 Firmware.....	19
Loading the Firmware to the DP DA2.....	20
Resetting Firmware to the Factory Default Version.....	23

---

<b>Mounting .....</b>	<b>24</b>
Desktop Placement .....	24
Rack Mounting .....	24
UL Guidelines for Rack Mounting.....	24
Rack Mounting Procedure .....	24



# Introduction

This guide describes the function, installation and operation of the DP DA2 distribution amplifier. Unless otherwise stated, the terms “DA” and “distribution amplifier” refer to the DP DA2.

This section contains the following information:

- [About the DP DA2](#)
- [DP DA2 Features](#)
- [Application Diagram](#)

## About the DP DA2

The DP DA2 provides an Extron distribution amplifier for VESA® DisplayPort signals. It accepts a single input with data rates up to 10.8 Gbps and, in normal mode, distributes two identical outputs with resolutions of up to 2560x1600 @ 60 Hz on each output. Input and output signals can each be carried a maximum of 25 feet (7.62 m).

In Extend mode, the DP DA2 outputs an image with a resolution of up to 3840x1080 @ 60 Hz extended over two output displays.

The DP DA2 uses the DisplayPort v1.1a standard and is backwards compatible with earlier specifications. It has EDID Minder for EDID management, Key Minder for continuous HDCP verification, and can be controlled by RS-232, using the Extron Simple Instruction Set (SIS) commands.

## DP DA2 Features

**DisplayPort** — In normal mode provides two identical outputs with PC resolutions up to 2560x1600 @ 60 Hz, with multi-channel audio and HDTV up to 1080p @ 60 Hz, distributed with embedded multi-channel digital audio signals.

**Thunderbolt™ source support (input)** — Thunderbolt sources are backward compatible with the DP DA2 input with respect to both audio and video. Thunderbolt devices are not supported on the DP DA2 outputs.

**Signals up to 10.8 Gbps** — Supports data rates of either 1.62 Gbps (reduced bit rate) or 2.7 Gbps (high bit rate) using one, two, or four lanes.

**Dual mode** — Allows for interoperability with HDMI, DVI, and VGA display devices. Provides connectivity between a dual mode DisplayPort-equipped source and HDMI, DVI, and VGA display devices with an appropriate adapter.

**Extend mode** — Outputs a single image with a resolution of up to 3840x1080 @ 60 Hz extended over two output displays.

**EDID Minder** — Maintains continuous EDID (Extended Display Identification Data) communication with the attached source. This ensures that the source powers up correctly and maintains a proper video output, even if the display is off.

**Content protection** — Supports High-bandwidth Digital Content Protection (HDCP). The DP DA2 checks the source and output displays for HDCP compliance.

**HDCP visual confirmation** — Provides a green signal when encrypted content is sent to a non-compliant display. A full-screen green signal is sent when HDCP-encrypted content is transmitted to a non-HDCP compliant display, providing immediate visual confirmation that protected content cannot be viewed on the display.

**Key Minder** — Authenticates and maintains continuous HDCP encryption between all input and output devices to enable simultaneous distribution of a single source signal to two or more displays.

**Automatic input cable equalization** — Up to 25 feet (7.6 m) at 2560x1600 @ 60 Hz with Extron DisplayPort cables. Conditions incoming digital signals to compensate for signal loss from long cables, low quality cables, or source devices with poor DisplayPort signal output.

**LED indicators** — Provide real-time feedback and monitoring of key performance parameters by indicating signal presence and HDCP authentication. The tri-color EDID LED indicator on the back panel shows whether an internal or external EDID is stored.

**RS-232 serial control** — Allows control by SIS commands either via the controller or directly from a PC using the front panel USB port or the rear panel 3-pole captive screw connector.

**Output muting control via RS-232 or contact closure** — Provides the capability to mute one or both outputs at any time. This allows content to be viewed on a local monitor prior to appearing on the main presentation display.

## Application Diagram

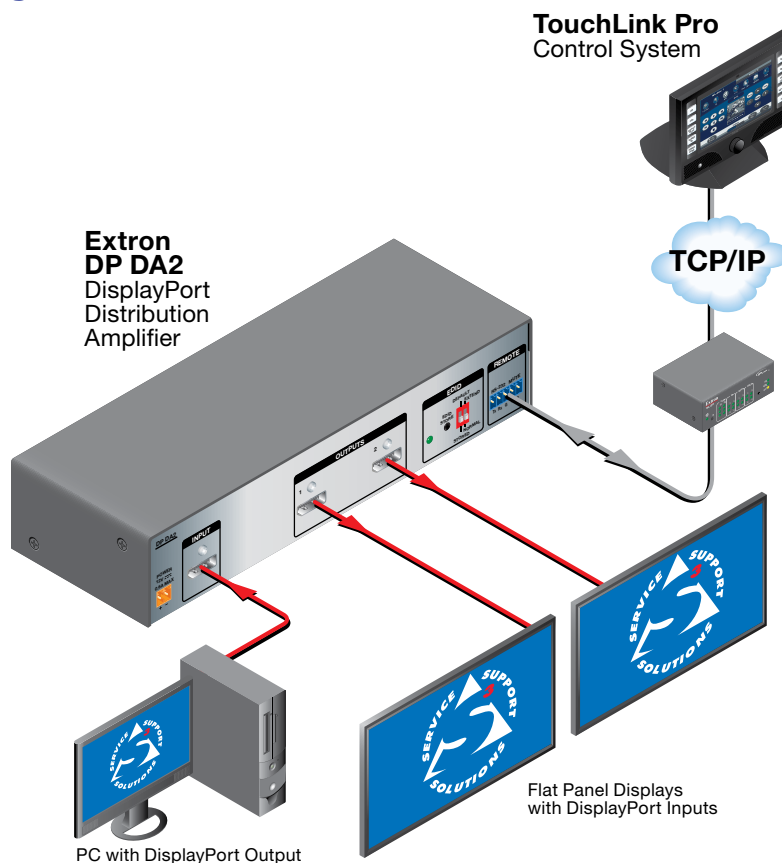

**Figure 1.** Typical DP DA2 Application



# Panel Features

This section describes the panel features and connections of the DP DA2.

## Rear Panel

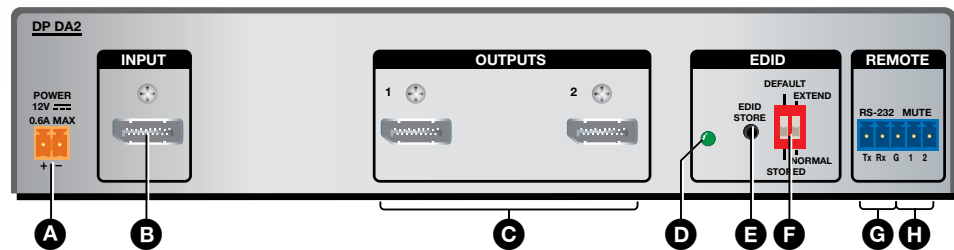

**Figure 2.** DP DA2 Rear Panel

- A Power** — Connect the provided power supply to this 2-pole, 3.5 mm captive screw connector.
- B Input** — Connect the source device to this female DisplayPort connector.
- C Outputs** — Connect up to two display devices to these female DisplayPort connectors.
- D EDID Minder LED** — Lights red, amber, or green, showing current EDID Minder state.
- E EDID Minder Store push button** — This recessed button activates EDID store.
- F EDID Minder DIP switches** — Used to configure the EDID Minder features.
- G RS-232 control** — Connect the transmit (Tx), receive (Rx), and ground (G) connectors of this 5-pole, 3.5 mm captive screw connector to a control PC.
- H Mute control** — Connect the ground (G) and either pin 1 (to mute output 1) or pin 2 (to mute channel 2).

## Front Panel



**Figure 3.** DP DA2 Front Panel

- A Power LED** — Lights green when the unit is receiving power.
- B Config USB port** — Connect this USB port to a control PC.
- C Signal and HDCP LEDs** — Provide information about the signal and HDCP encryption status of the input and outputs.

## Rear Panel Features

### Power Supply

The provided 12 VDC power supply connects to this 2-pole, 3.5 mm captive screw connector. The front panel power LED lights green when the unit is receiving power.

1. Connect the captive screw connector from the power supply to the power receptacle.

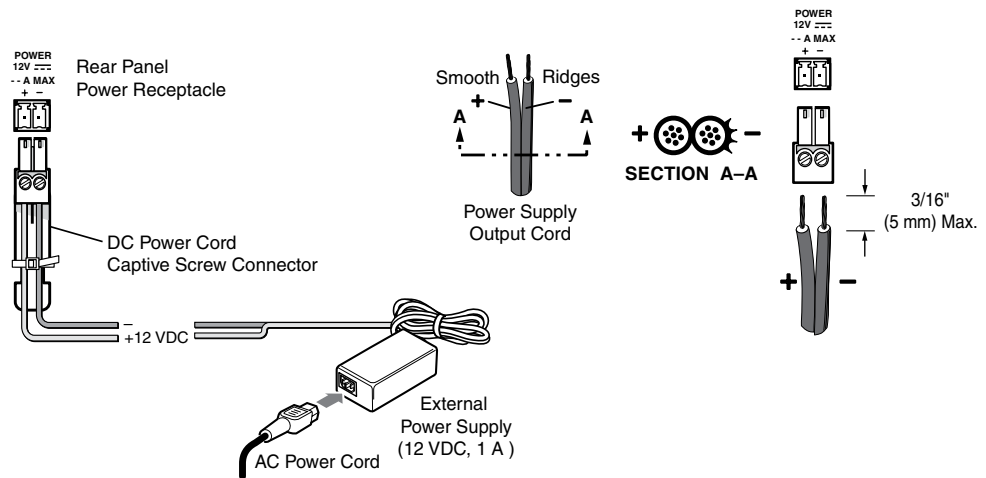

**Figure 4. Power Connections**

#### ATTENTION:

- Always use a power supply provided by or specified by Extron. Use of an unauthorized power supply voids all regulatory compliance certification and may cause damage to the supply and the end product.
- Utilisez toujours une source d'alimentation fournie ou recommandée par Extron. L'utilisation d'une source d'alimentation non autorisée annule toute conformité réglementaire et peut endommager la source d'alimentation ainsi que le produit final.
- These products are intended for use with a UL Listed power source marked "Class 2" or "LPS" and rated 12 VDC, minimum 1.0 A. or 48 VDC (PoE), minimum 0.35 A.
- Ces produits sont destinés à une utilisation avec une source d'alimentation listée UL avec l'appellation « Classe 2 » ou « LPS » et normée 12 Vcc, 1,0 A minimum ou 48 Vcc (PoE), 0,35 A minimum.
- Extron power supplies are certified to UL/CSA 60950-1 and are classified as LPS (Limited Power Source). Use of a non-LPS or unlisted power supply will void all regulatory compliance certification.
- Les sources d'alimentation Extron sont qualifiées UL/CSA 60950-1 et sont classées LPS (Limited Power Source). L'utilisation d'une source d'alimentation non-listée ou non-listée LPS annulera toute certification de conformité réglementaire.

**ATTENTION:**

- Unless otherwise stated, the AC/DC adapters are not suitable for use in air handling spaces or in wall cavities. The power supply is to be located within the same vicinity as the Extron AV processing equipment in an ordinary location, Pollution Degree 2, secured to the equipment rack within the dedicated closet, podium, or desk.
- Sauf mention contraire, les adaptateurs AC/DC ne sont pas appropriés pour une utilisation dans les espaces d'aération ou dans les cavités murales. La source d'alimentation doit être située à proximité de l'équipement de traitement audiovisuel dans un endroit ordinaire, avec un degré 2 de pollution, fixé à un équipement de rack à l'intérieur d'un placard, d'une estrade, ou d'un bureau.
- The installation must always be in accordance with the applicable provisions of National Electrical Code ANSI/NFPA 70, article 725 and the Canadian Electrical Code part 1, section 16.
- Cette installation doit toujours être en accord avec les mesures qui s'applique au National Electrical Code ANSI/NFPA 70, article 725, et au Canadian Electrical Code, partie 1, section 16.
- The power supply shall not be permanently fixed to building structure or similar structure.
- La source d'alimentation ne devra pas être fixée de façon permanente à une structure de bâtiment ou à une structure similaire.
- Power supply voltage polarity is critical. Incorrect voltage polarity can damage the power supply and the unit. Identify the power cord negative lead by the ridges on the side of the cord (figure 4).
- La polarité de la source d'alimentation est primordiale. Une polarité incorrecte pourrait endommager la source d'alimentation et l'unité. Repérez le pôle négatif du cordon d'alimentation grâce aux stries sur le côté du cordon (illustration 4).
- The length of the exposed wires in the stripping process is critical. The ideal length is 3/16 inches (5 mm). Any longer and the exposed wires may touch, causing a short circuit between them. Any shorter and the wires can be easily pulled out even if tightly fastened by the captive screws.
- La longueur des câbles exposés est primordiale lorsque l'on entreprend de les dénuder. La longueur idéale est de 5 mm (3/16 inches). S'ils sont un peu plus longs, les câbles exposés pourraient se toucher et provoquer un court circuit. S'ils sont un peu plus courts, ils pourraient sortir, même s'ils sont attachés par les vis captives.
- Do not tin the wire leads before installing into the connector. Tinned wires are not as secure in the connector and could be pulled out.
- Ne pas étamer les conducteurs avant de les insérer dans le connecteur. Les câbles étamés ne sont pas aussi bien fixés dans le connecteur et pourraient être retirés.

2. Connect the AC power cord of the power supply unit to a 110 or 220 VAC electrical source. When the unit is receiving power, the front panel LED shows a green light.

## Display Port Connectors

Connect the source device to the input socket and up to two display devices to the output sockets. The connector wiring is shown in the figure and table below.

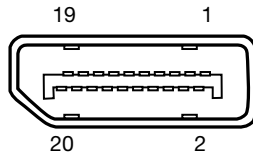

Pin	Function	Notes
1	ML Lane 0 (p)	Main Link Lane 0 (positive)
2	GND	Ground
3	ML_Lane 0 (n)	Main Link Lane 0 (negative)
4	ML_Lane 1 (p)	Main Link Lane 1 (positive)
5	GND	Ground
6	ML_Lane 1 (n)	Main Link Lane 1 (negative)
7	ML_Lane 2 (p)	Main Link Lane 2 (positive)
8	GND	Ground
9	ML_Lane 2 (n)	Main Link Lane 2 (negative)
10	ML_Lane 3 (p)	Main Link Lane 3 (positive)
11	GND	Ground
12	ML_Lane 3 (n)	Main Link Lane 3 (negative)
13	CONFIG1	Connected to Ground 1
14	CONFIG2	Connected to Ground 1
15	AUX CH (p)	Auxiliary Channel (positive)
16	GND	Ground
17	AUX CH (n)	Auxiliary Channel (negative)
18	Hot Plug	Hot Plug Detect
19	Return	Return for Power
20	DP_PWR	Power for adapters (3.3 V 500 mA)

The DP DA2 supports data rates of either 1.62 Gbps (reduced bit rate) or 2.7 Gbps (high bit rate), using either one, two, or four lanes. The DP DA2 supports mini DisplayPort and dual mode DisplayPort through the use of the appropriate adapters and cables (not provided).

An equalizer on the input compensates for a poor source signal and allows a cable run of up to 25 feet (7.62 m).

The DP DA2 supports resolutions up to 2560x1600 @ 60 Hz. In addition, a resolution of 3840x1080 @ 60 Hz can be carried over two outputs and displayed as extended view. If audio is available from the source, it will also be available to the output devices.

The Key Minder feature ensures that the DP DA2 is fully HDCP compliant. The source negotiates with the DP DA2 input and the display negotiates with the DP DA2 output. The input HDCP LED lights green when the source is encrypted and has been authenticated by the DP DA2 unit. Each output HDCP LED lights green when HDCP has been authenticated between the source and the corresponding output. The LEDs will not light if the source does not require HDCP encryption or if the sink device connected to that output is not HDCP compliant.

**NOTE:** Extron recommends that the displays connected to outputs 1 and 2 are the same model or have the same native resolution.

## Dual Mode DisplayPort

The DP DA2 supports dual mode for interoperability with VGA, DVI, and HDMI display devices. Appropriate adapters are required.

### NOTES:

- Certain VGA displays that lack a scaler do not work properly with Dual Mode DisplayPort.
- In some applications using DisplayPort adapters, the DP DA2 may be unable to capture EDID of the display connected to output 1. Use SIS commands to adjust the DDC speed (see page 15).

## EDID Minder

During boot up, the source device uses the auxiliary channel to obtain Extended Display Identification Data (EDID) from the display device. This allows the output signal to match the resolution and refresh rate of the display device.

EDID Minder allows the user to store and use EDID values for another display device to ensure the output signal is compatible with both the display devices.

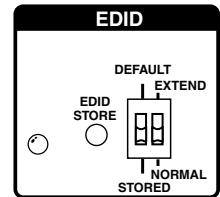

### EDID Store push button and LED

#### Recording EDID

1. Connect the display device that will provide EDID information to output 1.
2. Power on the display and the DP DA2.
3. Set DIP switch 1 in the Stored (down) position (see [DIP Switches](#) on the following page for more information). The EDID Minder LED lights red until you start recording EDID.
4. Press the EDID Store push button. The button is recessed (you may need a small screw driver).

The EDID Minder LED lights amber while the EDID is being stored and turns green when the recording process is successfully completed.

EDID information is read from the display device connected to output 1. The recorded EDID is stored in non-volatile memory and is retained after a power cycle or after a new display device is connected to output 1.

The new EDID is then available with DIP switch 1 is in the Stored position. Each time a new EDID is recorded, it overwrites the existing data and is available when DIP switch 1 is in the Stored position.

**NOTE:** If the EDID for a display device is corrupted or cannot be read, the DP DA2 will continue to use the currently stored EDID.

#### EDID Minder LED

The LED shows the status of the EDID recording process:

- **Off** — DIP switch 1 is set to Default.
- **Red** — DIP switch 1 is set to Stored, but external EDID has not been stored (the factory default EDID is still present).
- **Amber** — New EDID information is currently being read and stored.
- **Green** — External EDID has been stored.

## DIP switches

Two DIP switches are used to select which of two EDID values is presented to the source device (DIP switch 1) and whether the output is in normal or extend mode (DIP switch 2).

**DIP switch 1** — In the Default (up) position, the EDID value is the factory-stored default, with a native resolution of 1080p and 2-channel audio. In the Stored (down) position, the most recently recorded EDID value is used (this file overwrites previously stored values). Before any other EDID file is recorded, the factory default EDID is also stored here.

To record EDID, follow the instructions in [Recording EDID](#) on the previous page.

**DIP switch 2** — In the Normal (down) position, the DP DA2 provides two duplicate outputs of up to 2560x1600 @ 60Hz and multi-channel audio. If the DIP switch is in the Extend (up) position, the DP DA2 provides an image with a resolution of up to 3840x1080 @ 60 Hz and 2-channel audio extended over two output displays.

Available Extend Mode Resolutions	Resolution per Output
3840x1080 @ 60 Hz	1920x1080 @ 60 Hz
3360x1050 @ 60 Hz	1680x1050 @ 60 Hz
2880x900 @ 60 Hz	1440x900 @ 60 Hz
2560x1024 @ 60 Hz	1280x1024 @ 60 Hz

## Summary

DIP Switch 1	DIP Switch 2	Function
Stored (down)	Normal (down)	Stored EDID is used and normal mode
Default (up)	Normal (down)	Default EDID is used and normal mode
	Extend (up)	Extended mode

**NOTE:** If DIP switch 2 is set to Extend, DIP switch 1 is non-functional

## RS-232 Control

The RS-232 controls use the first three pins of the rear panel 5-pin captive screw connector labeled “Remote”. The pins are labeled Tx, Rx, and G. The ground (G) is shared with the mute controls.

Connect the DP DA2 to a control PC, as follows:

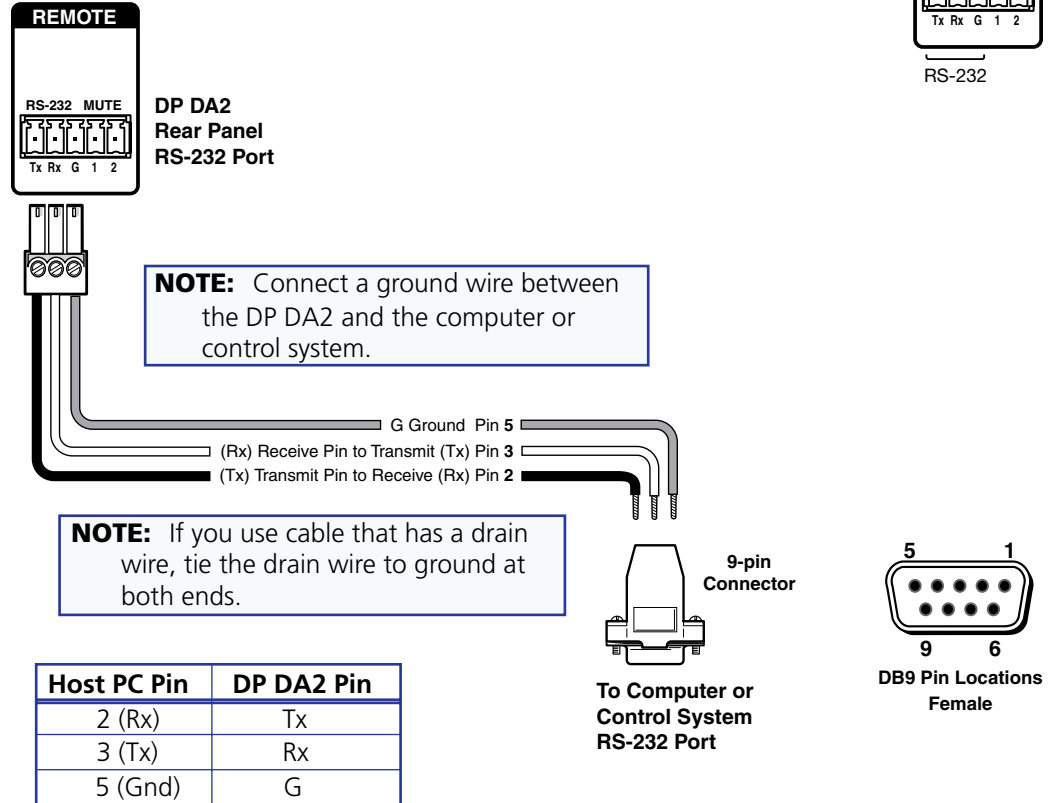

Alternatively, use the Config USB port to connect to the PC (see the next page). For complete information about SIS commands, see [SIS Commands](#) on page 14.

## Mute Control

The mute controls use the third, fourth, and fifth pins of the “Remote” 5-pin captive screw connector. They are labeled G, 1, and 2. The ground (G) is shared with the RS-232.

Ground pin 1 (to mute output 1) or pin 2 (to mute output 2).

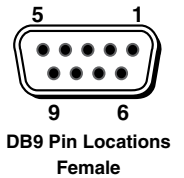
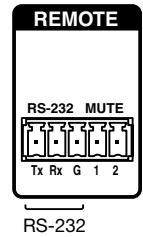

## Front Panel Features

### Power LED

The Power LED lights green when the unit is receiving power.

### Config USB Port

#### Connecting to the USB Port

The mini type B USB port is located on the DP DA2 front panel. It can be used to connect the distribution amplifier to a host computer for updating firmware or for configuration using SIS commands. Alternatively, use the **RS-232 captive screw connector** (see page 9). For complete information about SIS commands, see **SIS Commands** on page 14.

1. Connect a USB A to mini B cable between the USB Config port on the front panel of the DP DA2 and the USB port of the PC.

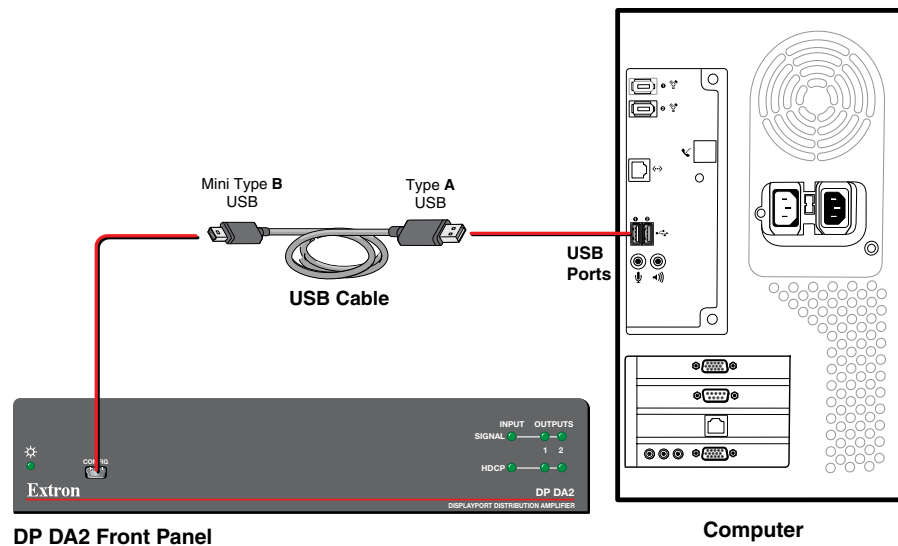

**Figure 5. Connecting a PC to the DP DA2 Front Panel USB Port**

2. If this is the first time a DP DA2 has been connected to the PC, the Found New Hardware Wizard opens. The first screen offers to search the web for the appropriate driver needed to communicate with the distribution amplifier via the USB port. This is not necessary if the USB driver is already on your PC.



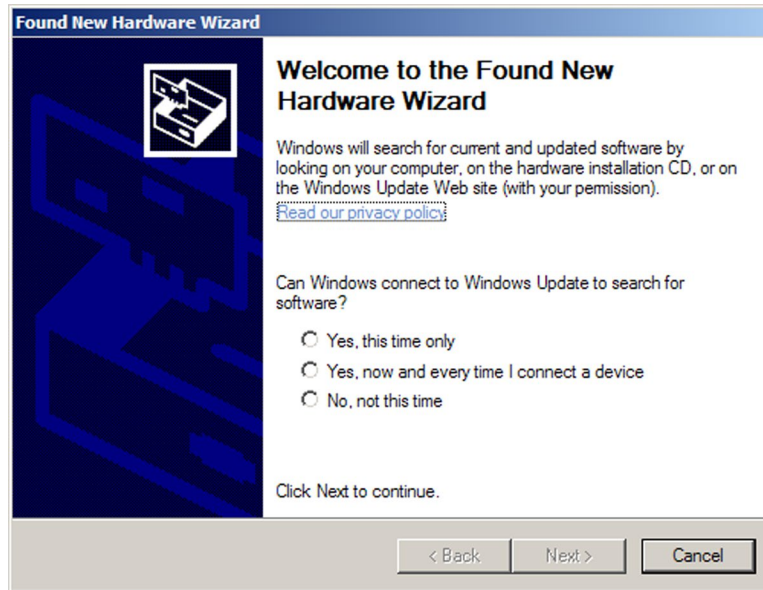

**Figure 6. Found New Hardware Wizard Welcome Screen**

- Select **Yes, this time only** to connect the PC to Windows Update only this one time.
  - Select **Yes, now, and every time I connect a device** to automatically connect to Windows Update every time the DP DA2 connects to this USB port.
  - Select **No, not this time** if you do not want to connect to Windows Update (for example, if the driver is already on the PC).
3. Click **Next**. The next screen of the Wizard opens unless **No, not this time** was selected in step 2:

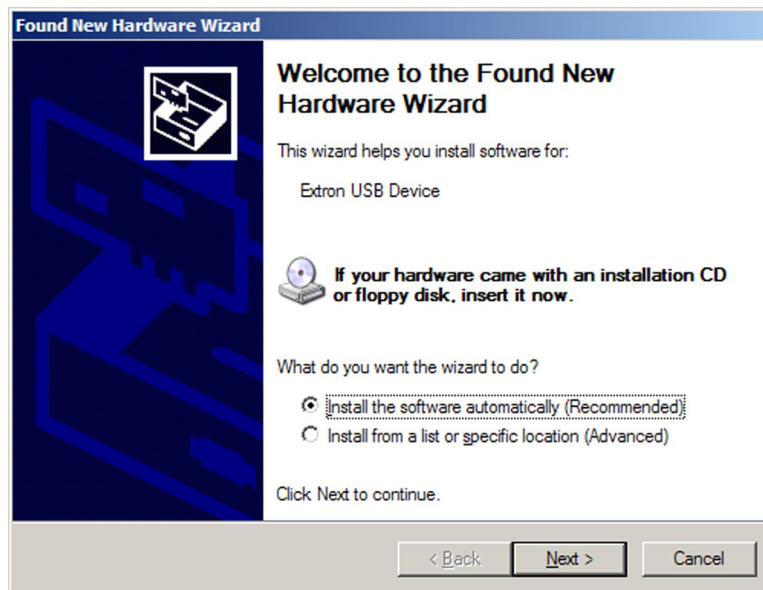

**Figure 7. Installing the Software Automatically**

4. Select **Install the software automatically (Recommended)** and click **Next**.

**NOTE:** You do not need to insert an installation disc.

The PC locates the driver needed and installs it in the correct location on the hard drive.

5. When the Completed screen appears, click **Finish** to close the wizard.

**NOTE:** The wizard appears only on the first occasion you connect the DP DA2 to that USB port. The wizard will reappear if you connect the DP DA2 to a different USB port or if you connect a different piece of equipment, requiring a different driver, to the same USB port.

6. Configure the DP DA2 as required.

## Signal and HDCP LEDs

### Signal LEDs

**Input Signal LED** — Lights green when main link activity is detected from the source device connected to the input.

**Output Signal LED** — Lights green when a main link signal is being transmitted to at least one of the display devices connected to the outputs.

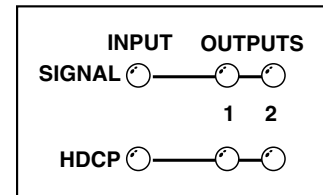

### HDCP LEDs

**Input HDCP LED** — Lights green when the source is HDCP encrypted and authenticated by the DP DA2.

**Output HDCP LED** — Lights green when the connected display device is HDCP compliant.

**NOTE:** The HDCP LEDs will not light if the source device does not require HDCP encryption or if the display devices are not HDCP compliant.

# Setup

This section provides an overview of how to connect and configure the DP DA2.

1. Place the DP DA2 in a suitable location.
2. If necessary, connect the DP DA2 to a control PC using either the **rear panel RS-232 captive screw connector** (see page 9) or the **front panel USB mini B connector** (see page 10).
3. **Power on the DP DA2** (see page 4) and the PC and configure the DP DA2 as required, **using SIS commands** (see page 16).
4. **Connect up to two display devices** to the rear panel output connectors (see page 6). **To record EDID** (see page 7), the display with the lowest resolution should be connected to output 1.

#### NOTES:

- Both display devices must have resolution equal to or higher than the EDID values being used.
- Extron recommends that the displays connected to outputs 1 and 2 are the same model or have the same native resolution.

5. Power on the display devices.
6. If necessary, **record the EDID** from the device connected to output 1 (see page 7).
7. Select the correct **settings for DIP switches** 1 and 2 (see page 8).
8. Connect the source device to the **rear panel input connector** (see page 6).
9. Power on the source device.

# SIS Commands

This section provides information about the Extron Simple Instruction Set (SIS™) commands that are used to configure the DP DA2.

- [Introduction to SIS](#)
- [Symbols Used in this Guide](#)
- [Error Messages](#)
- [Command and Response Table for SIS Commands](#)

## Introduction to SIS

The DP DA2 accepts SIS commands from a host device such as a computer running the Extron DataViewer utility or other control system. The host device can be connected to the 3-pin captive screw connector on the rear panel or to the config port on the front panel. To connect to the config port, use the optional Extron USB CFG cable.

The protocol is 9600 baud, 8 data bits, 1 stop bit, and no parity.

### NOTES:

- The wiring in the RS-232 cables crosses over so that the DP DA2 Tx connects with the control device Rx and vice versa.
- Only one serial port can be used at a time. If the config port is in use, the rear captive screw connector must be disconnected from the computer or other control device. Likewise, if the captive screw port is in use, the config port on the front panel must be disconnected from the computer or other control device.

SIS commands consist of a string (one or more characters per command field). Unless otherwise stated, upper and lower case characters may be used interchangeably. Commands do not require any special characters to begin or end the command string. Each response from the DP DA2 ends with a carriage return and a line feed (CR/LF = ) which signals the end of the response character string.

When the DP DA2 is first switched on, it sends the message:

(c) Copyright 2012, Extron Electronics DisplayPort DA Series, V x.xx, 60-1221-01] where 60-1221-01 is the catalog part number and V x.xx is the firmware version number.

## Symbols Used in this Guide

When programming in the field, certain characters are conveniently represented by their hexadecimal rather than their ASCII values. The table below shows the hexadecimal equivalent of each ASCII character:

ASCII to HEX Conversion Table										Esc	1B	CR	0D	LF	0A
Space	20	!	21	"	22	#	23	\$	24	%	25	&	26	'	27
(	28	)	29	*	2A	+	2B	,	2C	-	2D	.	2E	/	2F
0	30	1	31	2	32	3	33	4	34	5	35	6	36	7	37
8	38	9	39	:	3A	;	3B	<	3C	=	3D	>	3E	?	3F
@	40	A	41	B	42	C	43	D	44	E	45	F	46	G	47
H	48	I	49	J	4A	K	4B	L	4C	M	4D	N	4E	O	4F
P	50	Q	51	R	52	S	53	T	54	U	55	V	56	W	57
X	58	Y	59	Z	5A	[	5B	\	5C	]	5D	^	5E	_	5F
,	60	a	61	b	62	c	63	d	64	e	65	f	66	g	67
h	68	i	69	j	6A	k	6B	l	6C	m	6D	n	6E	o	6F
p	70	q	71	r	72	s	73	t	74	u	75	v	76	w	77
x	78	y	79	z	7A	{	7B		7C	}	7D	~	7E	DEL	7F

**Table 1. ASCII to HEX Conversion Table**

- ↵ — Carriage return with line feed
- ← — Carriage return (no line feed)
- — Space character
- Esc** — Escape key

The **xn** values defined in this section are the variables used in the fields of the command response table on the next page.

- x1** — Video output (1 or 2)
- x2** — Status
  - 0 = disabled, off, or undetected
  - 1 = enabled, on, or detected
- x3** — 1 = default; 2 = stored; 3 = extend
- x4** — 256 bytes of raw hex data
- x5** — Native resolution and refresh rate (translated from HEX)
- x6** — Controller software version to the second decimal place
- x7** — Unit name. This is a text string up to 24 characters drawn from the alphabet (A-Z), digits (0-9), minus sign/hyphen (-). No blank or space characters are permitted as part of a name. No distinction is made between upper and lower case. The first character must be an alpha character. The last character must not be a minus sign (hyphen).
- x8** — DDC speed: 1 = Low (20 kbits; default) 2 = High (100 kbits)
- x9** — Video bit depth: 0 = Auto (default) 1 = 8 bit. Auto follows the capabilities of the source and the display connected to the output.

## Error Messages

- E01 — Invalid input channel number (too large)
- E10 — Invalid command
- E13 — Invalid value (too large)
- E14 — Not valid for this configuration

## Command and Response Table for SIS Commands

Command	ASCII Command (host to unit)	Response (unit to host)	Additional Description
<b>Video Mute</b>			
Video mute single output	<b>X1</b> * <b>X2</b> B	Vmt <b>X1</b> * <b>X2</b> ↵	Set video mute status ( <b>X2</b> ) for output ( <b>X1</b> ).
Video mute all outputs	<b>X2</b> B	Vmt <b>X2</b> ↵	
Query video mute status	B	Vmt <b>X2</b> • <b>X2</b> ↵	
<b>Audio Mute</b>			
Audio mute single output	<b>X1</b> * <b>X2</b> Z	Amt <b>X1</b> * <b>X2</b> ↵	Set audio mute status ( <b>X2</b> ) for output ( <b>X1</b> ).
Audio mute all outputs	<b>X2</b> Z	Amt <b>X2</b> ↵	
Query audio mute status	Z	Amt <b>X2</b> • <b>X2</b> ↵	
<b>Signal Status</b>			
Request all signal status	<b>Esc</b> LS↵	Sig <b>X2</b> * <b>X2</b> • <b>X2</b> ↵	input signal status * output 1 signal status • output 2 signal status ∅ = signal undetected; 1 = signal detected
<b>HDCP</b>			
HDCP authorized device on	<b>Esc</b> E1HDCP↵	HdcpE1↵	HDCP authorized device is on.
HDCP authorized device off	<b>Esc</b> E∅HDCP↵	HdcpE∅↵	HDCP authorized device is off.
Request HDCP authorized device status	<b>Esc</b> EHDCP↵	<b>X2</b> ↵	HDCP status (1 = on; ∅ = off)
<b>EDID Minder</b>			
View EDID assignment	<b>Esc</b> A*EDID↵	<b>X3</b> ↵	
View/Read EDID in HEX	<b>Esc</b> R*EDID↵	<b>X4</b> ↵	Read up to 256 bytes of HEX (as text) from currently selected EDID
View EDID native resolution	<b>Esc</b> N*EDID↵	<b>X5</b> ↵	From current EDID selection for example: 1600x1200 @ 60Hz
<b>Video Bit Depth</b>			
Set video bit depth	<b>Esc</b> V <b>X9</b> BITD↵	BitdV <b>X9</b> ↵	Set output video bit depth ( <b>X9</b> )
Query video bit depth	<b>Esc</b> VBITD↵	BitdV <b>X9</b> ↵	View output video bit depth ( <b>X9</b> )
<b>DDC Speed</b>			
Set DDC speed (single output)	<b>Esc</b> <b>X1</b> * <b>X8</b> DDCS↵	Ddcs <b>X1</b> * <b>X8</b> ↵	Set DDC speed ( <b>X8</b> ) for output ( <b>X1</b> )
Set DDC speed (all outputs)	<b>Esc</b> ∅* <b>X8</b> DDCS↵	Ddcs∅* <b>X8</b> ↵	Set DDC speed ( <b>X8</b> ) for all outputs (∅)
Query single DDC speed	<b>Esc</b> <b>X1</b> DDCS↵	Ddcs <b>X8</b> ↵	DDC speed ( <b>X8</b> ): 1 = low (20 kbits; default) 2 = high (100 kbits)
<b>Unit Name</b>			
Set unit name	<b>Esc</b> <b>X7</b> CN↵	Ipn• <b>X7</b> ↵	<b>X7</b> The unit name (see explanation on page 14)
View unit name	<b>Esc</b> CN↵	<b>X7</b> ↵	

Command	ASCII Command (host to unit)	Response (unit to host)	Additional Description
<b>Other</b>			
Request part number	N	60-1221-01↵	
Query firmware version	Q	X6↵	Firmware version (with 2 decimals)
Reset	EscZXXX↵	Zpx↵	
Upload firmware	EscUpload↵	...go	During upload process
		Up1↵	When upload is complete

# Updating Firmware

Updates to the DP DA2 firmware are released periodically on the Extron website. You can find the version that is currently loaded on your DA using SIS commands. Compare your firmware version with the latest release on the Extron website and decide whether to update your firmware.

**TIP:** Read the release notes provided on the website with the latest firmware to determine whether you need the latest version.

This chapter describes how to update firmware for the DP DA2:

- [Downloading and Installing Firmware Loader](#)
- [Downloading DP DA2 Firmware](#)
- [Loading the Firmware to the DP DA2](#)
- [Resetting Firmware to the Factory Default Version](#)

## Downloading and Installing Firmware Loader

Extron recommends using the Firmware Loader software to update the firmware on Extron products. If you do not already have Firmware Loader installed on your computer, download it as follows:

1. Go to the Extron website at [www.extron.com](http://www.extron.com) and click the **Download** tab.
2. On the Download Center screen, click the **Software** link on the left sidebar menu.
3. On the next Download Center screen, locate Firmware Loader and click its **Download** link.

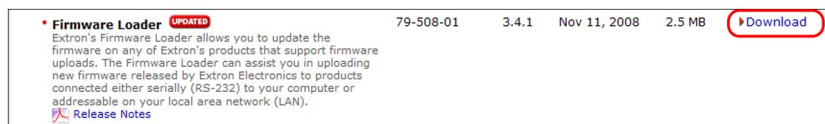

**Figure 8. Firmware Loader Download Link**

4. On the next screen, enter the requested information, then click **Download fw\_loader\_vnxxn.exe** (where *n* is the Firmware Loader version number).
5. Follow the instructions on the rest of the download screens to save the executable Firmware Loader installer file to your computer. Note the folder in which the file was saved.
6. Use a file browser to locate the downloaded executable installer file and double-click it to open it.
7. Follow the instructions on the Installation Wizard screens to install Firmware Loader on your computer. Unless you specify otherwise, the installer program places the Firmware Loader file, FWLoader.exe, at C:\Program Files\Extron\FWLoader.



## Downloading DP DA2 Firmware

To obtain the latest version of firmware for your DP DA2:

1. Visit the Extron website ([www.extron.com](http://www.extron.com)), click the **Download** tab at the top of the page, then click the **Firmware** link on the left sidebar menu.

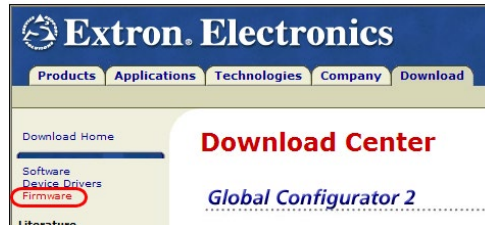

**Figure 9. Firmware Link on the Download Tab**

2. On the next Download Center screen, locate the section for the DP DA2 firmware
3. (Optional) click **Release Notes**. These notes show the issues that have been addressed by the latest update. If these issues do not affect you, you may decide not to upgrade the firmware.
4. Click the DP DA2 **Download** link.
5. On the next screen, enter the requested user information, then click **Download**.
6. Follow the instructions on the rest of the download screens to save the executable firmware file to your computer. Note the folder in which the file was saved.
7. Use a file browser to locate the downloaded executable file. Double-click it to open it.
8. Follow the instructions on the Installation Wizard screens to install the new firmware on your computer. A release notes file, providing information on what has changed in the new firmware version, and a set of instructions for updating the firmware are also loaded.

## Loading the Firmware to the DP DA2

To load a new version of firmware to the switcher using Firmware Loader, connect your computer serial port to the first three pins of the DP DA2 Remote port (see [RS-232 Control](#) on page 9 for information on connecting to the serial port).

1. If you have not already done so, download and install the Firmware Loader executable installer file to your computer (see [Downloading and Installing Firmware Loader](#) on page 18).
2. If necessary, download the latest version of DP DA2 firmware and install it on your computer (see [Downloading DP DA2 Firmware](#) on page 19).
3. Open Firmware Loader via your desktop Start menu by making the following selections:

Start > All Programs > Extron Electronics > Firmware Loader > Firmware Loader

The Firmware Loader dialog opens with the Add Device window displayed in front of it.

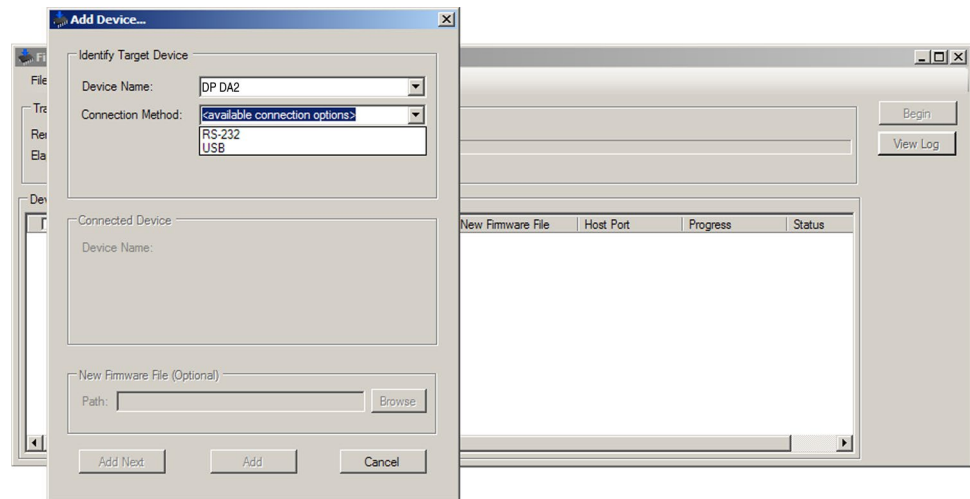

**Figure 10. Opening Firmware Loader**

4. On the Add Device window, select **DP DA2** from the **Device Names** drop-down list.
5. From the **Connection Method** drop-down list, select either **RS-232** or **USB**.
6. Depending on the connection method that you selected, additional options appear. Make the appropriate selections for your connection method.
  - **RS-232:** Select the appropriate options from the **Com Port** and **Baud Rate** menus.
  - **USB:** Only the **Extron USB Device\_0** option is available on the Available Devices menu. Make sure that it is selected.
7. Click **Connect**. If the connection is successful, DP DA2 is displayed in green in the Connected Device section, followed by a green check mark.
8. Click **Browse** in the New Firmware File (Optional) section.

9. In the Open window, navigate to the new firmware file, which has an S19 extension, and double-click it.

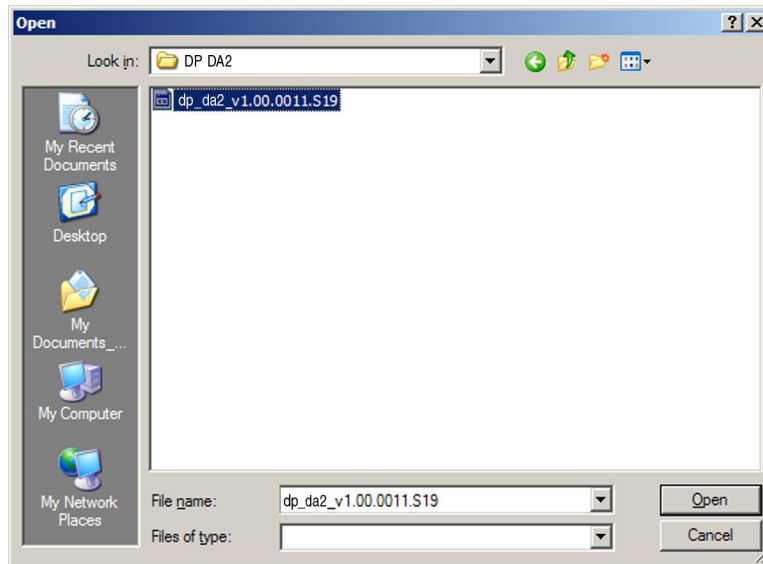

**Figure 11. Open Window for Firmware File Selection**

**ATTENTION:**

- Valid firmware files must have the file extension S19. A file with any other extension is not a firmware upgrade for this product and could cause the switcher to stop functioning.
- Les fichiers firmware valides doivent contenir l'extension fichier S19. Un fichier avec n'importe quelle autre extension n'est pas une mise à jour de firmware pour cet appareil et l'appareil pourrait arrêter de fonctionner.

**NOTES:**

- The original factory-installed firmware is permanently available on the DP DA2. If the attempted firmware upload fails for any reason, the DP DA2 reverts to the factory version.
- When downloaded from the Extron website, by default the firmware is placed in a folder at  
C:\Program Files\Extron\Firmware\DP DA2 (Windows XP) or  
C:\Program Files (x86)\Extron\Firmware\DP DA2 (Windows 7).

10. In the Add Device dialog, the path to the new firmware file is displayed in the **Path** field.

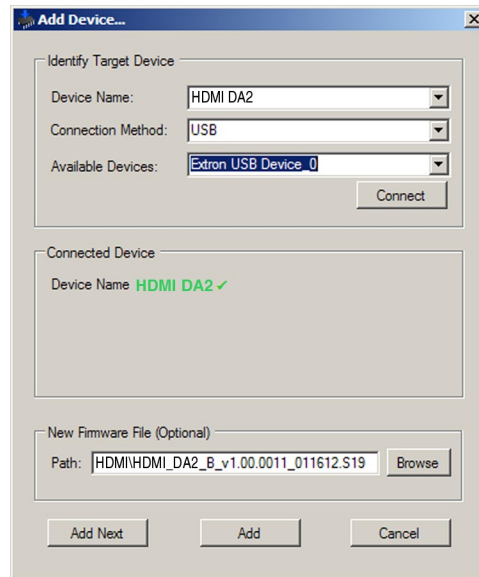
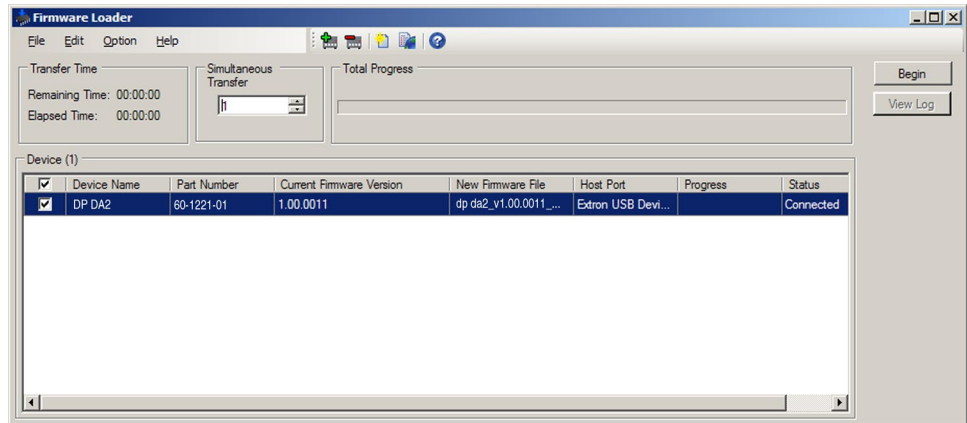

**Figure 12. Path to the New Firmware File on the Add Device Window**

11. **If this is the only device to which you are uploading firmware**, click **Add**. The DP DA2 information is added to the Devices section of Firmware Loader and the Add Device dialog closes.

**If you will be uploading the firmware to multiple DP DA2 units** that are connected to your computer, do the following:

- a. Click **Add Next**. Your first device is added to the Devices section of Firmware Loader, and the Add Device dialog remains open.
- b. For each additional device you want to add to Firmware Loader, repeat steps **5** through **9**, then click **Add Next**.
- c. For the **last** device, click **Add** (instead of **Add Next**) to add the device and to close the Add Device window.



**Figure 13. Firmware Loader Screen with a DP DA2 Added**

**12.** If you want to remove a device from the Devices section, do the following:

- a.** Click the names of the devices to be deleted, to highlight them.
- b.** Select **Remove Selected Device(s)** from the **Edit** menu.
- c.** In the Remove Device(s) window, select or deselect any devices on the list as desired, then click **Remove**.

To remove **all** devices, select **Remove All Devices** from the **Edit** menu.

**13.** Click **Begin**. The following indicators show the progress of the update:

- The Transfer Time section shows the amounts of remaining and elapsed time for the update.
- The Total Progress section displays a progress bar with **Uploading...** above it.
- In the Devices section, the **Progress** column displays an incrementing percentage and another progress bar. The **Status** column displays **Uploading**.

**14.** The upload is complete when the **Remaining Time** field shows **00.00.00**, the **Progress** column shows **100%**, and **Completed** is displayed above the progress bar and in the **Status** column. Close the Firmware Loader window.

## Resetting Firmware to the Factory Default Version

Occasionally the newly installed firmware may conflict with the system. If that occurs, it will be necessary to restore the original (factory-installed) firmware using the reset button, which is located in a recess on the base (see figure 14).

Use a small screwdriver to press the reset button for 10 seconds while powering on the DP DA2. The front panel power LED blinks amber three times, then lights solid amber, and finally blinks amber three more times while the reset occurs. When the reset is complete, the power LED lights solid green.



**Figure 14. Firmware Reset Button on the Base of the DP DA2**

# Mounting

## Desktop Placement

Attach the four provided rubber feet to the bottom of the unit and place it in any convenient location.

## Rack Mounting

### UL Guidelines for Rack Mounting

The following Underwriters Laboratories (UL) guidelines are relevant to the safe installation of these products in a rack:

- 1. Elevated operating ambient temperature** — If the unit is installed in a closed or multi-unit rack assembly, the operating ambient temperature of the rack environment may be greater than room ambient temperature. Therefore, install the equipment in an environment compatible with the maximum ambient temperature (T<sub>ma</sub>: +122 °F, +50 °C) specified by Extron.
- 2. Reduced air flow** — Install the equipment in the rack so that the equipment gets adequate air flow for safe operation.
- 3. Mechanical loading** — Mount the equipment in the rack so that uneven mechanical loading does not create a hazardous condition.
- 4. Circuit overloading** — Connect the equipment to the supply circuit and consider the effect that circuit overloading might have on overcurrent protection and supply wiring. Consider the equipment nameplate ratings when addressing this concern.
- 5. Reliable earthing (grounding)** — Maintain reliable grounding of rack-mounted equipment. Pay particular attention to supply connections other than direct connections to the branch circuit (such as the use of power strips).

### Rack Mounting Procedure

The unit can be mounted on any optional rack mounting system (see [www.extron.com](http://www.extron.com) for a list of suitable mounting kits). To mount the scaler on a rack shelf, follow the instructions provided with the shelf accessories.

# Extron Warranty

Extron Electronics warrants this product against defects in materials and workmanship for a period of three years from the date of purchase. In the event of malfunction during the warranty period attributable directly to faulty workmanship and/or materials, Extron Electronics will, at its option, repair or replace said products or components, to whatever extent it shall deem necessary to restore said product to proper operating condition, provided that it is returned within the warranty period, with proof of purchase and description of malfunction to:

**USA, Canada, South America, and Central America:**

Extron Electronics  
1230 South Lewis Street  
Anaheim, CA 92805  
U.S.A.

**Japan:**

Extron Electronics, Japan  
Kyodo Building, 16 Ichibancho  
Chiyoda-ku, Tokyo 102-0082  
Japan

**Europe and Africa:**

Extron Europe  
Hanzeboulevard 10  
3825 PH Amersfoort  
The Netherlands

**China:**

Extron China  
686 Ronghua Road  
Songjiang District  
Shanghai 201611  
China

**Asia:**

Extron Electronics Asia Pte. Ltd.  
135 Joo Seng Road, #04-01  
PM Industrial Bldg.  
Singapore 368363  
Singapore

**Middle East:**

Extron Middle East  
Dubai Airport Free Zone  
F12, PO Box 293666  
Dubai, United Arab Emirates

This Limited Warranty does not apply if the fault has been caused by misuse, improper handling care, electrical or mechanical abuse, abnormal operating conditions, or if modifications were made to the product that were not authorized by Extron.

**NOTE:** If a product is defective, please call Extron and ask for an Application Engineer to receive an RA (Return Authorization) number. This will begin the repair process.

**USA:** 714.491.1500 or 800.633.9876  
**Asia:** 65.6383.4400

**Europe:** 31.33.453.4040  
**Japan:** 81.3.3511.7655

Units must be returned insured, with shipping charges prepaid. If not insured, you assume the risk of loss or damage during shipment. Returned units must include the serial number and a description of the problem, as well as the name of the person to contact in case there are any questions.

Extron Electronics makes no further warranties either expressed or implied with respect to the product and its quality, performance, merchantability, or fitness for any particular use. In no event will Extron Electronics be liable for direct, indirect, or consequential damages resulting from any defect in this product even if Extron Electronics has been advised of such damage.

Please note that laws vary from state to state and country to country, and that some provisions of this warranty may not apply to you.

<b>Extron Headquarters</b> +1.800.633.9876 (Inside USA/Canada Only) Extron USA - West +1.714.491.1500 +1.714.491.1517 FAX	<b>Extron Europe</b> +800.3987.6673 (Inside Europe Only) Extron USA - East +1.919.850.1000 +1.919.850.1001 FAX	<b>Extron Asia</b> +65.6383.4400 +65.6383.4664 FAX	<b>Extron Japan</b> +81.3.3511.7655 +81.3.3511.7656 FAX	<b>Extron China</b> +86.21.3760.1568 +86.21.3760.1566 FAX	<b>Extron Middle East</b> +971.4.299.1800 +971.4.299.1880 FAX	<b>Extron Korea</b> +82.2.3444.1571 +82.2.3444.1575 FAX	<b>Extron India</b> 1800.3070.3777 (Inside India Only) +91.80.3055.3777 +91.80.3055.3737 FAX
---	---	--	---	---	---	---	--

## Free Manuals Download Website

<http://myh66.com>

<http://usermanuals.us>

<http://www.somanuals.com>

<http://www.4manuals.cc>

<http://www.manual-lib.com>

<http://www.404manual.com>

<http://www.luxmanual.com>

<http://aubethermostatmanual.com>

Golf course search by state

<http://golfingnear.com>

Email search by domain

<http://emailbydomain.com>

Auto manuals search

<http://auto.somanuals.com>

TV manuals search

<http://tv.somanuals.com>