

XTRA™ Full Rack Series:

XPA 2002

XPA 2002-70V

XPA 2002-100V

XPA 2003C-70V

XPA 2003C-100V

XPA 2004

Full-Rack 2-, 3-, and 4-Channel Mono and Stereo Audio Power Amplifiers



Extron® Electronics
INTERFACING, SWITCHING AND CONTROL

Safety Instructions • English



This symbol is intended to alert the user of important operating and maintenance (servicing) instructions in the literature provided with the equipment.



This symbol is intended to alert the user of the presence of uninsulated dangerous voltage within the product's enclosure that may present a risk of electric shock.

Caution

Read Instructions • Read and understand all safety and operating instructions before using the equipment.

Retain Instructions • The safety instructions should be kept for future reference.

Follow Warnings • Follow all warnings and instructions marked on the equipment or in the user information.

Avoid Attachments • Do not use tools or attachments that are not recommended by the equipment manufacturer because they may be hazardous.

Consignes de Sécurité • Français



Ce symbole sert à avertir l'utilisateur que la documentation fournie avec le matériel contient des instructions importantes concernant l'exploitation et la maintenance (réparation).



Ce symbole sert à avertir l'utilisateur de la présence dans le boîtier de l'appareil de tensions dangereuses non isolées posant des risques d'électrocution.

Attention

Lire les instructions • Prendre connaissance de toutes les consignes de sécurité et d'exploitation avant d'utiliser le matériel.

Conserver les instructions • Ranger les consignes de sécurité afin de pouvoir les consulter à l'avenir.

Respecter les avertissements • Observer tous les avertissements et consignes marqués sur le matériel ou présentés dans la documentation utilisateur.

Eviter les pièces de fixation • Ne pas utiliser de pièces de fixation ni d'outils non recommandés par le fabricant du matériel car cela risquerait de poser certains dangers.

Sicherheitsanleitungen • Deutsch



Dieses Symbol soll dem Benutzer in der im Lieferumfang enthaltenen Dokumentation besonders wichtige Hinweise zur Bedienung und Wartung (Instandhaltung) geben.



Dieses Symbol soll den Benutzer darauf aufmerksam machen, daß im Inneren des Gehäuses dieses Produktes gefährliche Spannungen, die nicht isoliert sind und die einen elektrischen Schock verursachen können, herrschen.

Achtung

Lesen der Anleitungen • Bevor Sie das Gerät zum ersten Mal verwenden, sollten Sie alle Sicherheits- und Bedienungsanleitungen genau durchlesen und verstehen.

Aufbewahren der Anleitungen • Die Hinweise zur elektrischen Sicherheit des Produktes sollten Sie aufbewahren, damit Sie im Bedarfsfall darauf zurückgreifen können.

Befolgen der Warnhinweise • Befolgen Sie alle Warnhinweise und Anleitungen auf dem Gerät oder in der Benutzerdokumentation.

Keine Zusatzgeräte • Verwenden Sie keine Werkzeuge oder Zusatzgeräte, die nicht ausdrücklich vom Hersteller empfohlen wurden, da diese eine Gefahrenquelle darstellen können.

Instrucciones de seguridad • Español



Este símbolo se utiliza para advertir al usuario sobre instrucciones importantes de operación y mantenimiento (o cambio de partes) que se desean destacar en el contenido de la documentación suministrada con los equipos.



Este símbolo se utiliza para advertir al usuario sobre la presencia de elementos con voltaje peligroso sin protección aislante, que puedan encontrarse dentro de la caja o alojamiento del producto, y que puedan representar riesgo de electrocución.

Precaución

Leer las instrucciones • Leer y analizar todas las instrucciones de operación y seguridad, antes de usar el equipo.

Conservar las instrucciones • Conservar las instrucciones de seguridad para futura consulta.

Obedecer las advertencias • Todas las advertencias e instrucciones marcadas en el equipo o en la documentación del usuario, deben ser obedecidas.

Evitar el uso de accesorios • No usar herramientas o accesorios que no sean específicamente recomendados por el fabricante, ya que podrían implicar riesgos.

安全须知 • 中文



这个符号提示用户该设备用户手册中有重要的操作和维护说明。



这个符号警告用户该设备机壳内有暴露的危险电压，有触电危险。

注意

阅读说明书 • 用户使用该设备前必须阅读并理解所有安全和使用说明。

保存说明书 • 用户应保存安全说明书以备将来使用。

遵守警告 • 用户应遵守产品和用户指南上的所有安全和操作说明。

避免追加 • 不要使用该产品的厂商没有推荐的工具或追加设备，以避免危险。

Warning

Power sources • This equipment should be operated only from the power source indicated on the product. This equipment is intended to be used with a main power system with a grounded (neutral) conductor. The third (grounding) pin is a safety feature, do not attempt to bypass or disable it.

Power disconnection • To remove power from the equipment safely, remove all power cords from the rear of the equipment, or the desktop power module (if detachable), or from the power source receptacle (wall plug).

Power cord protection • Power cords should be routed so that they are not likely to be stepped on or pinched by items placed upon or against them.

Servicing • Refer all servicing to qualified service personnel. There are no user-serviceable parts inside. To prevent the risk of shock, do not attempt to service this equipment yourself because opening or removing covers may expose you to dangerous voltage or other hazards.

Slots and openings • If the equipment has slots or holes in the enclosure, these are provided to prevent overheating of sensitive components inside. These openings must never be blocked by other objects.

Lithium battery • There is a danger of explosion if battery is incorrectly replaced. Replace it only with the same or equivalent type recommended by the manufacturer. Dispose of used batteries according to the manufacturer's instructions.

Avertissement

Alimentations • Ne faire fonctionner ce matériel qu'avec la source d'alimentation indiquée sur l'appareil. Ce matériel doit être utilisé avec une alimentation principale comportant un fil de terre (neutre). Le troisième contact (de mise à la terre) constitue un dispositif de sécurité : n'essayez pas de la contourner ni de la désactiver.

Déconnexion de l'alimentation • Pour mettre le matériel hors tension sans danger, déconnectez tous les cordons d'alimentation de l'arrière de l'appareil ou du module d'alimentation de bureau (s'il est amovible) ou encore de la prise secteur.

Protection du cordon d'alimentation • Acheminer les cordons d'alimentation de manière à ce que personne ne risque de marcher dessus et à ce qu'ils ne soient pas écrasés ou pincés par des objets.

Réparation-maintenance • Faire exécuter toutes les interventions de réparation-maintenance par un technicien qualifié. Aucun des éléments internes ne peut être réparé par l'utilisateur. Afin d'éviter tout danger d'électrocution, l'utilisateur ne doit pas essayer de procéder lui-même à ces opérations car l'ouverture ou le retrait des couvercles risquent de l'exposer à de hautes tensions et autres dangers.

Fentes et orifices • Si le boîtier de l'appareil comporte des fentes ou des orifices, ceux-ci servent à empêcher les composants internes sensibles de surchauffer. Ces ouvertures ne doivent jamais être bloquées par des objets.

Lithium Batterie • Il y a danger d'explosion s'il y a un remplacement incorrect de la batterie. Remplacer uniquement avec une batterie du même type ou d'un type équivalent recommandée par le constructeur. Mettre au rebut les batteries usagées conformément aux instructions du fabricant.

Vorsicht

Stromquellen • Dieses Gerät sollte nur über die auf dem Produkt angegebene Stromquelle betrieben werden. Dieses Gerät wurde für eine Verwendung mit einer Hauptstromleitung mit einem geerdeten (neutralen) Leiter konzipiert. Der dritte Kontakt ist für einen Erdschluss, und stellt eine Sicherheitsfunktion dar. Diese sollte nicht umgangen oder außer Betrieb gesetzt werden.

Stromunterbrechung • Um das Gerät auf sichere Weise vom Netz zu trennen, sollten Sie alle Netzkabel aus der Rückseite des Gerätes, aus der externen Stromversorgung (falls dies möglich ist) oder aus der Wandsteckdose ziehen.

Schutz des Netzkabels • Netzkabel sollten stets so verlegt werden, daß sie nicht im Weg liegen und niemand darauf treten kann oder Objekte darauf- oder unmittelbar dagegengestellt werden können.

Wartung • Alle Wartungsmaßnahmen sollten nur von qualifiziertem Servicepersonal durchgeführt werden. Die internen Komponenten des Gerätes sind wartungsfrei. Zur Vermeidung eines elektrischen Schocks versuchen Sie in keinem Fall, dieses Gerät selbst öffnen, da beim Entfernen der Abdeckungen die Gefahr eines elektrischen Schlags und/oder andere Gefahren bestehen.

Schlitze und Öffnungen • Wenn das Gerät Schlitze oder Löcher im Gehäuse aufweist, dienen diese zur Vermeidung einer Überhitzung der empfindlichen Teile im Inneren. Diese Öffnungen dürfen niemals von anderen Objekten blockiert werden.

Lithium-Batterie • Explosionsgefahr, falls die Batterie nicht richtig ersetzt wird. Ersetzen Sie verbrauchte Batterien nur durch den gleichen oder einen vergleichbaren Batterietyp, der auch vom Hersteller empfohlen wird. Entsorgen Sie verbrauchte Batterien bitte gemäß den Herstelleranweisungen.

Advertencia

Alimentación eléctrica • Este equipo debe conectarse únicamente a la fuente/tipo de alimentación eléctrica indicada en el mismo. La alimentación eléctrica de este equipo debe provenir de un sistema de distribución general con conductor neutro a tierra. La tercera pata (puesta a tierra) es una medida de seguridad, no puentearla ni eliminarla.

Desconexión de alimentación eléctrica • Para desconectar con seguridad la acometida de alimentación eléctrica al equipo, desenchufar todos los cables de alimentación en el panel trasero del equipo, o desenchufar el módulo de alimentación (si fuera independiente), o desenchufar el cable del receptáculo de la pared.

Protección de los cables de alimentación • Los cables de alimentación eléctrica se deben instalar en lugares donde no sean pisados ni apretados por objetos que se puedan apoyar sobre ellos.

Reparaciones/mantenimiento • Solicitar siempre los servicios técnicos de personal calificado. En el interior no hay partes a las que el usuario deba acceder. Para evitar riesgo de electrocución, no intentar personalmente la reparación/mantenimiento de este equipo, ya que al abrir o extraer las tapas puede quedar expuesto a voltajes peligrosos u otros riesgos.

Ranuras y aberturas • Si el equipo posee ranuras o orificios en su caja/alojamiento, es para evitar el sobrecalentamiento de componentes internos sensibles. Estas aberturas nunca se deben obstruir con otros objetos.

Batería de litio • Existe riesgo de explosión si esta batería se coloca en la posición incorrecta. Cambiar esta batería únicamente con el mismo tipo (o su equivalente) recomendado por el fabricante. Desachar las baterías usadas siguiendo las instrucciones del fabricante.

警告

电源 • 该设备只能使用产品上标明的电源。设备必须使用有地线的供电系统供电。第三条线（地线）是安全设施，不能不用或跳过。

拔掉电源 • 为安全地从设备拔掉电源，请拔掉所有设备后或桌面电源的电源线，或任何接到市电系统的电源线。

电源线保护 • 妥善布线，避免被踩踏，或重物挤压。

维护 • 所有维修必须由认证的维修人员进行。设备内部没有用户可以更换的零件。为避免出现触电危险不要自己试图打开设备盖子维修该设备。

通风孔 • 有些设备机壳上有通风槽或孔，它们是用来防止机内敏感元件过热。不要使用任何东西挡住通风孔。

锂电池 • 不正确的更换电池会有爆炸的危险。必须使用与厂家推荐的相同或相近型号的电池。按照生产厂家的建议处理废弃电池。

FCC Class B Notice

This equipment has been tested and found to comply with the limits for a Class B digital device, pursuant to part 15 of the FCC Rules. These limits are designed to provide reasonable protection against harmful interference in a residential installation. This equipment generates, uses and can radiate radio frequency energy and, if not installed and used in accordance with the instructions, may cause harmful interference to radio communications. However, there is no guarantee that the interference will not occur in a particular installation. If this equipment does cause harmful interference to radio or television reception, which can be determined by turning the equipment off and on, the user is encouraged to try to correct the interference by one or more of the following measures:

- Reorient or relocate the receiving antenna.
- Increase the separation between the equipment and receiver.
- Connect the equipment into an outlet on a circuit different from that to which the receiver is connected.
- Consult the dealer or an experienced radio/TV technician for help.

NOTE: This unit was tested with shielded cables on the peripheral devices. Shielded cables must be used with the unit to ensure compliance with FCC emissions limits

For complete safety information about these products please read the Safety Compliances sheet, which is available online at www.extron.com..

Conventions Used in this Guide

In this user guide, the following are used:

NOTE: A note draws attention to important information.

TIP: A tip provides a suggestion to make working with the application easier.

CAUTION: A caution indicates a potential hazard to equipment or data.

WARNING: A warning warns of things or actions that might cause injury, death, or other severe consequences.

Copyright

© 2011 Extron Electronics. All rights reserved.

Trademarks

All trademarks mentioned in this guide are the properties of their respective owners.

Contents

- Introduction** 1
 - About this Guide 1
 - Terms Used in this Guide..... 1
 - Features..... 2

- Installation** 3
 - Application Examples..... 3

- Operation**..... 7
 - Front Panel Features and Operation 7
 - Rear Panel Features and Operation..... 9
 - Bridged Mode Output..... 15

- Reference Information** 18
 - Specifications..... 18
 - Part Numbers..... 23
 - Included Parts 23
 - Mounting the XTRA Series of Power Amplifiers. 25
 - Tabletop Use 25
 - UL Rack Mounting Guidelines 25
 - Rack Mounting 25

Introduction

About this Guide

This guide contains information about the Extron® series of audio power amplifiers: the XPA 2002 two-channel stereo amplifier, the XPA 2002-70V two-channel, 70 V line distribution mono amplifier; the XPA 2002-100V two-channel, 100 V line distribution mono amplifier; the XPA 2003C-70V three-channel, stereo 4-ohm and 8-ohm, mono 70 V line distribution amplifier; the XPA 2003C-100V three-channel, stereo 4-ohm, 8-ohm, mono 100 V line distribution amplifier; and the XPA 2004 four-channel stereo amplifier.

The XPA series of amplifiers are full-rack width models with different power outputs:

- XPA 2002 outputs stereo 200 watts rms per channel (4-ohm speakers) or 100 watts rms per channel (8-ohm speakers) on channels 1 and 2. Output is 400 watts bridged mode mono (8-ohm speaker).
- XPA 2002-70V outputs 200 watts rms per channel on channels 1 and 2 for 70 V systems.
- XPA 2002-100V outputs 200 watts rms per channel on channels 1 and 2 for 100 V systems.
- XPA 2003C-70V outputs 200 watts per channel (4-ohm speakers) or 100 watts per channel (8-ohm speakers) on channels 1 and 2, and 200 watts (70 V line, mono) on channel 3.
- XPA 2003C-100V outputs 200 watts per channel (4-ohm speakers) or 100 watts per channel (8-ohm speakers) on channels 1 and 2, and 200 watts (100 V line, mono) on channel 3.
- XPA 2004 outputs stereo 200 watts per channel (4-ohm speakers) or 100 watts per channel (8-ohm speakers) on channels 1, 2, 3, and 4. Output is 400 watts per bridge in bridged mono (8-ohm speakers) on bridge A (channels 1 and 2) and bridge B (channels 3 and 4).

Terms Used in this Guide

The terms “amplifier” and “power amplifier” are used interchangeably in this guide to refer to each model.

Features

Extron Patented Class D Ripple Steering (CDRS™) technology — CDRS is an Extron patented technology that provides a smooth, clean audio waveform and an improvement in signal fidelity over conventional Class D amplifier designs. CDRS eliminates the high frequency switching ripple characteristic of Class D amplifiers, a source of RF emissions, which can interfere with sensitive A/V equipment such as wireless microphones.

Professional grade signal-to-noise and THD performance — Delivers professional grade performance with 100 dB signal-to-noise ratio and THD of less than 0.1%.

Front and rear panel LED indicators —

- Display limiter/protect status when audio clipping or amplifier malfunction occurs.
- Indicate the presence of input signals.

Audio level adjustment — Potentiometers to adjust the audio level from ∞ (full attenuation) to 0 dB (no attenuation).

IEC power switch — Rear panel IEC rocker power switch.

1U full rack enclosure — The capability to deliver full-sized amplifier power in one half the size of many comparable power amplifiers.

High pass filtering — A high pass filter (XPA 2002-70V, XPA 2002-100V, XPA 2003C-70V, and XPA 2003C-100V only) toggle switch prevents saturation of speaker input transformers by low frequency signals. Saturation can result in severe distortion of the speaker output signal.

Bridged output mode — The XPA 2004 has a toggle switch to input channels 1 and 3 and output each input as a single bridged output channel at twice the power of a single channel. Input 1 is output over the positive terminals of output channels 1 and 2. Input 3 is output over the positive terminals of output channels 3 and 4.

The XPA 2002 has a toggle switch to input channel 1 and output a single bridged output channel at twice the power using the positive terminals of channels 1 and 2.

Convection cooled, fanless operation — Ensuring quiet reliable operation. All models generate substantially less heat than similar power amplifier designs.

Automatic clip limiter — Detects actual onset of clipping by comparing input and output waveforms. Gain is automatically reduced with a slow attack and fast release to eliminate clipping. This advanced limiter design protects the speakers from clipping distortion and offers superior sonic characteristics compared to limiters that use signal compression.

Rear panel recessed, detented level controls — Provide attenuation of input signals for adjusting audio system gain staging as well as multi-zone applications. They are located on the rear panel to prevent users from tampering with level adjustments.

Remote standby — Standby control that remotely shuts off all amplifier output while power remains active at the amplifier.

Power factor correction — Features power factor correction technology that smoothes out the high peak currents of the current draw of the amplifier, thus minimizing the presence of high frequency harmonics on the AC power line, and therefore preventing audible artifacts from being transmitted to other audio equipment in the system.

Class 2 wiring — The outputs from the amplifiers support Class 2 wiring that meets UL requirements.

ENERGY STAR® qualified — All models are ENERGY STAR qualified amplifiers that conserve energy and reduce costs.

Installation

This section discusses how to install the XTRA Series of full rack power amplifiers.

WARNING: Installation and service must be performed by authorized personnel only (see “[UL Rack Mounting Guidelines](#)”).

Application Examples

The following illustrations are application examples for the XPA 2002, XPA 2002-70V, XPA 2003C-70V, and XPA 2004. Application examples for the XPA 2002-100V and XPA 2003C-100V are very similar to the XPA 2002-70V and XPA 2003C-70V examples, respectively.

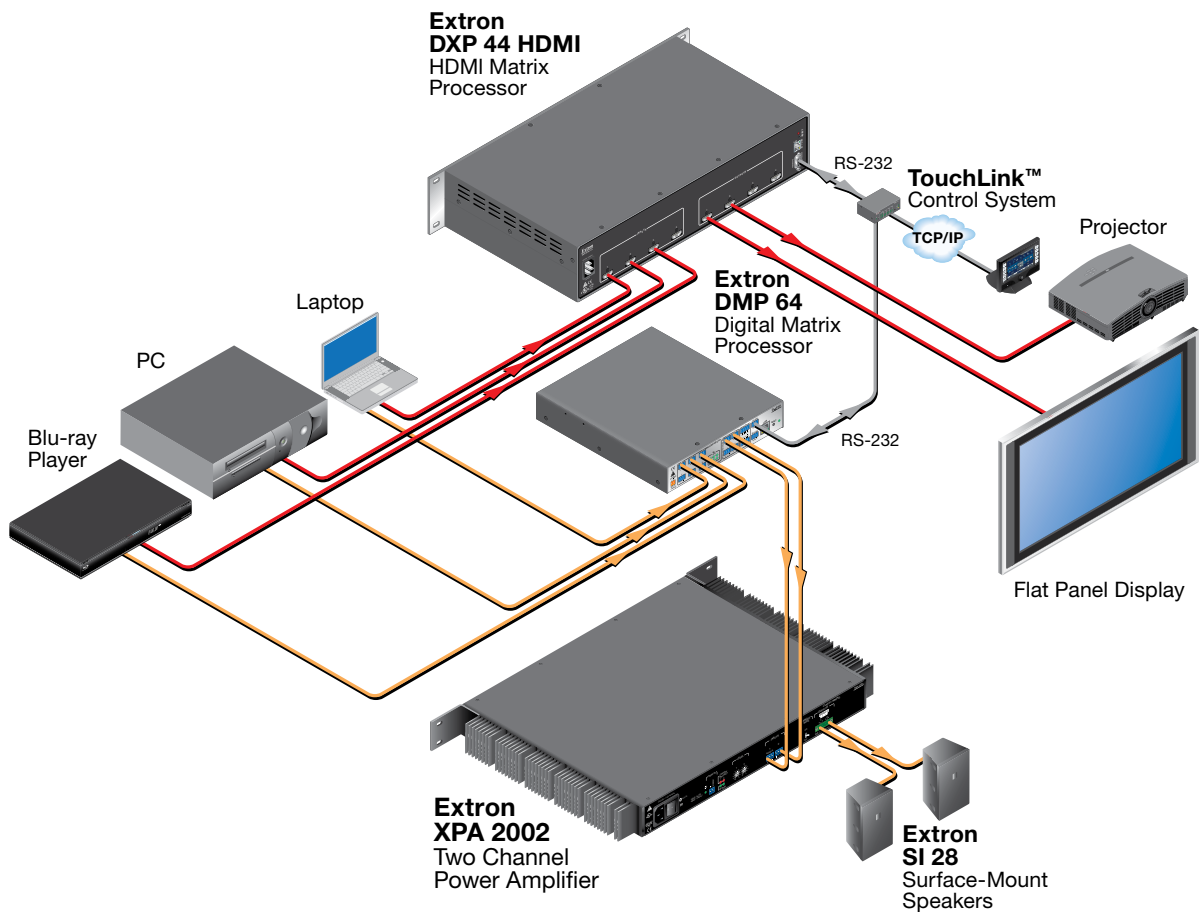

Figure 1. XPA 2002 Application Example

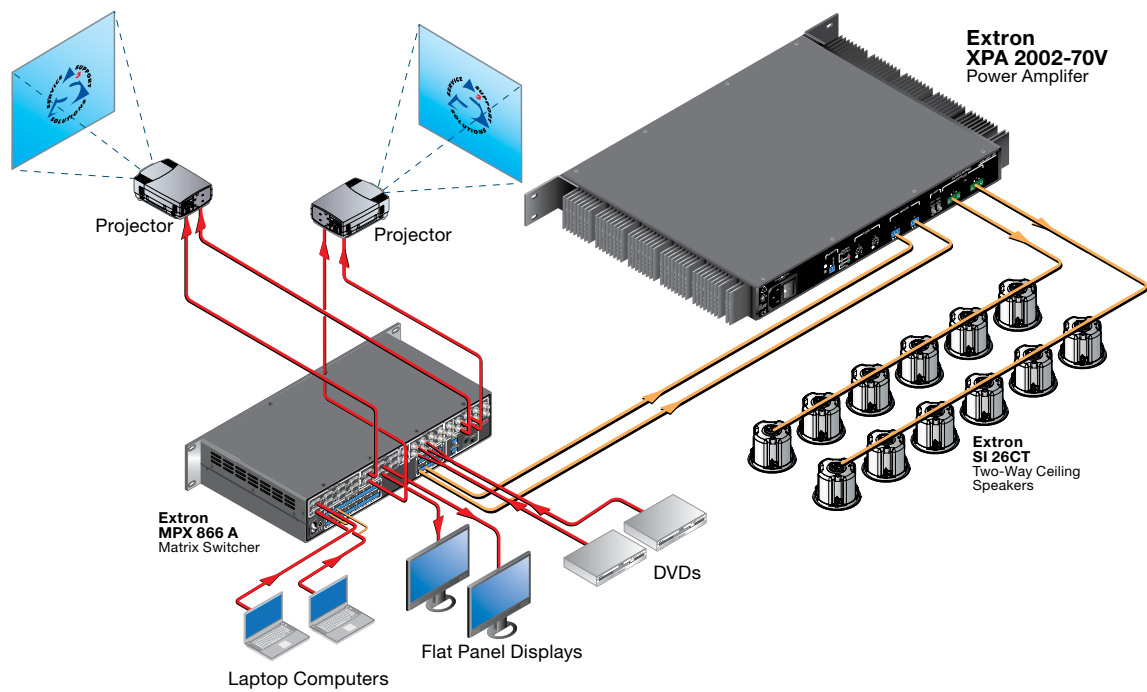

Figure 2. XPA 2002-70V Application Example

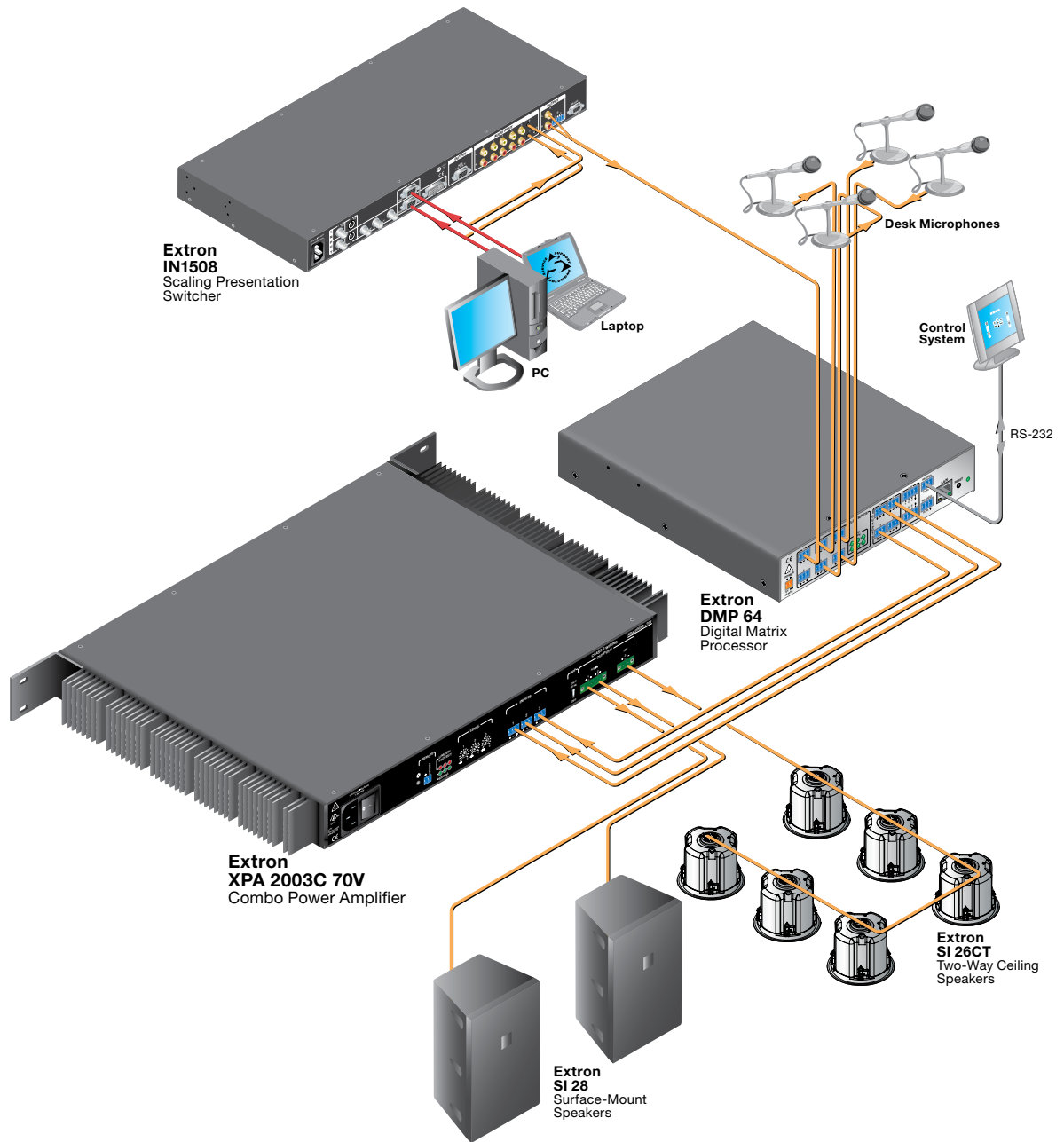

Figure 3. XPA 2003C-70V Application Example

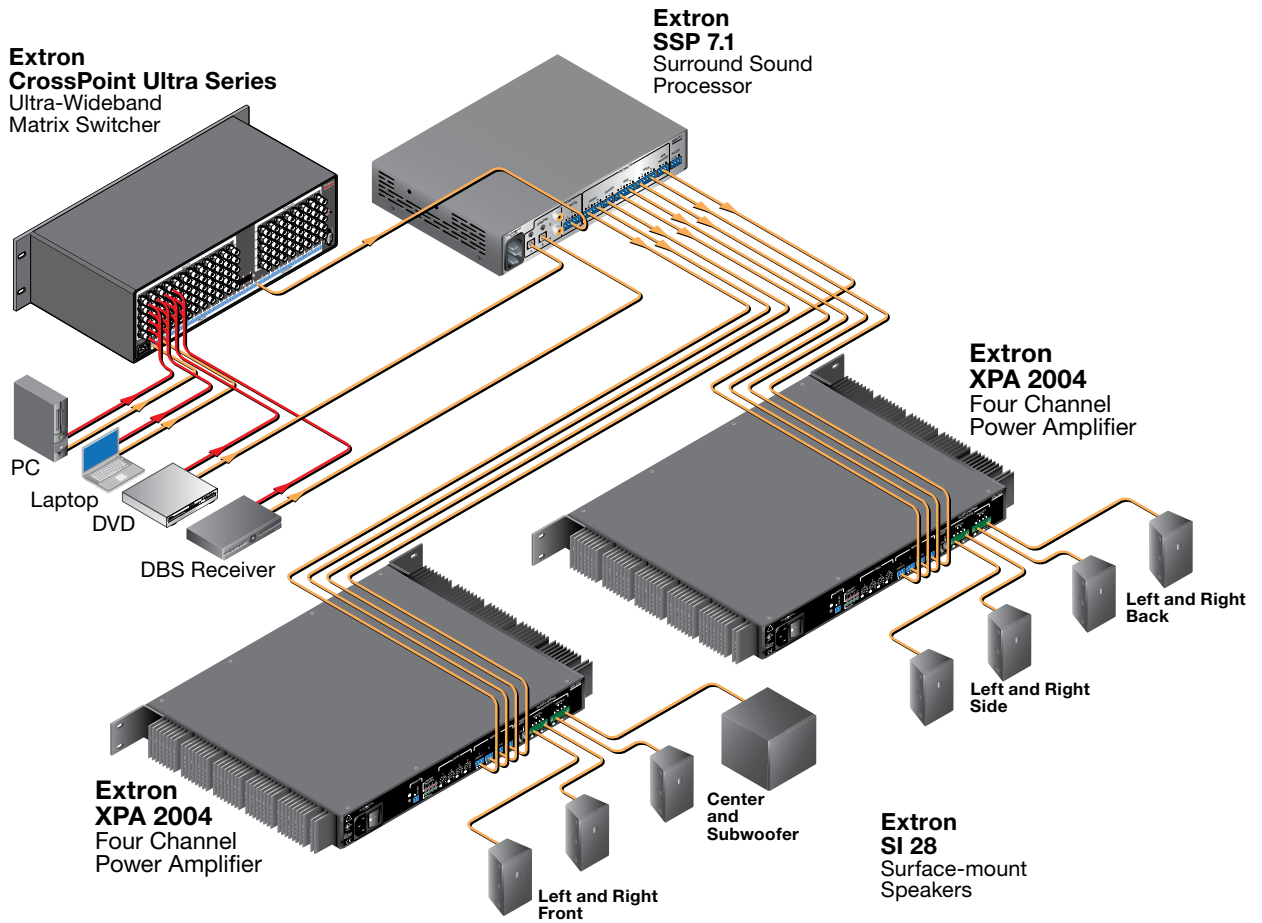

Figure 4. XPA 2004 Application Example

Operation

This section discusses how to operate the XPA power amplifiers. Topics that are covered, include:

- [Front Panel Features and Operation](#)
- [Rear Panel Features and Operation](#)
- [Bridged Mode Output](#)

Front Panel Features and Operation

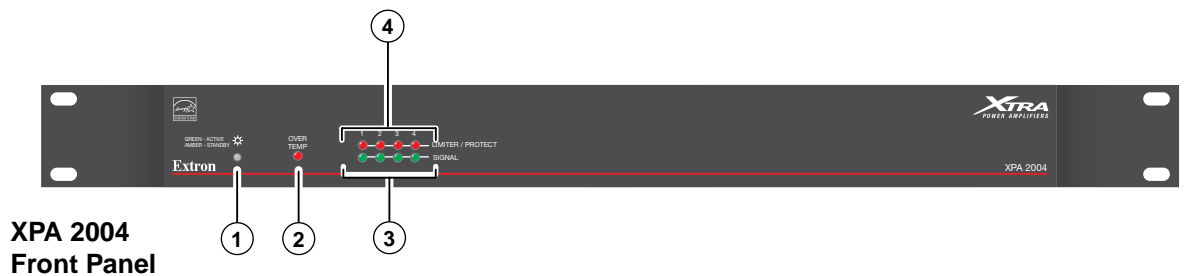
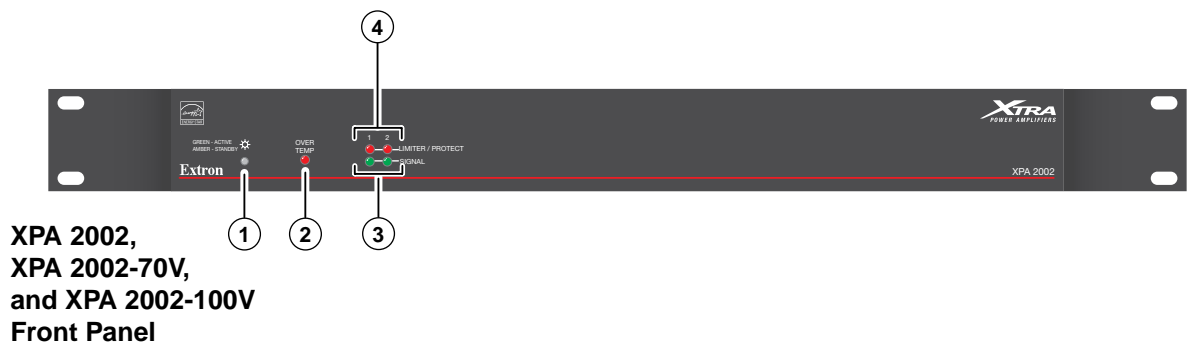

- ① **Power indicator LED** — This LED lights:
 - Green when the amplifier is receiving full power.
 - Amber when the amplifier is in Standby mode. Standby mode turns off all outputs from the amplifier, although the amplifier is still receiving power (see ④ of "[Rear Panel Features and Operation](#)").
- ② **Over Temp indicator LED** — This LED lights red when the amplifier exceeds the recommended operating temperature for optimal lifetime. The LED turns off after the amplifier has cooled down sufficiently.

Should the LED light, check the following:

- Verify that the placement of the amplifier allows for adequate ventilation and airflow.
 - Avoid placing other equipment on top of the amplifier.
 - Verify that the operating temperature is within the specified range.
- ③ **Signal indicator LEDs (channels 1, 2, 3, and 4)** — These LEDs (representing input channels 1, 2, 3, and 4) light green only when an input signal is detected on the corresponding channel.

NOTE: These LEDs are also located on the rear panel.

- ④ **Limiters/Protect indicator LEDs (channels 1, 2, 3, and 4)** — These LEDs (representing output channels 1, 2, 3, and 4) light red under the following circumstances:
 - When audio clipping occurs, the corresponding channel's LED blinks once per clip occurrence.
 - When the amplifier overheats, both LEDs are lit. The LEDs are not lit after the amplifier recovers from the overheated condition.
 - When DC output is detected, the amplifier is malfunctioning and the LED for the corresponding channel is lit. The amplifier requires servicing when this event occurs.
 - When the output leads are shorted, the LED of the corresponding channel is lit until the short is removed.

NOTE: These LEDs are also located on the rear panel.

Rear Panel Features and Operation

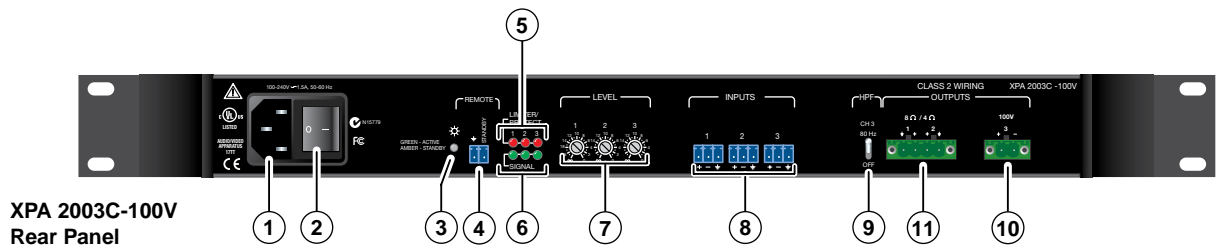
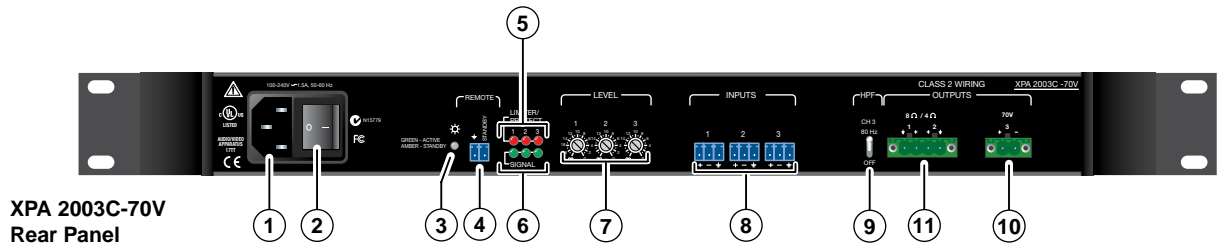
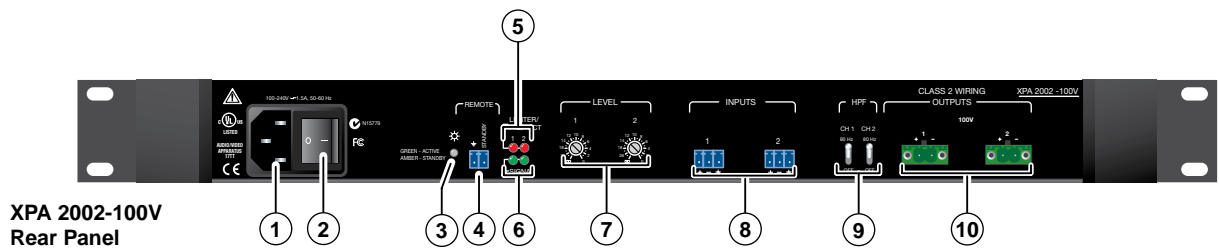
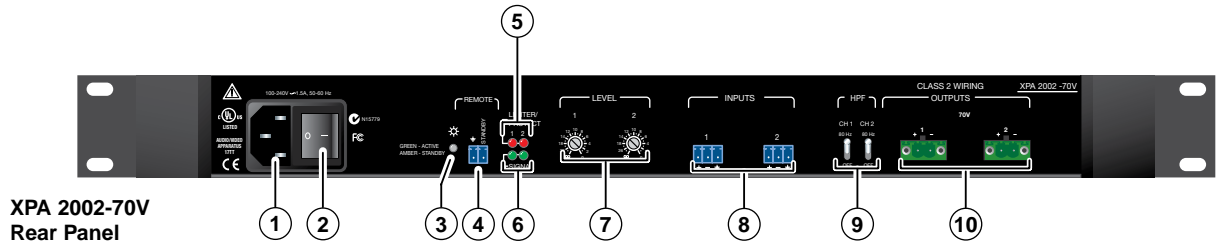
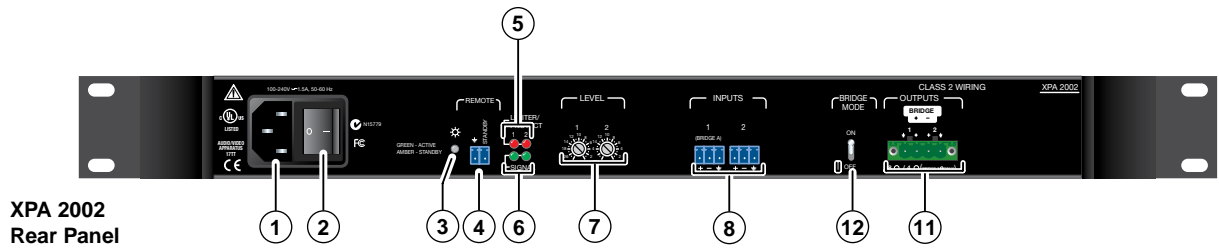

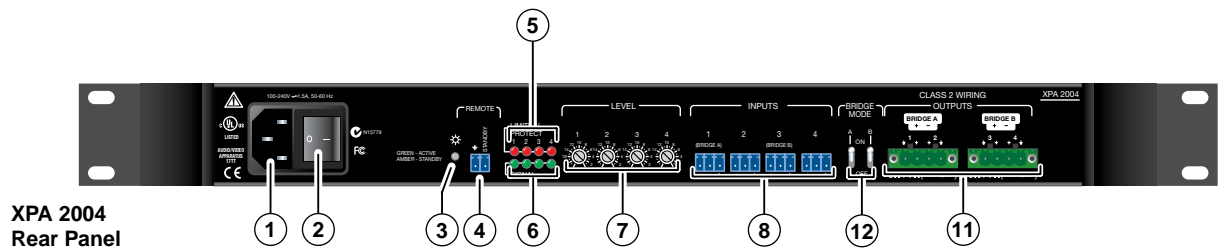

XPA 2004
Rear Panel

- ① **AC power connector** — Connect a standard IEC AC power cord here for power input (100 VAC to 240 VAC, 50/60 Hz) to the internal, autoswitching power supply.
- ② **Power switch** — This rocker switch turns power to the amplifier on or off. The off position also disables remote standby (see ④).
- ③ **Power indicator LED** — This LED lights:
 - Green when the amplifier is receiving full power.
 - Amber when the amplifier is in standby mode. Standby mode turns off all outputs from the amplifier, although the amplifier is still receiving power.
- ④ **Remote standby connector** — Connecting pin 2 to ground (pin 1) places the amplifier in standby mode. Standby mode turns off all outputs, although the amplifier is still receiving power.

NOTE: The amplifier automatically enters standby mode after 25 minutes of inactivity (+/- 5 minutes).

Use the included 2-pin, 3.5 mm captive screw connector to jumper the pins.



- ⑤ **Limiter/Protect indicator LEDs (channels 1, 2, 3, and 4)** — These LEDs (representing output channels 1, 2, 3, and 4) light red under four circumstances:
 - When audio clipping occurs, the LED of the corresponding channel blinks once per clip occurrence.
 - When the amplifier overheats, both LEDs are lit. The LEDs are not lit after the amplifier cools down and recovers from the overheated condition.
 - When DC output is detected, the amplifier is malfunctioning and the LED for the corresponding channel is lit. When a malfunction occurs, power down the amplifier and power it back up. If the LED still remains lit, the amplifier requires servicing.
 - When the output leads are shorted, the LED of the corresponding channel is lit until the short is removed.
- ⑥ **Signal indicator LEDs (channels 1, 2, 3 and 4)** — These LEDs (representing input channels 1, 2, 3 and 4) light green only when an input signal is detected on the corresponding channel.

- ⑦ **Level adjustment (channels 1, 2, 3 and 4)** — Use a Tweezer or small screwdriver to adjust the audio input level for the corresponding channel. The analog potentiometers control the level from ∞ (full attenuation) to 0 dB (no attenuation).

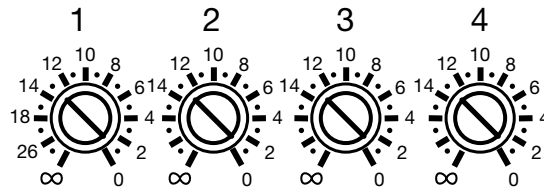

- ⑧ **Balanced or unbalanced stereo/mono audio input connector** — Wire the 3.5 mm 3-pin captive screw connectors for balanced or unbalanced input.

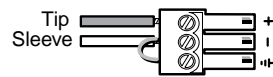

Unbalanced Input

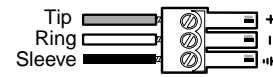

Balanced Input

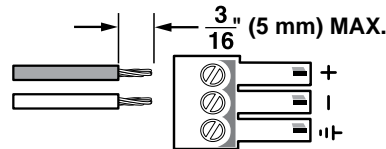

NOTE: The wires **must not** be tinned: tinned wire does not hold tight in the captive screws and can break easily after several bends.

NOTE: The XPA 2004 allows for bridged output of inputs 1 (Bridge A) and 3 (Bridge B) only. Bridging effectively doubles the output power of those inputs. Inputs 1 and 3 are the active inputs when in bridged mode while inputs 2 and 4 are ignored (see the diagram below).

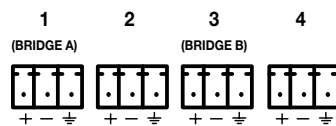

NOTE: The XPA 2002 allows for bridged output of input 1. Bridging effectively doubles the output power of input 1 while input 2 is ignored (see the diagram below).

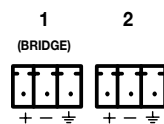

- 9 **High pass filter toggle switch** — Use a small screwdriver to toggle this recessed two-position toggle switch that alternates between Off (no filtering) and 80 Hz. The XPA 2002-70V and XPA 2002-100V have 2 switches, one for each output channel. The XPA 2003C-70V and XPA 2003C-100V have one switch for the line distribution output channel (channel 3). Setting the switch to 80 Hz prevents the saturation of the speaker input transformers by low frequency signals. Saturation may result in undesired overheating of the speaker transformers.

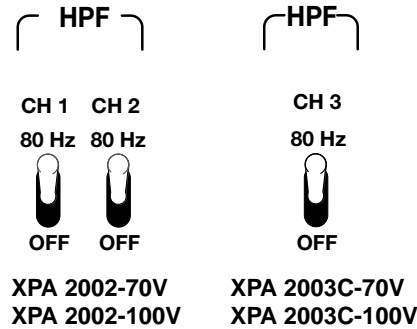

NOTE: It is recommended that the high pass filter be left in the On position unless filtering is applied to the signal upstream of the amplifier.

- 10 **Mono audio output connector** — Marked “+” and “-”, wire the included 2-pole, 5 mm screw lock captive screw connector for mono audio. See steps 1 and 2 on the following page. Output is designed to power 70 V (XPA 2002-70V and XPA 2003C-70V) or 100 V (XPA 2002-100V and XPA 2003C-100V) line distribution systems and is rated at 200 watts.

NOTE: You must use Class 2 wiring for this output to comply with UL requirements.

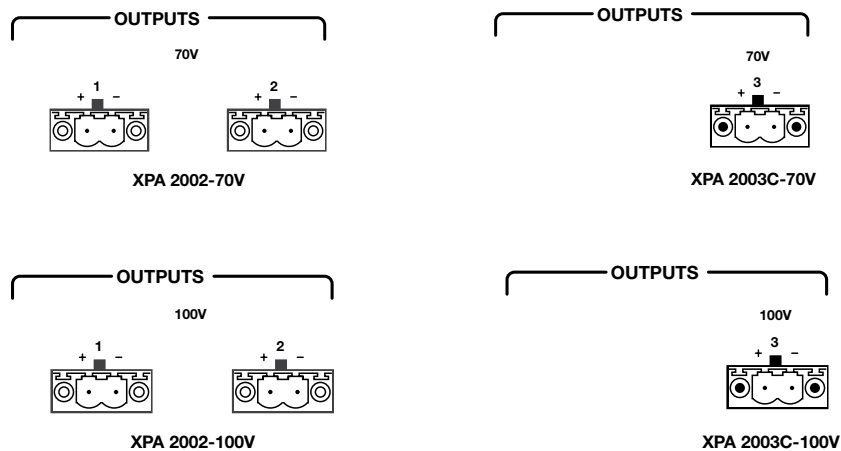

CAUTION: Do not short out the “+” and “-” connectors with each other or to ground; doing so will short the outputs and may damage the amplifier.

Step 1: Strip and insert the speaker wires into the connector and tighten the captive screws. Be sure to observe correct polarity.

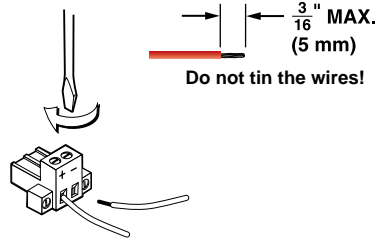

Step 2: Insert the wired connector into the amplifier output and secure the locking screws on either side.

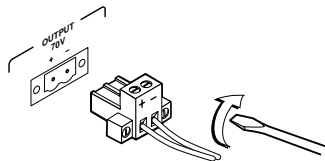

11 **Stereo audio output connector** — Wire the included 4-pole, 5 mm screw lock captive screw connector to output 2-channel (XPA 2002, XPA 2003C-70V, and XPA 2003C-100V) or 4-channel (XPA 2004) audio. Observe the correct polarities for each channel. See the steps **1** and **2** on the following page. Output is designed to power 4 or 8 ohm speakers and is rated at 200 watts (4-ohm speaker load) or 100 watts (8-ohm speaker load) per channel.

NOTE: You must use Class 2 wiring for this output to comply with UL requirements.

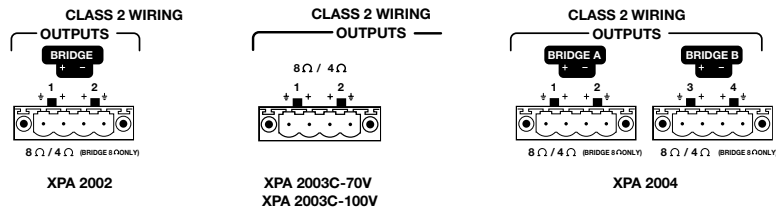

CAUTION: Do not tie the "+" and "≠" outputs to each other. Doing so will short out the outputs and may damage the amplifier.

Step 1: Strip and insert the speaker wires into the connector and tighten the captive screws. Be sure to observe the correct polarity.

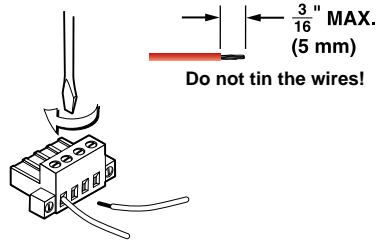

Step 2: Insert the wired connector into the amplifier output and secure the locking screws on either side.

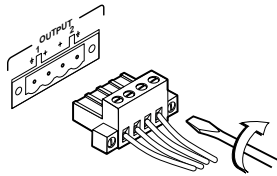

12 Bridged output mode (XPA 2002 and XPA 2004) —

The output power of the XPA 2002 can be effectively doubled by using input channel 1 and bridging the outputs.

The output power of the XPA 2004 can be effectively doubled by using input channels 1 or 3 or both and bridging the respective outputs.

- **XPA 2002: Bridged output mode toggle switch (input channel 1) —**

Use a small screwdriver to toggle the recessed two-position toggle switch to either bridged (up) or unbridged (down) for input channel 1. Bridging takes the signal from Input 1 and outputs the signal from the + terminals of output channels 1 and 2 (see the diagram below).

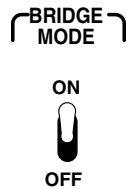

- **XPA 2004: Bridged output mode toggle switch (input channels 1 and 3) —**

Use a small screwdriver to toggle the recessed two-position toggle switch to either bridged (up) or unbridged (down) for the appropriate input channels (see the diagram below).

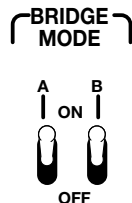

Bridging takes the signal from Input 1 (A) or Input 3 (B) and outputs the combined signals of 400 Watts from the + terminals of output channels 1 and 2 (Bridge A) and channels 3 and 4 (Bridge B).

Bridged Mode Output

XPA 2002 bridged mono output speaker wiring

In bridged mode, the output mode toggle switches for Input 1 (A) or Input 3 (B) or both must be set to the bridged (up) position, as shown below.

For Input 1: The channel 1 "+" output terminal becomes the bridged "+" output terminal and the channel 2 "+" output terminal becomes the bridged "-" output terminal, as shown below.

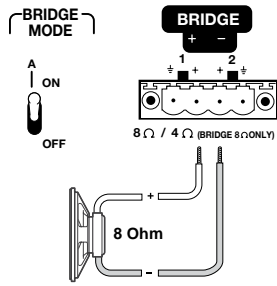

On the input end, only Input 1 is used in bridged mode, as shown below.

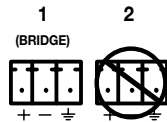

XPA 2002 bridged mono output using parallel speaker wiring

In bridged mode, the output mode toggle switches for Input 1 must be set to the bridged (up) position, as shown below.

The channel 1 "+" output terminal becomes the bridged "+" output terminal and the channel 2 "+" output terminal becomes the bridged "-" output terminal, as shown below.

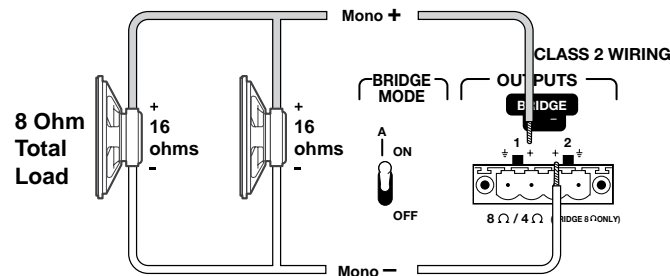

Two 16-ohm speakers wired in parallel equal an 8-ohm load.

On the input end, only Input 1 is used in bridged mode, as shown below.

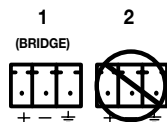

XPA 2004 bridged mono output speaker wiring

In bridged mode, the output mode toggle switches for Input 1 (A) or Input 3 (B) or both must be set to the bridged (up) position, as shown below.

For Input 1: The channel 1 "+" output terminal becomes the bridged "+" output terminal and the channel 2 "+" output terminal becomes the bridged "-" output terminal, as shown below.

For Input 3: The channel 3 "+" output terminal becomes the bridged "+" output terminal and the channel 4 "+" output terminal becomes the bridged "-" output terminal, as shown below.

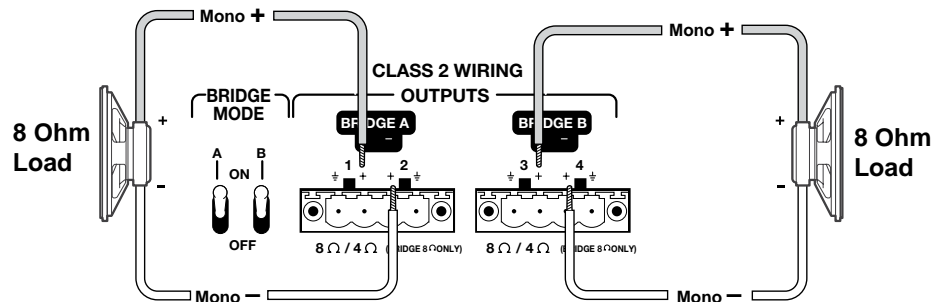

On the input end, only Input 1 or Input 3 or both are used in bridged mode, as shown below.

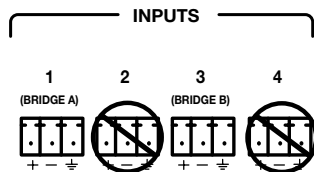

XPA 2004 bridged mono output using parallel speaker wiring

In bridged mode, the output mode toggle switches for Input 1 (A) or Input 3 (B) or both must be set to the bridged (up) position, as shown below.

The channel 1 "+" output terminal becomes the bridged "+" output terminal and the channel 2 "+" output terminal becomes the bridged "-" output terminal, as shown below. Similarly, the channel 3 "+" output terminal becomes the bridged "+" output terminal and the channel 4 "+" output terminal becomes the bridged "-" output terminal, as shown below.

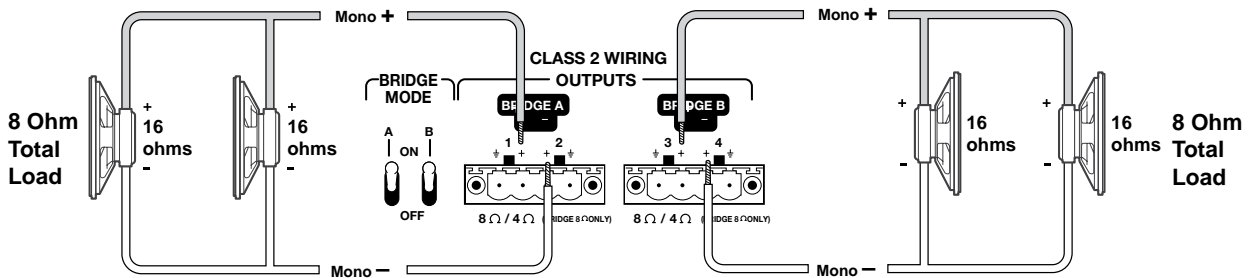

Two 16 ohm speakers wired in parallel equal an 8 ohm load.

On the input end, only Input 1 or Input 3 or both is used in bridged mode, as shown below.

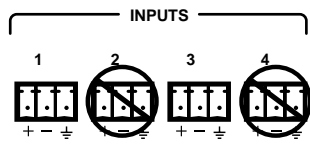

Reference Information

This section discusses the specifications, part numbers, and accessories for the XTRA Series of audio power amplifiers. Topics that are covered, include:

- [Specifications](#)
- [Part Numbers](#)
- [Mounting](#)

Specifications

Audio

Voltage gain

XPA 2002, XPA 2004	23x (27 dB)
XPA 2003C-70V/100V (ch. 1 and 2)	23x (27 dB)
XPA 2002-70V, XPA 2003C-70V (ch. 3 only)	57x (35 dB)
XPA 2002-100V, XPA 2003C-100V (ch. 3 only)	81x (38 dB)
Crosstalk	75 dB (typical) @ 1 kHz
CMRR	75 dB (typical) @ 1 kHz

Audio input

Number/signal type

XPA 2002, XPA 2002-70V, XPA 2002-100V	2 balanced/unbalanced
XPA 2003C-70V, XPA 2003C-100V	3 balanced/unbalanced
XPA 2004	4 balanced/unbalanced

Connectors

XPA 2002, XPA 2002-70V, XPA 2002-100V	(2) 3.5 mm captive screw connectors, 3 pole
XPA 2003C-70V, XPA 2003C-100V	(3) 3.5 mm captive screw connectors, 3 pole
XPA 2004	(4) 3.5 mm captive screw connectors, 3 pole
Impedance	>10k ohms unbalanced/balanced, DC coupled
Nominal level	+4 dBu (1.23 Vrms), balanced
Maximum level.....	+21 dBu (8.69 Vrms), balanced
Input sensitivity	+4 dBu (1.23 Vrms)
Input signal detection threshold	-40 dBu \pm 3 dB, balanced

NOTE: 0 dBu = 0.775 Vrms, 0 dBV = 1 Vrms, 0 dBV \approx 2 dBu

Audio output

Number/signal type

XPA 2002	2 channels, 4 or 8 ohms; or 1 bridged mono, 8 ohms
XPA 2002-70V	2 channels, 70 V
XPA 2002-100V	2 channels, 100 V
XPA 2003C-70V	2 channels, 4 or 8 ohms 1 channel, 70 V
XPA 2003C-100V	2 channels, 4 or 8 ohms 1 channel, 100 V
XPA 2004	4 channels, 4 or 8 ohms; or 2 bridged mono, 8 ohms

Connectors

XPA 2002	(1) 5 mm screw lock captive screw connector, 4 pole
XPA 2002-70V, XPA 2002-100V	(2) 5 mm screw lock captive screw connectors, 2 pole
XPA 2003C-70V, XPA 2003C-100V	(1) 5 mm screw lock captive screw connector, 4 pole (1) 5 mm screw lock captive screw connector, 2 pole
XPA 2004	(2) 5 mm screw lock captive screw connectors, 4 pole

NOTE: These connectors accept wires of 22 AWG to 12 AWG.

Load impedance

XPA 2002-70V	25 ohms minimum
XPA 2002-100V	50 ohms minimum
XPA 2003C-70V	Channel 1 or 2..... 4 ohms minimum Channel 3..... 25 ohms minimum
XPA 2003C-100V	Channel 1 or 2..... 4 ohms minimum Channel 3..... 50 ohms minimum
XPA 2002, XPA 2004	4 ohms (8 ohms if bridged) minimum

Amplifier type Class D

Output power

XPA 2002-70V	200 watts rms per channel, 70 V, 1 kHz, 0.1% THD
XPA 2002-100V	200 watts rms per channel, 100 V, 1 kHz, 0.1% THD
XPA 2003C-70V	Channel 1 or 2 (8 ohm)..... 100 watts rms per channel, 8 ohms, 1 kHz, 0.1% THD Channel 1 or 2 (4 ohm)..... 200 watts rms per channel, 4 ohms, 1 kHz, 0.1% THD Channel 3 (70 V output) 200 watts rms per channel, 70 V, 1 kHz, 0.1% THD
XPA 2003C-100V	Channel 1 or 2 (8 ohm)..... 100 watts rms per channel, 8 ohms, 1 kHz, 0.1% THD Channel 1 or 2 (4 ohm)..... 200 watts rms per channel, 4 ohms, 1 kHz, 0.1% THD Channel 3 (100 V output) .. 200 watts rms per channel, 100 V, 1 kHz, 0.1% THD
XPA 2002, XPA 2004	100 watts rms per channel, 8 ohms, 1 kHz, 0.05% THD 200 watts rms per channel, 4 ohms, 1 kHz, 0.05% THD 400 watts rms (bridged mono), 8 ohms, 1 kHz, 0.05% THD

Frequency response..... 20 Hz to 20 kHz, ± 1 dB

THD + Noise

XPA 2002-70V, XPA 2002-100V	0.1%, 1 kHz, 3 dB below clipping
XPA 2003C-70V, XPA 2003C-100V	Channels 1 and 2: 0.1%, 20 Hz-20 kHz, 8 ohms, 3 dB below clipping Channel 3: 0.1%, 1 kHz, 3 dB below clipping
XPA 2002, XPA 2004	0.1%, 20 Hz to 20 kHz, 8 ohms, 3 dB below clipping

S/N.....	100 dB, 20 Hz - 20 kHz, unweighted
Damping factor	
XPA 2002-70V	>100 @ 25 ohms
XPA 2002-100V	>100 @ 50 ohms
XPA 2003C-70V	
Channel 1 or 2.....	>100 @ 8 ohms
Channel 3.....	>100 @ 25 ohms
XPA 2003C-100V	
Channel 1 or 2.....	>100 @ 8 ohms
Channel 3.....	>100 @ 50 ohms
XPA 2002, XPA 2004	>100 @ 8 ohms
High pass filter	
XPA 2002-70V, XPA 2003C-70V	80 Hz, 12 dB per octave rolloff for 70 V line output (switch selectable)
XPA 2002-100V, XPA 2003C-100V	80 Hz, 12 dB per octave rolloff for 100 V line output (switch selectable)

Control/remote — amplifier

Control port.....	(1) 3.5 mm captive screw connector, 2 pole
Pin configurations	
Standby power control (contact closure)	
	Pin 1 = GND, pin 2 = standby

General

Power	Internal
	Input: 100-240 VAC, 50-60 Hz, 1.5 A
Power consumption at 115 VAC, 60 Hz	
Typical (1/8 power)	
XPA 2002.....	4 ohms (x2): 84.7 watts
	8 ohms (x2): 53.4 watts
XPA 2002-70V	70 V (x2): 84.5 watts
XPA 2002-100V	100 V (x2): 89.6 watts
XPA 2003C-70V	4 ohms (x2) + 70 V: 122.4 watts
	8 ohms (x2) + 70 V: 92.2 watts
XPA 2003C-100V.....	4 ohms (x2) + 100 V: 123.1 watts
	8 ohms (x2) + 100 V: 94.4 watts
XPA 2004.....	4 ohms (x4): 146.5 watts
	8 ohms (x4): 89.3 watts
Quiescent	
XPA 2002.....	10.9 watts
XPA 2002-70V	20.8 watts
XPA 2002-100V	25.1 watts
XPA 2003C-70V	28.9 watts
XPA 2003C-100V.....	28.1 watts
XPA 2004.....	28.7 watts
Standby	<1 watt (triggered by contact closure or after 25 minutes [±5 minutes] with no signal)

Power consumption at 230 VAC, 50 Hz

Typical (1/8 power)

XPA 2002.....	4 ohms (x2): 85.6 watts 8 ohms (x2): 54.4 watts
XPA 2002-70V	70 V (x2): 85.6 watts
XPA 2002-100V	100 V (x2): 90.4 watts
XPA 2003C-70V	4 ohms (x2) + 70 V: 122.4 watts 8 ohms (x2) + 70 V: 92.9 watts
XPA 2003C-100V	4 ohms (x2) + 100 V: 123.3 watts 8 ohms (x2) + 100 V: 95.3 watts
XPA 2004.....	4 ohms (x4): 146.2 watts 8 ohms (x4): 89.9 watts

Quiescent

XPA 2002.....	10.9 watts
XPA 2002-70V	23.1 watts
XPA 2002-100V	26.2 watts
XPA 2003C-70V	29.8 watts
XPA 2003C-100V	28.6 watts
XPA 2004.....	29.0 watts

Standby <1 watt (triggered by contact closure or after 25 minutes [\pm 5 minutes] with no signal)

Temperature/humidity Storage: -40 to +158 °F (-40 to +70 °C) / 10% to 90%, noncondensing
Operating: +32 to +122 °F (0 to +50 °C) / 10% to 90%, noncondensing

Cooling Convection, no vents, with heat sinks on the sides

Thermal dissipation at 115 VAC, 60 Hz

Standby <1 watt (3 BTU/hr)

Idle

XPA 2002.....	10.9 watts (37 BTU/hr)
XPA 2002-70V	20.8 watts (71 BTU/hr)
XPA 2002-100V	25.1 watts (86 BTU/hr)
XPA 2003C-70V	28.9 watts (99 BTU/hr)
XPA 2003C-100V	28.1 watts (96 BTU/hr)
XPA 2004.....	28.7 watts (98 BTU/hr)

1/8 power

XPA 2002.....	4 ohms (x2): 34.7 watts (119 BTU/hr) 8 ohms (x2): 28.4 watts (97 BTU/hr)
XPA 2002-70V	70 V (x2): 34.5 watts (118 BTU/hr)
XPA 2002-100V	100 V (x2): 39.6 watts (135 BTU/hr)
XPA 2003C-70V	4 ohms (x2) + 70 V: 47.4 watts (162 BTU/hr) 8 ohms (x2) + 70 V: 42.2 watts (144 BTU/hr)
XPA 2003C-100V	4 ohms (x2) + 100 V: 48.1 watts (164 BTU/hr) 8 ohms (x2) + 100 V: 44.4 watts (152 BTU/hr)
XPA 2004.....	4 ohms (x4): 46.5 watts (159 BTU/hr) 8 ohms (x4): 39.3 watts (134 BTU/hr)

Thermal dissipation at 230 VAC, 50 Hz

Standby <1 watt (3 BTU/hr)

Idle

XPA 2002.....	10.9 watts (37 BTU/hr)
XPA 2002-70V	23.1 watts (79 BTU/hr)
XPA 2002-100V	26.2 watts (89 BTU/hr)
XPA 2003C-70V	29.8 watts (102 BTU/hr)
XPA 2003C-100V	28.6 watts (98 BTU/hr)

XPA 2004.....	29.0 watts (99 BTU/hr)
1/8 power	
XPA 2002.....	4 ohms (x2): 35.6 watts (122 BTU/hr) 8 ohms (x2): 29.4 watts (100 BTU/hr)
XPA 2002-70V	70 V (x2): 35.6 watts (122 BTU/hr)
XPA 2002-100V	100 V (x2): 40.4 watts (138 BTU/hr)
XPA 2003C-70V	4 ohms (x2) + 70 V: 47.4 watts (162 BTU/hr) 8 ohms (x2) + 70 V: 42.9 watts (146 BTU/hr)
XPA 2003C-100V	4 ohms (x2) + 100 V: 48.3 watts (165 BTU/hr) 8 ohms (x2) + 100 V: 45.3 watts (155 BTU/hr)
XPA 2004.....	4 ohms (x4): 46.2 watts (158 BTU/hr) 8 ohms (x4): 39.9 watts (136 BTU/hr)
Protection	Clip limiting, thermal, short circuit, DC output
Indication	Limiter/Protect LED indicates the onset of clip limiting, thermal cycling, short circuit, or DC output protection
Mounting	
Rack mount	Yes, with included mounting brackets
Enclosure type.....	Metal
Enclosure dimensions	1.7" H x 17.4" W* x 12.0" D (1U high, full rack wide) (4.3 cm H x 44.2 cm W* x 30.5 cm D) *Width excludes rack ears. 19.0" (48.3 cm) W with rack ears.
Product weight.....	9.2 lbs (4.2 kg)
Shipping weight.....	12 lbs (6 kg)
Vibration	ISTA 1A in carton (International Safe Transit Association)
Regulatory compliance	
Safety	CE, c-UL, UL Meets UL 60065, IEC 60065, and BSEN 60065 for AV equipment.
EMI/EMC	CE, CISPR 22 Class B, CISPR 24, C-tick, EN55103-1, EN55103-2, FCC Class B, ICES, VCCI Class B
Environmental	
XPA 2002.....	Complies with the appropriate requirements of CEC, EU code of conduct, RoHS, WEEE
All other models.....	Complies with the appropriate requirements of CEC, ENERGY STAR® (ENERGY STAR qualified amplifier), EU code of conduct, RoHS, WEEE
MTBF	200,000 hours
Warranty.....	3 years parts and labor

NOTE: All nominal levels are at $\pm 10\%$.

NOTE: Specifications are subject to change without notice.

Part Numbers

Included Parts

These items are included with each power amplifier, as indicated below.

Included parts	Replacement part number
XPA 2002 2-channel low impedance power amplifier <i>or</i>	60-563-01
XPA 2002-70V 2-channel 70 V power amplifier <i>or</i>	60-883-02
XPA 2002-100V 2-channel 100 V power amplifier <i>or</i>	60-883-12
XPA 2003C-70V 3-channel low impedance/70 V combo power amplifier <i>or</i>	60-848-01
XPA 2003C-100V 3-channel low impedance/100 V combo power amplifier <i>or</i>	60-848-11
XPA 2004 4-channel low impedance power amplifier	60-563-02
(1) 4-pole screw lock 5 mm captive screw plug (XPA 2002, XPA 2003C-70V, XPA 2003C-100V)	
(2) 4-pole screw lock 5 mm captive screw plug (XPA 2004)	
(1) 2-pole screw lock 5 mm captive screw plug (XPA 2003C-70V, XPA 2003C-100V)	
(2) 2-pole 3.5 mm captive screw plug (XPA 2002-70V, XPA 2002-100V)	
(2) 3-pole 3.5 mm captive screw plug (XPA 2002-70V, XPA 2002-100V)	
(3) 3-pole 3.5 mm captive screw plug (XPA 2003C-70V, XPA 2003C-100V)	
(4) 3-pole 3.5 mm captive screw plug (XPA 2004)	
(1) 2-pole 3.5 mm captive screw plug	
(4) Rubber feet (detached)	
IEC power cord	
Tweezer (small screwdriver)	
User Guide	

Optional Accessories

Description	Part Number
SI 3CT LP Ceiling speakers	42-103-03
SI 3C LP Ceiling speakers	42-103-13
SI 3 Surface mount speakers (black, white)	42-105-02, -03
SI 26CT Ceiling speakers	42-070-03
SI 26 Surface mount speakers (black, white)	42-072-02, -03
SI 28 Surface mount speakers (black, white)	42-073-02, -03
SF 228T Ceiling speakers	42-168-03
FF 120T Ceiling speakers	42-120-13
FF 220T Ceiling speakers	42-141-03
SPK14/1000 Non-Plenum 1000' (300 m) spool	22-152-03
SPK14P/1000 Plenum 1000' (300 m) spool	22-155-03
SPK16/1000 Non-Plenum 1000' (300 m) spool	22-151-03
SPK16P/1000 Plenum 1000' (300 m) spool	22-154-03
SPK18/1000 Non-Plenum 1000' (300 m) spool	22-150-03
SPK18P/1000 Plenum 1000' (300 m) spool	22-153-03

Mounting

The XPA power amplifiers can be set on a table; mounted on a rack shelf; mounted under a desk or other furniture; or mounted in the plenum space above a ceiling-mounted projector.

Tabletop Use

Four self-adhesive rubber feet are included with the audio amplifier.

For tabletop use, attach one foot at each corner of the bottom side of the unit and place the unit in the desired location.

UL Rack Mounting Guidelines

The following Underwriters Laboratories (UL) guidelines pertain to the safe installation of the equipment in a rack.

- 1. Elevated operating ambient temperature** — If installed in a closed or multi-unit rack assembly, the operating ambient temperature of the rack environment may be greater than room ambient temperature. Therefore, install the equipment in an environment compatible with the maximum ambient temperature ($T_{ma} = +122\text{ }^{\circ}\text{F}/+50\text{ }^{\circ}\text{C}$) specified by Extron.
- 2. Reduced air flow** — Install the equipment in a rack so that the amount of air flow required for safe operation of the equipment is not compromised.
- 3. Mechanical loading** — Mount the equipment in the rack so that a hazardous condition is not achieved due to uneven mechanical loading.
- 4. Circuit overloading** — Connect the equipment to the supply circuit and consider the effect that circuit overloading might have on overcurrent protection and supply wiring. Appropriate consideration of equipment nameplate ratings should be used when addressing this concern.
- 5. Reliable earthing (grounding)** — Maintain reliable grounding of rack-mounted equipment. Pay particular attention to supply connections other than direct connections to the branch circuit (for example, use of power strips).

Rack Mounting

The XTRA series of audio amplifiers are housed in rack-mountable metal enclosures with pre-attached mounting ears for standard 19-inch racks. Mount the amplifier, as follows:

- 1.** Disconnect all cables and power sources from the amplifier.
- 2.** Position the amplifier in the mounting rack so that the four slots in the mounting ears are aligned with the rack mounting holes. Use the included mounting screws to fasten the amplifier to the rack, as shown in the following diagram.

WARNING: Never place a load exceeding 40 pounds in weight on top of the rack-mounted amplifier.

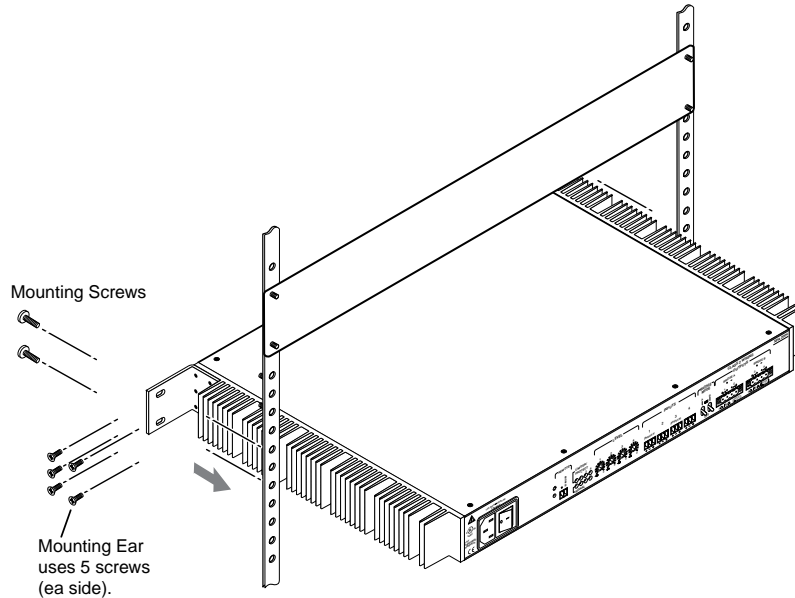

Figure 5. Rack Mounting the Amplifier

Rack Mounting Ventilation

Excessive heat can decrease the optimal lifetime of the power amplifier. An **over temp** indicator LED on the front panel of the amplifier lights red whenever the recommended operating temperature has been exceeded (see "[Front Panel Features and Operation](#)").

To reduce the chances for an **over temp** condition, the XPA should be arranged in a rack environment with up to a maximum of four XPAs stacked together with a minimum of one vent space provided both above and below a stack, as shown below.

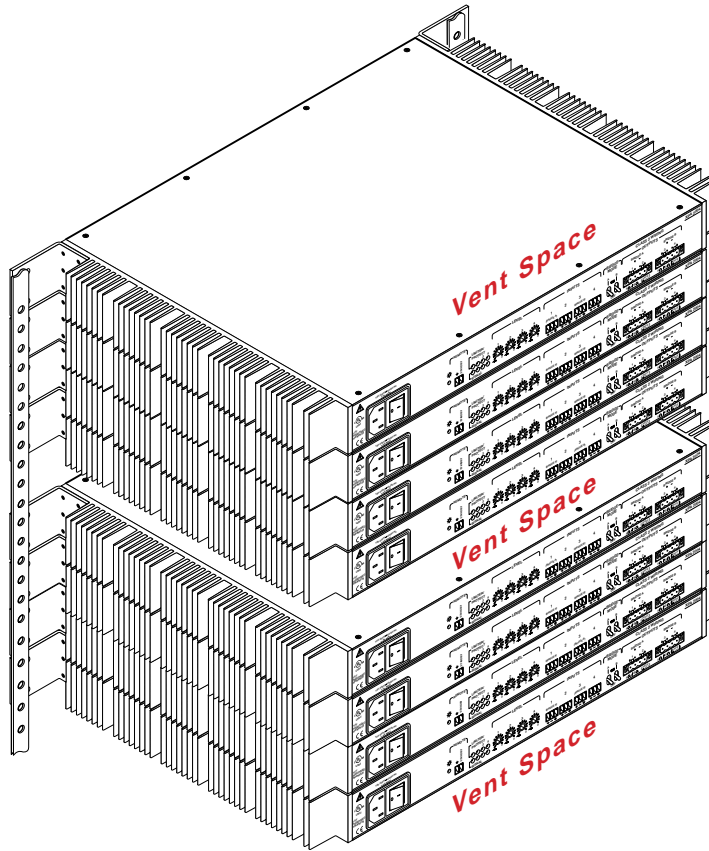

Figure 6. Allow Sufficient Spacing for Adequate Ventilation

Extron® Warranty

Extron Electronics warrants this product against defects in materials and workmanship for a period of three years from the date of purchase. In the event of malfunction during the warranty period attributable directly to faulty workmanship and/or materials, Extron Electronics will, at its option, repair or replace said products or components, to whatever extent it shall deem necessary to restore said product to proper operating condition, provided that it is returned within the warranty period, with proof of purchase and description of malfunction to:

USA, Canada, South America, and Central America:

Extron Electronics
1001 East Ball Road
Anaheim, CA 92805
U.S.A.

Japan:

Extron Electronics, Japan
Kyodo Building, 16 Ichibancho
Chiyoda-ku, Tokyo 102-0082
Japan

Europe, Africa, and the Middle East:

Extron Europe
Hanzeboulevard 10
3825 PH Amersfoort
The Netherlands

China:

Extron China
686 Ronghua Road
Songjiang District
Shanghai 201611
China

Asia:

Extron Asia
135 Joo Seng Road, #04-01
PM Industrial Bldg.
Singapore 368363
Singapore

Middle East:

Extron Middle East
Dubai Airport Free Zone
F12, PO Box 293666
United Arab Emirates, Dubai

This Limited Warranty does not apply if the fault has been caused by misuse, improper handling care, electrical or mechanical abuse, abnormal operating conditions, or if modifications were made to the product that were not authorized by Extron.

NOTE: If a product is defective, please call Extron and ask for an Application Engineer to receive an RA (Return Authorization) number. This will begin the repair process.

USA: (714) 491-1500
Asia: +65.6383.4400

Europe: +31.33.453.4040
Japan: +81.3.3511.7655

Units must be returned insured, with shipping charges prepaid. If not insured, you assume the risk of loss or damage during shipment. Returned units must include the serial number and a description of the problem, as well as the name of the person to contact in case there are any questions.

Extron Electronics makes no further warranties either expressed or implied with respect to the product and its quality, performance, merchantability, or fitness for any particular use. In no event will Extron Electronics be liable for direct, indirect, or consequential damages resulting from any defect in this product even if Extron Electronics has been advised of such damage.

Please note that laws vary from state to state and country to country, and that some provisions of this warranty may not apply to you.

Extron USA - West Headquarters	Extron USA - East	Extron Europe	Extron Asia	Extron Japan	Extron China	Extron Middle East
+800.633.9876 Inside USA/Canada Only	+800.633.9876 Inside USA/Canada Only	+800.3987.6673 Inside Europe Only	+800.7339.8766 Inside Asia Only	+81.3.3511.7655 +81.3.3511.7656 FAX	+400.833.1568 Inside China Only	+971.4.2991800 +971.4.2991880 FAX
+1.714.491.1500 +1.714.491.1517 FAX	+1.919.863.1794 +1.919.863.1797 FAX	+31.33.453.4040 +31.33.453.4050 FAX	+65.6383.4400 +65.6383.4664 FAX		+86.21.3760.1568 +86.21.3760.1566 FAX	

Free Manuals Download Website

<http://myh66.com>

<http://usermanuals.us>

<http://www.somanuals.com>

<http://www.4manuals.cc>

<http://www.manual-lib.com>

<http://www.404manual.com>

<http://www.luxmanual.com>

<http://aubethermostatmanual.com>

Golf course search by state

<http://golfingnear.com>

Email search by domain

<http://emailbydomain.com>

Auto manuals search

<http://auto.somanuals.com>

TV manuals search

<http://tv.somanuals.com>