

User's Manual



CVEQ1, CVEQ1 WM, CVEQ1 AAP 1-Input, 1-Output Equalizing Composite Video Line Drivers

68-544-01 **Rev. B**
Printed in the USA
08 02



1230 South Lewis Street
Anaheim, CA 92805
USA
714.491.1500
Fax 714.491.1517

Beeldschermweg 6C
3821 AH Amersfoort
The Netherlands
+31.33.453.4040
Fax +31.33.453.4050

135 Joo Seng Road, #04-01
PM Industrial Building
Singapore 368363
+65.6383.4400
Fax +65.6383.4664

Daisan DMJ Building 6F
3-9-1 Kudan Minami
Chiyoda-ku, Tokyo 102-0074 Japan
+81.3.3511.7655
Fax +81.3.3511.7656

Precautions

Safety Instructions • English



This symbol is intended to alert the user of important operating and maintenance (servicing) instructions in the literature provided with the equipment.



This symbol is intended to alert the user of the presence of uninsulated dangerous voltage within the product's enclosure that may present a risk of electric shock.

Caution

Read Instructions • Read and understand all safety and operating instructions before using the equipment.

Retain Instructions • The safety instructions should be kept for future reference.

Follow Warnings • Follow all warnings and instructions marked on the equipment or in the user information.

Avoid Attachments • Do not use tools or attachments that are not recommended by the equipment manufacturer because they may be hazardous.

Consignes de Sécurité • Français



Ce symbole sert à avertir l'utilisateur que la documentation fournie avec le matériel contient des instructions importantes concernant l'exploitation et la maintenance (réparation).



Ce symbole sert à avertir l'utilisateur de la présence dans le boîtier de l'appareil de tensions dangereuses non isolées posant des risques d'électrocution.

Attention

Lire les instructions • Prendre connaissance de toutes les consignes de sécurité et d'exploitation avant d'utiliser le matériel.

Conservier les instructions • Ranger les consignes de sécurité afin de pouvoir les consulter à l'avenir.

Respecter les avertissements • Observer tous les avertissements et consignes marqués sur le matériel ou présentés dans la documentation utilisateur.

Eviter les pièces de fixation • Ne pas utiliser de pièces de fixation ni d'outils non recommandés par le fabricant du matériel car cela risquerait de poser certains dangers.

Sicherheitsanleitungen • Deutsch



Dieses Symbol soll dem Benutzer in der im Lieferumfang enthaltenen Dokumentation besonders wichtige Hinweise zur Bedienung und Wartung (Instandhaltung) geben.



Dieses Symbol soll den Benutzer darauf aufmerksam machen, daß im Inneren des Gehäuses dieses Produktes gefährliche Spannungen, die nicht isoliert sind und die einen elektrischen Schock verursachen können, herrschen.

Achtung

Lesen der Anleitungen • Bevor Sie das Gerät zum ersten Mal verwenden, sollten Sie alle Sicherheits- und Bedienungsanleitungen genau durchlesen und verstehen.

Aufbewahren der Anleitungen • Die Hinweise zur elektrischen Sicherheit des Produktes sollten Sie aufbewahren, damit Sie im Bedarfsfall darauf zurückgreifen können.

Befolgen der Warnhinweise • Befolgen Sie alle Warnhinweise und Anleitungen auf dem Gerät oder in der Benutzerdokumentation.

Keine Zusatzgeräte • Verwenden Sie keine Werkzeuge oder Zusatzgeräte, die nicht ausdrücklich vom Hersteller empfohlen wurden, da diese eine Gefahrenquelle darstellen können.

Instrucciones de seguridad • Español



Este símbolo se utiliza para advertir al usuario sobre instrucciones importantes de operación y mantenimiento (o cambio de partes) que se desean destacar en el contenido de la documentación suministrada con los equipos.



Este símbolo se utiliza para advertir al usuario sobre la presencia de elementos con voltaje peligroso sin protección aislante, que puedan encontrarse dentro de la caja o alojamiento del producto, y que puedan representar riesgo de electrocución.

Precaución

Leer las instrucciones • Leer y analizar todas las instrucciones de operación y seguridad, antes de usar el equipo.

Conservar las instrucciones • Conservar las instrucciones de seguridad para futura consulta.

Obedecer las advertencias • Todas las advertencias e instrucciones marcadas en el equipo o en la documentación del usuario, deben ser obedecidas.

Evitar el uso de accesorios • No usar herramientas o accesorios que no sean específicamente recomendados por el fabricante, ya que podrían implicar riesgos.

Warning

Power sources • This equipment should be operated only from the power source indicated on the product. This equipment is intended to be used with a main power system with a grounded (neutral) conductor. The third (grounding) pin is a safety feature, do not attempt to bypass or disable it.

Power disconnection • To remove power from the equipment safely, remove all power cords from the rear of the equipment, or the desktop power module (if detachable), or from the power source receptacle (wall plug).

Power cord protection • Power cords should be routed so that they are not likely to be stepped on or pinched by items placed upon or against them.

Servicing • Refer all servicing to qualified service personnel. There are no user-serviceable parts inside. To prevent the risk of shock, do not attempt to service this equipment yourself because opening or removing covers may expose you to dangerous voltage or other hazards.

Slots and openings • If the equipment has slots or holes in the enclosure, these are provided to prevent overheating of sensitive components inside. These openings must never be blocked by other objects.

Lithium battery • There is a danger of explosion if battery is incorrectly replaced. Replace it only with the same or equivalent type recommended by the manufacturer. Dispose of used batteries according to the manufacturer's instructions.

Avertissement

Alimentations • Ne faire fonctionner ce matériel qu'avec la source d'alimentation indiquée sur l'appareil. Ce matériel doit être utilisé avec une alimentation principale comportant un fil de terre (neutre). Le troisième contact (de mise à la terre) constitue un dispositif de sécurité : n'essayez pas de le contourner ni de le désactiver.

Déconnexion de l'alimentation • Pour mettre le matériel hors tension sans danger, déconnectez tous les cordons d'alimentation de l'arrière de l'appareil ou du module d'alimentation de bureau (s'il est amovible) ou encore de la prise secteur.

Protection du cordon d'alimentation • Acheminer les cordons d'alimentation de manière à ce que personne ne risque de marcher dessus et à ce qu'ils ne soient pas écrasés ou pincés par des objets.

Réparation-maintenance • Faire exécuter toutes les interventions de réparation-maintenance par un technicien qualifié. Aucun des éléments internes ne peut être réparé par l'utilisateur. Afin d'éviter tout danger d'électrocution, l'utilisateur ne doit pas essayer de procéder lui-même à ces opérations car l'ouverture ou le retrait des couvercles risquent de l'exposer à de hautes tensions et autres dangers.

Fentes et orifices • Si le boîtier de l'appareil comporte des fentes ou des orifices, ceux-ci servent à empêcher les composants internes sensibles de surchauffer. Ces ouvertures ne doivent jamais être bloquées par des objets.

Lithium Batterie • Il a danger d'explosion s'il y a remplacement incorrect de la batterie. Remplacer uniquement avec une batterie du même type ou d'un type équivalent recommandé par le constructeur. Mettre au rebut les batteries usagées conformément aux instructions du fabricant.

Vorsicht

Stromquellen • Dieses Gerät sollte nur über die auf dem Produkt angegebene Stromquelle betrieben werden. Dieses Gerät wurde für eine Verwendung mit einer Hauptstromleitung mit einem geerdeten (neutralen) Leiter konzipiert. Der dritte Kontakt ist für einen Erdanschluß, und stellt eine Sicherheitsfunktion dar. Diese sollte nicht umgangen oder außer Betrieb gesetzt werden.

Stromunterbrechung • Um das Gerät auf sichere Weise vom Netz zu trennen, sollten Sie alle Netzkabel aus der Rückseite des Gerätes, aus der externen Stromversorgung (falls dies möglich ist) oder aus der Wandsteckdose ziehen.

Schutz des Netzkabels • Netzkabel sollten stets so verlegt werden, daß sie nicht im Weg liegen und niemand darauf treten kann oder Objekte darauf- oder unmittelbar dagegen gestellt werden können.

Wartung • Alle Wartungsmaßnahmen sollten nur von qualifiziertem Servicepersonal durchgeführt werden. Die internen Komponenten des Gerätes sind wartungsfrei. Zur Vermeidung eines elektrischen Schocks versuchen Sie in keinem Fall, dieses Gerät selbst öffnen, da beim Entfernen der Abdeckungen die Gefahr eines elektrischen Schlags und/oder andere Gefahren bestehen.

Schlitze und Öffnungen • Wenn das Gerät Schlitze oder Löcher im Gehäuse aufweist, dienen diese zur Vermeidung einer Überhitzung der empfindlichen Teile im Inneren. Diese Öffnungen dürfen niemals von anderen Objekten blockiert werden.

Litium-Batterie • Explosionsgefahr, falls die Batterie nicht richtig ersetzt wird. Ersetzen Sie verbrauchte Batterien nur durch den gleichen oder einen vergleichbaren Batterietyp, der auch vom Hersteller empfohlen wird. Entsorgen Sie verbrauchte Batterien bitte gemäß den Herstelleranweisungen.

Advertencia

Alimentación eléctrica • Este equipo debe conectarse únicamente a la fuente (tipo de alimentación) eléctrica indicada en el equipo. La alimentación eléctrica de este equipo debe provenir de un sistema de distribución general con conductor neutro a tierra. La tercera pata (puesta a tierra) es una medida de seguridad, no puede ser eliminada.

Desconexión de alimentación eléctrica • Para desconectar con seguridad la acometida de alimentación eléctrica al equipo, desenchufar todos los cables de alimentación en el panel trasero del equipo, o desenchufar el módulo de alimentación (si fuera independiente), o desenchufar el cable del receptáculo de la pared.

Protección del cables de alimentación • Los cables de alimentación eléctrica se deben instalar en lugares donde no sean pisados ni apretados por objetos que se puedan apoyar sobre ellos.

Reparaciones/mantenimiento • Solicitar siempre los servicios técnicos de personal calificado. En el interior no hay partes a las que el usuario deba acceder. Para evitar riesgo de electrocución, no intentar personalmente la reparación/mantenimiento de este equipo, ya que al abrirlo o extraer las tapas puede quedar expuesto a voltajes peligrosos u otros riesgos.

Ranuras y aberturas • Si el equipo posee ranuras o orificios en su caja/alojamiento, es para evitar el sobrecalentamiento de componentes internos sensibles. Estas aberturas nunca se deben obstruir con otros objetos.

Batería de litio • Existe riesgo de explosión si esta batería se coloca en la posición incorrecta. Cambiar esta batería únicamente con el mismo tipo (o su equivalente) recomendado por el fabricante. Desachar las baterías usadas siguiendo las instrucciones del fabricante.

FCC Class A Notice

Note: This equipment has been tested and found to comply with the limits for a Class A digital device, pursuant to part 15 of the FCC Rules. These limits are designed to provide reasonable protection against harmful interference when the equipment is operated in a commercial environment. This equipment generates, uses and can radiate radio frequency energy and, if not installed and used in accordance with the instruction manual, may cause harmful interference to radio communications. Operation of this equipment in a residential area is likely to cause harmful interference, in which case the user will be required to correct the interference at his own expense.

Note: This unit was tested with shielded cables on the peripheral devices. Shielded cables must be used with the unit to ensure compliance.

Extron's Warranty

Extron Electronics warrants this product against defects in materials and workmanship for a period of three years from the date of purchase. In the event of malfunction during the warranty period attributable directly to faulty workmanship and/or materials, Extron Electronics will, at its option, repair or replace said products or components, to whatever extent it shall deem necessary to restore said product to proper operating condition, provided that it is returned within the warranty period, with proof of purchase and description of malfunction to:

USA, Canada, South America, and Central America:

Extron Electronics
1230 South Lewis Street
Anaheim, CA 92805, USA

Europe, Africa, and the Middle East:

Extron Electronics, Europe
Beeldschermweg 6C
3821 AH Amersfoort
The Netherlands

Asia:

Extron Electronics, Asia
135 Joo Seng Road, #04-01
PM Industrial Bldg.
Singapore 368363

This Limited Warranty does not apply if the fault has been caused by misuse, improper handling care, electrical or mechanical abuse, abnormal operating conditions or non-Extron authorized modification to the product.

If it has been determined that the product is defective, please call Extron and ask for an Applications Engineer at (714) 491-1500 (USA), 31.33.453.4040 (Europe), or 65.6383.4400 (Asia) to receive an RA# (Return Authorization number). This will begin the repair process as quickly as possible.

Units must be returned insured, with shipping charges prepaid. If not insured, you assume the risk of loss or damage during shipment. Returned units must include the serial number and a description of the problem, as well as the name of the person to contact in case there are any questions.

Extron Electronics makes no further warranties either expressed or implied with respect to the product and its quality, performance, merchantability, or fitness for any particular use. In no event will Extron Electronics be liable for direct, indirect, or consequential damages resulting from any defect in this product even if Extron Electronics has been advised of such damage.

Please note that laws vary from state to state and country to country, and that some provisions of this warranty may not apply to you.

Table of Contents

Chapter 1 • Introduction	1-1
About the CVEQ1, CVEQ1 WM, and CVEQ1 AAP	1-2
Features	1-2
Chapter 2 • Installation, Setup, Operation	2-1
Installation Overview	2-2
UL Requirements	2-3
Preparing the Site and Installing the Wall Box	2-3
Front Panel Features and Cabling	2-6
Rear/Bottom/Side Panel Features and Cabling	2-7
Top/Side Panel Features and Adjustments	2-9
Mounting the CVEQ1 AAP	2-11
Mounting the CVEQ1 WM	2-12
Appendix A • Specifications, Part Numbers, and Accessories	A-1
Specifications	A-2
Included Parts	A-4
Accessories	A-4
Cables	A-4
Appendix B • Dimensions and Templates	B-1
Dimensions	B-2
Cut-out Template	B-3

All trademarks mentioned in this manual are the properties of their respective owners.

68-544-01 **Rev. B**
Printed in the USA
08 02



1 Chapter One

Introduction

About the CVEQ1, CVEQ1 WM, and CVEQ1 AAP

Features

About the CVEQ1, CVEQ1 WM, and CVEQ1 AAP

The Extron CVEQ1 is a one-input, one-output, composite video line driver. It features a 30 MHz ($< \pm 0.5\text{dB}$) video bandwidth.

It accepts one composite video input on a female BNC connector and one stereo audio input on a pair of female RCA connectors. One female BNC connector provides equalized video output, and a five-pole captive screw connector provides for stereo audio output.

The Extron CVEQ1 AAP is identical to the CVEQ1, except that it is designed to be mounted in a double-space height architectural adapter plate bracket (in a device's faceplate or in an AAP wallplate) for installation into a wall or furniture.

The CVEQ1 WM shares the features of the other two models, but it has a 1-gang faceplate for installation into a UL-approved electrical wall box set into a wall or furniture.

In this manual "CVEQ1", and "line driver" will be used to refer to all models interchangeably unless otherwise noted.

Features

Stereo audio — Unbalanced stereo audio input can be output as balanced or unbalanced stereo audio.

Gain adjustment — All models offer a video gain adjustment with a range of -6dB to +6dB.

Equalization adjustment — Each model also features an equalization adjustment that changes the level and peaking of the output signal to compensate for use of long cables. The CVEQ1 series line drivers can drive video signals through up to 1000 feet (304.8 meters) of Extron SHR cable.



Chapter Two

Installation, Setup, Operation

Installation Overview

UL Requirements

Preparing the Site and Installing the Wall Box

Front Panel Features and Cabling

Rear/Bottom/Side Panel Features and Cabling

Top/Side Panel Features and Adjustments

Mounting the CVEQ1 AAP

Mounting the CVEQ1 WM

Installation Overview

CAUTION Installation and service must be performed by authorized personnel only. The CVEQ1 AAP and CVEQ1 WM must be used with UL approved electrical boxes. See “UL Requirements”, page 2-3.

To install and set up a CVEQ1, follow these steps:

- 1 Turn the input and output devices off and unplug their power cords.
- 2 For the CVEQ1 AAP,
 - A. Determine the installation location.
 - B. If applicable, follow the site preparation (hole cutting, electrical box installation, and cable preparation) instructions included with the device or AAP wallplate into which the CVEQ1 AAP will be installed.
 - C. Attach the CVEQ1 AAP to the Extron device faceplate or AAP wallplate.
- 3 For the CVEQ1 WM,
 - A. Determine the installation location.
 - B. Prepare the site (cut the hole, install the electrical box, and prepare the cable).
- 4 Attach output cables to the rear (CVEQ1)/bottom (CVEQ1 AAP)/side (CVEQ1 WM) panel of the line driver and to the output devices. See “Rear/Bottom/Side Panel Features and Cabling” in this chapter.
- 5 Attach input cables to the input devices and to the line driver’s front panel connectors. See “Front Panel Features and Cabling” in this chapter.
- 6 Connect power cords and turn on the output devices (projector/monitor, speakers), buffer, and input devices.
- 7 The picture should appear, and sound should be audible. If not, ensure that all devices are plugged in and receiving power. Check the cabling; make adjustments as needed.
- 8 While watching the display, adjust the video gain and equalization by using the rotary Gain and Equalize controls. An oscilloscope can be used to achieve a more precise adjustment. See page 2-9.
- 9 For the CVEQ1 AAP or CVEQ1 WM,
 - A. Disconnect the line driver’s power supply at the source end (not at the line driver).

- B. Disconnect the input and output devices’ power.
- C. For the CVEQ1 WM, secure the faceplate onto the UL-approved electrical wall box in the wall or furniture.
For the CVEQ1 AAP, secure the wallplate/faceplate that the CVEQ1 AAP is attached to onto the UL-approved electrical wall box in the wall or furniture.
- D. Restore power to the line driver and to input and output devices.

UL Requirements

The Underwriters Laboratories (UL) requirements listed below pertain to the installation of the CVEQ1 WM and CVEQ1 AAP.

1. These units are not to be connected to a centralized DC power source or used beyond their rated voltage range.

NOTE The Extron P/S 100, P/S 150, and other Extron power supplies may be used with the CVEQ.

2. These units must be installed in UL listed junction boxes.

NOTE The UL approved electrical wall box (junction box) is not included with the CVEQ; the installer is responsible for obtaining and installing the box.

3. These units must be installed with conduit in accordance with the National Electrical Code.

Preparing the Site and Installing the Wall Box

Choose a location that will allow cable runs without interference. Allow enough depth for both the wall box and the cables. You may need to install the cables into the wall, furniture, or conduits before installing the line driver.

- The CVEQ1 AAP can be installed in an Extron two-gang, four-gang, or half rack width AAP Architectural Adapter Plate or in the faceplate of another Extron device that accepts AAP plates, such as an interface or distribution amplifier. Refer to the mounting instructions for the adapter plate or device.
- The CVEQ1 WM can be installed in a standard one-gang electrical wall box that is at least 2.5” deep. An optional one-gang mud ring is also available.

The installation must conform to national and local electrical codes and to the line driver’s size requirements. A dimensional drawing of the CVEQ1 WM and an actual-size cut-out template are provided in appendix B of this manual.

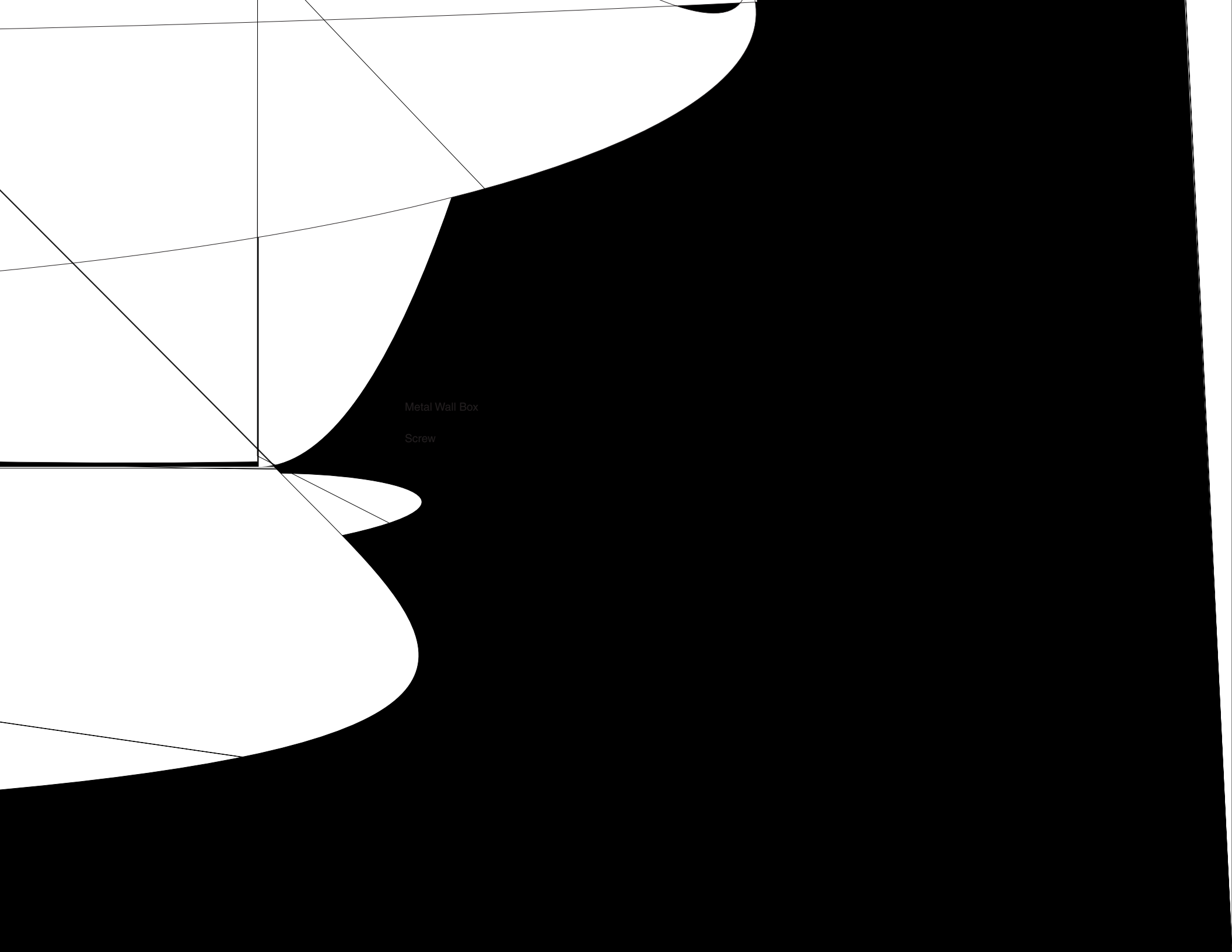

Metal Wall Box

Screw

Rear/Bottom/Side Panel Features and Cabling

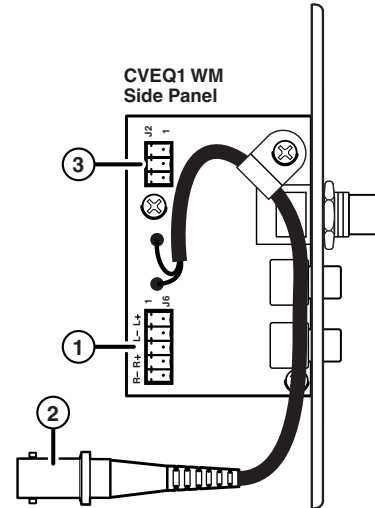
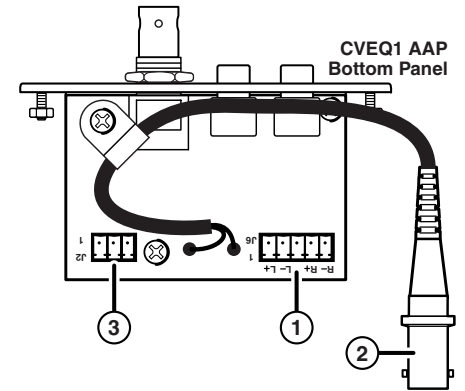
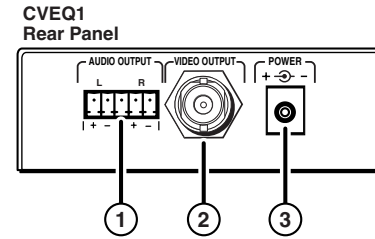

- ① **Audio output connector** — Cable an audio device to the line driver via this female 5-pole captive screw connector. Wire the male connector as shown below.

Unbalanced Audio Output



CAUTION Connect the sleeve to ground (Gnd). Connecting the sleeve to a negative (-) terminal will damage the audio output circuits.

Balanced Audio Output

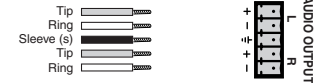

The CVEQ1 WM and CVEQ1 AAP have a female captive screw connector instead of a jack for connecting an external power source. Wire the power connection as shown at right.

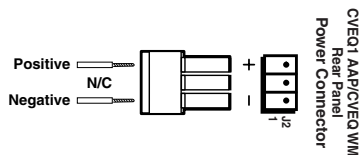

Top/Side Panel Features and Adjustments

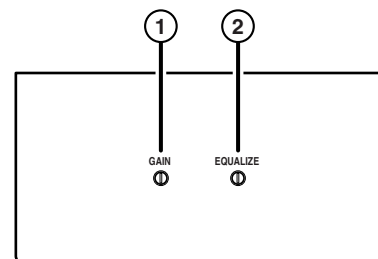

CVEQ1
Top Panel

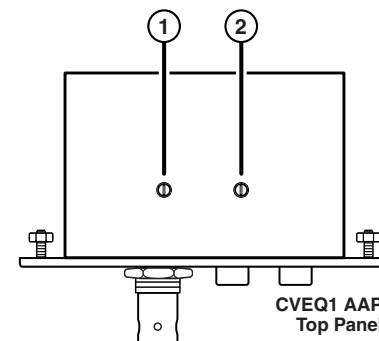

CVEQ1 AAP
Top Panel

NOTE Adjust the gain and equalization before installing the CVEQ1 AAP or CVEQ1 WM into a wall or furniture, as the gain and equalization adjustment controls will be inaccessible after installation.

- ① **Gain adjustment control** — This control adjusts picture brightness by compensating for signal amplitude loss caused by cable resistance. To adjust the output gain, view the display while using a small, flat-blade screwdriver to rotate this two-turn potentiometer. This control produces a gain adjustment ranging from -6dB to +6dB. Select the setting that gives the best picture brightness.

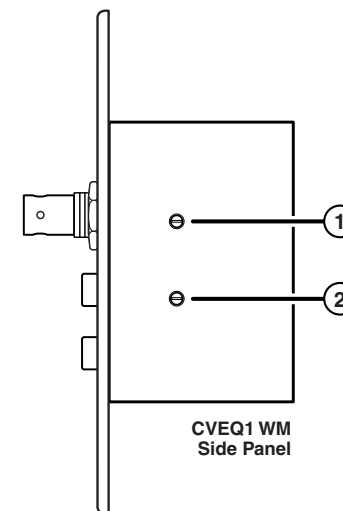

CVEQ1 WM
Side Panel

You can judge the adjustment visually by looking at the display. For a more precise setting you can use an oscilloscope or a waveform monitor connected to the far end of the output cable, and adjust the gain so that the level at the waveform monitor is 100 IRE.

- ② **Equalization adjustment control (Equalize)** — To adjust the output level and peaking to get a sharp picture, rotate this two-turn potentiometer. This adjustment

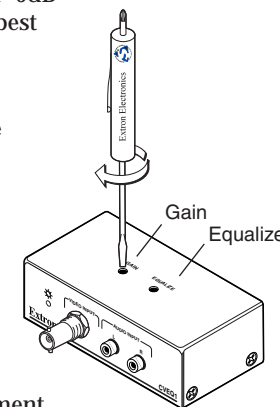

changes the level and peaking of the output signal to compensate for capacitance caused by up to 1000 feet (304.8 meters) of Extron SHR cable.

Use a small, flat-blade screwdriver to rotate this control. View the display and select the setting that gives the sharpest picture. For a more precise setting you can use an oscilloscope or a waveform monitor connected to the far end of the output cable, and adjust the equalization so that the color burst ranges between -20 IRE and +20 IRE.

NOTE *The Equalize control is a potentiometer with a soft mechanical stop at the high and the low end. If you have reached the high or low end of the adjustment, the potentiometer makes a clicking sound as you turn it, and no change is apparent on the display.*

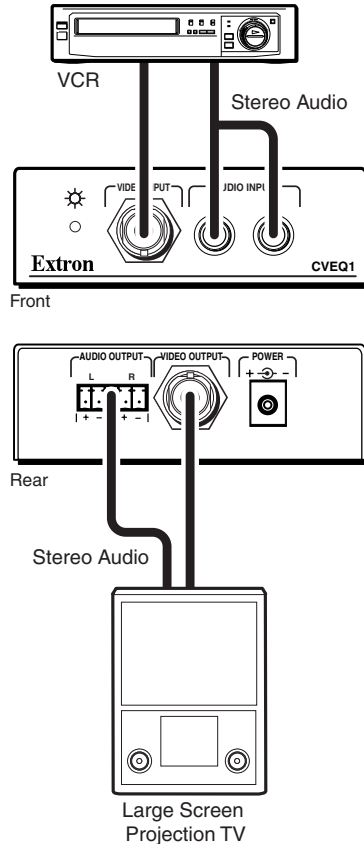

A typical CVEQ1 application

Mounting the CVEQ1 AAP

The CVEQ1 AAP and any other adapter plates must be attached to a device's faceplate or an AAP wallplate and cabled before the device or wallplate is installed in a wall or furniture. The screws needed for installing the CVEQ1 AAP are built into its front panel, so no additional screws will be needed.

1. Insert the CVEQ1 AAP's screws through the holes in the faceplate or AAP wallplate. Secure the line driver to the faceplate/wallplate with the provided captive washers and #4-40 nuts.

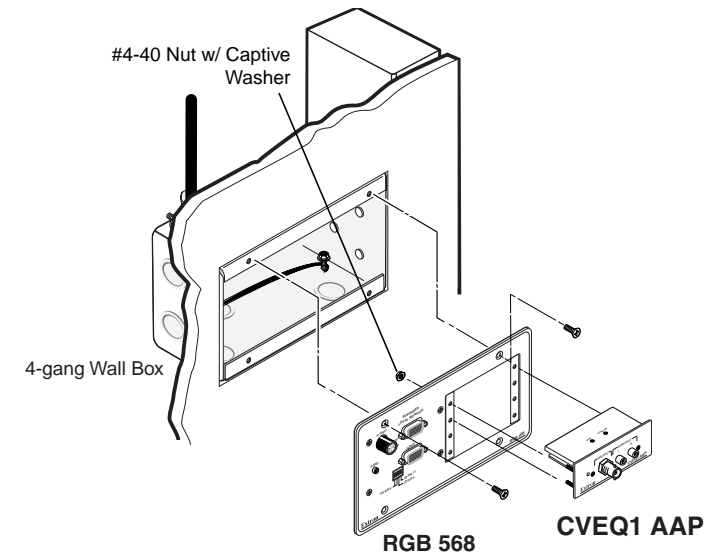

Mounting the CVEQ1 AAP to an interface or wallplate and into a wall box

2. Follow steps 4 through 9 in the "Installation Overview" section of this chapter.

Mounting the CVEQ1 WM

The CVEQ1 WM must have output cables connected before it is installed in a wall or furniture. Secure the CVEQ1 WM to wall box as shown below.

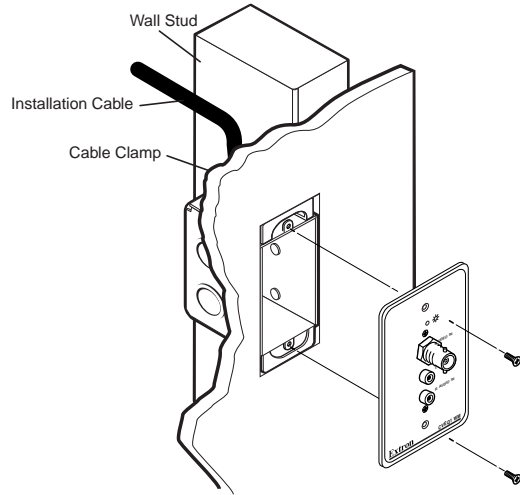

Mounting the CVEQ1 WM into a wall box



Appendix A

Specifications, Part Numbers, and Accessories

Specifications

Included Parts

Accessories

Cables

Specifications, Part Numbers, Accessories

Specifications

Video

Gain	Adjustable 0.5V to 2.0V $\pm 10\%$ (-6dB to +6dB) with input at 1 volt
Equalization/peaking gain	4.5dB max. @ 8 MHz
Bandwidth	30 MHz (< ± 0.5 dB)
Differential phase error	1°, 3.58 MHz
Differential gain error	0.07%, 3.58 MHz

Video input

Number/signal type	1 composite video
Connectors	1 female BNC
Nominal level	1V p-p
Minimum/maximum levels	Analog, 0.3V to 2.0V p-p with no offset at unity gain
Impedance	75 ohms
Return loss.....	30dB @ 5 MHz

Video output

Number/signal type	1 equalized composite video
Connectors	1 female BNC
Nominal level	1V p-p
Minimum/maximum levels	0.3V to 2.0V p-p
Impedance	75 ohms
Return loss.....	<-30dB @ 5 MHz
DC offset	± 50 mV maximum with input at 0 offset

Sync

Standards	NTSC 3.58, NTSC 4.43, PAL, SECAM
-----------------	----------------------------------

Audio

Gain	Wired for unbalanced output: 0dB Wired for balanced output: +6dB
Frequency response	20 Hz to 20 kHz, ± 0.5 dB
THD + Noise	0.025% @ 1 kHz, 0.020% @ 20 kHz at nominal level
S/N	>86dB at output 6 dB, balanced
Stereo channel separation	>75dB @ 20 Hz to 20 kHz

Audio input

Number/signal type	1 stereo unbalanced
Connectors	2 RCA female
Impedance	>10 kohms unbalanced, DC coupled
Nominal level	-10dBV (316mV)
Maximum level	+6dBu, (balanced or unbalanced) at 1% THD+N

Audio output

Number/signal type	1 stereo, balanced/unbalanced
Connectors	
CVEQ1	1 3.5 mm captive screw connector, 5 pole
CVEQ1 AAP	1 3.5 mm direct insertion captive screw connector, 5 pole
Impedance	50 ohms unbalanced, 100 ohms balanced
Nominal level	-2dBu (632mV), balanced output
Maximum level (600 ohm)	> +5.5dBm, balanced or unbalanced at 1% THD+N

General

Power	100VAC to 240VAC, 50/60 Hz, 5 watts, external; 12VDC, 1 A power supply. Product requires 0.42 A.
Temperature/humidity	Storage -40° to +158°F (-40° to +70°C) / 10% to 90%, non-condensing Operating +32° to +122°F (0° to +50°C) / 10% to 90%, non-condensing
Rack mount	No
Enclosure type	Metal
Enclosure dimensions	
CVEQ1	1.2" H x 3.5" W x 1.8" D 3.0 cm H x 8.9 cm W x 4.6 cm D (Depth excludes connectors.)
CVEQ1 AAP	
Plate	1.4" H x 3.5" W x 0.1" D (2.8 cm H x 8.9 cm W x 0.3 cm D) (double-space high AAP plate)
Circuit board	1.1" H x 2.7" W x 1.7" D (2.8 cm H x 6.9 cm W x 4.3 cm D) (Height includes connectors, but not cables.)
CVEQ1 WM	
Plate	4.5" H x 2.8" W x 0.1" D (11.4 cm H x 7.1 cm W x 0.3 cm D) (1 gang)
Circuit board	2.7" H x 1.1" W x 1.7" D (6.9 cm H x 2.8 cm W x 4.3 cm D) (Width includes connectors, but not cables.)
Product weight	
CVEQ1, CVEQ1 AAP	0.2 lbs (0.1 kg)
CVEQ1 WM	0.3 lbs (0.1 kg)
Shipping weight	
CVEQ1, CVEQ1 AAP	2 lbs (0.9 kg)
CVEQ1 WM	3 lbs (1.4 kg)
Vibration	ISTA/NSTA 1A in carton (International Safe Transit Association)
Listings	UL, CUL

Specifications, Parts, and Accessories, cont'd

Compliances	CE, FCC Class A
MTBF	30,000 hours
Warranty	3 years parts and labor

NOTE Specifications are subject to change without notice.

Included Parts

These items are included in each order for a CVEQ1, CVEQ1 AAP, or CVEQ1 WM:

Included parts	Part number
CVEQ1	60-360-02
or CVEQ1 AAP (gray, black, white)	70-146-02, -12, -22
or CVEQ1 WM (gray, black, white)	60-435-02, -12, -22
12VDC, 1A external power supply	28-071-02
CVEQ1/CVEQ1 AAP/CVEQ1 WM User's Manual	68-544-01

Accessories

Accessories	Part number
BNCM-RCAF adapter	10-264-01
3.5 mm 5-pole captive screw connector	10-319-10
AAP 102 2 gang wall plate (gray, black, white)	60-300-01,-02,-03
AAP 104 4 gang wall plate (gray, black, white)	60-301-01,-02,-03
AAP 201 half rack width, 1U high faceplate	60-302-01
AAP 202 half rack width, 2U high faceplate	60-303-01
1-gang mounting bracket/mud ring (gray, black, white)	70-086-05, -15, -25
P/S 100 universal power supply	60-357-01
P/S 150 universal power supply	60-432-01

Cables

Super high resolution cables	Part number
SHR-1, 6' (1.8 m), 12' (3.7 m)	26-383-12, -07
SHR-1, 50' (15.2 m), 100' (30.5 m)	26-383-05, -03
SHR-1, 500' (152.4 m) bulk	22-098-02



CVEQ1, CVEQ1 WM, CVEQ1 AAP

Appendix B

Dimensions and Templates

Dimensions

Cut-out Template

Dimensions and Templates

Dimensions

NOTE The dimensions drawing is not 100% of the actual size.

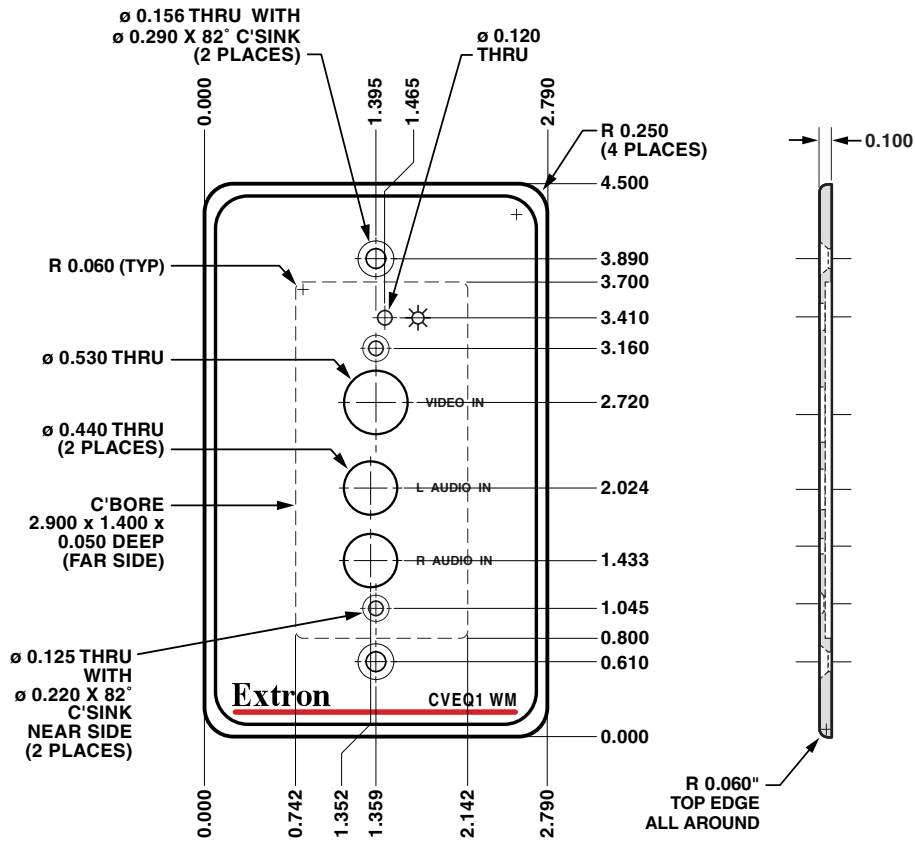

Cut-out Template

CVEQ1 WM cut-out template

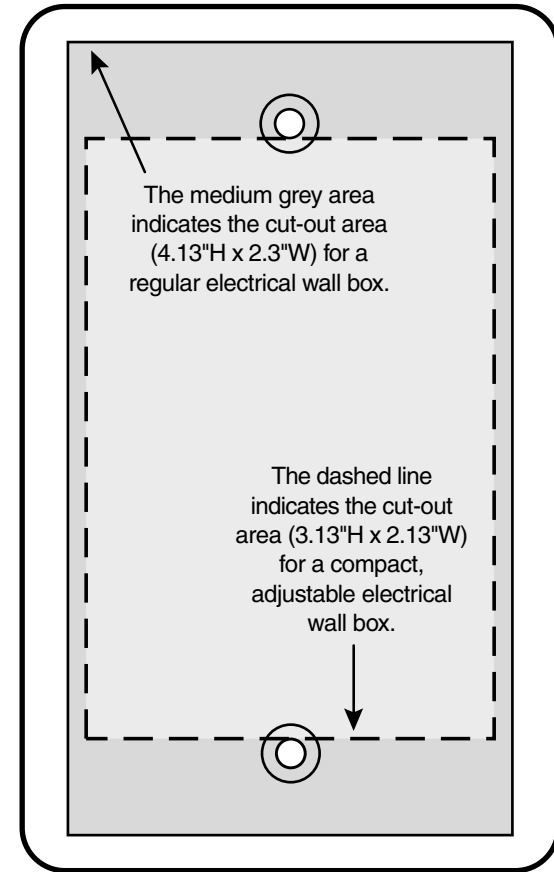

Dimensions, Templates, cont'd

Free Manuals Download Website

<http://myh66.com>

<http://usermanuals.us>

<http://www.somanuals.com>

<http://www.4manuals.cc>

<http://www.manual-lib.com>

<http://www.404manual.com>

<http://www.luxmanual.com>

<http://aubethermostatmanual.com>

Golf course search by state

<http://golfingnear.com>

Email search by domain

<http://emailbydomain.com>

Auto manuals search

<http://auto.somanuals.com>

TV manuals search

<http://tv.somanuals.com>