

# DTP HDMI 301

## HDMI Twisted Pair Extender



**Extron® Electronics**  
INTERFACING, SWITCHING AND CONTROL

68-2156-01 Rev. A  
12 11

## Safety Instructions • English



This symbol is intended to alert the user of important operating and maintenance (servicing) instructions in the literature provided with the equipment.



This symbol is intended to alert the user of the presence of uninsulated dangerous voltage within the product's enclosure that may present a risk of electric shock.

### Caution

**Read Instructions** • Read and understand all safety and operating instructions before using the equipment.

**Retain Instructions** • The safety instructions should be kept for future reference.

**Follow Warnings** • Follow all warnings and instructions marked on the equipment or in the user information.

**Avoid Attachments** • Do not use tools or attachments that are not recommended by the equipment manufacturer because they may be hazardous.

## Consignes de Sécurité • Français



Ce symbole sert à avertir l'utilisateur que la documentation fournie avec le matériel contient des instructions importantes concernant l'exploitation et la maintenance (réparation).



Ce symbole sert à avertir l'utilisateur de la présence dans le boîtier de l'appareil de tensions dangereuses non isolées posant des risques d'électrocution.

### Attention

**Lire les instructions** • Prendre connaissance de toutes les consignes de sécurité et d'exploitation avant d'utiliser le matériel.

**Conservier les instructions** • Ranger les consignes de sécurité afin de pouvoir les consulter à l'avenir.

**Respecter les avertissements** • Observer tous les avertissements et consignes marqués sur le matériel ou présentés dans la documentation utilisateur.

**Eviter les pièces de fixation** • Ne pas utiliser de pièces de fixation ni d'outils non recommandés par le fabricant du matériel car cela risquerait de poser certains dangers.

## Sicherheitsanleitungen • Deutsch



Dieses Symbol soll dem Benutzer in der im Lieferumfang enthaltenen Dokumentation besonders wichtige Hinweise zur Bedienung und Wartung (Instandhaltung) geben.



Dieses Symbol soll den Benutzer darauf aufmerksam machen, daß im Inneren des Gehäuses dieses Produktes gefährliche Spannungen, die nicht isoliert sind und die einen elektrischen Schock verursachen können, herrschen.

### Achtung

**Lesen der Anleitungen** • Bevor Sie das Gerät zum ersten Mal verwenden, sollten Sie alle Sicherheits- und Bedienungsanleitungen genau durchlesen und verstehen.

**Aufbewahren der Anleitungen** • Die Hinweise zur elektrischen Sicherheit des Produktes sollten Sie aufbewahren, damit Sie im Bedarfsfall darauf zurückgreifen können.

**Befolgen der Warnhinweise** • Befolgen Sie alle Warnhinweise und Anleitungen auf dem Gerät oder in der Benutzerdokumentation.

**Keine Zusatzgeräte** • Verwenden Sie keine Werkzeuge oder Zusatzgeräte, die nicht ausdrücklich vom Hersteller empfohlen wurden, da diese eine Gefahrenquelle darstellen können.

## Instrucciones de seguridad • Español



Este símbolo se utiliza para advertir al usuario sobre instrucciones importantes de operación y mantenimiento (o cambio de partes) que se desean destacar en el contenido de la documentación suministrada con los equipos.



Este símbolo se utiliza para advertir al usuario sobre la presencia de elementos con voltaje peligroso sin protección aislante, que puedan encontrarse dentro de la caja o alojamiento del producto, y que puedan representar riesgo de electrocución.

### Precaucion

**Leer las instrucciones** • Leer y analizar todas las instrucciones de operación y seguridad, antes de usar el equipo.

**Conservar las instrucciones** • Conservar las instrucciones de seguridad para futura consulta.

**Obedecer las advertencias** • Todas las advertencias e instrucciones marcadas en el equipo o en la documentación del usuario, deben ser obedecidas.

**Evitar el uso de accesorios** • No usar herramientas o accesorios que no sean específicamente recomendados por el fabricante, ya que podrían implicar riesgos.

## 安全须知 • 中文



这个符号提示用户该设备用户手册中有重要的操作和维护说明。



这个符号警告用户该设备机壳内有暴露的危险电压，有触电危险。

### 注意

**阅读说明书** • 用户使用该设备前必须阅读并理解所有安全和使用说明。

**保存说明书** • 用户应保存安全说明书以备将来使用。

**遵守警告** • 用户应遵守产品和用户指南上的所有安全和操作说明。

**避免追加** • 不要使用该产品厂商没有推荐的工具或追加设备，以避免危险。

## Warning

**Power sources** • This equipment should be operated only from the power source indicated on the product. This equipment is intended to be used with a main power system with a grounded (neutral) conductor. The third (grounding) pin is a safety feature, do not attempt to bypass or disable it.

**Power disconnection** • To remove power from the equipment safely, remove all power cords from the rear of the equipment, or the desktop power module (if detachable), or from the power source receptacle (wall plug).

**Power cord protection** • Power cords should be routed so that they are not likely to be stepped on or pinched by items placed upon or against them.

**Servicing** • Refer all servicing to qualified service personnel. There are no user-serviceable parts inside. To prevent the risk of shock, do not attempt to service this equipment yourself because opening or removing covers may expose you to dangerous voltage or other hazards.

**Slots and openings** • If the equipment has slots or holes in the enclosure, these are provided to prevent overheating of sensitive components inside. These openings must never be blocked by other objects.

**Lithium battery** • There is a danger of explosion if battery is incorrectly replaced. Replace it only with the same or equivalent type recommended by the manufacturer. Dispose of used batteries according to the manufacturer's instructions.

## Avertissement

**Alimentations** • Ne faire fonctionner ce matériel qu'avec la source d'alimentation indiquée sur l'appareil. Ce matériel doit être utilisé avec une alimentation principale comportant un fil de terre (neutre). Le troisième contact (de mise à la terre) constitue un dispositif de sécurité : n'essayez pas de la contourner ni de la désactiver.

**Déconnexion de l'alimentation** • Pour mettre le matériel hors tension sans danger, déconnectez tous les cordons d'alimentation de l'arrière de l'appareil ou du module d'alimentation de bureau (s'il est amovible) ou encore de la prise secteur.

**Protection du cordon d'alimentation** • Acheminer les cordons d'alimentation de manière à ce que personne ne risque de marcher dessus et à ce qu'ils ne soient pas écrasés ou pincés par des objets.

**Réparation-maintenance** • Faire exécuter toutes les interventions de réparation-maintenance par un technicien qualifié. Aucun des éléments internes ne peut être réparé par l'utilisateur. Afin d'éviter tout danger d'électrocution, l'utilisateur ne doit pas essayer de procéder lui-même à ces opérations car l'ouverture ou le retrait des couvercles risquent de l'exposer à de hautes tensions et autres dangers.

**Fentes et orifices** • Si le boîtier de l'appareil comporte des fentes ou des orifices, ceux-ci servent à empêcher les composants internes sensibles de surchauffer. Ces ouvertures ne doivent jamais être bloquées par des objets.

**Lithium Batterie** • Il y a danger d'explosion s'il y a un remplacement incorrect de la batterie. Remplacer uniquement avec une batterie du même type ou d'un type équivalent recommandé par le constructeur. Mettre au rebut les batteries usagées conformément aux instructions du fabricant.

## Vorsicht

**Stromquellen** • Dieses Gerät sollte nur über die auf dem Produkt angegebene Stromquelle betrieben werden. Dieses Gerät wurde für eine Verwendung mit einer Hauptstromleitung mit einem geerdeten (neutralen) Leiter konzipiert. Der dritte Kontakt ist für einen Erdschluß, und stellt eine Sicherheitsfunktion dar. Diese sollte nicht umgangen oder außer Betrieb gesetzt werden.

**Stromunterbrechung** • Um das Gerät auf sichere Weise vom Netz zu trennen, sollten Sie alle Netzkabel aus der Rückseite des Gerätes, aus der externen Stromversorgung (falls dies möglich ist) oder aus der Wandsteckdose ziehen.

**Schutz des Netzkabels** • Netzkabel sollten stets so verlegt werden, daß sie nicht im Weg liegen und niemand darauf treten kann oder Objekte darauf- oder unmittelbar dagegengestellt werden können.

**Wartung** • Alle Wartungsmaßnahmen sollten nur von qualifiziertem Servicepersonal durchgeführt werden. Die internen Komponenten des Gerätes sind wartungsfrei. Zur Vermeidung eines elektrischen Schocks versuchen Sie in keinem Fall, dieses Gerät selbst öffnen, da beim Entfernen der Abdeckungen die Gefahr eines elektrischen Schlags und/oder andere Gefahren bestehen.

**Schlitze und Öffnungen** • Wenn das Gerät Schlitze oder Löcher im Gehäuse aufweist, dienen diese zur Vermeidung einer Überhitzung der empfindlichen Teile im Inneren. Diese Öffnungen dürfen niemals von anderen Objekten blockiert werden.

**Lithium-Batterie** • Explosionsgefahr, falls die Batterie nicht richtig ersetzt wird. Ersetzen Sie verbrauchte Batterien nur durch den gleichen oder einen vergleichbaren Batterietyp, der auch vom Hersteller empfohlen wird. Entsorgen Sie verbrauchte Batterien bitte gemäß den Herstelleranweisungen.

## Advertencia

**Alimentación eléctrica** • Este equipo debe conectarse únicamente a la fuente/tipo de alimentación eléctrica indicada en el mismo. La alimentación eléctrica de este equipo debe provenir de un sistema de distribución general con conductor neutro a tierra. La tercera pata (puesta a tierra) es una medida de seguridad, no puentearla ni eliminarla.

**Desconexión de alimentación eléctrica** • Para desconectar con seguridad la acometida de alimentación eléctrica al equipo, desenchufar todos los cables de alimentación en el panel trasero del equipo, o desenchufar el módulo de alimentación (si fuera independiente), o desenchufar el cable del receptáculo de la pared.

**Protección del cables de alimentación** • Los cables de alimentación eléctrica se deben instalar en lugares donde no sean pisados ni apretados por objetos que se puedan apoyar sobre ellos.

**Reparación/mantenimiento** • Solicitar siempre los servicios técnicos de personal calificado. En el interior no hay partes a las que el usuario deba acceder. Para evitar riesgo de electrocución, no intentar personalmente la reparación/mantenimiento de este equipo, ya que al abrir o extraer las tapas puede quedar expuesto a voltajes peligrosos u otros riesgos.

**Ranuras y aberturas** • Si el equipo posee ranuras o orificios en su caja/alojamiento, es para evitar el sobrecalentamiento de componentes internos sensibles. Estas aberturas nunca se deben obstruir con otros objetos.

**Batería de litio** • Existe riesgo de explosión si esta batería se coloca en la posición incorrecta. Cambiar esta batería únicamente con el mismo tipo (o su equivalente) recomendado por el fabricante. Desachar las baterías usadas siguiendo las instrucciones del fabricante.

## 警告

**电源** • 该设备只能使用产品上标明的电源。设备必须使用有地线的供电系统供电。第三条线（地线）是安全设施，不能不用或跳过。

**拔掉电源** • 为安全地从设备拔掉电源，请拔掉所有设备后或桌面电源的电源线，或任何接到市电系统的电源线。

**电源线保护** • 妥善布线，避免被踩踏，或重物挤压。

**维护** • 所有维修必须由认证的维修人员进行。设备内部没有用户可以更换的零件。为避免出现触电危险不要自己试图打开设备盖子维修该设备。

**通风孔** • 有些设备机壳上有通风槽或孔，它们是用来防止机内敏感元件过热。不要用任何东西挡住通风孔。

**锂电池** • 不正确的更换电池会有爆炸的危险。必须使用与厂家推荐的相同或相近型号的电池。按照生产的建议处理废弃电池。

## FCC Class A Notice

This equipment has been tested and found to comply with the limits for a Class A digital device, pursuant to part 15 of the FCC Rules. Operation is subject to the following two conditions:

1. This device may not cause harmful interference.
2. This device must accept any interference received, including interference that may cause undesired operation.

The Class A limits are designed to provide reasonable protection against harmful interference when the equipment is operated in a commercial environment. This equipment generates, uses, and can radiate radio frequency energy and, if not installed and used in accordance with the instruction guide, may cause harmful interference to radio communications. Operation of this equipment in a residential area is likely to cause harmful interference, in which case the user will be required to correct the interference at his own expense.

**NOTE:** This unit was tested with shielded cables on the peripheral devices. Shielded cables must be used with the unit to ensure compliance with FCC emissions limits.  
For more information on safety guidelines, regulatory compliances, EMI/EMF compliance, accessibility, and related topics, [click here](#).

## Conventions Used in this Guide

In this user guide, the following are used:

**CAUTION:** A caution indicates a potential hazard to equipment or data.

**NOTE:** A note draws attention to important information.

**TIP:** A tip provides a suggestion to make working with the application easier.

**WARNING:** A warning warns of things or actions that might cause injury, death, or other severe consequences.

### Copyright

© 2011 Extron Electronics. All rights reserved.

### Trademarks

All trademarks mentioned in this guide are the properties of their respective owners.

# Contents

---

|  |          |
|--|----------|
| <b>Introduction .....</b>                                      | <b>1</b> |
| About this Guide .....   | 1        |
| About the DTP HDMI 301 Tx/Rx Transmitter<br>and Receiver ..... | 1        |
| TP Cable Advantages .....                                      | 2        |
| Control Communications .....                                   | 2        |
| Features.....  | 2        |

---

|  |          |
|--|----------|
| <b>Installation and Operation.....</b>     | <b>3</b> |
| Mounting the Transmitter or Receiver ..... | 3        |
| Connections .....                          | 3        |
| Transmitter Connections .....              | 3        |
| Receiver Connections .....                 | 5        |
| Pin Assignments and Wiring.....            | 7        |
| Operation .....                            | 11       |

---

|  |           |
|--|-----------|
| <b>Reference Information .....</b>           | <b>12</b> |
| Specifications.....                          | 12        |
| Part Numbers and Accessories.....            | 15        |
| Transmitter/receiver Pair Part Numbers ..... | 15        |
| Included Parts .....                         | 15        |
| Cables and Adapters.....                     | 15        |
| Mounting Accessories .....                   | 16        |
| Mounting the Transmitter or Receiver .....   | 16        |
| Tabletop Use .....                           | 16        |
| Mounting kits .....                          | 16        |
| UL Rack-Mounting Guidelines .....            | 16        |



# Introduction

- [About this Guide](#)
- [About the DTP HDMI 301 Transmitter and Receiver](#)
- [Features](#)

## About this Guide

This guide describes the Extron DTP HDMI 301 High Definition Multimedia Interface (HDMI™) Extender, which consists of a DTP HDMI 301 Tx transmitter and a DTP HDMI 301 Rx receiver. This guide describes how to install, operate, and configure the transmitter and receiver.

## About the DTP HDMI 301 Tx/Rx Transmitter and Receiver

The Extron DTP HDMI 301 Tx/Rx transmitter and receiver pair (see figure 1) extends the usable distance of HDCP-compliant HDMI digital video (with embedded audio), optional analog audio, and bidirectional RS-232 and infrared (IR) control signals over one or two pair Category (CAT) 5e, CAT 6, and CAT 6a unshielded twisted pair (UTP) or shielded twisted pair (STP) cables. The DTP HDMI 301 can also extend DVI video with applicable adapters. The video, audio, and control signals can be transmitted up to 330 feet (100 m).

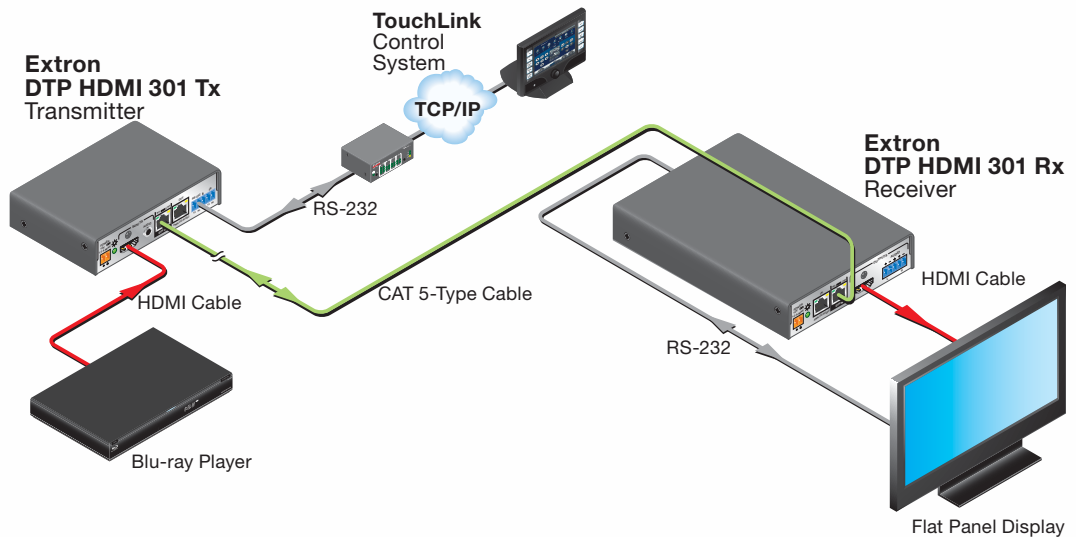

**Figure 1.** Typical Transmitter and Receiver Application

The pair requires only one cable to transmit HDMI digital video, embedded audio, and the RS-232 and IR link. The pair requires a second cable to extend analog audio.

The DTP HDMI 301 Tx/Rx units are housed in quarter rack width metal enclosures. They can be set on a tabletop or mounted in a rack, under or through furniture, or to a projector pole.

The transmitter is shipped with a single external desktop 12 VDC power supply that accepts 100 to 240 VAC, 50-60 Hz input. A single power supply connected to either the transmitter or the receiver can power both units through the TP cable that carries HDMI video.

## TP Cable Advantages

Twisted pair cable is much smaller, lighter, more flexible, and less expensive than coaxial or HDMI cable. These transmitter and receiver twisted pair (TP) products make cable runs simpler and less cumbersome. Termination of the cable with RJ-45 connectors is simple, quick, and economical.

**NOTE:** Do **not** use Extron UTP23SF-4 Enhanced Skew-Free™ AV UTP cable or STP201 cable to link the transmitter and receiver. The DTP HDMI 301 Tx/Rx does not work properly with these cables.

## Control Communications

The RS-232 and IR communications are via a passive pass-through only; the transmitter and receiver do not generate or respond to these signals.

## Features

**Transmits single link HDMI signals over a single CAT 5e, CAT 6, or CAT 6a cable** — Standard twisted pair cables provide an economical, easily installed cable solution.

**Transmits analog audio signals over a separate, optional CAT 5e or CAT 6 cable** — Standard twisted pair cables provide an economical, easily installed cable solution.

**Long distance transmission** — Up to 330 feet (100 m)

**Supports Display Data Channel (DDC) and HDCP copy protection transmission** — The transmitter and receiver pair fully supports long distance transmission of the DDC and HDCP signals.

**Control communications pass-through** — Bidirectional RS-232 and IR control signals can be transmitted alongside the HDMI signal, so that the remote display can be controlled without the need for additional cabling.

**Supports CEC signal transmission**

**1-inch high, quarter rack width, metal enclosures** — With low profile enclosures, the transmitter and receiver can be discreetly installed in locations such as behind a plasma or LCD flat-panel display.

**External 100 VAC to 240 VAC, 50-60 Hz, international power supply (part number 70-775-01)** — Included with the transmitter

**Remote powering of transmitter or receiver** — Only one power supply is necessary to power both devices.



# Installation and Operation

This section describes the installation and the operation of the DTP HDMI 301 Tx/Rx Extender, including:

- **Mounting the Transmitter or Receiver**
- **Connections**
- **Operation**

## Mounting the Transmitter or Receiver

**CAUTION:** Installation and service must be performed by authorized personnel only.

Mounting instructions and the applicable optional hardware can be found in the “**Reference Information**” section. The 1-inch high, quarter rack width DTP HDMI 301 transmitter or receiver can be placed on a tabletop, mounted on a rack shelf, or mounted under a desk or tabletop. The receiver can also be mounted on a projector bracket.

## Connections

### Transmitter Connections

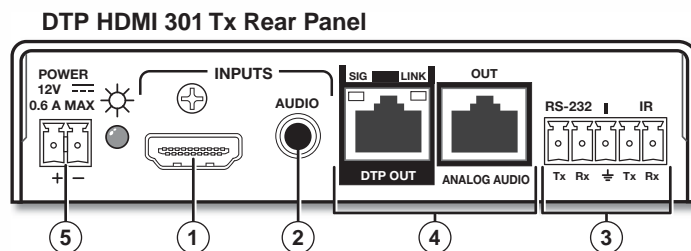

**Figure 2.** DTP HDMI 301 Tx Rear Panel Connectors

- ① **Input connector** — Connect an HDMI cable between this port and the HDMI output port of the digital video source.

**NOTE:** See “**HDMI connector**” for pin assignments and to use the LockIt® HDMI Cable Lacing Bracket to secure the connector to the transmitter.

- ② **Audio connector** — If desired, plug an analog audio input into the transmitter via this stereo mini jack connector.

**NOTES:**

- The analog audio input on this connector is in addition to the digital audio that is embedded in the HDMI input.

- See the figure at right to identify the tip, ring, and sleeve when you are making connections for the transmitter from existing audio cables. A mono audio connector consists of the tip and sleeve. A stereo audio connector consists of the tip, ring, and sleeve.

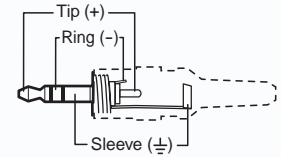

**3.5 mm Stereo Plug Connector (balanced)**

- ③ **RS-232 and IR connector** — Connect a serial RS-232 signal, a modulated IR signal, or both to this 3.5 mm, 5-pole captive screw connector for bidirectional RS-232 and IR communication. See “[RS-232 and IR connector wiring](#)” to wire the connector.
- ④ **DTP and Analog Audio Output RJ-45 connectors** — Connect one end of one (or two) TP cables to these RJ-45 female connectors on the transmitter.

**CAUTION:** Do not connect this device to a computer data or telecommunications network.

**NOTE:** See “[TP cable termination](#)” to properly wire the RJ-45 connectors and for detailed **NOTES**.

- ④a **DTP Output connector (Required)** — Ensure the free end of this cable is connected to the receiver DTP In connector ([item 6a](#)). This cable carries:

- TMDS (digital) video
- Embedded audio
- Bidirectional RS-232 and IR commands and data
- Remote power

**Signal LED** — This LED lights when the unit is receiving a TMDS clock signal on the HDMI input (transmitter) or any valid signal on the DTP In connector (receiver).

**Link LED** — This LED lights when a valid link is established between the units on the DTP input and output cable.

- ④b **Analog Audio Output connector (Optional)** — If desired, ensure the free end of this cable is connected to the receiver Analog Audio In connector ([item 6b](#)). This cable carries analog audio **only** and is not needed for applications that do not require this audio signal.

- ⑤ **Power input connector** — Plug the included external 12 VDC power supply into either this 2-pole connector **or** the power input connector on the receiver ([item 10](#)). See “[Power supply wiring](#)” to wire the connector.

**NOTE:** One power supply can power both units. A power supply is included with the transmitter.

## Receiver Connections

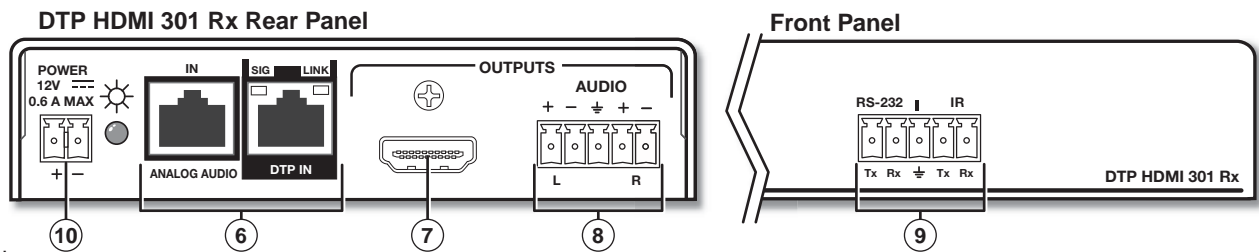

**Figure 3.** DTP HDMI 301 Rx Rear Panel Connectors

- ⑥ **DTP and Analog Audio Input RJ-45 connectors** — Connect one end of the one or two separate TP cables from the transmitter output connectors to these RJ-45 female connectors.

**CAUTION:** Do not connect this device to a computer data or telecommunications network.

**NOTE:** See “**TP cable termination**” to properly wire the RJ-45 connectors and for detailed **NOTES**.

- ⑥a **DTP Input connector (Required)** — Ensure the free end of this cable is connected to the transmitter DTP Out connector (item 4a). This cable carries:
- TMDS (digital) video
  - Embedded audio
  - Bidirectional RS-232 and IR commands and data
  - Remote power
- Signal LED** — This LED lights when the unit is receiving a TMDS clock signal on the DVI input (transmitter) or any valid signal on the DTP In connector (receiver).
- Link LED** — This LED lights when a valid link is established between the units on the DTP input and output cable.
- ⑥b **Analog Audio Input connector (Optional)** — If desired, ensure the free end of this cable is connected to the transmitter Analog Audio Out connector (item 4b). This cable carries analog audio **only** and is not needed for applications that do not require this audio signal.
- ⑦ **Output connector** — Connect a display with an HDMI input to display the transmitted direct digital image.

**NOTE:** See “**HDMI connector**” for pin assignments and to use the LockIt HDMI Cable Lacing Bracket to secure the connector to the receiver.

- ⑧ **Audio output connector** — This 5-pole, 3.5 mm captive screw connector outputs the transmitted, unamplified, line level analog audio. Connect an audio device, such as an audio amplifier or powered speakers.

See figure 4 to properly wire a captive screw output connector. Use the supplied tie-wrap to strap the audio cable to the extended tail of the connector.

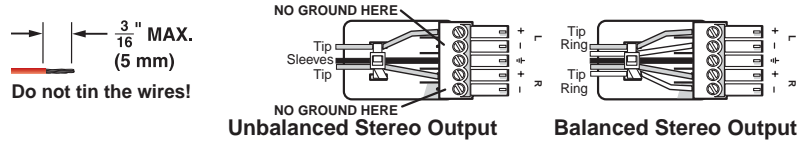

**Figure 4.** Captive Screw Connector Wiring for Stereo Audio Output

**CAUTION:** For unbalanced audio, connect the sleeves to the ground contact. **DO NOT** connect the sleeves to the negative (-) contacts.

**NOTE:** The length of exposed wires is critical. The ideal length is 3/16 inch (5 mm).

- If the stripped section of wire is longer than 3/16 inch, the exposed wires may touch, causing a short circuit.
- If the stripped section of wire is shorter than 3/16 inch, wires can be easily pulled out even if tightly fastened by the captive screws.

- ⑨ **RS-232 and IR connector** — Connect a serial RS-232 signal, a modulated IR signal, or both to this 3.5 mm, 5-pole captive screw connector for bidirectional RS-232 and IR communication. See “[RS-232 and IR connector wiring](#)” to wire the connector.
- ⑩ **Power input connector** — Plug the included external 12 VDC power supply into either this 2-pole connector **or** the power input connector on the transmitter (item ⑤). See “[Power supply wiring](#)” to wire the connector.

**NOTE:** One power supply can power both units. A power supply is included with the transmitter.

## Pin Assignments and Wiring

### HDMI connector

Figure 5 defines the pinout for the HDMI connector.

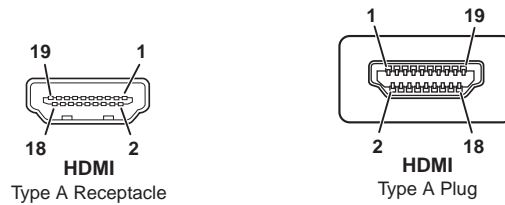

| Pin | Signal             | Pin | Signal             | Pin | Signal           |
|-----|--------------------|-----|--------------------|-----|------------------|
| 1   | TMDS data 2+       | 7   | TMDS data 0-       | 13  | CEC control      |
| 2   | TMDS data 2 shield | 8   | TMDS data 0 shield | 14  | Reserved (NC)    |
| 3   | TMDS data 2-       | 9   | TMDS data 0-       | 15  | SCL              |
| 4   | TMDS data 1+       | 10  | TMDS clock+        | 16  | SDA              |
| 5   | TMDS data 1 shield | 11  | TMDS clock shield  | 17  | DDC / CEC Ground |
| 6   | TMDS data 1-       | 12  | TMDS clock-        | 18  | +5 V power       |
|     |                    |     |                    | 19  | Hot plug detect  |

**Figure 5. HDMI Connector**

To securely fasten an HDMI cable to a device:

1. Plug the HDMI cable into the panel connection (see figure 6).

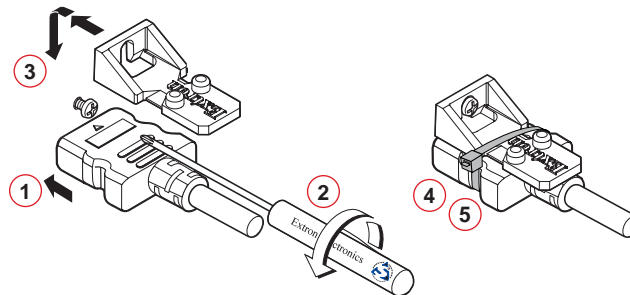

**Figure 6. Installing the LockIt Lacing Bracket**

2. Loosen the HDMI connection mounting screw from the panel enough to allow the LockIt lacing bracket to be placed over it. The screw does not have to be removed.
3. Place the LockIt lacing bracket on the screw and against the HDMI connector, then tighten the screw to secure the bracket.

**CAUTION:** Do not overtighten the HDMI connector mounting screw. The shield it fastens to is very thin and can easily be stripped.

4. Loosely place the included tie wrap around the HDMI connector and the LockIt lacing bracket as shown.
5. While holding the connector securely against the lacing bracket, use pliers or similar tools to tighten the tie wrap, then remove any excess length.

## TP cable termination

Figure 7 details the recommended termination of TP cables with RJ-45 connectors in accordance with either the **TIA/EIA T 568A** or the **TIA/EIA T 568B** wiring standard.

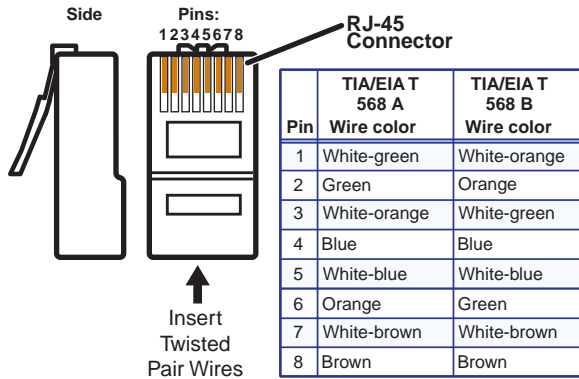

**Figure 7.** TP Cable Termination

- NOTES:**
- RJ-45 termination with CAT 5e, CAT 6, or CAT 6a cable must comply with the TIA/EIA T 568A or TIA/EIA T 568B wiring standard for all connections.
  - Terminate both ends of both cables identically, in accordance with either TIA/EIA T 568A or TIA/EIA T 568B.
  - Do **not** use Extron UTP23SF-4 Enhanced Skew-Free™ AV UTP cable or STP201 cable to link the transmitter and receiver. The DTP DVI 301 Tx/Rx does not work properly with these cables.
  - Only one cable, DTP, is necessary. The Analog Audio cable carries an additional audio signal that is not required for system operation.
  - Connect transmitter DTP Out to receiver DTP In.  
Connect transmitter Analog Audio Out to receiver Analog Audio In.
  - If necessary, check the DTP Out to DTP In cable connection as follows:
    1. Plug a cable into the DTP port on the **powered** unit.
    2. Connect the opposite end of the cable into the DTP port on the **unpowered** unit.

If the DTP Link LED and the Power LED on the unpowered unit are lit, the connection is correct.

## Terminating shielded cable

The Tx and Rx each include two shielded RJ-45 connectors and a length of self-adhesive shielded tape that you can use to make the STP cables that connect the transmitter and receiver.

**NOTE:** Extron supplies the connectors and the shielded tape. You must supply the CAT 5e, CAT 6, or CAT 6a STP cable.

Terminate the STP cable as follows:

1. Peel back the cable shielding (see figure 8) from the end of the cable the length of the RJ-45 connector body (approximately 7/8 inch [2.2 cm]) and fold it back.

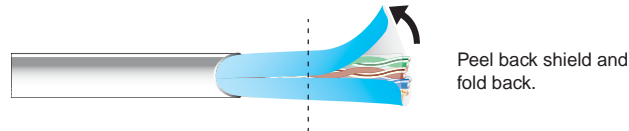

**Figure 8. Peeling Back the Cable Shielding**

2. Cut away and discard the clear cellophane inner wrapper from the end of the cable back to the folded-over cable shielding.
3. Peel the backing off the self-adhesive shielded aluminum tape and wrap it around the folded-over cable shielding, **slightly overlapping** the beginning of the tape (see figure 9).

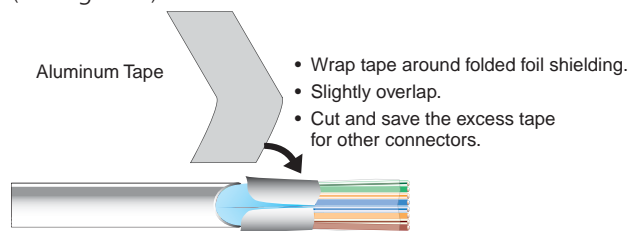

**Figure 9. Wrapping the Shielded Tape**

4. Cut the unused portion of the shielded tape and retain for shielding other RJ-45 connectors.
5. Feed each individual wire into the appropriate slot of the RJ-45 connector and crimp the cable in the normal manner, folding the tangs at the end of the connector over the shielded tape (see figure 10).

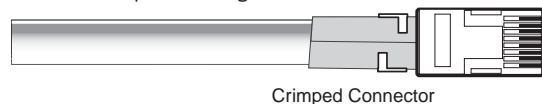
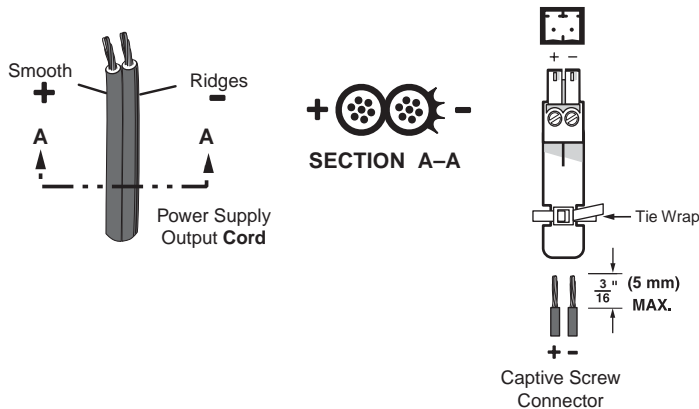

**Figure 10. Crimped RJ-45 Connector**

## Power supply wiring

- NOTES:**
- Only one power supply is required. A single power supply connected to either unit in the pair powers both units.
  - A power supply is included with each transmitter.

Figure 11 shows how to wire the connector. Use the supplied tie-wrap to strap the power cord to the extended tail of the connector.



**Figure 11. Power Connector Wiring**

- CAUTIONS:**
- This product is intended to be supplied by a Listed Power Unit marked "Class 2" or "LPS," rated 12 VDC, 1.0 A minimum. Always use a power supply supplied by or specified by Extron. Use of an unauthorized power supply voids all regulatory compliance certification and may cause damage to the supply and the end product.
  - Unless otherwise stated, the AC/DC adapters are not suitable for use in air handling spaces or in wall cavities.
  - The installation must always be in accordance with the applicable provisions of National Electrical Code ANSI/NFPA 70, article 75 and the Canadian Electrical Code part 1, section 16. The power supply shall not be permanently fixed to a building structure or similar structure.
  - Power supply voltage polarity is critical. Incorrect voltage polarity can damage the power supply and the unit. The ridges on the side of the cord (see figure 11) identify the power cord negative lead.

To verify the polarity before connection, plug in the power supply with no load and check the output with a voltmeter.

**WARNING:** The two power cord wires must be kept separate while the power supply is plugged in. Remove power before wiring.

**CAUTION:** The length of the exposed (stripped) copper wires is important. The ideal length is 3/16 inch (5 mm). See the **NOTE** on page 6 for details.

**NOTE:** Do not tin the power supply leads before installing them in the connector. Tinned wires are not as secure in the connector and could be pulled out.



## RS-232 and IR connector wiring

Figure 12 shows how to wire the RS-232 connector.

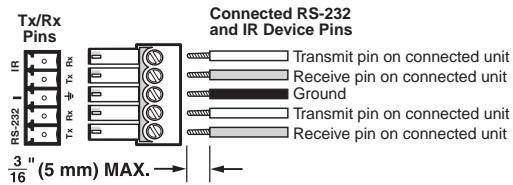
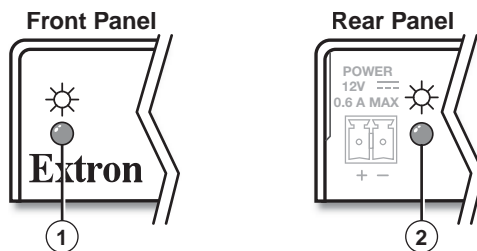

**Figure 12.** RS-232 Connector Wiring

**NOTE:** The length of exposed wires is important. The ideal length is  $\frac{3}{16}$  inch (5 mm). See the **NOTE** on page 6 for details. Do not tin the power supply leads before installing them in the connector. Tinned wires are not as secure in the connector and could be pulled out.

## Operation

Figure 13 shows the location of the power indicators on the front and rear panels of the transmitter and receiver.



**Figure 13.** Power Indicators

① **Power (and signal) LED (front panel)** —

**Amber** — The unit is receiving power, either locally or remotely (on the DTP cable).

**Green** — The unit is receiving an active HDMI signal, either on the HDMI input if a transmitter, or transmitted on the DTP cable if a receiver.

② **Power LED (rear panel)** —

**Amber** — The unit is receiving power remotely (on the DTP cable).

**Green** — The unit is receiving power locally.

After the transmitter, the receiver, and their connected devices are powered up, the system is fully operational. If any problems are encountered, ensure all cables are routed and connected properly.

**NOTE:** Ensure that the video source and display selected for the DDC are properly connected to the transmitter and receiver pair, and that the transmitter, the receiver, and the display have power applied **before** power is applied to the video source. If the other devices are not turned on before the video source, the image may not appear.

# Reference Information

This section discusses the specifications, part numbers, and accessories for the DTP HDMI 301 Tx/Rx transmitter and receiver. Topics that are covered include:

- **Specifications**
- **Part Numbers and Accessories**
- **Mounting the Transmitter or Receiver**

## Specifications

**NOTES:** • This product consists of a transmitter (DTP HDMI 301 Tx) and a receiver (DTP HDMI 301 Rx), sold separately, with twisted pair cables linking the transmitter and receiver.  
• \*Appropriate HDMI to DVI-DI cables or adapters are required for DVI signal input/output.

### Video

|                          |  |
|--------------------------|--|
| Maximum data rate.....   | 6.75 Gbps (2.25 Gbps per color)                                |
| Maximum pixel clock..... | 165 MHz  |
| Resolution range .....   | Up to 1920x1200 or 1080p @ 60 Hz; 8, 10, or 12 bit color depth |
| Formats.....             | RGB and YCbCr digital video                                    |
| Standards.....           | DVI 1.0, HDMI 1.3  |

### Video input — transmitter

|                          |                                |
|--------------------------|--------------------------------|
| Number/signal type ..... | 1 single link HDMI (or DVI-D*) |
| Connectors .....         | 1 female HDMI type A           |

### Interconnection between transmitter and receiver

|                                    |  |
|------------------------------------|--|
| Connectors .....                   | 2 female RJ-45 per unit for 2 cables connecting the transmitter and receiver<br>TP1 output transmits digital video, embedded digital audio, RS-232, IR, and remote power.<br>TP2 output transmits analog stereo audio. |
| Termination standards .....        | TIA/EIA T568A or T568B   |
| Signal transmission distance ..... | 330' (100 m) using CAT 5e/6 UTP or STP cable   |

### Video output — receiver

|                          |                                |
|--------------------------|--------------------------------|
| Number/signal type ..... | 1 single link HDMI (or DVI-D*) |
| Connectors .....         | 1 female HDMI type A           |

### Audio

|                                 |   |
|---------------------------------|---|
| Gain.....                       | Unbalanced output: 0 dB; balanced output +6 dB            |
| Frequency response.....         | 20 Hz to 20 kHz, $\pm 0.05$ dB                            |
| THD + Noise.....                | 0.03% @ 20 Hz to 20 kHz at maximum output                 |
| S/N.....                        | >90 dB, at maximum output (15 dBu), balanced (unweighted) |
| Stereo channel separation ..... | >80 dB @ 1 kHz to 20 kHz                                  |

## Audio input

|                          |   |
|--------------------------|---|
| Number/signal type ..... | 1 PC level stereo, unbalanced   |
| Connectors .....         | (1) 3.5 mm stereo jack, 2 channel; tip (L), ring (R), sleeve (ground) |
| Impedance .....          | >10k ohms, DC coupled   |
| Nominal level .....      | -10 dBV (316 mVrms)   |
| Maximum level.....       | +7 dBV (unbalanced)   |

**NOTE:** 0 dBu = 0.775 Vrms, 0 dBV = 1 Vrms, 0 dBV  $\approx$  2 dBu

## Audio output

|                              |  |
|------------------------------|--|
| Number/signal type .....     | 1 stereo (2 channel), balanced/unbalanced  |
| Connectors .....             | (1) 3.5 mm captive screw connector, 5 pole |
| Impedance .....              | 50 ohms unbalanced, 100 ohms balanced      |
| Gain error .....             | $\pm$ 0.1 dB channel to channel            |
| Maximum level (600 ohm)..... | >+15 dBu, balanced                         |

## Control/remote — external device (pass-through, unidirectional or bidirectional)

### Serial control port input/output

|                   |   |
|-------------------|---|
| Transmitter ..... | RS-232 via (1) 3.5 mm, 5 pole captive screw connector for RS-232 control ( $\pm$ 5 V)<br>(connector is shared with IR control port) |
| Receiver .....    | 1 set of proprietary signals on a female RJ-45 jack   |

### Serial control port output/input

|                   |   |
|-------------------|---|
| Transmitter ..... | 1 set of proprietary signals on a female RJ-45 jack |
| Receiver .....    | RS-232 via a 3.5 mm, 3 pole captive screw connector |

Baud rates..... Up to 115200 baud

Protocol .....

- Data bits = 5 - 8
- Stop bits = 1 or 2
- Parity = odd, even, none
- Flow control = XON, XOFF, none

Serial control pin configuration..... 1 = Tx, 2 = Rx, 3 = GND

IR control port .....

- (1) 3.5 mm, captive screw connector, 5 pole (connector is shared with RS-232 control port)
- TTL level (0 to 5 V) modulated infrared control from 30 kHz up to 60 kHz

IR control pin configuration..... 3 = GND, 4 = IR Tx, 5 = IR Rx

## General

|                         |   |
|-------------------------|---|
| Power supply.....       | External<br>Input: 100-240 VAC, 50-60 Hz<br>Output: 12 VDC, 1 A, 12 watts |
| Power consumption ..... | 7.0 watts, 12 VDC, total, for both transmitter and receiver               |

**NOTE:** Each transmitter or receiver can be powered either locally by an external power supply or remotely by receiver or transmitter on the other end of the CAT 5/5e/6 cable.

|                            |  |
|----------------------------|--|
| Temperature/humidity ..... | Storage: -40 to +158 °F (-40 to +70 °C) / 10% to 90%, noncondensing<br>Operating: +32 to +122 °F (0 to +50 °C) / 10% to 90%, noncondensing |
|----------------------------|--|

|               |                      |
|---------------|----------------------|
| Cooling ..... | Convection, no vents |
|---------------|----------------------|

### Mounting

|                       |  |
|-----------------------|--|
| Rack mount .....      | Yes, with optional 1U high rack shelf      |
| Furniture mount ..... | Yes, with optional under-desk mounting kit |

|                      |       |
|----------------------|-------|
| Enclosure type ..... | Metal |
|----------------------|-------|

### Enclosure dimensions

|                   |  |
|-------------------|--|
| Transmitter ..... | 1.0" H x 4.3" W x 3.0" D (quarter rack wide)<br>(2.5 cm H x 10.9 cm W x 7.6 cm D)<br>(Depth excludes connectors.)  |
| Receiver .....    | 1.0" H x 4.3" W x 6.0" D (quarter rack wide)<br>(2.5 cm H x 10.9 cm W x 15.2 cm D)<br>(Depth excludes connectors.) |

### Product weight

|                   |                  |
|-------------------|------------------|
| Transmitter ..... | 0.5 lbs (0.3 kg) |
| Receiver .....    | 1.0 lb (0.5 kg)  |

|                      |              |
|----------------------|--------------|
| Shipping weight..... | 3 lbs (2 kg) |
|----------------------|--------------|

|                 |  |
|-----------------|--|
| Vibration ..... | ISTA 1A in carton (International Safe Transit Association) |
|-----------------|--|

### Regulatory compliance

|               |   |
|---------------|---|
| Safety .....  | CE, c-UL, UL                            |
| EMI/EMC ..... | CE**, C-tick, FCC Class A**, ICES, VCCI |

**NOTE:** \*\*CE and FCC testing is conducted with STP (shielded twisted pair) cable.

|            |              |
|------------|--------------|
| MTBF ..... | 30,000 hours |
|------------|--------------|

|               |                         |
|---------------|-------------------------|
| Warranty..... | 3 years parts and labor |
|---------------|-------------------------|

**NOTES:**

- All nominal levels are at  $\pm 10\%$ .
- Specifications are subject to change without notice.

## Part Numbers and Accessories

### Transmitter/Receiver Pair Part Numbers

**NOTE:** The Tx/Rx is comprised of the transmitter and receiver pair, which are purchased separately.

| DTP HDMI 301 Model          | Part Number |
|-----------------------------|-------------|
| DTP HDMI 301 Tx transmitter | 60-1212-12  |
| DTP HDMI 301 Rx receiver    | 60-1212-13  |

### Included Parts

These items are included with in each DTP HDMI 301 transmitter and receiver:

| Included parts  | Part Number |
|---|-------------|
| <b>DTP HDMI 301 Tx Transmitter</b>  |             |
| 12 VDC, 1 A external power supply with 3.5 mm, 2-pole captive screw connector | 70-775-01   |
| IEC power cord  |             |
| 3.5 mm, 5-pole captive screw connector (1)                                    |             |
| Shielded RJ-45 connectors (4)   |             |
| Self-adhesive shielded tape   |             |
| LockIt HDMI Lacing Bracket  |             |
| DTP HDMI 301 Setup Guide  |             |
| <b>DTP HDMI 301 Rx Receiver</b>   |             |
| 3.5 mm, 5-pole captive screw connector (2)                                    |             |
| LockIt HDMI Lacing Bracket  |             |
| DTP HDMI 301 Setup Guide  |             |

### Cables and Adapters

| Cable   | Part Number       |
|---|-------------------|
| <b>HDMI M-M Pro/6 Series</b> — HDMI male-to-male cable, various lengths | 26-650- <i>nn</i> |
| <b>HDMI M-DVI-D F</b> — HDMI male to DVI-D female adapter               | 26-617-01         |

## Mounting Accessories

| Mounting kit  | Part Number |
|---|-------------|
| <b>RSF 123</b> 3.5-inch deep 1U rack shelf kit (transmitter only) | 60-190-20   |
| <b>RSB 123</b> 3.5-inch deep 1U rack shelf (transmitter only)     | 60-604-21   |
| <b>RSU 126</b> 6-inch deep 1U universal rack shelf kit            | 60-190-10   |
| <b>RSB 126</b> 6-inch deep 1U basic rack shelf                    | 60-604-11   |
| <b>RSU 129</b> 9.5-inch deep 1U universal rack shelf kit          | 60-190-01   |
| <b>RSB 129</b> 9.5-inch deep 1U basic rack shelf                  | 60-604-02   |
| <b>MBU 125</b> under-desk mount kit                               | 70-077-01   |
| <b>MBD 129</b> through-desk mount kit                             | 70-077-02   |
| <b>PMK 350</b> low profile projector mount kit, white             | 70-563-03   |

## Mounting the Transmitter or Receiver

**CAUTION:** Installation and service must be performed by authorized personnel only.

The 1-inch high, quarter rack width DTP DVI 301 transmitter or receiver can be placed on a table, mounted in a rack, or mounted under a desk or table. The receiver can also be mounted on a projector bracket.

### Tabletop Use

Affix the included rubber feet to the bottom of the unit and place it in any convenient location.

### Mounting kits

Mount the unit using any of the mounting kits listed above, in accordance with the directions included with the kit.

### UL Rack-Mounting Guidelines

The following Underwriters Laboratories (UL) requirements pertain to the installation of the unit into a rack.

- 1. Elevated operating ambient temperature** — If installed in a closed or multi-unit rack assembly, the operating ambient temperature of the rack environment may be greater than room ambient. Therefore, consider installing the equipment in an environment compatible with the maximum ambient temperature (TMA = +122 °F, +50 °C) specified by Extron.
- 2. Reduced air flow** — Installation of the equipment in a rack should be such that the amount of air flow required for safe operation of the equipment is not compromised.
- 3. Mechanical loading** — Mounting of the equipment in the rack should be such that a hazardous condition is not achieved due to uneven mechanical loading.
- 4. Circuit overloading** — Consideration should be given to the connection of the equipment to the supply circuit and the effect that overloading of the circuits might have on overcurrent protection and supply wiring. Appropriate consideration of equipment nameplate ratings should be used when addressing this concern.
- 5. Reliable earthing (grounding)** — Reliable earthing of rack-mounted equipment should be maintained. Particular attention should be given to supply connections other than direct connections to the branch circuit (such as use of power strips).

## Extron Warranty

Extron Electronics warrants this product against defects in materials and workmanship for a period of three years from the date of purchase. In the event of malfunction during the warranty period attributable directly to faulty workmanship and/or materials, Extron Electronics will, at its option, repair or replace said products or components, to whatever extent it shall deem necessary to restore said product to proper operating condition, provided that it is returned within the warranty period, with proof of purchase and description of malfunction to:

**USA, Canada, South America, and Central America:**

Extron Electronics  
1001 East Ball Road  
Anaheim, CA 92805  
U.S.A.

**Japan:**

Extron Electronics, Japan  
Kyodo Building, 16 Ichibancho  
Chiyoda-ku, Tokyo 102-0082  
Japan

**Europe, Africa, and the Middle East:**

Extron Europe  
Hanzeboulevard 10  
3825 PH Amersfoort  
The Netherlands

**China:**

Extron China  
686 Ronghua Road  
Songjiang District  
Shanghai 201611  
China

**Asia:**

Extron Asia  
135 Joo Seng Road, #04-01  
PM Industrial Bldg.  
Singapore 368363  
Singapore

**Middle East:**

Extron Middle East  
Dubai Airport Free Zone  
F12, PO Box 293666  
United Arab Emirates, Dubai

This Limited Warranty does not apply if the fault has been caused by misuse, improper handling care, electrical or mechanical abuse, abnormal operating conditions, or modifications were made to the product that were not authorized by Extron.

**NOTE:** If a product is defective, please call Extron and ask for an Application Engineer to receive an RA (Return Authorization) number. This will begin the repair process.

**USA:** (714) 491-1500  
**Asia:** 65.6383.4400

**Europe:** 31.33.453.4040  
**Japan:** 81.3.3511.7655

Units must be returned insured, with shipping charges prepaid. If not insured, you assume the risk of loss or damage during shipment. Returned units must include the serial number and a description of the problem, as well as the name of the person to contact in case there are any questions.

Extron Electronics makes no further warranties either expressed or implied with respect to the product and its quality, performance, merchantability, or fitness for any particular use. In no event will Extron Electronics be liable for direct, indirect, or consequential damages resulting from any defect in this product even if Extron Electronics has been advised of such damage.

Please note that laws vary from state to state and country to country, and that some provisions of this warranty may not apply to you.

| Extron <b>USA - West</b><br>Headquarters  | Extron <b>USA - East</b>  | Extron <b>Europe</b>   | Extron <b>Asia</b>   | Extron <b>Japan</b>                        | Extron <b>China</b>   | Extron <b>Middle East</b>                | Extron <b>Korea</b>                        | Extron <b>India</b>   |
|---|---|--|--|--|---|--|--|---|
| +800.633.9876<br>Inside USA/Canada Only<br><br>+1.714.491.1500<br>FAX:<br>+1.714.491.1517 | +800.633.9876<br>Inside USA/Canada Only<br><br>+1.919.863.1794<br>FAX:<br>+1.919.863.1797 | +800.3987.6673<br>Inside Europe Only<br><br>+31.33.453.4040<br>FAX:<br>+31.33.453.4050 | +800.7339.8766<br>Inside Asia Only<br><br>+65.6383.4400<br>FAX:<br>+65.6383.4664 | +81.3.3511.7655<br>FAX:<br>+81.3.3511.7656 | +4000.EXTRON<br>+4000.398766<br>Inside China Only<br><br>+86.21.3760.1568<br>FAX:<br>+86.21.3760.1566 | +971.4.2991800<br>FAX:<br>+971.4.2991880 | +82.2.3444.1571<br>Fax:<br>+82.2.3444.1575 | 1800.3070.3777<br>Inside India Only<br><br>+91-80-3055.3777<br>Fax:<br>+91 80 3055 3737 |

## Free Manuals Download Website

<http://myh66.com>

<http://usermanuals.us>

<http://www.somanuals.com>

<http://www.4manuals.cc>

<http://www.manual-lib.com>

<http://www.404manual.com>

<http://www.luxmanual.com>

<http://aubethermostatmanual.com>

Golf course search by state

<http://golfingnear.com>

Email search by domain

<http://emailbydomain.com>

Auto manuals search

<http://auto.somanuals.com>

TV manuals search

<http://tv.somanuals.com>