

User's Manual



MGP 464 MGP 464 DI MGP 464 HD-SDI

Multi-Graphic Processor

Precautions

Safety Instructions • English



This symbol is intended to alert the user of important operating and maintenance (servicing) instructions in the literature provided with the equipment.



This symbol is intended to alert the user of the presence of uninsulated dangerous voltage within the product's enclosure that may present a risk of electric shock.

Caution

Read Instructions • Read and understand all safety and operating instructions before using the equipment.

Retain Instructions • The safety instructions should be kept for future reference.

Follow Warnings • Follow all warnings and instructions marked on the equipment or in the user information.

Avoid Attachments • Do not use tools or attachments that are not recommended by the equipment manufacturer because they may be hazardous.

Consignes de Sécurité • Français



Ce symbole sert à avertir l'utilisateur que la documentation fournie avec le matériel contient des instructions importantes concernant l'exploitation et la maintenance (réparation).



Ce symbole sert à avertir l'utilisateur de la présence dans le boîtier de l'appareil de tensions dangereuses non isolées posant des risques d'électrocution.

Attention

Lire les instructions • Prendre connaissance de toutes les consignes de sécurité et d'exploitation avant d'utiliser le matériel.

Conservier les instructions • Ranger les consignes de sécurité afin de pouvoir les consulter à l'avenir.

Respecter les avertissements • Observer tous les avertissements et consignes marqués sur le matériel ou présentés dans la documentation utilisateur.

Eviter les pièces de fixation • Ne pas utiliser de pièces de fixation ni d'outils non recommandés par le fabricant du matériel car cela risquerait de poser certains dangers.

Sicherheitsanleitungen • Deutsch



Dieses Symbol soll dem Benutzer in der im Lieferumfang enthaltenen Dokumentation besonders wichtige Hinweise zur Bedienung und Wartung (Instandhaltung) geben.



Dieses Symbol soll den Benutzer darauf aufmerksam machen, daß im Inneren des Gehäuses dieses Produktes gefährliche Spannungen, die nicht isoliert sind und die einen elektrischen Schock verursachen können, herrschen.

Achtung

Lesen der Anleitungen • Bevor Sie das Gerät zum ersten Mal verwenden, sollten Sie alle Sicherheits- und Bedienungsanleitungen genau durchlesen und verstehen.

Aufbewahren der Anleitungen • Die Hinweise zur elektrischen Sicherheit des Produktes sollten Sie aufbewahren, damit Sie im Bedarfsfall darauf zurückgreifen können.

Befolgen der Warnhinweise • Befolgen Sie alle Warnhinweise und Anleitungen auf dem Gerät oder in der Benutzerdokumentation.

Keine Zusatzgeräte • Verwenden Sie keine Werkzeuge oder Zusatzgeräte, die nicht ausdrücklich vom Hersteller empfohlen wurden, da diese eine Gefahrenquelle darstellen können.

Instrucciones de seguridad • Español



Este símbolo se utiliza para advertir al usuario sobre instrucciones importantes de operación y mantenimiento (o cambio de partes) que se desean destacar en el contenido de la documentación suministrada con los equipos.



Este símbolo se utiliza para advertir al usuario sobre la presencia de elementos con voltaje peligroso sin protección aislante, que puedan encontrarse dentro de la caja o alojamiento del producto, y que puedan representar riesgo de electrocución.

Precaucion

Leer las instrucciones • Leer y analizar todas las instrucciones de operación y seguridad, antes de usar el equipo.

Conservar las instrucciones • Conservar las instrucciones de seguridad para futura consulta.

Obedecer las advertencias • Todas las advertencias e instrucciones marcadas en el equipo o en la documentación del usuario, deben ser obedecidas.

Evitar el uso de accesorios • No usar herramientas o accesorios que no sean específicamente recomendados por el fabricante, ya que podrían implicar riesgos.

安全须知 • 中文



这个符号提示用户该设备用户手册中有重要的操作和维护说明。



这个符号警告用户该设备机壳内有暴露的危险电压，有触电危险。

注意

阅读说明书 • 用户使用该设备前必须阅读并理解所有安全和使用说明。

保存说明书 • 用户应保存安全说明书以备将来使用。

遵守警告 • 用户应遵守产品和用户指南上的所有安全和操作说明。

避免追加 • 不要使用该产品厂商没有推荐的工具或追加设备，以避免危险。

Warning

Power sources • This equipment should be operated only from the power source indicated on the product. This equipment is intended to be used with a main power system with a grounded (neutral) conductor. The third (grounding) pin is a safety feature, do not attempt to bypass or disable it.

Power disconnection • To remove power from the equipment safely, remove all power cords from the rear of the equipment, or the desktop power module (if detachable), or from the power source receptacle (wall plug).

Power cord protection • Power cords should be routed so that they are not likely to be stepped on or pinched by items placed upon or against them.

Servicing • Refer all servicing to qualified service personnel. There are no user-serviceable parts inside. To prevent the risk of shock, do not attempt to service this equipment yourself because opening or removing covers may expose you to dangerous voltage or other hazards.

Slots and openings • If the equipment has slots or holes in the enclosure, these are provided to prevent overheating of sensitive components inside. These openings must never be blocked by other objects.

Lithium battery • There is a danger of explosion if battery is incorrectly replaced. Replace it only with the same or equivalent type recommended by the manufacturer. Dispose of used batteries according to the manufacturer's instructions.

Avertissement

Alimentations • Ne faire fonctionner ce matériel qu'avec la source d'alimentation indiquée sur l'appareil. Ce matériel doit être utilisé avec une alimentation principale comportant un fil de terre (neutre). Le troisième contact (de mise à la terre) constitue un dispositif de sécurité : n'essayez pas de la contourner ni de la désactiver.

Déconnexion de l'alimentation • Pour mettre le matériel hors tension sans danger, déconnectez tous les cordons d'alimentation de l'arrière de l'appareil ou du module d'alimentation de bureau (s'il est amovible) ou encore de la prise secteur.

Protection du cordon d'alimentation • Acheminer les cordons d'alimentation de manière à ce que personne ne risque de marcher dessus et à ce qu'ils ne soient pas écrasés ou pincés par des objets.

Réparation-maintenance • Faire exécuter toutes les interventions de réparation-maintenance par un technicien qualifié. Aucun des éléments internes ne peut être réparé par l'utilisateur. Afin d'éviter tout danger d'électrocution, l'utilisateur ne doit pas essayer de procéder lui-même à ces opérations car l'ouverture ou le retrait des couvercles risquent de l'exposer à de hautes tensions et autres dangers.

Fentes et orifices • Si le boîtier de l'appareil comporte des fentes ou des orifices, ceux-ci servent à empêcher les composants internes sensibles de surchauffer. Ces ouvertures ne doivent jamais être bloquées par des objets.

Lithium Batterie • Il a danger d'explosion s'il y a remplacement incorrect de la batterie. Remplacer uniquement avec une batterie du même type ou d'un type équivalent recommandé par le constructeur. Mettre au rebut les batteries usagées conformément aux instructions du fabricant.

Vorsicht

Stromquellen • Dieses Gerät sollte nur über die auf dem Produkt angegebene Stromquelle betrieben werden. Dieses Gerät wurde für eine Verwendung mit einer Hauptstromleitung mit einem geerdeten (neutralen) Leiter konzipiert. Der dritte Kontakt ist für einen Erdschluß, und stellt eine Sicherheitsfunktion dar. Dieses sollte nicht umgangen oder außer Betrieb gesetzt werden.

Stromunterbrechung • Um das Gerät auf sichere Weise vom Netz zu trennen, sollten Sie alle Netzkabel aus der Rückseite des Gerätes, aus der externen Stromversorgung (falls dies möglich ist) oder aus der Wandsteckdose ziehen.

Schutz des Netzkabels • Netzkabel sollten stets so verlegt werden, daß sie nicht im Weg liegen und niemand darauf treten kann oder Objekte darauf- oder unmittelbar dagegengestellt werden können.

Wartung • Alle Wartungsmaßnahmen sollten nur von qualifiziertem Servicepersonal durchgeführt werden. Die internen Komponenten des Gerätes sind wartungsfrei. Zur Vermeidung eines elektrischen Schocks versuchen Sie in keinem Fall, dieses Gerät selbst öffnen, da beim Entfernen der Abdeckungen die Gefahr eines elektrischen Schlags und/oder andere Gefahren bestehen.

Schlitze und Öffnungen • Wenn das Gerät Schlitze oder Löcher im Gehäuse aufweist, dienen diese zur Vermeidung einer Überhitzung der empfindlichen Teile im Inneren. Diese Öffnungen dürfen niemals von anderen Objekten blockiert werden.

Lithium-Batterie • Explosionsgefahr, falls die Batterie nicht richtig ersetzt wird. Ersetzen Sie verbrauchte Batterien nur durch den gleichen oder einen vergleichbaren Batterietyp, der auch vom Hersteller empfohlen wird. Entsorgen Sie verbrauchte Batterien bitte gemäß den Herstelleranweisungen.

Advertencia

Alimentación eléctrica • Este equipo debe conectarse únicamente a la fuente/tipo de alimentación eléctrica indicada en el mismo. La alimentación eléctrica de este equipo debe provenir de un sistema de distribución general con conductor neutro a tierra. La tercera pata (puesta a tierra) es una medida de seguridad, no puentearla ni eliminarla.

Desconexión de alimentación eléctrica • Para desconectar con seguridad la acometida de alimentación eléctrica al equipo, desenchufar todos los cables de alimentación en el panel trasero del equipo, o desenchufar el módulo de alimentación (si fuera independiente), o desenchufar el cable del receptáculo de la pared.

Protección del cables de alimentación • Los cables de alimentación eléctrica se deben instalar en lugares donde no sean pisados ni apretados por objetos que se puedan apoyar sobre ellos.

Reparaciones/mantenimiento • Solicitar siempre los servicios técnicos de personal calificado. En el interior no hay partes a las que el usuario deba acceder. Para evitar riesgo de electrocución, no intentar personalmente la reparación/mantenimiento de este equipo, ya que al abrir o extraer las tapas puede quedar expuesto a voltajes peligrosos u otros riesgos.

Ranuras y aberturas • Si el equipo posee ranuras o orificios en su caja/alojamiento, es para evitar el sobrecalentamiento de componentes internos sensibles. Estas aberturas nunca se deben obstruir con otros objetos.

Batería de litio • Existe riesgo de explosión si esta batería se coloca en la posición incorrecta. Cambiar esta batería únicamente con el mismo tipo (o su equivalente) recomendado por el fabricante. Desachar las baterías usadas siguiendo las instrucciones del fabricante.

警告

电源 • 该设备只能使用产品上标明的电源。设备必须使用有地线的供电系统供电。第三条线（地线）是安全设施，不能不用或跳过。

拔掉电源 • 为安全地从设备拔掉电源，请拔掉所有设备后或桌面电源的电源线，或任何接到市电系统的电源线。

电源线保护 • 妥善布线，避免被踩踏，或重物挤压。

维护 • 所有维修必须由认证的维修人员进行。设备内部没有用户可以更换的零件。为避免出现触电危险不要自己试图打开设备盖子维修该设备。

通风孔 • 有些设备机壳上有通风槽或孔，它们是用来防止机内敏感元件过热。不要有任何东西挡住通风孔。

锂电池 • 不正确的更换电池会有爆炸的危险。必须使用与厂家推荐的相同或相近型号的电池。按照生产厂家的建议处理废弃电池。

FCC Class A Notice

This equipment has been tested and found to comply with the limits for a Class A digital device, pursuant to part 15 of the FCC Rules. Operation is subject to the following two conditions: (1) this device may not cause harmful interference, and (2) this device must accept any interference received, including interference that may cause undesired operation. The Class A limits are designed to provide reasonable protection against harmful interference when the equipment is operated in a commercial environment. This equipment generates, uses, and can radiate radio frequency energy and, if not installed and used in accordance with the instruction manual, may cause harmful interference to radio communications. Operation of this equipment in a residential area is likely to cause harmful interference, in which case the user will be required to correct the interference at his own expense.



Table of Contents

Chapter One • Introduction	1-1
About This Manual	1-2
About the MGP 464 Multi-Graphic Processor	1-2
Features	1-2
Application Diagrams	1-4
Chapter Two • Installation	2-1
Installation Overview	2-2
Mounting the MGP 464	2-2
Tabletop use	2-2
Rack mounting	2-2
UL guidelines for rack mounting	2-2
Rack mounting procedure	2-3
Installing or Replacing Button Labels	2-4
Rear Panel Features	2-5
Chapter Three • Operation	3-1
Front Panel Features	3-2
Power-up and Default Cycle	3-4
Window Select Buttons	3-5
Input Selection	3-5
Selecting an input	3-5
Muting an input	3-5
Menus, Configuration, and Adjustments	3-6
Menu system overview	3-6
Using the menus	3-6
Auto Image menu	3-8
Input Configuration menu	3-9
Input configuration submenu adjustments	3-10
Output Configuration menu	3-11
Resolution and Refresh Rate submenu	3-12
Output Type submenu	3-12
Sync Polarity submenu	3-13
Window Configuration menu	3-13
Window Priority submenu	3-13
Window Border submenus	3-14
Window Effect submenu	3-14
Available effects	3-14
Effect Duration submenu	3-15
Background Capture menu	3-16
Memory space for background files	3-16
Saving a background to memory	3-16
Recalling a background from memory	3-17

Table of Contents, cont'd

Comm./IP Configuration menu	3-17
Viewing serial port and IP settings.....	3-17
Making changes to the serial port and IP configuration.....	3-18
Advanced Configuration menu	3-19
Background Color submenu	3-19
Blue Mode submenu	3-19
Test Pattern submenu.....	3-20
Internal Temperature screen.....	3-21
Factory Default submenu.....	3-21
Adding and Configuring Window Text	3-21
Picture Controls	3-21
Adjusting the picture controls	3-21
Picture Controls table.....	3-22
Auto Memories	3-23
Memory Presets	3-23
Window presets.....	3-23
Saving a window preset.....	3-23
Recalling a window preset.....	3-24
Default presets	3-25
Input presets.....	3-25
Additional Features	3-26
Freeze mode	3-26
Locking the front panel (executive mode).....	3-26
Resetting	3-26
Chapter Four • Software Configuration and Control	4-1
Setting Up Serial Communication	4-2
Connector pin assignments	4-2
Using Simple Instruction Set (SIS) Commands	4-3
Host-to-MGP communications	4-3
MGP-initiated messages.....	4-3
Error responses.....	4-4
Telnet and Web communications	4-4
Symbol definitions	4-6
Windows®-based Control Software	4-36
Installing the software	4-36
Downloading the MGP 464 software from the Web.....	4-38
Starting the control program.....	4-39
Chapter Five • HTML Configuration and Control	5-1
Accessing the Web Pages	5-2
Viewing System Status	5-3

Using the Configuration Page	5-4
System Settings screen	5-4
Scaler I/O Settings screen	5-5
Configuring the inputs.....	5-5
Naming inputs.....	5-5
Selecting the video signal type.....	5-6
Configuring the output.....	5-6
Enabling/disabling blue mode	5-7
Window Settings screen.....	5-8
Setting window priority.....	5-9
Passwords screen.....	5-10
Assigning a password	5-10
Clearing a password	5-10
Email Alerts screen.....	5-11
Setting up e-mail alerts.....	5-11
Setting up SMTP authorization	5-12
Firmware Upgrade screen.....	5-12
Determining the current firmware version.....	5-12
Downloading the firmware	5-13
Updating the firmware on the MGP 464	5-13
Using the File Management Page	5-14
Uploading files	5-15
Adding a directory.....	5-15
Other file management activities.....	5-15
Using the Control Page	5-16
Picture Controls screen.....	5-16
Window Selection.....	5-16
Input sections.....	5-17
Window Controls.....	5-18
Image Controls.....	5-18
Presets screen.....	5-20
Window Presets	5-20
Default presets.....	5-21
Naming a window preset.....	5-21
Saving (creating) a window preset.....	5-22
Recalling a window preset.....	5-22
Selecting a window preset transition effect.....	5-22
Input Presets	5-22
Saving (creating) an input preset	5-23
Recalling an input preset	5-23
Using the Background Page	5-23
Selecting a background color.....	5-23
Displaying a background image	5-24
Using a DVI input.....	5-24
Using a bitmap image	5-24
Uploading an image	5-24
Selecting a background image	5-25

Table of Contents, cont'd

Chapter Six • Special Applications	6-1
Application 1: Connecting the MGP 464 to a Matrix Switcher	6-2
Setting up the MGP to work with the switcher	6-3
Using the MGP and the matrix switcher after the MGP is synchronized to the matrix switcher	6-5
Minimizing synchronization problems when not using the Sync to Matrix feature	6-5
Application 2: Connecting Multiple MGP 464s in Succession (Daisy-chaining)	6-6
Setting up MGPs for daisy-chaining	6-7
Appendix A • Specifications, Part Numbers, and Accessories	A-1
Specifications	A-2
Part Numbers and Accessories	A-4
Included parts.....	A-4
Optional accessories	A-4
Appendix B • Firmware Update Guide	B-1
Determining the Firmware Version	B-2
Using the LCD display at power-on	B-2
Using a Web browser	B-2
Using the Windows-based configuration software	B-4
Downloading the firmware	B-4
Updating the Firmware	B-5
Updating using the Web pages	B-5
Updating using the Windows-based control software	B-7
Updating using the Firmware Loader	B-8

All trademarks mentioned in this manual are the properties of their respective owners.

68-1235-01 Rev C
01 09



MGP 464 Multi-Graphic Processor

1 Chapter One

Introduction

About This Manual

About the MGP 464 Multi-Graphic Processor

Features

Application Diagrams

Introduction

About This Manual

This manual discusses how to install, configure, and operate the Extron MGP 464 multi-graphic processor.

Throughout this manual, the terms “MGP 464”, “MGP”, “multi-graphic processor”, and “processor” are used interchangeably to refer to all models of the product.

About the MGP 464 Multi-Graphic Processor

The MGP 464 is a four-window RGB and video signal processor that can display up to four video sources on a single screen in picture-in-picture or picture-by-picture format. The MGP accepts RGB, HDTV, component, S-video, and composite video signals on four fully-configurable inputs and 15 virtual inputs; and has one scaled output. The processor provides switching among inputs and has picture controls and presets.

The MGP 464 DI is an MGP 464 with a DVI input card installed, providing four DVI input connectors. The MGP 464 HD-SDI is an MGP 464 with two HD-SDI inputs and two DVI inputs.

All versions can be controlled remotely via the RS-232/RS-422 interface using Simple Instruction Set (SIS™) commands or the Windows-based control software, or via an Ethernet LAN using the MGP 464's embedded Web pages, SIS commands, or the Windows-based control software.

Features

Four windows — Up to four windows can be shown on a single display simultaneously, allowing up to four video and computer sources to be viewed at once.

Inputs — The MGP 464 has four fully configurable video inputs, which accept RGB, HDTV, component, S-video, and composite video signals. In addition to these four configurable inputs, the MGP 464 DI has four DVI inputs and the MGP 464 HD-SDI has two HD-SDI and two DVI inputs.

DVI-D Background input — A DVI input is provided on all models as a means to display live video from a DVI source as a background.

Virtual inputs — 15 virtual inputs can be configured through software to accept standard definition component video, S-video, and composite video.

Output — All MGP 464 models have one scaled output, available on a set of five BNC connectors for RGB and a DVI-I connector for DVI.

Picture controls — Picture controls allow you to adjust the size, position, brightness, contrast, color, tint, detail, and zoom for each window.

Window and input presets — Window presets save sizing, positioning, and priority information. Input presets save input signal type information and picture control settings.

Window transition effects — Six types of window transition effects (22 different effects altogether) seamlessly mute and unmute (close and open) the four windows.

Freeze control — Freeze control freezes (locks) a window to the current image.

3:2 pulldown detection for NTSC video and 2:2 film detection for PAL — These advanced film mode processing features help maximize image detail and sharpness for video sources that originated from film.

When film is converted to NTSC video, the film frame rate has to be matched to the video frame rate in a process called 3:2 pulldown. Jaggies and other image artifacts can result if conventional deinterlacing techniques are used on film-source video.

The MGP 464's advanced film mode processing recognizes signals that originated from film. The MGP then applies video processing algorithms that optimize the conversion of video made in the 3:2 pulldown process. This results in richly detailed images with sharply defined lines.

A similar process, 2:2 film detection, is used for PAL film-source video.

Background image capture, save, and recall — Background Capture enables you to capture and save the image currently on the output screen. You can then recall the captured image and display it as a background later.

Auto Image™ — Auto Image automatically sizes, centers, and optimizes the image to the scaled output rate, filling the window.

Remote operation — The MGP 464 can be operated remotely via the RS-232/422 interface using the Windows-based control software or SIS commands, or via the Ethernet interface using the embedded Web pages, SIS commands, or the Windows-based control software.

Rack mounting — The 2U high and full rack wide metal enclosure can be rack mounted using the included rack/through-desk mounting brackets.

Front panel security lockout (executive mode) — Locks the front panel controls to prevent accidental changes to the unit's settings.

RGB and video scaling — All sources are scaled to a single output rate.

Introduction, cont'd

Application Diagrams

The following application diagrams show examples of how devices may be connected to the MGP 464 and the MGP 464 DI.

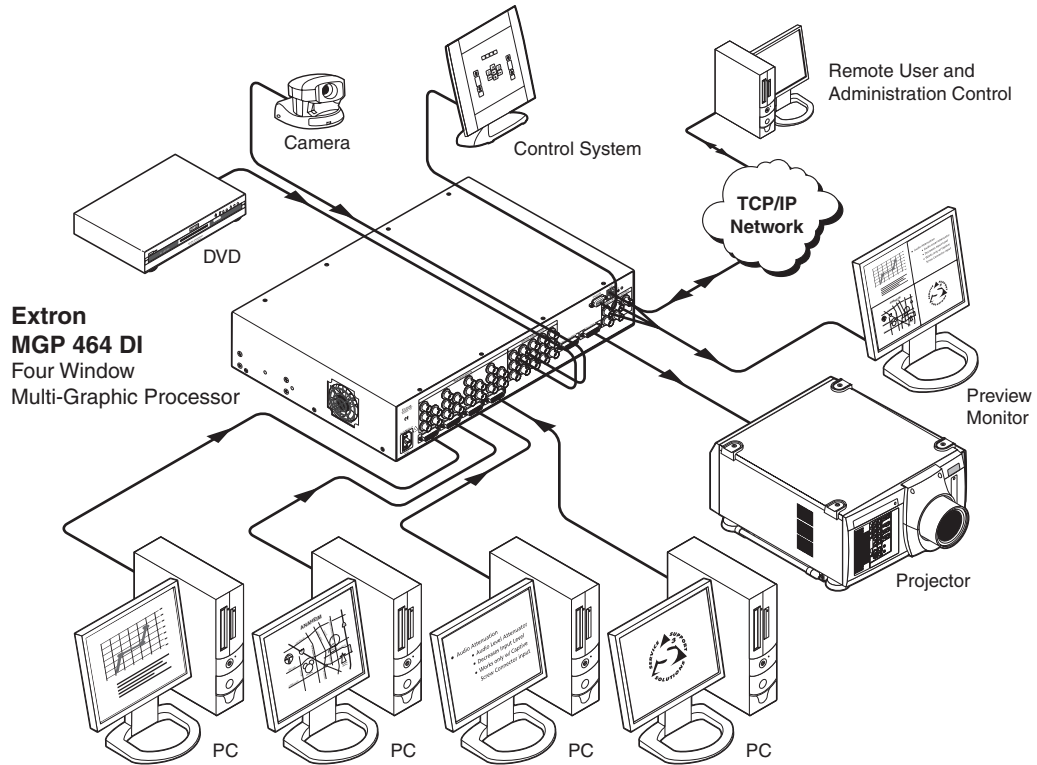

Connection diagram for an MGP 464 DI

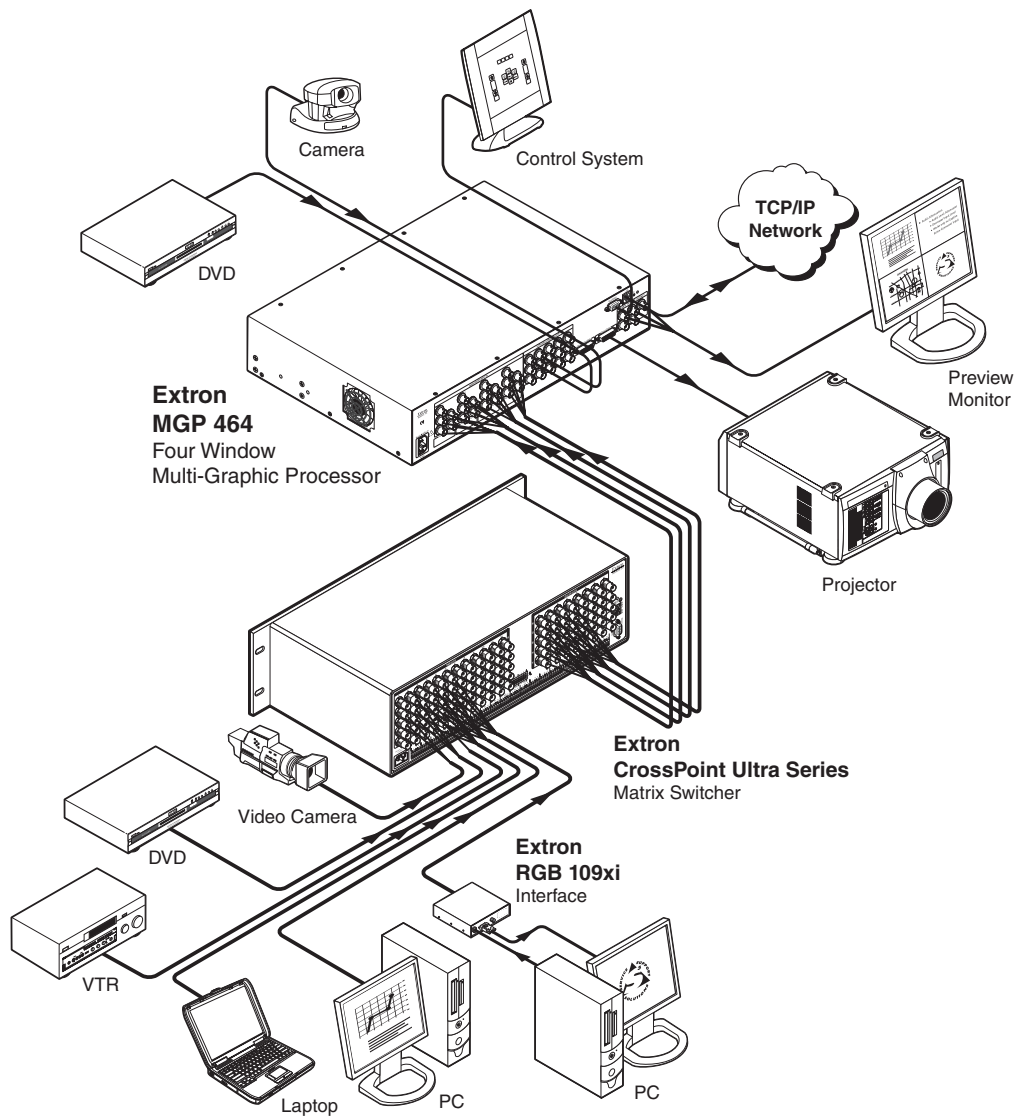

Connection diagram for an MGP 464 (with a CrossPoint Ultra Matrix Switcher)

Introduction, cont'd



MGP 464 Multi-Graphic Processor

Chapter Two

Installation

Installation Overview

Mounting the MGP 464

Installing or Replacing Button Labels

Rear Panel Features

Installation

Installation Overview

The MGP 464 processor can be connected to as many as 19 input devices simultaneously, and up to two output devices. Follow these steps to install the MGP 464:

- 1 Disconnect power to the MGP, and turn off all other devices that will be connected.
- 2 If desired, mount the MGP. See "Mounting the MGP 464," below.
- 3 Attach video input devices to the MGP 464, using the four sets of BNC connectors for the fully configurable inputs and/or the 15 BNC connectors for the virtual inputs.

For the MGP 464 DI, connect up to four input sources to the DVI-I and/or the BNC connectors as desired. For the MGP 464 HD-SDI, connect up to four input sources to the two HD-SDI connectors, the two DVI-I connectors, and/or the four BNC connectors, in any desired combination.

- 4 Connect one or two output devices to the RGBHV/YUV BNC output connectors and/or to the DVI-I output connector.
- 5 If the MGP 464 will be connected to a computer or to a host controller for remote operation, connect the host's RS-232 cable to the processor's 9-pin RS-232/422 D-sub connector on the rear panel; or use the optional 9-pin female-to-2.5 mm TRS cable to connect the host to the MGP's front panel RS-232 Config port.
- 6 Connect an active LAN Ethernet cable to the RJ-45 port on the MGP's rear panel to establish a link to the network.
- 7 Power up the input and output devices, then connect power to the MGP.

Mounting the MGP 464

Tabletop use

Four self-adhesive rubber feet are included with the MGP 464. For tabletop use, attach one foot to each corner of the bottom side of the unit and place the unit in the desired location.

Rack mounting

UL guidelines for rack mounting

The following Underwriters Laboratories (UL) guidelines pertain to the installation of the MGP 464 into a rack:

- **Elevated operating ambient temperature** — If the equipment is installed in a closed or multi-unit rack assembly, the operating ambient temperature of the rack environment may be greater than room ambient. Therefore, consider installing the equipment in an environment compatible with the maximum ambient temperature (T_{ma}) specified by the manufacturer.
- **Reduced air flow** — Install the equipment in the rack so that the amount of air flow required for safe operation of the equipment is not compromised.
- **Mechanical loading** — Mount the equipment in the rack so that uneven mechanical loading does not create a hazardous condition.

-
- **Circuit overloading** — When connecting the equipment to the supply circuit, consider the connection of the equipment to the supply circuit and the effect that circuit overloading might have on overcurrent protection and supply wiring. Consider equipment nameplate ratings when addressing this concern.
 - **Reliable earthing (grounding)** — Maintain reliable grounding of rack-mounted equipment. Pay particular attention to supply connections other than direct connections to the branch circuit (such as the use of power strips).

Rack mounting procedure

For optional rack mounting, do not install the rubber feet. To mount the MGP 464 in a rack,

1. Attach the included rack/through-desk mounting brackets (part #70-155-01) to the unit using eight machine screws supplied with the mounting kit. (See the illustration on the next page.)
2. Insert the unit into the rack and align the holes in the mounting brackets with the holes in the rack. Use four machine screws to attach the brackets to the rack.

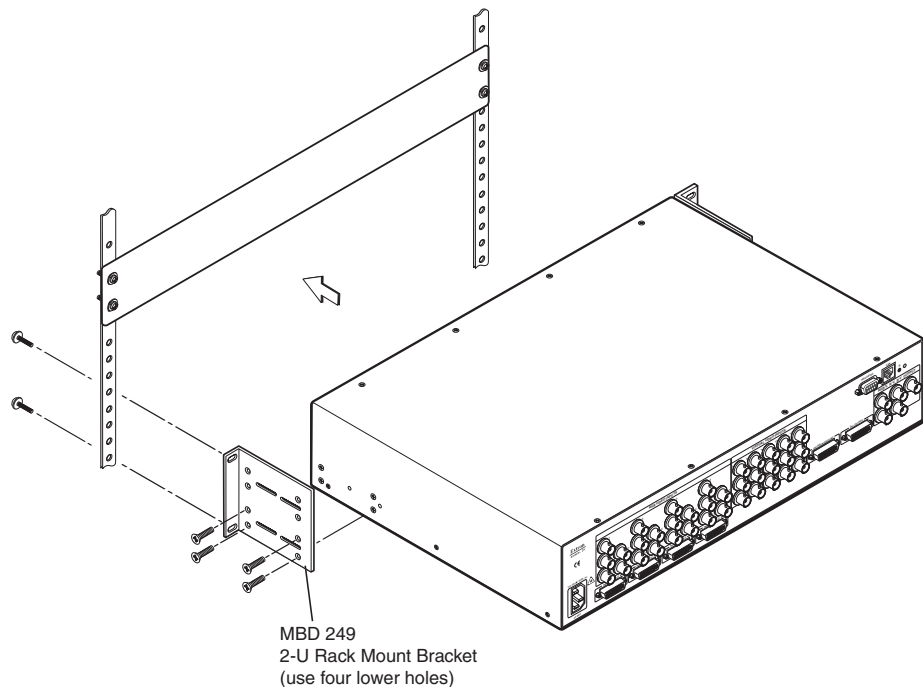

Rack mounting the MGP 464

Installation, cont'd

Installing or Replacing Button Labels

The button caps are pre-labeled for your convenience by default. However, you can replace them with button labels that you create, using the Button-Label Generator or other button label software.

The button assembly consists of a clear lens cap, the button label, and a white diffuser. (See the illustrations at right and below.) Remove the button assembly from the MGP as follows:

1. Make any desired button labels and cut them out.
2. Remove the button assembly by inserting a small, flat-bladed screwdriver between the button's base and the diffuser to gently pry the button assembly off the button plunger, as shown in the drawing at right.
3. Locate the small corner notch on the lens cap, and slide the screwdriver between the lens cap and the diffuser. (See ③ in the illustration below.)
4. Using a rotating motion of the screwdriver, carefully pry the two pieces apart. (See ④ in the illustration below.)

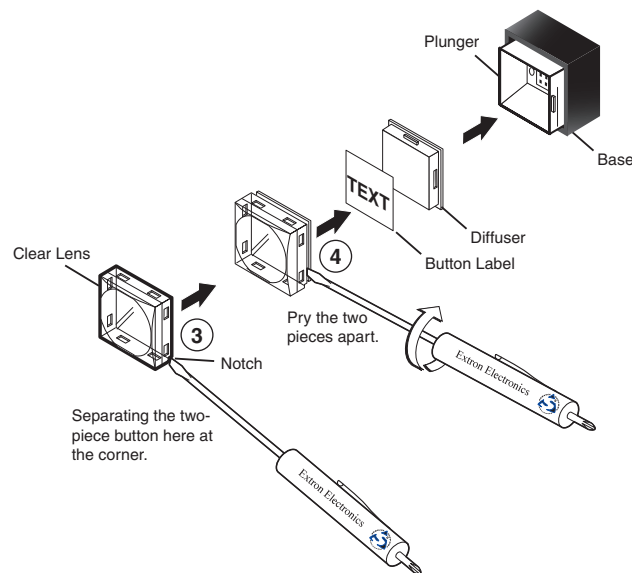
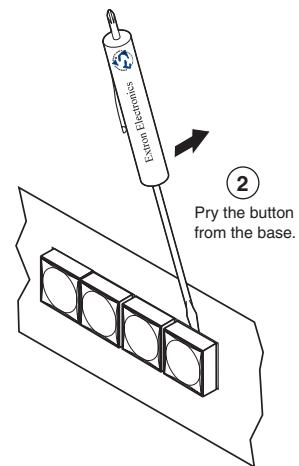

Replacing a button label

5. Lift out the transparent square label that you want to replace, being careful not to damage the circuits beneath it. You may need to use the small screwdriver to gently pry the label out.
6. Insert one of the new labels you created in step 1 into the clear button cap, align the white backing plate with the cap, and firmly snap it into place.
7. Gently, but firmly, press the reassembled button into place on the MGP front panel.
8. Repeat steps 1 through 7 as needed to relabel other buttons.

Rear Panel Features

The diagram below show the rear panel of the MGP 464 DI, which has four DVI-I input connectors, and the MGP 464 HD-SDI, which has two HD-SDI and two DVI-I input connectors. The standard MGP 464 does not have these DVI/HD-SDI input connectors (although it does have DVI Output and DVI Background connectors). In all other respects the rear panels are identical for all three models.

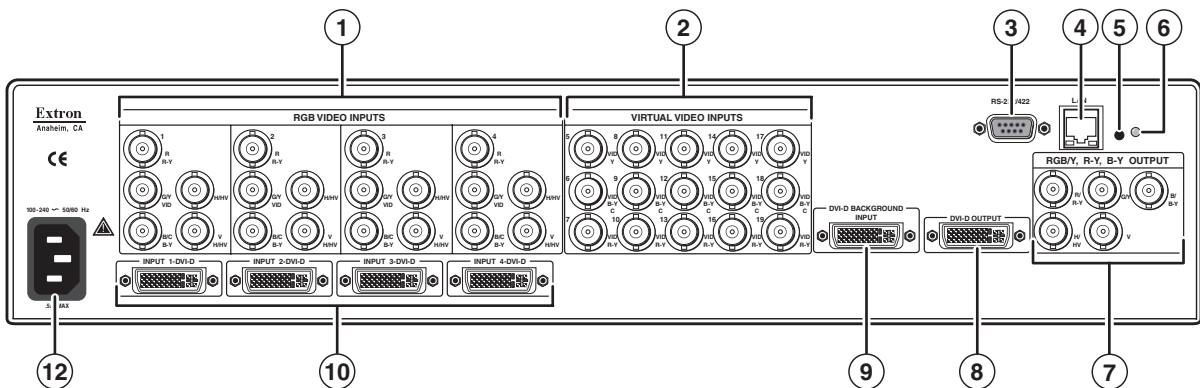

MGP 464 DI back panel

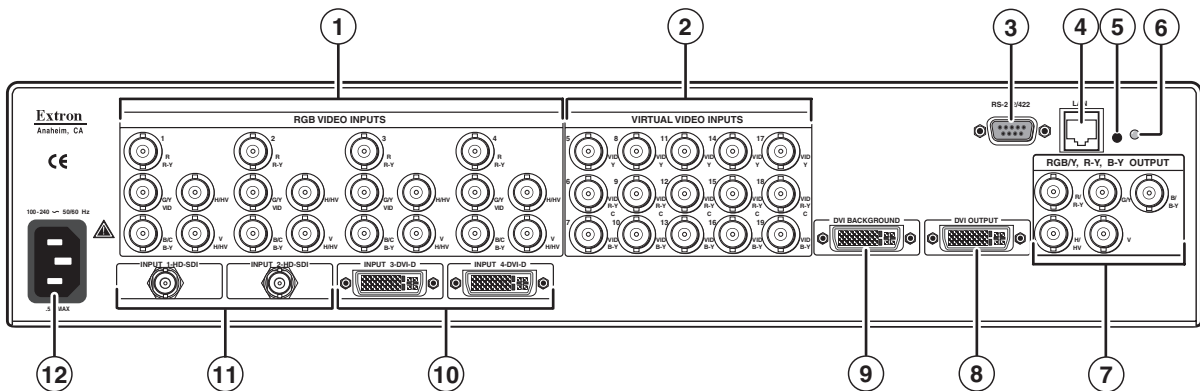

MGP 464 HD-SDI back panel

- ① **Inputs 1 through 4** — Plug RGB, high or standard definition component video, S-video, or composite video sources into these fully configurable BNC connectors, as shown in the following diagram. These connectors can be configured for the desired signal types via the front panel, the Windows-based control software, SIS commands, or the MGP 464 Web pages.

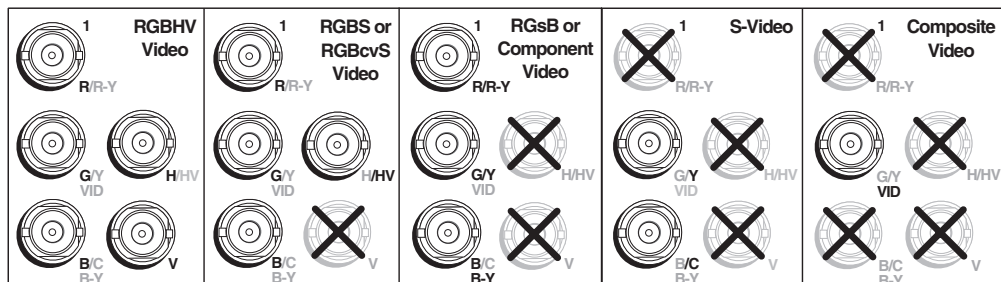

Connecting to RGB/HD/VIDEO inputs 1 through 4

Installation, cont'd

- ② **Virtual inputs (inputs 5 through 19)** — Connect standard definition component video, S-video, and/or composite video sources to these BNC connectors. The 15 connectors for the virtual inputs are arranged in columns of three BNCs.

In each column, you can connect inputs as follows (see the illustration below):

- Up to three composite video inputs (can be plugged into any connector[s] in the column)
- One S-video input and, optionally, one composite video input

NOTE

The S-video must always be connected to the top two BNC connectors. The Y connector must be on top, the C connector in the middle). If desired, a composite video source can be connected to the bottom BNC connector.

- One interlaced component video source (must be connected to all three BNC connectors in the column).

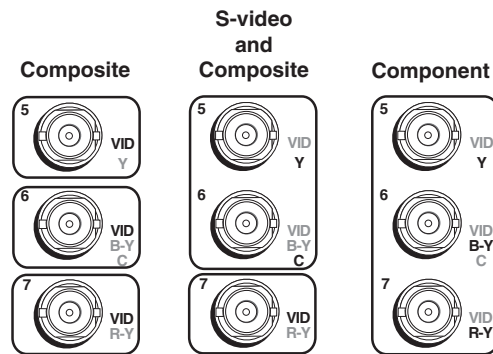

Virtual input connector configuration examples

You can configure these virtual inputs for the desired signal types using the Windows-based control software (see the control software help file), SIS commands (see chapter 4, "Software Configuration and Control"), or the Web pages (see chapter 5, "HTML Configuration and Control"). They cannot be configured via the front panel.

NOTE

When you configure a virtual input as S-video (using two input connectors) or component video (using three input connectors), pressing any one of its equivalent buttons selects the input. For example, if you plug an S-video source into input connectors 8 and 9, pressing either the 8 or the 9 input button selects that input.

- ③ **RS-232/422 connector** — Plug a computer or other RS-232 or RS-422 host device into this connector. Wire the connector as shown on the next page. See chapter 4, "Software Configuration and Control," for more information on controlling the MGP 464 remotely.

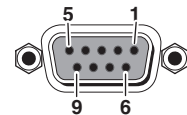

Pin	RS-232 function	Description
1	–	No connection
2	Tx	Transmit data
3	Rx	Receive data
4	–	No connection
5	Gnd	Signal ground
6	–	No connection
7	–	No connection
8	–	No connection
9	–	No connection

Pin	RS-422 function	Description
1	–	No connection
2	Tx-	Transmit ground
3	Rx-	Receive ground
4	–	No connection
5	Gnd	Signal ground
6	–	No connection
7	Rx+	Receive data
8	Tx+	Transmit data
9	–	No connection

NOTE The MGP 464 also has an RS-232-only Config port on a 2.5 mm TRS connector on the front panel. For information on this port, see “Front Panel Features” in chapter 3, “Operation.”

- ④ **LAN connector** — Plug an RJ-45 network cable into this connector to connect the unit to a network (via a switch, hub, or router) or to a single computer.

Activity LED — This yellow LED blinks to indicate network activity.

Link LED — This green LED lights to indicate a good network connection.

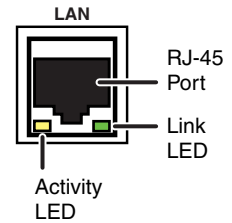

Use a straight-through cable to connect to a network, or a crossover cable to connect directly to a computer.

- For 10BaseT (10 Mbps) networks, use a Cat 3 or better cable.
- For 100BaseT (max. 155 Mbps) networks, use a Cat 5 cable.

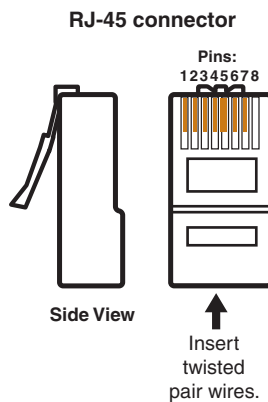

Straight-through Cable (for connection to a switch, hub, or router)			
End 1		End 2	
Pin	Wire Color	Pin	Wire Color
1	white-orange	1	white-orange
2	orange	2	orange
3	white-green	3	white-green
4	blue	4	blue
5	white-blue	5	white-blue
6	green	6	green
7	white-brown	7	white-brown
8	brown	8	brown

Crossover Cable (for direct connection to a PC)			
End 1		End 2	
Pin	Wire Color	Pin	Wire Color
1	white-orange	1	white-green
2	orange	2	green
3	white-green	3	white-orange
4	blue	4	blue
5	white-blue	5	white-blue
6	green	6	orange
7	white-brown	7	white-brown
8	brown	8	brown

Installation, cont'd

You must also configure the LAN port before using it. You can do this by using SIS commands (see "Command/response table for SIS commands" in chapter 4, "Software Configuration and Control") or by using the Comm./IP Configuration menu on the front panel (see "Comm./IP Configuration menu" in chapter 3, "Operation").

LAN port defaults:

- MGP's IP address: 192.168.254.254
- Gateway IP address: 0.0.0.0
- Subnet mask: 255.255.0.0
- DHCP: off

- ⑤ **Reset button** — Pressing this recessed button causes various IP functions and Ethernet connection settings to be reset to the factory defaults.
- ⑥ **Reset LED** — This green LED, located to the upper-right of the reset button, blinks a varying number of times to indicate which reset mode has been entered. See "Resetting the unit" in chapter 3, "Operation," for details.
- ⑦ **BNC output connectors** — Plug an output device into these five BNC connectors, as shown below.

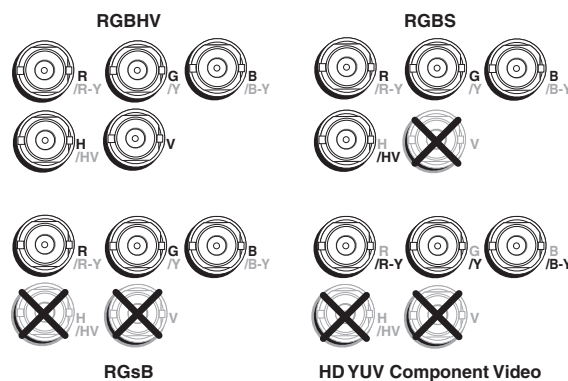

Connecting to output BNC connectors

- ⑧ **DVI output** — Plug a DVI output device into this DVI-I connector.



NOTE Analog RGB is not available on the DVI connector.

NOTE When two output devices are attached (one to each output connector), they both display the same image.

- ⑨ **DVI background input** — Connect a DVI input source to this DVI-I connector in order to display the DVI video source live as a background on your output screen. The four MGP windows are displayed in front of this DVI image. When a DVI background is used, the MGP output is locked to the input rate of the DVI background. This input is not scaled.

NOTE This input connector can be used only to receive the background image. The input is not scaled or processed. To process DVI input signals, you must use the MGP 464 DI model.

-
- ⑩ **DVI inputs** — Connect up to four (MGP 464 DI) or two (MGP 464 HD-SDI) DVI input sources to these DVI input connectors, as an alternative to using the fully-configurable BNC input connectors (①). These inputs are available only on the MGP 464 DI and MGP 464 HD-SDI models, which have the DVI card installed.
 - ⑪ **HD-SDI inputs** — (MGP 464 HD-SDI only) Connect up to two HD-SDI inputs to these HD-SDI input connectors.
 - ⑫ **AC power connector** — Plug the power cord provided with the MGP 464 into this connector to connect the MGP to a 100–250 VAC, 50/60 Hz power source.

Installation, cont'd



MGP 464 Multi-Graphic Processor

Chapter Three

Operation

Front Panel Features

Power-up and Default Cycle

Input Selection

Window Select Buttons

Menus, Configuration, and Adjustments

Picture Controls

Auto Memories

Memory Presets

Additional Features

Operation

You can set up and operate the MGP 464 by using:

- The front panel controls
- A computer, a touch screen panel, or any other device that can send and receive serial communications through either serial port or through the LAN port. Settings can be adjusted through the host computer using Extron's Simple Instruction Set (SIS™) or the Windows-based control software.
- A computer or other device using an Ethernet connection and IP protocol (Telnet or a Web browser).

This chapter discusses the functions available through the front panel. For details on setup and control via RS-232/RS-422, see chapter 4, "Software Configuration and Control"; for Ethernet, see chapter 5, "HTML Configuration and Control."

Front Panel Features

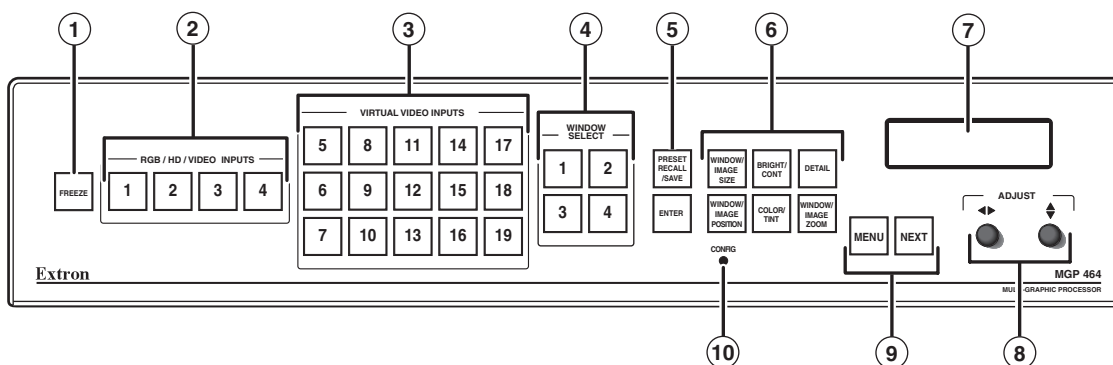

MGP 464 front panel

- ① **Freeze button** — Press this button to freeze the image in the currently selected window on the display. The image remains frozen until the Freeze button is pressed again, or a different input is selected.
- ② **RGB/HD/Video Inputs selection buttons** — Press these buttons to select fully configurable inputs 1 through 4. On the MGP 464 DI, these buttons can also select the four DVI inputs depending on the unit's input configuration. On the MGP 464 HD-SDI, input buttons 1 and 2 can select the HD-SDI inputs and buttons 3 and 4 can select the DVI inputs. When one of these buttons is pressed, its input signal switches to the window that is currently selected.

When an input is selected, pressing its button again mutes the input. The input's signal turns off and the window closes. The button flashes while the input remains muted. To unmute the input, press its input button again.

When an input is muted or unmuted, the window in which it was displayed opens or closes with the currently selected window transition effect. The Window Configuration menu lets you select a transition effect (e.g., dissolve, curtain, or square wipe) with which the window will open or close (the default effect is cut). See "Window Configuration menu," later in this chapter.

- ③ **Virtual video input selection buttons** — Press these buttons to select inputs 5 through 19. These inputs can be configured to accept standard definition component video, S-video, or composite video signals only.

These inputs are referred to as "virtual" inputs because they can be configured as a variety of combinations of component, S-video, and composite video through SIS commands, the Windows-based control software, or the MGP 464 Web pages. They cannot be configured via the front panel.

The virtual input buttons are arranged in five columns of three buttons each, reflecting the arrangement of the virtual input connectors on the rear panel.

Like the buttons for the four fully configurable inputs, the virtual input buttons light when pressed. When you press an input button connected to a component video source, all **three** buttons in its column light. If you press a button connected to an S-video source, the top **two** buttons in the column light. When a composite video source is selected, only one button lights.

- ④ **Window Select buttons** — Press these buttons to select, activate, or adjust one of the four windows. While a window is selected, all picture controls are associated with it.
- ⑤ **Window Preset buttons** — Press the Preset Recall/Save and Enter buttons to save or recall window presets. See “Window Presets,” later in this chapter, for more information.
- ⑥ **Picture control buttons** — Press these buttons to adjust image size, position, brightness, contrast, color, tint, detail, and zoom. See “Picture Controls,” later in this chapter, for further information.”
- ⑦ **LCD screen** — This screen displays messages, menu information, and your selections. See “Menus, Configuration, and Adjustments,” later in this chapter, for more information.
- ⑧ **Adjust knobs** — Turn these horizontal and vertical Adjust knobs to adjust picture controls and to scroll through preset memory slots and submenu options. See “Menus, Configuration, and Adjustments,” later in this chapter, for more information.
- ⑨ **Menu navigation buttons** — Press Menu to access the MGP 464 menu system and step through the menus. From each menu, press Next to step through its submenus. See “Menus, Configuration, and Adjustments,” later in this chapter, for more information.
- ⑩ **Config port** — This configuration port on a 2.5 mm TRS connector is an alternative to the RS-232/422 port on the MGP rear panel; however, unlike the rear panel port, it supports only RS-232. (For a description of the rear panel RS-232/422 port, see “Rear Panel Features” in chapter 2, “Installation”).

Both of the MGP’s serial ports are used for system configuration and control. Commands are received through these ports from the PC, using SIS commands or the Windows-based control software. Both serial ports can be active at the same time.

The protocol for this configuration port is as follows:

- 9600 baud
- 8 data bits
- 1 stop bit
- No parity
- Always RS-232

An optional 2.5 mm TRS configuration cable (part #70-335-01) is available from Extron and can be used to connect your computer to this port. The diagram on the next page shows this cable’s configuration and pin assignments.

Operation, cont'd

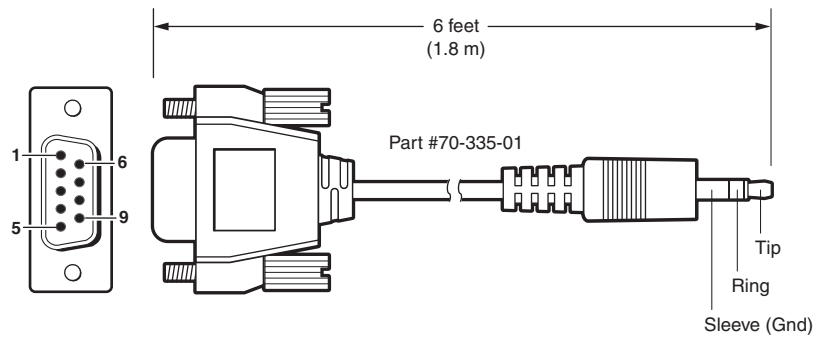

9-pin D	Connection	TRS Plug
Pin 2	Computer's RX line	Tip
Pin 3	Computer's TX line	Ring
Pin 5	Computer's signal ground	Sleeve

Optional 2.5 mm connector cable for the front panel Config port

See chapter 4, "Software Configuration and Control," for details about using the configuration software and the SIS commands to configure the MGP.

Power-up and Default Cycle

When you first plug the MGP 464 into a power source, the LCD screen displays a series of initial messages, followed by the default cycle of screens showing the current input type for each window and the output resolution and refresh rate. These messages continue to cycle on the LCD screen when the menu system is not in use. The following flow diagram shows the order in which these screens appear.

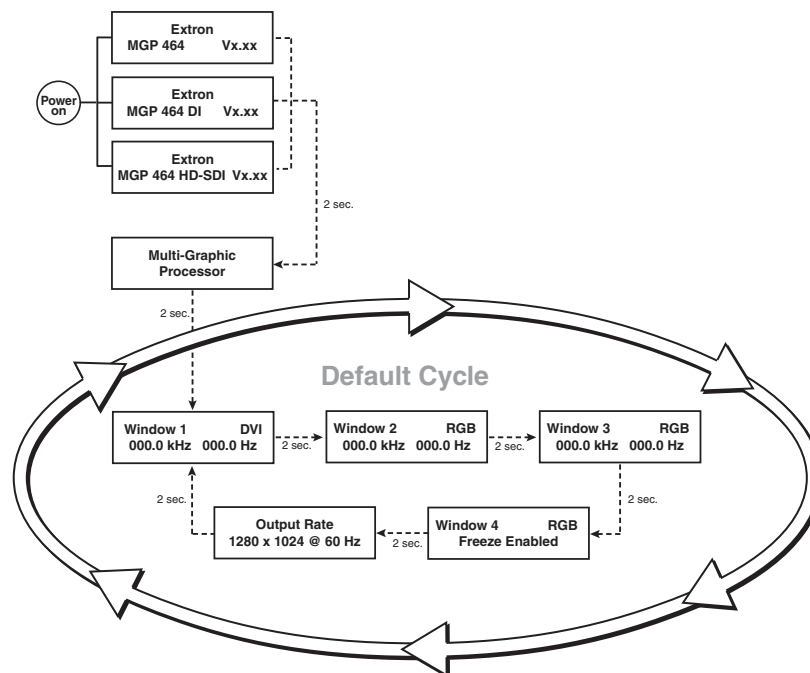

Default cycle example

NOTE From any menu or submenu, the MGP 464 saves all adjustment settings and times out to the default screens after 20 seconds of inactivity.

Window Select Buttons

The MGP 464 front panel contains four Window Select buttons. Use these buttons in conjunction with the Input buttons to specify which window displays an input, or use them with the picture control buttons to specify which window/image will be adjusted.

When you select a picture control, the window whose button was previously selected is affected. (See "Picture Controls," later in this chapter, for information on the available controls.)

To select a window, press its Window Select button, which lights. To deselect a window, press another Window Select button.

Input Selection

The MGP 464 front panel contains a set of four input buttons that enable you to select RGB, HD, and/or video (component, S-video, or composite) inputs for windows 1 through 4. It also contains 15 virtual input buttons that enable you to select only video inputs.

Selecting an input

Before you can select an input, you must first select a window, as follows:

1. Press the Window Select button for the window in which you want the input to be displayed.
2. Press the button with the number of the input you want to display.

For example: If you have a computer connected to input 1 and you want to display the computer's output in window 4, press Window Select button 4, then press Input button 1.

Muting an input

To mute the currently selected input (turn off its signal and close the window on the display), press its Input button again. The button's backlight blinks continuously, which indicates that the input is muted.

When an input is muted or unmuted, the currently selected transition effect (cut, wipe, or dissolve), if any, is used to close or open the window on the output display. See "Window effects submenu" in the "Window Configuration menu" section, later in this chapter, for information on transition effects.

To unmute the input, press its button again. The button's backlight stops flashing and returns to a steady light.

Menus, Configuration, and Adjustments

The MGP 464's menus enable you to configure the processor. The menu navigation buttons (Menu and Next) are located to the lower left of the LCD screen. Press these buttons to cycle through the available menu and submenu options.

Menu system overview

The MGP 464's menu system consists of a main menu with nine options (menus). Each of these nine menus has a set of submenus, which enable you to make desired adjustments. (See the diagram on page 3-7.)

Using the menus

To use the menus to configure the system,

NOTE *If you do not press a button or turn a knob for 20 seconds, the MGP 464 saves any settings you have made and the LCD screen reverts to the default cycle.*

1. **Main menu** — To access the Main menu, press the Menu (left) button, located below and to the left of the LCD screen. The first Main menu option (Auto Image) is displayed on the screen.
2. **Main menu options (menus)** — By repeatedly pressing the Menu button, you cycle through the Main menu options. Press the Menu button repeatedly until the desired menu is displayed.
3. **Submenu options** — When the Main menu item that you want to configure is displayed on the LCD screen, press the Next button (at the right of the Menu button) to cycle through the displayed menu's submenu options.
4. **Adjustments** — The third level of menu selections consists of sub-menu options that are selected by turning the horizontal (◀▶) and vertical (⬆⬇) Adjust knobs. When you have displayed the submenu option that you want to configure, turn the knobs clockwise or counterclockwise to display the parameters available for the selected option.
5. **Implementation** — To save and implement the adjustments you have selected, do one of the following:
 - Press Next to display another submenu option to adjust.
 - Press Menu repeatedly until the Exit menu screen appears, then press Next.
 - Do nothing more, and wait until the LCD screen returns to the default cycle.

Your adjustments remain in effect until you change them or reset the unit to factory defaults (see "Resetting," later in this chapter).

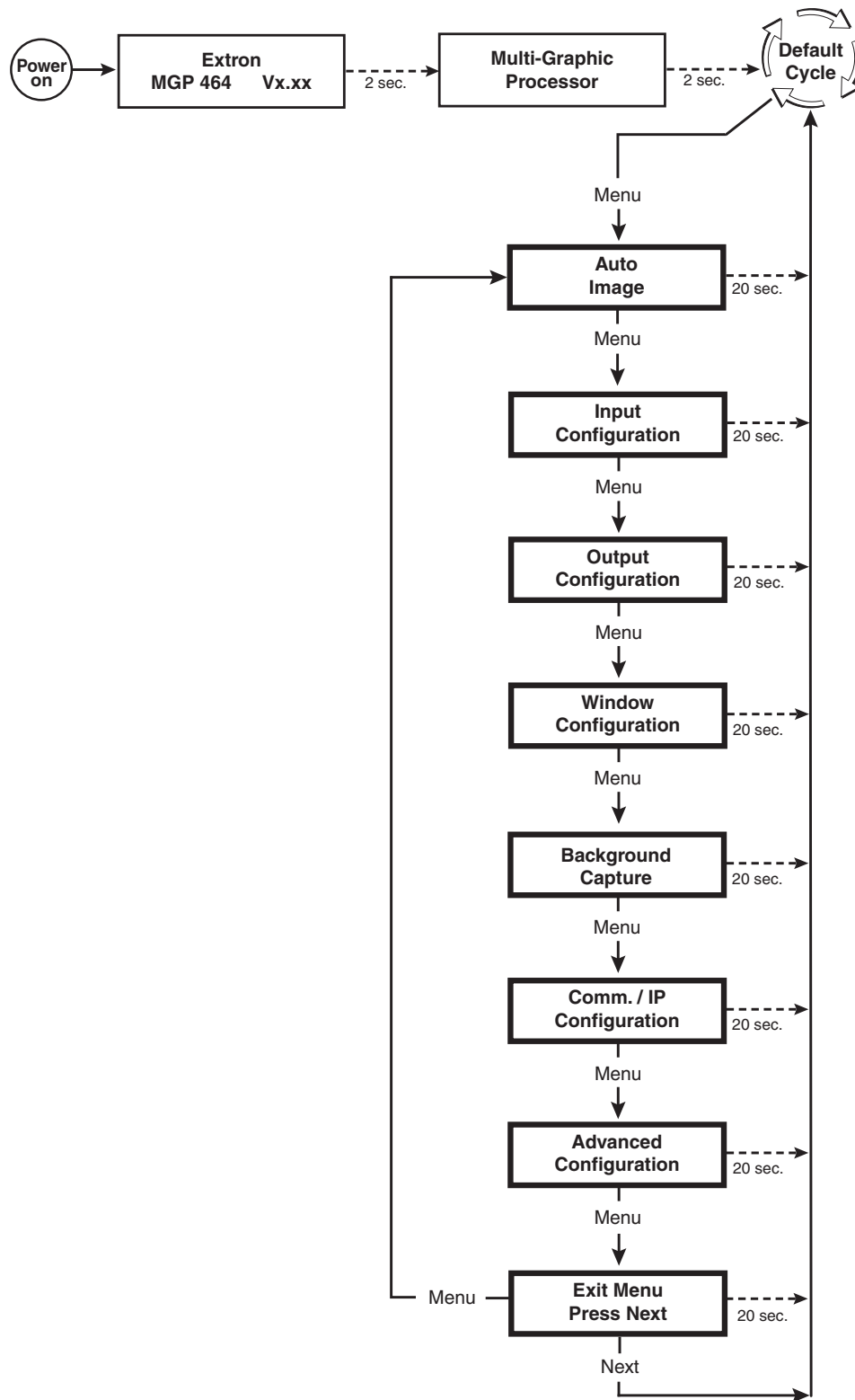

Main menu flow

Auto Image menu

The Auto Image menu causes the MGP 464 to perform an automatic image adjustment in the selected window. Auto Image measures where the active area starts and stops, and adjusts input sampling accordingly, so that the image fills the window.

When an input is connected, the processor measures the sync frequencies of the incoming video source and sets the active image area, total image area, and sampling frequency according to a table stored on the MGP. If an unknown input is connected to the MGP, the processor measures and estimates the resolution of the incoming video. If the processor's estimate proves inaccurate, the Auto Image function makes measurements to more accurately set up the input sampling.

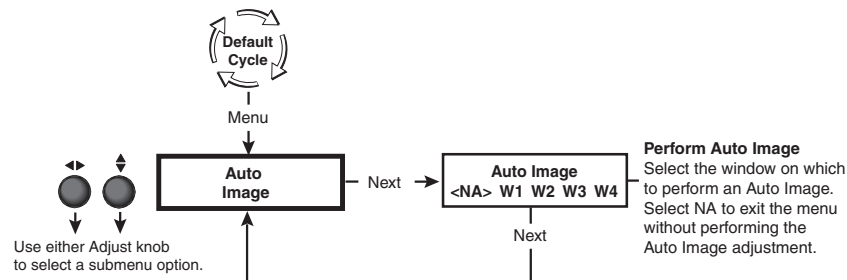

Auto Image menu flow

To perform an Auto Image adjustment,

1. Press the Menu button once to display the Auto Image menu.
2. Press the Next button once to display the available option.
3. Rotate the horizontal (◀▶) or vertical (⬆⬇) Adjust knob to select the window for which you want to perform Auto Image.
4. Press Next again to perform the Auto Image.
5. If desired, repeat steps 3 and 4 for any other windows for which you want to perform an automatic image adjustment.
6. When finished with Auto Image, do one of the following:
 - Select NA and press Next.
 - Press the Menu button.
 - Do nothing and wait for the menu to time out.

Input Configuration menu

The Input Configuration menu allows you to select a video signal type for each of the four fully configurable inputs. All of these inputs can accept the following video signals: RGB, YUV-HD, YUVi, RGBcvS, S-video, composite video, DVI (MGP 464 DI and MGP 464 HD-SDI only), and HD-SDI (MGP 464 HD-SDI only); RGB is the default. You can also select the horizontal and vertical start positions, pixel sampling phase for the four windows (except for YUVi, S-video, and composite video inputs), total pixels, active pixels, and active lines for each input. Rotate the horizontal Adjust (◀▶) knob to cycle through the four inputs, and the vertical Adjust knob (⬆⬇) to adjust the setting.

NOTE *The 15 virtual inputs (numbered 5 through 19) cannot be configured from the front panel; you must use SIS commands, the Windows-based control software, or the MGP 464 Web pages.*

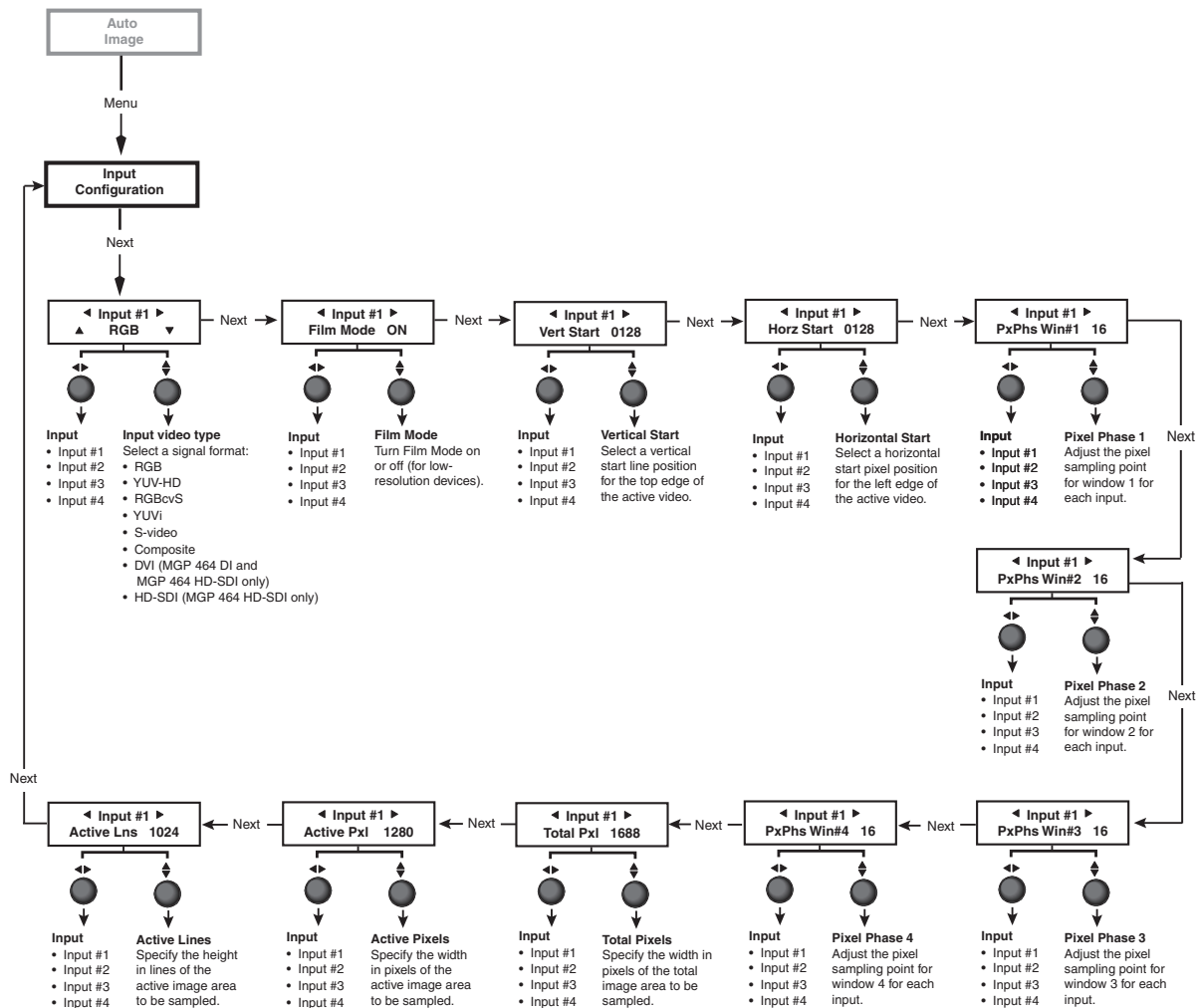

Input Configuration menu flow

Operation, cont'd

Input configuration submenu adjustments

The table below shows how to make the selections and adjustments that are accessed through the Input Configuration submenus.

Input Configuration submenu	Horizontal Knob Adjustment	Vertical Knob Adjustment
<p>Video type The following video signal types are accepted:</p> <p>RGB S-video YUV-HD Composite video YUVi DVI (MGP 464 DI and MGP 464 HD-SDI only) RGBcvS HD-SDI (MGP 464 HD-SDI only)</p>	Select input #1, 2, 3, or 4.	Select the desired video format for the displayed input. Default: RGB
<p>Film mode For low resolution inputs. The video signal type for the input you are configuring must be set to YUVi, composite video, or S-video in order to place the input in film mode.</p>	Select input #1, 2, 3, or 4. Shows the current film mode status for the displayed input: On, Off, or na (not applicable).	Select On or Off to turn 3:2 or 2:2 pulldown (film mode) on and off for the selected input.
<p>Vertical start position The distance in pixels from the top edge of the input's total video display area to the top edge of its active area</p>	Select input #1, 2, 3, or 4. Shows the current vertical start point for the displayed input.	Increase or decrease the distance in pixels from the top edge of the video display's total area to the top edge of its active area. Default is 128 .
<p>Horizontal start position The distance in pixels from the left edge of the input's total video display area to the left edge of its active area</p>	Select input #1, 2, 3, or 4. Shows the current horizontal start point for the displayed input.	Increase or decrease the distance in pixels from the left edge of the video display's total area to the left edge of its active area. Default is 128 .
<p>Pixel phase 1 The point at which pixels are sampled for window 1. (The values cannot be changed when the input is DVI, YUVi, S-video, or composite video.)</p>	Select input #1, 2, 3, or 4 for window 1.	Increase or decrease the displayed value to move the pixel sampling point for window 1 to an optimal sampling point that ensures output clarity. The range of settings is 0-31 ; default is 16 .
<p>Pixel phase 2 The point at which pixels are sampled for window 2. (The values cannot be changed when the input is DVI, YUVi, S-video, or composite video.)</p>	Select input #1, 2, 3, or 4 for window 2.	Increase or decrease the displayed value to move the pixel sampling point for window 2 to an optimal sampling point that ensures output clarity. The range of settings is 0-31 ; default is 16 .

Input Configuration submenu	Horizontal Knob Adjustment	Vertical Knob Adjustment
Pixel phase 3 The point at which pixels are sampled for window 3. (The values cannot be changed for DVI, YUVi, S-video, or composite video inputs.)	Select input #1, 2, 3, or 4 for window 3.	Increase or decrease the displayed value to move the pixel sampling point for window 3 to an optimal sampling point that ensures output clarity. The range of settings is 0-31; default is 16.
Pixel phase 4 The point at which pixels are sampled for window 4. (The values cannot be changed for DVI, YUVi, S-video, or composite video inputs.)	Select input #1, 2, 3, or 4 for window 4.	Increase or decrease the displayed value to move the pixel sampling point for window 4 to an optimal sampling point that ensures output clarity. The range of settings is 0-31; default is 16.
Total pixels The width in pixels of the total video display area. (The values cannot be changed for DVI, YUVi, S-video, or composite video inputs.)	Select input #1, 2, 3, or 4.	Increase or decrease the width in pixels of the total video display area of the selected input. Default is marked with an asterisk (*).
Active pixels The width in pixels of the active video area	Select input #1, 2, 3, or 4.	Increase or decrease the width in pixels of the active video area of the selected input. Default is marked with an asterisk (*).
Active lines The height in lines of the active video area	Select input #1, 2, 3, or 4.	Increase or decrease the height in lines of the active video area of the selected input. Default is marked with an asterisk (*).

Output Configuration menu

The Output Configuration menu allows you to set output resolution, refresh rate, output signal type, and sync polarity. The following flow diagram shows the Output Configuration submenus and the adjustments that can be made from them.

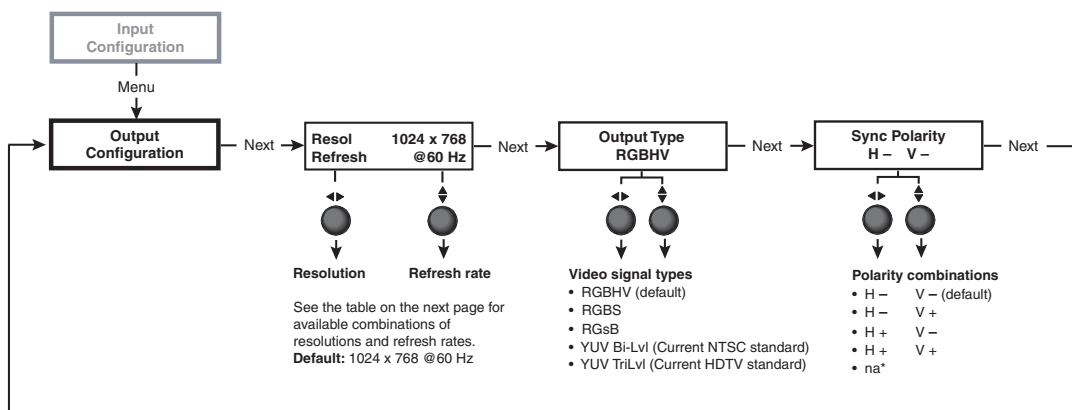

*Appears when YUV bi-level or tri-level is selected.

Output Configuration menu flow

NOTE The menu time out and the default cycle displays after 20 seconds of inactivity; however, any selections you made with the Adjust knobs are saved and remain in effect.

Operation, cont'd

Resolution and Refresh Rate submenu

While this submenu is displayed, rotate the horizontal Adjust (◀▶) knob to select one of the available resolutions, or rotate the vertical Adjust (⬇️) knob to select one of the available refresh rates. The resolutions and refresh rates are listed in the following table.

Resolution	Refresh Rates					
	50 Hz	60 Hz	72 Hz	96 Hz	100 Hz	120 Hz
640 x 480	X	X	X	X	X	X
800 x 600	X	X	X	X	X	X
852 x 480	X	X	X	X	X	
1024 x 768	X	X	X	X		
1024 x 852	X	X	X	X		
1024 x 1024	X	X	X			
1280 x 768	X	X				
1280 x 1024	X	X				
1360 x 765	X	X				
1365 x 768	X	X				
1366 x 768	X	X				
1365 x 1024	X	X				
1400 x 1050	X	X				
1600 x 1200	X	X				
480p		X				
576p	X					
720p	X	X				
1080i	X	X				
1080p	X	X				
DVI BCKGD* RATE	Resolution and clock of the incoming background input					

* When DVI BCKGD is selected as the output resolution/rate, the MGP uses the incoming DVI background input resolution and clock as the output rate. The sync type and polarity options are available for the RGB output while the background timings are used. If available, the output of the MGP is locked to the DVI background rate until you select a different resolution or disconnect the DVI background input.

By default, the resolution provided in the Extended Display Identification Data (EDID) is the last selected factory rate. To manually set the resolution information provided in the EDID data, see the Set EDID information SIS command on page 4-9.

Output Type submenu

Rotate either the horizontal Adjust (◀▶) or the vertical Adjust (⬇️) knob to select the output signal type required by the display device. Available signal types are RGBHV, RGBS, YUV bi-level and YUV tri-level. The default is RGBHV.

Sync Polarity submenu

The display device may require a particular combination of horizontal (H) and vertical (V) sync signal polarities. Rotate either the horizontal Adjust (◀▶) or the vertical Adjust (⬆⬇) knob to select the sync polarity. The options are H-V-, H+V-, H-V+, H+V+, or NA (appears when YUV Bi-lvl or YUV TriLvl is selected). The default is H-V-.

Window Configuration menu

The Window Configuration menu allows you to set window front/back priority, add colored borders to the windows, select which window transition effect to use when muting (closing) and unmuting (displaying) a window, and specify the duration of the selected effect.

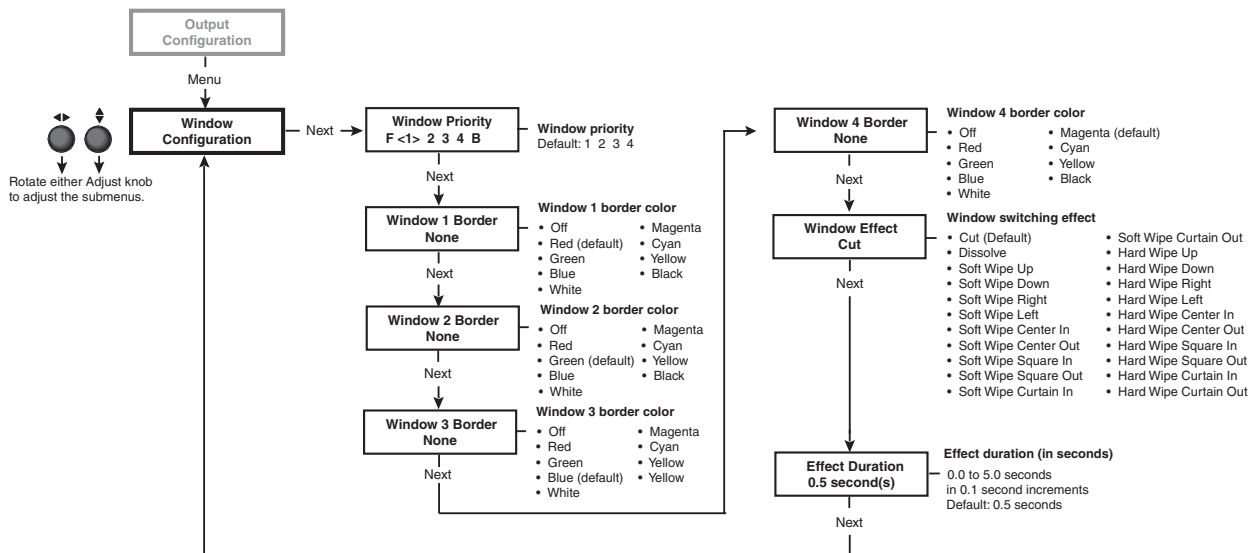

Window Configuration menu flow

NOTE The menu time out and return to the default cycle after 20 seconds of inactivity; however, any selections you made with the Adjust knobs are saved and remain in effect.

Window Priority submenu

The Window Priority submenu allows you to set how the windows will overlap one another or “stack” on the display. For example, the window with priority 1 is displayed in front of all the other windows. If the top priority window is sized to fill the screen, the other windows are not visible.

By default, the Window Priority submenu displays the numbers of the four windows in order, from left to right, with window 1 having first priority. To change a window’s priority,

1. Select a window by rotating the vertical Adjust (⬆⬇) knob to move the angle brackets on the LCD screen to the number of the window whose priority level you want to change.
2. Rotate the horizontal Adjust (◀▶) knob to move the bracketed window number to the desired priority position. For example, if you want window 3 to display in front of all the other windows (priority 1), move <3> all the way to the left, following the letter F on the LCD screen.
3. Repeat steps 1 and 2 as desired for each additional window whose priority you want to change.

Operation, cont'd

Window Border submenus

Use these submenus (one for each window) to select colored borders for the four windows. Turn either Adjust knob to display the available options: Red, Green, Blue, White, Magenta, Cyan, Yellow, and Black. You can also select Off, which specifies no border. The defaults are Red for window 1, Green for window 2, Blue for window 3, and Magenta for window 4.

Window Effect submenu

Use this submenu to select a transition effect for the MGP 464 to use when muting and unmuting windows. To select a transition effect,

1. Press the Menu button repeatedly until Window Configuration is displayed on the LCD screen.
2. Press the Next button repeatedly until Window Effect is displayed.
3. Rotate either the horizontal Adjust (◀▶) or the vertical Adjust knob (⬆⬇) to select a transition effect.

Available effects

Cut — A cut instantly mutes or unmutes the window. The effect duration does not apply.

Dissolve — A dissolve causes the window to fade in or out.

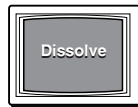

Standard wipe — A standard wipe causes the new window to appear to unroll over the other one. The new window can roll from the top, bottom, left, or right.

A standard wipe can have a soft (fuzzy) or a hard (sharp) leading edge.

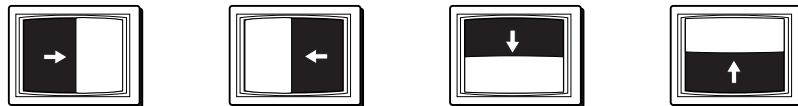

Center wipe — A center wipe causes the new window to appear to unroll over the other one in one of two ways:

- In from the top and bottom edges to the center of the window
- Out from the center to the top and bottom edges of the window

A center wipe can have a soft (fuzzy) or a hard (sharp) leading edge.



Square wipe — A square wipe causes the new window to appear to unroll over the other one in one of two ways:

- In from the top, bottom, right, and left edges to the center of the window
- Out from the center to the four edges of the window

This effect creates a square shaped transition.

A square wipe can have a soft (fuzzy) or a hard (sharp) leading edge.



Curtain wipe — A curtain wipe causes the new window to appear to unroll over the other one in one of two ways:

- In from the left and right edges to the center of the window
- Out from the center to the right and left edges of the window

A curtain wipe can have a soft (fuzzy) or a hard (sharp) leading edge.



Effect Duration submenu

Use this submenu to set the amount of time the MGP 464 takes to complete a transition effect. Select from durations ranging from 0.0 to 5.0 seconds, in 0.1 second increments. (Duration is not available with the cut effect.)

To set an effect duration,

1. Press the Menu button repeatedly until Window Configuration is displayed on the LCD screen.
2. Press the Next button until Effect Duration is displayed.
3. Rotate either the horizontal Adjust (◀▶) or the vertical Adjust (⬆⬇) knob to select an effect duration.

Operation, cont'd

Background Capture menu

The Background Capture menu allows you to capture the image currently on the output screen and save it as a bitmap (.bmp) file with one of 16 designated image names. You can then recall the image and use it as a background.

Background Capture also can be done via the Windows-based control software (see chapter 4, "Software Configuration and Control") and the MGP 464 Web pages (see chapter 5, "HTML Configuration and Control").

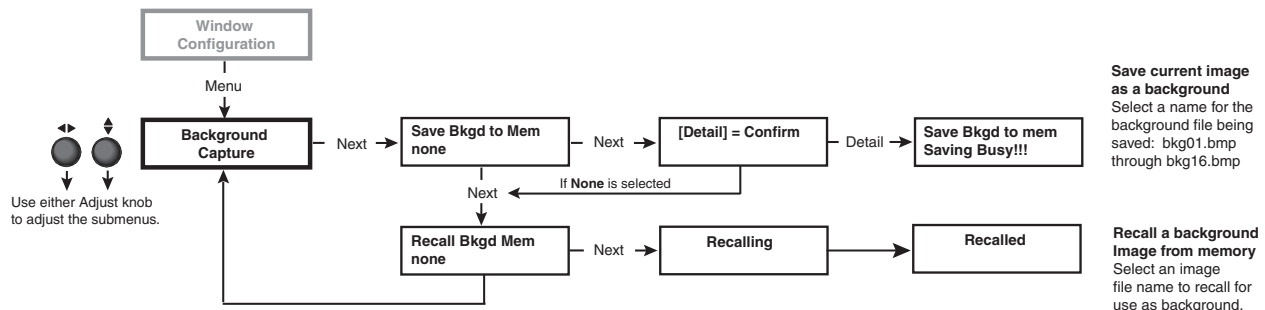

Background Capture menu flow

Memory space for background files

The MGP 464 has 16 MB of user storage space that can be used for saved backgrounds and uploaded user Web pages. The number of images that you can save depends on the size (in kB) of the image bitmap file and the resolution. The following table shows the number of images you can store based on resolution.

Resolution	640 x 480	800 x 600	1024 x 768	1280 x 1024	1400 x 1050	1600 x 1200	1080p
Image Size (kB)	900.00	1406.25	2304.00	3804.00	4306.64	5625.00	6075.00
Total Images	16	11	6	4	3	2	2

To calculate the size of a bitmap file for any image of any specified size, use this formula:

$$\text{file size (in kilobytes)} = (\text{horizontal} \times \text{vertical} \times 3) + 54 \text{ (file header ID)}$$

Saving a background to memory

To save the current image to memory for use as a background,

1. Press Menu repeatedly until the Background Capture screen is displayed.
2. Press Next repeatedly until the Save Background to Memory submenu screen is displayed.
3. Rotate either Adjust knob to select a background file name (bkg01.bmp through bkg16.bmp) with which to save the image.

NOTE You can save the background image only under one of the file names on this menu (you cannot make up a different name for it). However, images loaded via the Windows-based control software (IP Link File Manager) or via the MGP 464 Web pages may be given any desired file names. See chapter 4, "Software Configuration and Control," for information on using the Windows-based software, and chapter 5, "HTML Configuration and Control," for information on using the Web pages.

If you do not want to save the image, select None on the LCD screen, then press Next. The Recall Background submenu screen is displayed.

-
4. Press the Next button to save the image as a bitmap (.bmp) file. The LCD screen displays the message “[Detail] = Confirm.”

NOTE *The unit supports 24-bit bitmap files only. Their file names must have no more than 16 characters, including the .bmp extension.*

CAUTION *The image that you save overwrites any existing image file with the same file name.*

5. Press the Detail button (the top button located at the immediate left of the LCD screen).

The LCD screen displays the message “Save Background to Mem. Saving Busy!!!” The time the MGP takes to save an image varies depending on the image file size. For example, a 1024 by 768 pixel image takes about 150 seconds to save; a very large image combined with a high output resolution could take as long as 5 minutes.

After 20 seconds, the MGP displays the default cycle, but the Menu and Next buttons continue to blink until the image capture is complete.

NOTE *The unit continues to respond to commands while it is saving an image; however, the response time is longer. It is not recommended that you attempt to save or recall another background image during this process.*

6. If you want to recall a background file for the output display, press Next within 20 seconds.

Recalling a background from memory

To recall an image from memory for use as a background,

1. Press Menu repeatedly until the Background Capture screen is displayed.
2. Press Next repeatedly until the Recall Background from Memory submenu screen is displayed.
3. Rotate either Adjust knob to select one of background image files to recall for use as the output background.

To perform no action, press the Menu button.

4. Press the Next button to recall the image. The LCD screen displays the message “Recalling” while the image is being recalled, then “Recalled” after the recall is complete.

Comm./IP Configuration menu

Use the Comm./IP Configuration menu to view and edit the serial communication port configuration and the MGP’s IP addresses. The Comm./IP Configuration menu consists of two levels: view and edit.

Viewing serial port and IP settings

When you first reach the Comm./IP Configuration menu, you are on view level; that is, all the screens that you cycle through by pressing Next show the current settings. You cannot make changes from them. To view the serial port and IP settings,

1. Press Menu repeatedly until the Comm./IP Configuration menu is displayed.
2. Press Next repeatedly to cycle through the screens displaying the current settings for the serial port, MAC address, DHCP mode, IP address, Gateway address, and Subnet mask.
3. Press Menu to return to the Comm./IP Configuration screen.

Operation, cont'd

Making changes to the serial port and IP configuration

To make changes to the serial port configuration, IP address, DHCP mode, Gateway address, and/or Subnet mask, you must access the edit level screens as follows:

1. With any Comm./IP Configuration menu view-level screen displayed, press the Enter button and hold it until the Serial Config screen appears (approximately 2 seconds).
2. Press Next repeatedly to cycle through the edit level screens.
3. To enter or change information on each screen, rotate the horizontal Adjust knob (◀▶) to move the angle brackets to the desired setting. Rotate the vertical Adjust knob (⬆⬇) to adjust the setting.
4. When finished editing the settings for the selected item, either press Next to go to the editing screen for the next item, or press Menu to exit serial/IP edit mode and go to the next menu (Advanced Configuration).

Screens are provided for editing the following parameters:

- **Serial Config:** Configure the serial port by switching between RS-232 and RS-422, and selecting the baud rate.
- **Set DHCP Mode:** Set DHCP to On or Off.

NOTE DHCP must be off before you can edit the IP addresses.

- **Set IP Address:** Set the IP address.
- **Set Gateway Addr:** Set the gateway address.
- **Set Subnet Mask:** Set the subnet mask.

NOTE You cannot edit the MAC address; there is no editing screen for it.

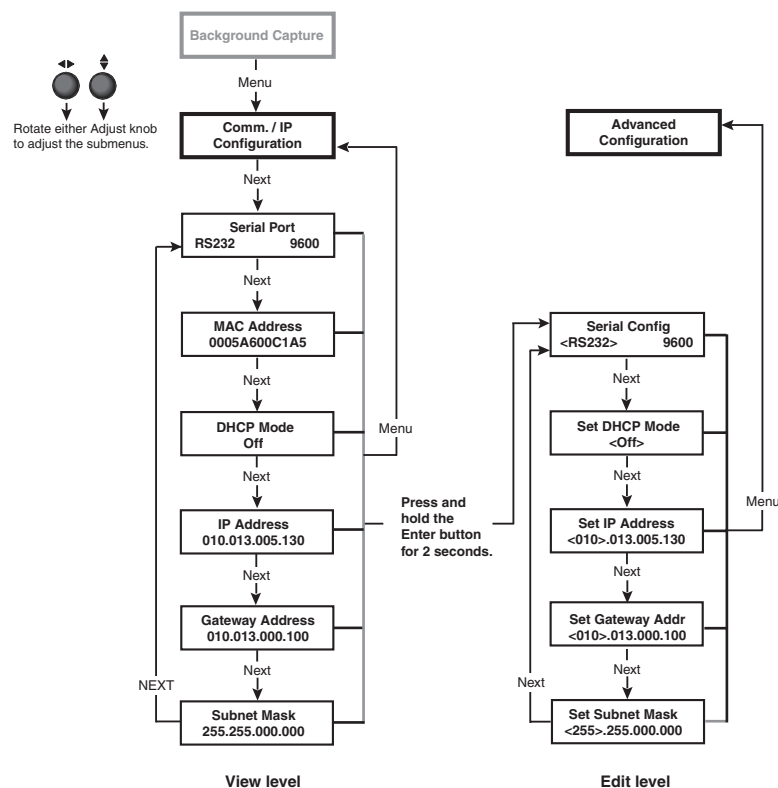

Communication/IP Configuration menu flow

Advanced Configuration menu

Use the Advanced Configuration menu to set the background color, turn blue mode on and off, and select test patterns. You can also view the MGP's internal temperature and reset the system to its factory default settings.

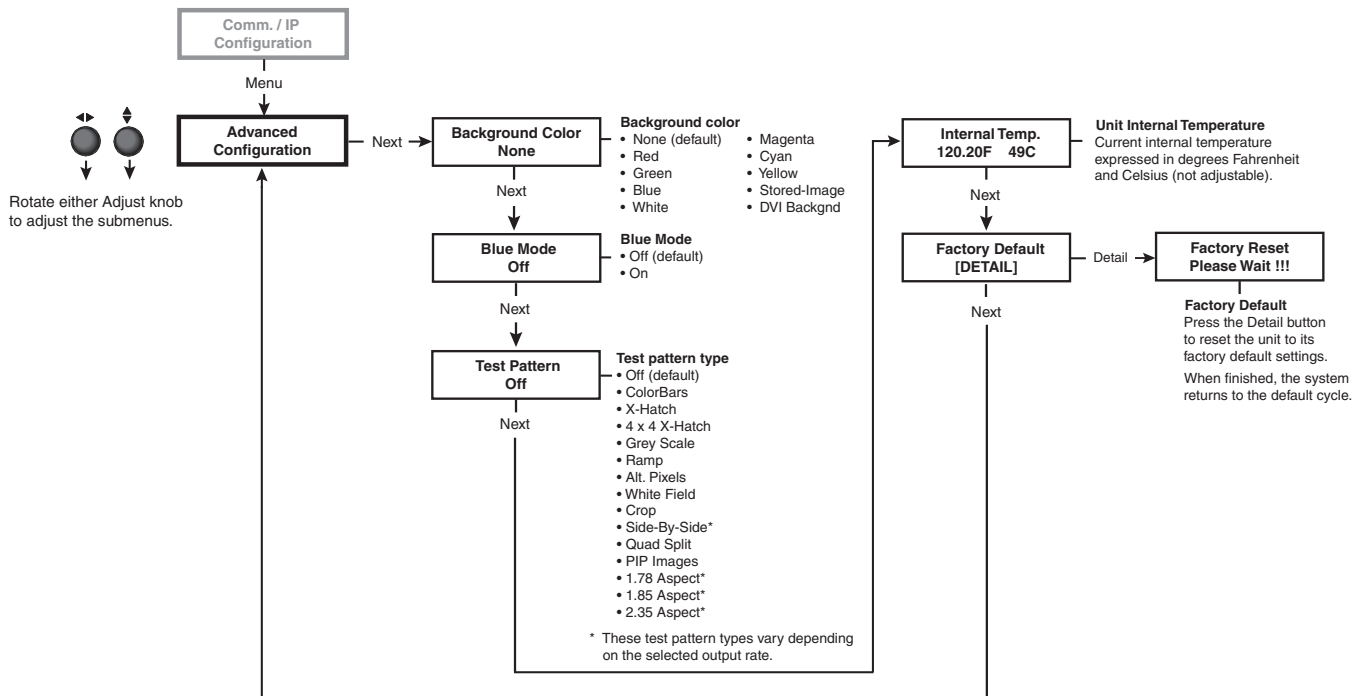

Advanced Configuration menu flow

Background Color submenu

Rotate either Adjust knob to select a background color for the output screen. Options are None, Red, Green, Blue, White, Magenta, Cyan, Yellow, Stored-Image, and DVI Background.

- **None**, the default setting, produces a black background.
- **Stored-Image** is the saved background that was most recently recalled. Select this option if you want to return to the recalled background after having changed to a different background color.
- **DVI Backgnd** displays the unscaled image from the DVI Background input as the background on the screen. When this option is selected, the MGP changes the output rate to match that of the DVI Background source.

The output rate remains set to the DVI Background rate until the rate is manually switched back to the factory default resolution. This provides clean transitions between the DVI Background and stored images or background colors.

Blue Mode submenu

Blue mode causes only sync and blue video signals to be passed to the display. This can aid in the setup of the color and tint of video inputs on the MGP. While the blue mode submenu is displayed, rotate either Adjust knob to turn blue mode on and off.

Operation, cont'd

Test Pattern submenu

Several test patterns are available via this submenu to adjust the display device for color, convergence, focus, resolution, contrast, grayscale, and aspect ratio. Use either Adjust knob to select a test pattern. The available patterns are:

- Colorbars (8 color bars)
- X-Hatch (16 x 12 crosshatch)
- 4x4 X-Hatch (4 x 4 crosshatch)
- Grey Scale (grayscale)
- Ramp
- Alt. Pixels (alternating pixels)
- White Field
- Crop
- Side-By-Side (4 x 3 or 16 x 9 side by side crop)
- Quad Split (4 x 4 quad split crop)
- PIP Images (4 x 3 picture-in-picture images)
- 1.78 Aspect (film aspect ratio 1.78)
- 1.85 Aspect (film aspect ratio 1.85)
- 2.35 Aspect (film aspect ratio 2.35)

The default setting is Off.

Some of the test patterns available from the submenu vary depending on the selected output rate. For example, if a 4 x 3 output rate is selected, the 4 x 3 side-by-side crop and aspect ratio patterns appear. If a 16 x 9 output rate is selected, the 16 x 9 side-by-side crop and aspect ratio patterns appear.

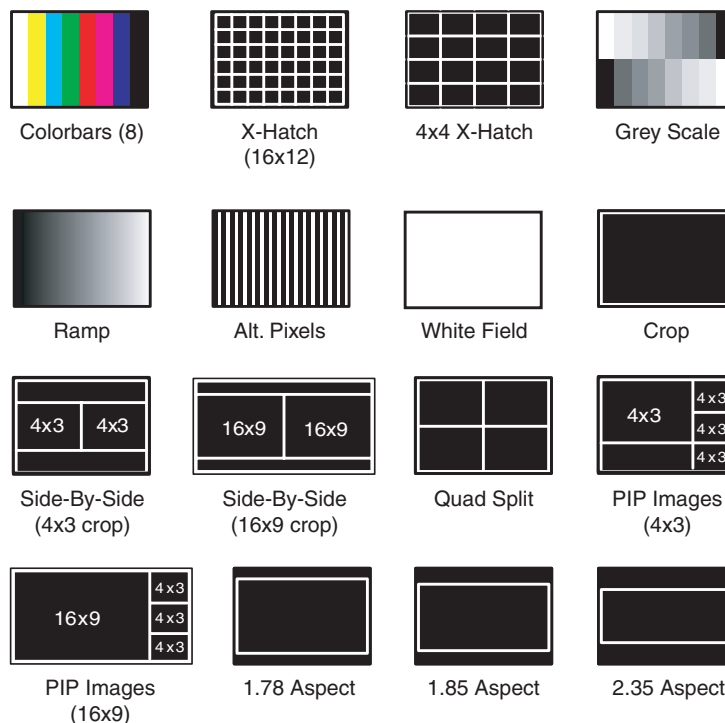

Test patterns available for the MGP 464

Internal Temperature screen

The Internal Temp submenu displays the unit's current internal temperature. The MGP 464 displays the temperature in degrees Fahrenheit and Celsius. This is an information-only screen; no adjustments can be made on it.

Factory Default submenu

This submenu lets you reset the MGP 464 to the default settings with which it was delivered from the factory. Press the Detail button to initiate the reset.

Adding and Configuring Window Text

You can add a text box or label, containing up to 16 characters, to each window. You can also specify several parameters for the text label, including text size and color, label background color, label border color, and the position of the text box on the screen.

These window text specifications cannot be made from the front panel. You can create and configure the label using the Windows-based control software or SIS commands via the RS-232/422 rear panel port (see chapter 4, "Software Configuration and Control"), or using the MGP 464 Web pages (see chapter 5, "HTML Configuration and Control").

Picture Controls

The MGP 464 has six picture control buttons located on the front panel to the left of the menu button. You can use these buttons to adjust size, position, brightness and contrast, color and tint, detail, and magnification (zoom). See the Picture Controls table on the next page for an explanation of these buttons' functions.

NOTE *Picture controls are window-dependent. You set the values separately for each window.*

NOTE *For Window/Image Size, Window/Image Position, and Window Image Zoom, pressing the button repeatedly switches back and forth between window settings and image settings.*

Adjusting the picture controls

Make image adjustments to an input by using the picture control buttons on the front panel. When you select one of these buttons, the button for the most recently selected window lights, indicating that the window is being adjusted.

To adjust the picture controls,

1. Press the Window Select button to select the window you want to adjust.
2. Press the Input button for the input that you want to adjust, if it is not currently selected.
3. Press the button for the desired picture control: Window/Image Size (sizing), Bright/Cont (brightness and contrast), Detail (sharpness), Window/Image Position (moving and centering), Color/Tint (color quality), or Window/Image Zoom (magnification).
4. Rotate the horizontal Adjust (◀▶) and/or vertical Adjust (⬆⬇) knobs to select a level from the available range.
5. Repeat steps 1 through 4 for each image adjustment to be made for the selected input/window.

NOTE *The LCD screen may display "NA" in place of a number if that adjustment does not apply to the input's video format.*

Operation, cont'd

Picture Controls table

The following table explains the functions of the Picture Control buttons and how to make adjustments. (In the Display column, *n* stands for a single digit, 0 through 9.)

Button	Display	Function	Range	Adjust Knob
Window/ Image Size	WINDOW <i>n</i> SIZE: H= <i>nnnn</i> V= <i>nnnn</i>	Enlarge or shrink window 1, 2, 3, or 4.	Min: 1/16 of the output rate Max: Output rate	For H (width): horizontal ◀▶ Adjust knob
	(Press button twice.) IMAGE # <i>nn</i> SIZE: H= <i>nnnn</i> V= <i>nnnn</i>	Enlarge or shrink the image within the window.	Min: 1/16 of the output rate Max: 2 times the output rate	For V (height): vertical ⬆ Adjust knob
Bright/Cont	BRIT <i>nnnn</i> CONT <i>nnnn</i>	Brightness: Increase or decrease intensity of video light on screen. Contrast: Increase or decrease range of image light and dark values.	Brightness: 000-127 Default: 064 Contrast: 000-127 Default: 064	Bright: horizontal ◀▶ Adjust knob Contrast: vertical ⬆ Adjust knob
Detail	DETAIL <i>nnnn</i>	Adjust image sharpness.	000 - 127 Default: 064	Either
Window/ Image Position	WINDOW <i>n</i> CNTR: H= <i>±nnnn</i> V= <i>±nnnn</i>	Position window 1, 2, 3, or 4 on the output screen in relation to center.	Default: 0000 ± the output rate	For H: horizontal ◀▶ Adjust knob
	(Press button twice.) IMAGE # <i>nn</i> START: H= <i>±nnnn</i> V= <i>±nnnn</i>	Position the image within the window in relation to the window center.	Default: 0000 ± the output rate	For V: vertical ⬆ Adjust knob
Color/Tint	COLOR <i>nnnn</i> TINT <i>nnnn</i>	Color: Adjust color intensity. (At the lowest adjustment, all colors are shades of gray.) Tint: Change the appearance of colors.	Color: 000 - 127 Default: 064 Tint: 000 - 127 Default: 064	Color: horizontal ◀▶ Adjust knob Tint: vertical ⬆ Adjust knob
Window/ Image Zoom	WINDOW <i>n</i> ZOOM: H= <i>nnnn</i> V= <i>nnnn</i>	Increase/decrease the size of the selected window while keeping the aspect ratio constant.	Min: 1/16 of the output rate Max: Output rate	For H: horizontal ◀▶ Adjust knob
	(Press button twice.) IMAGE # <i>nn</i> ZOOM: H= <i>nnnn</i> V= <i>nnnn</i>	Increase/decrease the size of the image in the selected window while keeping the aspect ratio constant.	Min: 1/16 of the output rate Max: 2 times the output rate	For V: vertical ⬆ Adjust knob

Auto Memories

Whenever changes are made to the settings described in the previous pages, the MGP automatically saves the changes in memory. These settings are saved based on the input frequency and are later recalled when the identical resolution is applied to the configured input. These memory locations are separate from the input presets.

The following settings are saved by the auto memory feature:

Pixel phase	Percentage of window filled*
Total pixels	Brightness
Active pixels	Contrast
Active lines	Color
Vertical start	Tint
Horizontal start	Detail

*Image size and position are saved as a percent of the window, so that the auto memory can be used for any size window.

Memory Presets

A preset is a set of window or input parameters that you create and save as a file in MGP memory. You can recall a saved preset and implement its settings at any time. A preset enables you to save time by applying a group of settings to your MGP at one time.

Window presets

The MGP 464 allows up to 128 window presets that save information for all the windows. Use the Preset Save/Recall and Enter buttons on the front panel to save and recall presets. Window presets can also be saved, recalled, and named using the Windows-based control software or SIS commands via the RS-232/422 interface or an Ethernet connection (see chapter 4, "Software Configuration and Control"), or by accessing the product Web pages using an Ethernet connection (see chapter 5, "HTML Configuration and Control").

The following settings can be saved in a window preset:

Window border color	Background setting
Window priority	Window size/position
Window mute status	Image size/position in the window
Label text color	Brightness
Label text size	Contrast
Label location	Color
Label border color	Tint
Label background color	Detail

Saving a window preset

To save a window preset using the front panel buttons,

1. Set the parameters listed above as desired for windows 1, 2, 3, and 4.
2. Press and hold the Preset Recall/Save button for at least 2 seconds. The LCD screen displays the following:

WINDOW PRESET
Save To #001

3. Rotate either Adjust knob to select one of the 128 available window preset locations in which to save the settings.

Operation, cont'd

4. Press the Enter button to save the current window setting in the preset location that you selected. The LCD screen shows a message indicating that the preset is being saved to the selected memory location, followed by a message that the preset has been saved.

The following examples show a preset saved to memory location 1.

```
WINDOW PRESET
Saving To #001
```

```
WINDOW PRESET
#001 SAVED
```

If you want to exit this menu without saving any changes, repeatedly press the Preset Recall/Save button until the following message appears on the LCD screen, then press the Enter button to exit the Window Presets dialog.

```
WINDOW PRESET
[ENTER] TO EXIT
```

Recalling a window preset

To recall a window preset using the front panel buttons,

1. Press and release the Preset Recall/Save button. The following message appears on the LCD screen:

```
WINDOW PRESET
Recall #001 woINP
```

2. If you do not want to recall the input whose number was displayed when the preset was saved, proceed to step 3.

If you want to recall the input with the preset, press the Preset Recall/Save button again. The following message appears:

```
WINDOW PRESET
Recall #001 wINP
```

If you select this option, the inputs change to display the sources that were displayed at the time the preset was saved.

3. Use either Adjust knob to select a window preset number to recall.
4. Press the Enter button to recall the preset you selected. The LCD screen shows a message indicating that the preset was recalled. The following example shows a message indicating that preset 1 was recalled.

```
WINDOW PRESET
#001 RECALLED
```

If you want to exit this menu without recalling a preset, repeatedly press the Preset Recall/Save button until you see the "Window Preset [Enter] to Exit" message. Press the Enter button to exit the Window Presets dialog.

Default presets

The following figure shows the factory default preset window configurations. These presets can be used for any output rate. If you overwrite them, you can recover them by selecting Factory Defaults from the Advanced Configuration menu. (See "Advanced Configuration menu," earlier in this chapter.)

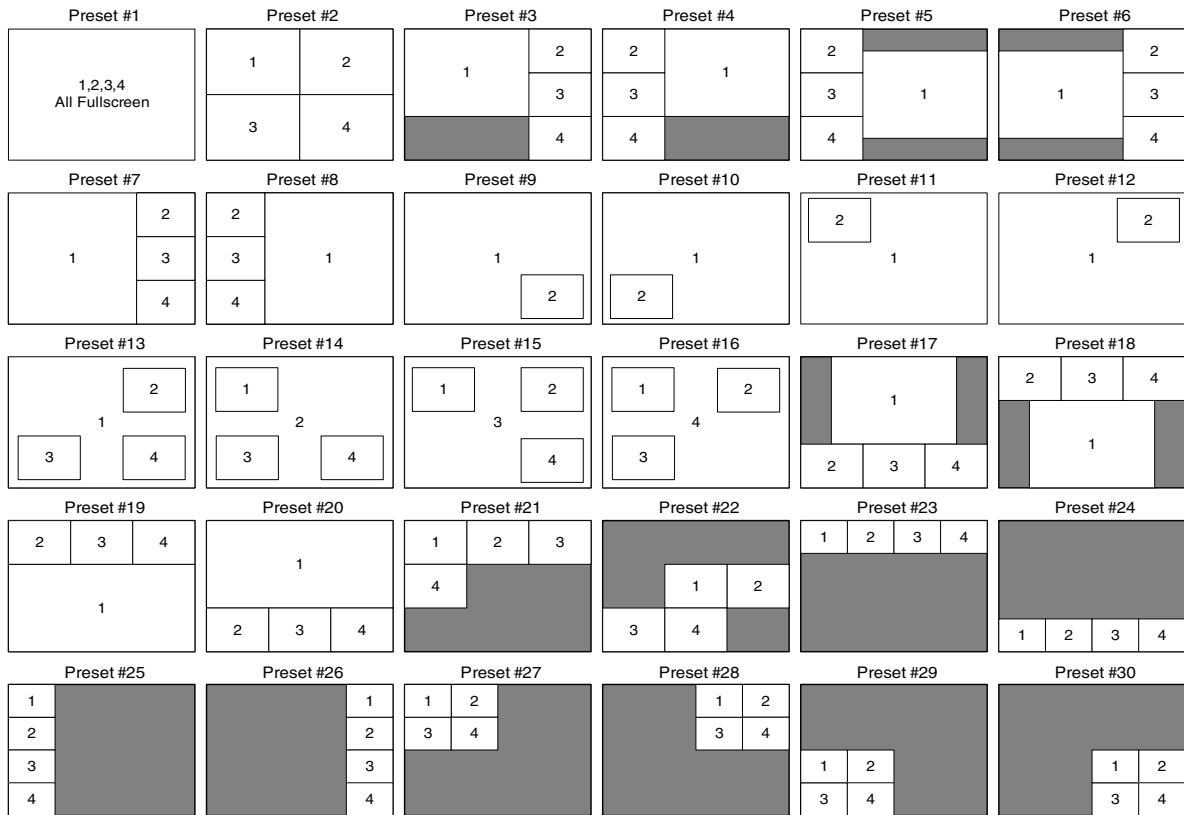

Factory default preset configurations

Input presets

The MGP 464 has 128 input preset slots, which can save signal type, input configuration settings, picture control settings, and window text for any of the inputs. These presets can be saved and recalled using the Windows-based control software, SIS commands, or the MGP 464 Web pages (see chapter 4, "Software Configuration and Control," and chapter 5, "HTML Configuration and Control," for further information).

The following settings are contained in the input presets:

Input Type	Horizontal Start	Total Pixels
Input Name	Vertical Start	Active Pixels
Film Mode On/Off	Pixel Phase	Active Lines
Brightness	Contrast	Color
Tint	Detail (sharpness)	Percentage of window filled*

*Image size and position are saved as a percent of the window, so that the input preset can be used for any size window.

Operation, cont'd

NOTE *The 128 input presets are global, containing all of the settings for an input when the MGP is used with a matrix switcher. This allows a matrix switcher with multiple types of video inputs to be connected to the MGP 464 to expand the number of input video sources.*

Each input should be switched into the MGP, configured (window/image sizing, position, color, tint, brightness, contrast, and text label), then saved as a preset for recall by the control system when that input is sent from the switcher to any of the four MGP inputs.

Additional Features

Freeze mode

The front panel Freeze button is the first button on the left. Press this button to freeze the current image in the currently selected window. You can also freeze the windows using the Windows-based control software or SIS commands via an RS-232 or RS-422 connection.

If you switch inputs while a window is frozen, the freeze mode is cancelled and the new input's image appears in the window.

Locking the front panel (executive mode)

To prevent access by unauthorized users or accidental changes to the MGP 464's settings, some of the front panel controls can be locked using executive mode. When you place the MGP in executive mode via the front panel, the picture control buttons and the menu selection buttons are locked. All other functions (input and window selection, freezing, and preset saving and recalling) remain accessible. The rear panel RS-232/422, front panel Config, and LAN ports also remain unlocked.

You can enable or disable executive mode when the system is in the default cycle. To turn executive mode on and off, press the Window/Image Size and the Window/Image Position buttons simultaneously, and hold them for at least 2 seconds. The default is Disabled.

You can also enable and disable executive mode by using the SIS commands or the Windows-based control software via the serial or LAN ports (see chapter 4, "Software Configuration and Control," for more information).

NOTE *If you place the MGP in executive mode by using SIS commands or the Windows-based control software, you have an additional type of executive mode available. In executive 2 mode, all the front panel controls are locked. This mode is available only through SIS commands. See chapter 4, "Software Configuration and Control," for information on SIS commands, or the control software's help program.*

Resetting

Resetting the unit causes various IP functions and Ethernet connection settings to revert to factory defaults. There are four reset modes (numbered 1, 3, 4, and 5 for the sake of comparison with Extron IP Link products) that are available by pressing the Reset button on the rear panel. The Reset button is recessed, so you must use a pointed stylus, ballpoint pen, or small screwdriver to press it. See the table on the next page for a summary of the reset modes.

CAUTION *Review the reset modes carefully. Using the wrong reset mode may result in unintended loss of flash memory programming, port reassignment, or processor reboot.*

Reset Mode Comparison/Summary

Mode	Activation	Result	Purpose/Notes
1	Hold in the recessed Reset button (located next to the LAN connector) while applying power to the unit.	Mode 1 causes the MGP to revert to the factory default firmware. Event scripting does not start if the unit is powered on in this mode. All user files and settings are maintained.	Use mode 1 to remove a version of firmware if incompatibility issues arise.
3	Hold in the Reset button for 3 seconds, until the Reset LED blinks once. Then, within 1 second, press Reset again briefly (for less than 1 second).	Mode 3 turns events on or off. During resetting, the Reset LED flashes 2 times if events are starting; 3 times if events are stopping.	Events must be turned on if you want to change IP settings or scheduling.
4	Hold in the Reset button for 6 seconds, until the Reset LED has blinked twice: once at 3 seconds and once at 6 seconds. Then, within 1 second, press Reset briefly (for less than 1 second).	Mode 4 does the following: <ul style="list-style-type: none"> • Enables ARP capability. • Sets the IP address back to factory default. • Sets the subnet back to factory default. • Sets the default gateway address back to the factory default. • Sets port mapping back to factory default. • Turns DHCP off. • Turns all events off. The Reset LED flashes 4 times in quick succession during reset.	Mode 4 enables you to set IP address information using ARP and the MAC address.
5	Hold in the Reset button for 9 seconds, until the Reset LED has blinked three times: once at 3 seconds, once at 6 seconds, and once at 9 seconds. Then, within 1 second, press Reset briefly (for less than 1 second).	Mode 5 performs a complete reset to factory defaults (except the firmware). <ul style="list-style-type: none"> • Does everything mode 4 does. • Resets everything that was set via the Real Time Adjustments part of the control program: all video settings and miscellaneous options. • Resets all IP options. • Removes/clears all files from the processor. The Reset LED flashes 4 times in quick succession during the reset.	Mode 5 is useful if you want to start over with control software configuration and uploading, and to replace events.

NOTE *The reset modes listed in the table above close all open IP and Telnet connections and all sockets. Also, each mode is a separate function, not a continuation from mode 1 to mode 5.*

Operation, cont'd



MGP 464 Multi-Graphic Processor

4 Chapter Four

Software Configuration and Control

Setting Up RS-232/422 Communication

Using Simple Instruction Set (SIS) Commands

Windows®-based Control Software

Software Configuration and Control

The MGP 464 can be configured and controlled by software via the following interfaces:

- RS-232 or RS-422 (Simple Instruction Set [SIS™] commands or Windows®-based control software)
- LAN (Web pages, SIS commands, or Windows-based control software)

This chapter discusses the use of the SIS commands and how to access the Windows-based control software. For instructions on using the Windows-based control software, refer to the software's Help program. See chapter 5, "HTML Configuration and Control," for information on using the Web pages.

Setting Up Serial Communication

The MGP 464 has two serial communication ports: the RS-232/422 port, accessed via a 9-pin female D-sub connector on the rear panel, and the Config port, a 2.5 mm TRS connector on the front panel. These ports are used to connect to a host or external controlling device, such as a computer or control system, which can generate the proper command codes and recognize the processor's responses.

Connector pin assignments

The 9-pin RS-232/422 connector on the rear panel (see the illustration at right) has the following pin assignments:

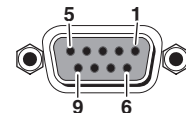

Pin	RS-232 function	Description
1	–	No connection
2	Tx	Transmit data
3	Rx	Receive data
4	–	No connection
5	Gnd	Signal ground
6	–	No connection
7	–	No connection
8	–	No connection
9	–	No connection

Pin	RS-422 function	Description
1	–	No connection
2	Tx-	Transmit ground
3	Rx-	Receive ground
4	–	No connection
5	Gnd	Signal ground
6	–	No connection
7	Rx+	Receive data
8	Tx+	Transmit data
9	–	No connection

The 2.5 mm TRS RS-232 connector on the front panel may be connected to a computer via the optional 9-pin D to 2.5 mm stereo mini TRS RS-232 cable (part #70-335-01). The pin assignments are shown below.

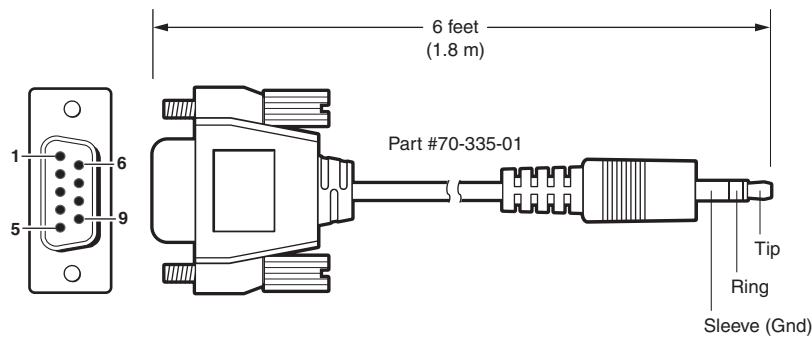

9-pin D	Connection	TRS Plug
Pin 2	Computer's RX line	Tip
Pin 3	Computer's TX line	Ring
Pin 5	Computer's signal ground	Sleeve

Front panel RS-232 configuration port pin assignments

NOTE *The cables used to connect the RS-232/422 port to a computer or control system may need to be modified by removing pins or cutting wires. If unneeded pins are connected, the processor may hang up.* **Communication software**

There are several programs that enable you to connect the MGP 464 to a computer or control device via the RS-232/422 interface, and to enter commands. HyperTerminal for Windows is one such program that is commonly used on PCs. In addition, the MGP has a Windows-based control software program, discussed later in this chapter, that is available through the RS-232/422 port, the front panel Config port, or via Ethernet. (See the MGP 464 software's help for information on using it to configure the MGP.)

For any program that you use, set up communication using the following protocol:

Baud rate: 9600
Data bits: 8
Parity: None
Stop Bits: 1
Flow Control: None

Using Simple Instruction Set (SIS) Commands

Host-to-MGP communications

The MGP 464 accepts SIS (Simple Instruction Set) commands through the RS-232/422 port on the rear panel, the RS-232 front panel Config port, and the LAN port. SIS commands consist of one or more characters per command field. They do not require any special characters to begin or end the command character sequence. Each response to a command ends with a carriage return and a line feed (↵), which signals the end of the response character string. A string is one or more characters.

MGP-initiated messages

When a local event such as a front panel selection or adjustment takes place, the MGP 464 responds by sending a message to the host. No response is required from the host. Examples of MGP-initiated messages are listed below (underlined).

(c) Copyright 2008, Extron Electronics, MGP464, Vx.xx 60-771-xx

The MGP 464 sends the copyright message when it is first powered on. Vx.xx is the firmware version number, and 60-771-01, 60-771-02, and 60-771-03 are the part numbers for MGP 464, MGP 464 DI, or MGP 464 HD-SDI, respectively.

Www, DD Mmm yyyy hh:mm:ss

The current date and time are displayed following the copyright message at power-up if the connection is via the Internet. (Www are the first three letters of the day of the week; e.g., Mon, Fri.)

Reconfig
Reconfig
Reconfig
Reconfig

The MGP sends a Reconfig message as each of the four windows is configured via the new connection.

Out *n* In *nn* (where Out *n* is the window number, and In *nn* is the input number).

The MGP sends this response when an input is switched.

Software Configuration and Control, cont'd

Error responses

When the MGP 464 receives a valid SIS command, it executes the command and sends a response to the host device. If the processor is unable to execute the command because the command is invalid or contains invalid parameters, it returns an error response to the host. The error response codes are:

- E01 — Invalid input channel number (too large)
- E09 — Invalid function number (too large)
- E10 — Invalid command
- E11 — Invalid preset number
- E12 — Invalid output number (applies for addressing windows)
- E13 — Invalid value (out of range)
- E14 — Invalid for this configuration
- E17 — Invalid command for signal type
- E24 — Privilege violation
- E26 — Maximum number of users connected has been exceeded
- E27 — Invalid event number
- E28 — Bad filename/File not found

Telnet and Web communications

The MGP 464 can also be controlled via an IP connection using either Telnet (port 23) or a Web browser (port 80). The ASCII and URL commands listed in the tables later in this chapter perform the same functions, but are encoded differently to accommodate the requirements of each port (Telnet or browser).

The ASCII to hexadecimal (hex) character conversion table below is for use with the Command/response table for SIS commands, beginning on page 4-9.

ASCII to HEX Conversion Table										Esc 1B	CR 0D	LF 0A			
20	!	21	"	22	#	23	\$	24	%	25	&	26	'	27	
(28)	29	*	2A	+	2B	,	2C	-	2D	.	2E	/	2F
0	30	1	31	2	32	3	33	4	34	5	35	6	36	7	37
8	38	9	39	:	3A	;	3B	<	3C	=	3D	>	3E	?	3F
@	40	A	41	B	42	C	43	D	44	E	45	F	46	G	47
H	48	I	49	J	4A	K	4B	L	4C	M	4D	N	4E	O	4F
P	50	Q	51	R	52	S	53	T	54	U	55	V	56	W	57
X	58	Y	59	Z	5A	[5B	\	5C]	5D	^	5E	_	5F
`	60	a	61	b	62	c	63	d	64	e	65	f	66	g	67
h	68	i	69	j	6A	k	6B	l	6C	m	6D	n	6E	o	6F
p	70	q	71	r	72	s	73	t	74	u	75	v	76	w	77
x	78	y	79	z	7A	{	7B		7C	}	7D	~	7E	DEL	7F

ASCII to hexadecimal character conversion table

The command/response tables list valid ASCII (for Telnet) command codes, the corresponding URL encoded (for Web browsers) command codes, the processor's responses to the host, and a description of the command's function or results from executing the command.

- Upper- and lowercase letters may be used interchangeably in the command field unless otherwise specified.
- Commands may be sent back-to-back without spaces; for example, 2*2!2*0B.
- Numbers can be entered as 1 digit, or as 2 or 3 digits with leading zeros; for example, 8V = 08V = 008V.

-
- There are a few differences in how to enter the commands depending on whether you are using Telnet or a Web browser.
 - For control via a Web browser, all non-alphanumeric characters must be represented as the hexadecimal equivalent, %xx, where xx represents the two-character hex byte. For example, a comma (,) would be represented as %2C.
 - When using these commands through a Web browser, the URL reference is used to shorten the examples. "URL" refers to the full URL of the control interface and Web page reference, including all path information; for example, http://192.168.100.10/myform.htm.
 - Some characters differ depending on what method you use to send the commands:

<u>Telnet</u>	<u>Web browser</u>
Escape (hex 1B)	W [must not be encoded]
Carriage return (hex 0D)	Pipe character () [must not be encoded]

NOTE *With Telnet you can use either the "Escape" commands or the "W" commands, and the carriage return or the pipe character. With the Web browser, you are required to use the "W" commands and the pipe character.*

In either method, the data string (shown in braces as {data} in the Command/response table) is directed to the specified port, and must be encoded if it is non-alphanumeric.

Software Configuration and Control, cont'd

Symbol definitions

- ↵ = CR/LF (carriage return/line feed) (hex 0D 0A)
- ← = Carriage return (no line feed) (hex 0D)
For Web browser commands, use the pipe character (|) instead of the soft return.
- = Space character
- | = Pipe (vertical bar) character
- Esc** = Escape key (hex 1B)
For Web browser commands, use **W** instead of **Esc**.)
- ^{24, 27, 28} = Superscripts indicate the error message displayed if the command is entered incorrectly or with invalid parameters. See "Error responses," earlier in this chapter.
- X1** = Specific port number (01-99)
The port number is represented as two ASCII characters (2 bytes). For example, port 05 would be represented as 30 35 in hexadecimal.
01 = RS-232/422 port (rear panel)
02 = Config port (front panel)
- X2** = Command data section
- NOTE** For Web encoding only:
Data is directed to the specified port and must be encoded if it is non-alphanumeric. Because data can include either command terminator, it must be encoded as follows when used within the data section:
Space (Hex 20) must be encoded as %20 (hex 25 32 30)
Plus sign (Hex 2B) must be encoded as %2B (hex 25 32 42).
- X3** = Greenwich Mean Time (GMT) offset value (-12:00 to 14:00) in hours and minutes (hh:mm)
- X5** = On/Off
0 = off/disable
1 = on/enable
- X11** = Version number (listed to two decimal places)
- X12** = Unit name is a text string of up to 24 characters drawn from the alphabet (A-Z), digits (0-9), and the minus sign/hyphen (-). The first character must be an alpha character. The last character must not be a minus. No blank or space characters are permitted, and no distinction is made between upper- and lowercase.
- X13** = Local date and time format
Set format (MM/DD/YY-HH:MM:SS); e.g., 06/21/02-10:54:00
Read format (day of week, day month year) (HH:MM:SS), e.g., Fri, 26 Sep 2008 18:19:33
- X14** = IP address (xxx.xxx.xxx.xxx); leading zeros in each of four fields are optional in setting values, and are suppressed in returned values.
- X15** = Mail domain name (e.g., Extron.com)
- X17** = Time in tens of milliseconds to wait for the response via the serial port
Default = 10 (100 ms)
Maximum = 32767
- X18** = Hardware (MAC) address (xx-xx-xx-xx-xx-xx)
- X19** = Subnet mask (xxx.xxx.xxx.xxx). Leading zeros are optional in setting values in each of four fields, and are suppressed in returned values.
- X20** = Time in tens of milliseconds to wait between characters received via the serial port
Default = 20 (200 ms)
Maximum = 32767
- X21** = Message length, delimiter value, or byte count (via the serial port)
#L = Length of message to be received
#D = Delimiter value
= byte count (1 through 32767; default = 0)
- X22** = Verbose response mode
0 = clear/none
1 = verbose mode
2 = tagged responses for queries
3 = verbose mode and tagged responses for queries
Default = 0 for Telnet connections; 1 for RS-232/422 control.
- NOTE** If tagged responses are enabled, all read commands return the constant string plus the data.
Example:
Command: **Esc** CN ↵
Response: Ipnr • **X12** ↵
- X25** = Baud rate: 300, 600, 1200, 1800, 2400, 3600, 4800, 7200, 9600, 14400, 19200, 28800, 38400, 57600, or 115200
- X26** = Parity (only the first letter is needed):
Odd
Even
None
Mark
Space
- X27** = Data bits: 7 or 8
- X28** = Stop bits: 1 or 2
- X29** = Port type
0 = RS-232
1 = RS-422
- X30** = Flow control
H = hardware
S = software
N = none
- X31** = Data pacing (0000-0001 ms between bytes)
Default = 0 ms
- X33** = Password (12 characters = maximum length; no special characters are allowed.)
- NOTE** A user password cannot be assigned if no administrator password exists; the E14 error code is returned. If the administrator password is cleared, the user password is also removed.

- X34** = Daylight saving time (used in the northern hemisphere [USA] and parts of Europe and Brazil)
 0 = off/ignore
 1 = on in northern hemisphere
 2 = on in Europe
 3 = on in Brazil
- X35** = Event number, range = 0 - 99
- X36** = Event buffer
 0 = receive
 1 = user
 2 = NVRAM
- X37** = Event buffer offset (range = 0 to MaxBufferSize)
- X38** = Event data size
 b = bit
 B = byte (8 bits)
 S = short (16 bits)
 L = long (32 bits)
- NOTE** *This parameter is case sensitive.*
- X39** = Event data to write
- X41** = Read password. RS-232/422 connection responds with the password. The IP connection responds with 4 asterisks (****) if a password exists, and with an empty space if none exists, instead of with an actual password.
- X44** = Number of bytes to read
- X45** = E-mail event number (1 - 64)
- X46** = E-mail recipient's address
- X47** = Name of e-mail file to be sent
 First line of the file is the subject.
 The rest is the body of the e-mail.
- X49** = Default name: a combination of the model-name and the last 3 character pairs of the unit's MAC address (e.g., MGP-464-00-02-3D)
- X51** = Extended security (password) levels: 1-10
 The response is returned as two digits with a leading zero.
- X52** = Connection's security level
 0 = anonymous
 1 through 10 = extended security level
 11 = user
 12 = administrator
- X53** = (Ethernet only) Number of seconds (stated in tens of seconds) before timeout on IP connections (min = 1 (10 seconds), max = 65000 (650,000 seconds), and default = 30 (300 seconds). If no data is received during the timeout period, the Ethernet connection is closed. Each step is 10 seconds. When the unit is connected via RS-232/422, only the global timeout commands apply; anything else returns an E13 error code. The response contains leading zeros.
- X54** = ASCII digit(s) representing the numeric value of the data element read from the event buffer (leading zeros are suppressed)
- X66** = Login without password is allowed. If enabled, the user does not enter a password. After the user clicks OK, the login level is set based on the setting in the **X68** parameter.
 0 = Disabled
 1 = Enabled
- X68** = No-password login level
 1 through 11 = Entry without password goes to the level specified if an administrator password exists.
 0 = Entry without password is placed one level below the lowest password level (0 through 11).
 The response is returned as two digits with a leading zero if needed.
- X69** = Number of seconds (in tens of seconds) before timeout on IP connections
- X70** = Number that is inserted into the e-mail message if the .eml file has an embedded **Esc** ← command with no parameters.
 Use 0 as a placeholder if the optional **X47** is used, but **X70** is not needed.
- X500** = Input 1 through 19
- X502** = Window
 0 = All windows (available only for input selection, Freeze, and window muting)
 1 = Window 1
 2 = Window 2
 3 = Window 3
 4 = Window 4
- X503** = Input video format
 1 = RGB
 2 = YUV-HD
 3 = RGBcvs
 4 = YUVi
 5 = S-video
 6 = Composite
 7 = DVI or HD-SDI
- X504** = Test pattern
 0 = Off
 1 = Colorbars
 2 = X-hatch (crosshatch 16x12)
 3 = 4 x 4 X-hatch
 4 = Grey scale
 5 = Ramp
 6 = Alt. pixels (alternating pixels)
 7 = White field
 8 = Crop
 9 = Side By Side (4x3 crop)
 10 = Quad Split (4x4)
 11 = Pip Images (4 x 3 PIP column)
 12 = 1.78 Aspect (4 x 3/16 x 9 with 1.78 film aspect ratio)
 13 = 1.85 Aspect (4 x 3/16 x 9 with 1.85 film aspect ratio)
 14 = 2.35 Aspect (4 x 3/16 x 9 with 2.35 film aspect ratio)
- X505** = Window text position
 0 = None
 1 = Bottom left
 2 = Bottom center
 3 = Bottom right
 4 = Top left
 5 = Top center
 6 = Top right
- X506** = Window text, 16 characters maximum. The following characters can be used:
Symbols: : / - _ + " (space)
Numerals: 0 through 9
Letters: Lowercase a through z and uppercase A through Z

Software Configuration and Control, cont'd

- X507** = Picture adjustment range (0 - 127; default = 64)
- X508** = Scaler resolution
- 1 = 640 x 480
 - 2 = 800 x 600
 - 3 = 852 x 480
 - 4 = 1024 x 768
 - 5 = 1024 x 852
 - 6 = 1024 x 1024
 - 7 = 1280 x 768
 - 8 = 1280 x 1024
 - 9 = 1360 x 765
 - 10 = 1365 x 768
 - 11 = 1366 x 768
 - 12 = 1365 x 1024
 - 13 = 1400 x 1050
 - 14 = 1600 x 1200
 - 15 = 480p
 - 16 = 576p
 - 17 = 720p
 - 18 = 1080i
 - 19 = 1080p
 - 20 = DVI background input resolution
- X509** = Detected input signal standard
- 0 = None
 - 1 = NTSC
 - 2 = PAL
 - 4 = SECAM
 - = Not applicable (occurs when input is set for RGB or YUV)
- X510** = Sharpness (detail) level (0 through 127)
- X511** = Window transition effect type
- 1 = Cut
 - 2 = Dissolve
 - 3 = Soft wipe up
 - 4 = Soft wipe down
 - 5 = Soft wipe right
 - 6 = Soft wipe left
 - 7 = Soft wipe center in
 - 8 = Soft wipe center out
 - 9 = Soft wipe square in
 - 10 = Soft wipe square out
 - 11 = Soft wipe curtain in
 - 12 = Soft wipe curtain out
 - 13 = Hard wipe up
 - 14 = Hard wipe down
 - 15 = Hard wipe right
 - 16 = Hard wipe left
 - 17 = Hard wipe center in
 - 18 = Hard wipe center out
 - 19 = Hard wipe square in
 - 20 = Hard wipe square out
 - 21 = Hard wipe curtain in
 - 22 = Hard wipe curtain out
- X512** = Blanking adjustment range (0 through 255; default is 128.)
- X513** = Window preset (1 through 128)
- X514** = Input preset (1 through 128)
- X515** = Scaler refresh rate
- 1 = 50 Hz
 - 2 = 60 Hz
 - 3 = 72 Hz
 - 4 = 96 Hz
 - 5 = 100 Hz
 - 6 = 120 Hz
 - 7 = DVI background input refresh rate
- X516** = Pixel phase (0-31)
- X517** = Advanced picture settings value (Range is the auto-sensed value \pm 512 lines or pixels.)
- X518** = Window dissolve speed; 0 to 5 seconds in 0.1 second increments (e.g., 01 = 0.1 second; 50 = 5.0 seconds)
- X519** = Internal temperature in degrees Fahrenheit
- X520** = Text string of up to 200 characters. Permitted characters include letters A-Z, digits 0-9, and the minus sign (-). No blank or space characters are permitted as part of a name. No distinction is made between upper- and lowercase letters. The first character must be a letter. The last character cannot be a minus sign.
- X521** = Image/Window shift value (Zero location is 2048, and limits are \pm the output resolution.)
Example: Front panel displays +50, but the response to the SIS command is 2098.
- X522** = Window size. The minimum size is 1/16 the size of the output active area. The maximum size is the active output area.
- X523** = Image size. The minimum size is 1/16 the size of the input active area. The maximum size is double the active output area for 200% zoom.
- X524** = Window preset effect
- 0 = Cut
 - 1 = Real time motion
- NOTE** *Recalling a window preset with the windows in new positions causes the windows to move to the new location and resize in a fluid motion.*
- X525** = Red, green, or blue color value (0-255)
- X527** = Window priority (1 through 4, where 1 is top priority and 4 is lowest priority)

Command/response table for SIS commands

Command	ASCII (Telnet) (host to processor)	Response (processor to host)	Additional description
Input selection			
Select an input	<code>X500 * X502 !</code>	Out <code>X502</code> • In <code>X500</code> ←	Set input source <code>X500</code> to window <code>X502</code> .
View input	<code>X502 !</code>	<code>X500</code> ←	View the input channel for the selected window. <code>X500</code> = 1 through 19. <code>X502</code> = 0 through 4; 0 = all windows.
Input video type			
Set video type	<code>X500 * X503 \</code>	<code>X500</code> Typ <code>X503</code> ←	Set input <code>X500</code> to format <code>X503</code> .
View video type	<code>X500 \</code>	<code>X503</code> ←	View video signal type for input <code>X500</code> . For <code>X503</code> : 1 = RGB 5 = S-video 2 = YUV-HD 6 = Composite video 3 = RGBcvS 7 = DVI or HD-SDI 4 = YUVi
NOTE It is recommended that virtual inputs be configured using the Windows-based control software. Refer to the software help file for the procedure.			
DVI Input EDID/DDC			
Set EDID information	<code>41 * X508 * X515 #</code>	DDC <code>X508</code> * <code>X515</code> ←	Set the DVI input EDID resolution to <code>X508</code> and the refresh rate to <code>X515</code> . <code>X508</code> = the scaler resolution. For <code>X508</code> : 1 = 640x480 11 = 1366x768 2 = 800x600 12 = 1365x1024 3 = 852x480 13 = 1400x1050 4 = 1024x768 14 = 1600x1200 5 = 1024x852 15 = 480p 6 = 1024x1024 16 = 576p 7 = 1280x768 17 = 720p 8 = 1280x1024 18 = 1080i 9 = 1360x765 19 = 1080p 10 = 1365x768 For <code>X515</code> : 1 = 50 Hz 5 = 100 Hz 2 = 60 Hz 6 = 120 Hz 3 = 72 Hz 4 = 96 Hz
NOTE The default state is to match the output resolution: <code>X508</code> = 0; <code>X515</code> = 0.			
View input	<code>41#</code>	<code>X508</code> * <code>X515</code> ←	View the DVI input EDID resolution/refresh rate.

Command/response table for SIS commands (continued)

Command	ASCII (Telnet) (host to processor)	Response (processor to host)	Additional description
Window blanking (muting)			
Mute window	<u>X502</u> * 1B	<u>X502</u> Blk1 ↵	Blank (mute) window(s) <u>X502</u> using a selected transition effect. <u>X502</u> = 0 through 4; 0 = all windows.
Unmute window	<u>X502</u> * 0B	<u>X502</u> Blk0 ↵	Display (unmute) window(s) <u>X502</u> using a selected transition effect.
View blanking status	<u>X502</u> B	<u>X5</u> ↵	View the window blanking status: 0 = off; 1 = on.
Window priority			
Set priority	<u>X502</u> * <u>X502</u> * <u>X502</u> * <u>X502</u> ~	Pri <u>X502</u> <u>X502</u> <u>X502</u> <u>X502</u> ↵	Set the priority of the windows to the order entered.
View priority	~	<u>X502</u> <u>X502</u> <u>X502</u> <u>X502</u> ↵	Display the priorities of the windows.
Window transition effect			
Select effect	4 * <u>X511</u> #	Eff <u>X511</u> ↵	Select window mute/unmute effect <u>X511</u> . For <u>X511</u> : 1 = Cut 2 = Dissolve 3 = Soft wipe up 4 = Soft wipe down 5 = Soft wipe right 6 = Soft wipe left 7 = Soft wipe center in 8 = Soft wipe center out 9 = Soft wipe square in 10 = Soft wipe sq. out 11 = Soft wipe curtain in 12 = Soft wipe curt. out 11 = Soft wipe curtain in 12 = Soft wipe curtain out 13 = Hard wipe up 14 = Hard wipe down 15 = Hard wipe right 16 = Hard wipe left 17 = Hard wipe center in 18 = Hard wipe center out 19 = Hard wipe square in 20 = Hard wipe sq. out 21 = Hard wipe curtain in 22 = Hard wipe curtain out
View effect	4 *	<u>X511</u> ↵	View the currently selected mute/unmute effect.
Window effect duration			
Select duration	5 * <u>X518</u> #	Dur <u>X518</u> ↵	Set the speed of the window effect to <u>X518</u> . <u>X518</u> = 0 to 5 seconds in 0.1-second increments
View duration	5#	<u>X518</u> ↵	View the effect duration time.

Command/response table for SIS commands (continued)

Command	ASCII (Telnet) (host to processor)	Response (processor to host)	Additional description
Window preset effect			
NOTE For information on setting the two available transition effects for window presets, refer to the MGP 464 Windows-based control software help.			
Select effect	19 # <u>X524</u> #	Wpe <u>X524</u> ←	Set the window preset transition effect to <u>X524</u> . For <u>X524</u> : 0 = Cut 1 = Real time motion
View effect	19#	<u>X524</u> ←	View the current preset transition effect.
Color			
Specific value	<u>X502</u> * <u>X507</u> C	<u>X502</u> Col <u>X507</u> ←	Set color level for window <u>X502</u> to <u>X507</u> . <u>X502</u> = 0 through 4; 0 = all windows. <u>X507</u> = Picture adjustment range — 0 through 127. Default = 64.
Increment color value	<u>X502</u> + C	<u>X502</u> Col <u>X507</u> ←	Select next higher color level.
Decrement color value	<u>X502</u> - C	<u>X502</u> Col <u>X507</u> ←	Select next lower color level.
View color level	<u>X502</u> C	<u>X502</u> ←	View current color level setting.
Tint			
Specific value	<u>X502</u> * <u>X507</u> T	<u>X502</u> Tin <u>X507</u> ←	Set the tint level for window <u>X502</u> to <u>X507</u> .
Increment tint value	<u>X502</u> + T	<u>X502</u> Tin <u>X507</u> ←	Select next higher tint level.
Decrement tint value	<u>X502</u> - T	<u>X502</u> Tin <u>X507</u> ←	Select next lower tint level.
View tint level	<u>X502</u> T	<u>X502</u> ←	View current tint level setting.
Contrast			
Specific value	<u>X502</u> * <u>X507</u> ^	<u>X502</u> Con <u>X507</u> ←	Set the contrast level for window <u>X502</u> to <u>X507</u> .
Increment contrast value	<u>X502</u> + ^	<u>X502</u> Con <u>X507</u> ←	Select next higher contrast level.
Decrement contrast value	<u>X502</u> - ^	<u>X502</u> Con <u>X507</u> ←	Select next lower contrast level.
View contrast level	<u>X502</u> ^	<u>X502</u> ←	View current contrast level setting.
Brightness			
Specific value	<u>X502</u> * <u>X507</u> Y	<u>X502</u> Brt <u>X507</u> ←	Set the brightness level for window <u>X502</u> to <u>X507</u> .
Increment brightness value	<u>X502</u> + Y	<u>X502</u> Brt <u>X507</u> ←	Select next higher brightness level.
Decrement brightness value	<u>X502</u> - Y	<u>X502</u> Brt <u>X507</u> ←	Select next lower brightness level.
View brightness level	<u>X502</u> Y	<u>X502</u> ←	View current brightness level setting.

Command/response table for SIS commands (continued)

Command	ASCII (Telnet) (host to processor)	Response (processor to host)	Additional description
Detail filter			
Specific value	$\boxed{X502} * \boxed{X510} D$	$\boxed{X502}$ Det $\boxed{X510}$ ←	Set detail (sharpness) level for window $\boxed{X502}$ to $\boxed{X510}$. $\boxed{X502}$ = 0 through 4; 0 = all windows. $\boxed{X510}$ = 0 through 127.
Increment detail level	$\boxed{X502} + D$	$\boxed{X502}$ Det $\boxed{X510}$ ←	Select next higher sharpness level.
Decrement detail level	$\boxed{X502} - D$	$\boxed{X502}$ Det $\boxed{X510}$ ←	Select next lower sharpness level.
View detail value	$\boxed{X502} D$	$\boxed{X510}$ ←	View current sharpness level setting.
Horizontal shift (window)			
NOTE For the shift values shown for the next two commands, the zero location is 2048. When you enter a shift value via the front panel, the LCD screen shows only the amount of lines or pixels the window has shifted. The SIS response gives the actual location of the window in pixels.			
Example: The LCD window displays +50, but the response to the SIS command is 2098.			
Specific value	$1 * \boxed{X502} * \boxed{X521} H$	$\boxed{X502}$ Whp $\boxed{X521}$ ←	Set horizontal centering of window $\boxed{X502}$ to $\boxed{X521}$. For $\boxed{X521}$: 0 = 2048; limits are ± the output resolution.
	$1 * \boxed{X502} + H$	$\boxed{X502}$ Whp $\boxed{X521}$ ←	Shift window $\boxed{X502}$ right.
Decrement horizontal window shift	$1 * \boxed{X502} - H$	$\boxed{X502}$ Whp $\boxed{X521}$ ←	Shift window $\boxed{X502}$ left.
View horizontal window shift amount	$1 * \boxed{X502} H$	$\boxed{X521}$ ←	View amount of horizontal window shift.
Vertical shift (window)			
Specific value	$1 * \boxed{X502} * \boxed{X521} /$	$\boxed{X502}$ Wvp $\boxed{X521}$ ←	Set vertical centering of window $\boxed{X502}$ to $\boxed{X521}$.
Increment vertical window shift	$1 * \boxed{X502} + /$	$\boxed{X502}$ Wvp $\boxed{X521}$ ←	Shift window $\boxed{X502}$ up.
Decrement vertical window shift	$1 * \boxed{X502} - /$	$\boxed{X502}$ Wvp $\boxed{X521}$ ←	Shift window $\boxed{X502}$ down.
View vertical window shift amount	$1 * \boxed{X502} /$	$\boxed{X521}$ ←	View amount of vertical shift.
Horizontal shift (image)			
Specific value	$2 * \boxed{X502} * \boxed{X521} H$	$\boxed{X502}$ Ihp $\boxed{X521}$ ←	Set horizontal centering of the image in window $\boxed{X502}$ to $\boxed{X521}$.
Increment horizontal image shift	$2 * \boxed{X502} + H$	$\boxed{X502}$ Ihp $\boxed{X521}$ ←	Shift image in window $\boxed{X502}$ right.
Decrement horizontal image shift	$2 * \boxed{X502} - H$	$\boxed{X502}$ Ihp $\boxed{X521}$ ←	Shift image in window $\boxed{X502}$ left.
View horizontal image shift amount	$2 * \boxed{X502} H$	$\boxed{X521}$ ←	View current setting for horizontal centering of the image in window $\boxed{X502}$.

Command/response table for SIS commands (continued)

Command	ASCII (Telnet) (host to processor)	Response (processor to host)	Additional description
Vertical shift (image)			
Specific value	2 * $\boxed{X502}$ * $\boxed{X521}$ /	$\boxed{X502}$ Ivp $\boxed{X521}$ ←	Set vertical centering of the image in window $\boxed{X502}$ to $\boxed{X521}$. $\boxed{X502}$ = 0 through 4; 0 = all windows. For $\boxed{X521}$: 0 = 2048; limits are ± the output resolution.
Increment vertical image shift	2 * $\boxed{X502}$ + /	$\boxed{X502}$ Ivp $\boxed{X521}$ ←	Shift image in window $\boxed{X502}$ up.
Decrement vertical image shift	2 * $\boxed{X502}$ - /	$\boxed{X502}$ Ivp $\boxed{X521}$ ←	Shift image in window $\boxed{X502}$ down.
View vertical image shift amount	2 * $\boxed{X502}$ /	$\boxed{X521}$ ←	View current setting for vertical centering of the image in window $\boxed{X502}$.
Horizontal size (window)			
Specific value	1 * $\boxed{X502}$ * $\boxed{X522}$:	$\boxed{X502}$ Whs $\boxed{X522}$ ←	Set the width of window $\boxed{X502}$ to $\boxed{X522}$. For $\boxed{X522}$: Minimum = 1/16 the size of the active output area. Maximum = size of the active output area.
Increase horizontal size of window	1 * $\boxed{X502}$ + :	$\boxed{X502}$ Whs $\boxed{X522}$ ←	Widen the window.
Decrease horizontal size of window	1 * $\boxed{X502}$ - :	$\boxed{X502}$ Whs $\boxed{X522}$ ←	Narrow the window.
View horizontal size of window	1 * $\boxed{X502}$:	$\boxed{X522}$ ←	View the width of the window.
Vertical size (window)			
Specific value	1 * $\boxed{X502}$ * $\boxed{X522}$;	$\boxed{X502}$ Wvs $\boxed{X522}$ ←	Set the height of window $\boxed{X502}$ to $\boxed{X522}$.
Increase vertical size of window	1 * $\boxed{X502}$ + ;	$\boxed{X502}$ Wvs $\boxed{X522}$ ←	Increase the height of the window.
Decrease vertical size of window	1 * $\boxed{X502}$ - ;	$\boxed{X502}$ Wvs $\boxed{X522}$ ←	Decrease the height of the window.
View vertical size of window	1 * $\boxed{X502}$;	$\boxed{X522}$ ←	View the height of the window.
Horizontal size (image)			
Specific value	2 * $\boxed{X502}$ * $\boxed{X523}$:	$\boxed{X502}$ Ihs $\boxed{X523}$ ←	Set the width of the image in window $\boxed{X502}$ to $\boxed{X523}$. For $\boxed{X523}$: Minimum = 1/16 the size of the active input area. Maximum = double the active output area for 200% zoom.
Increase horizontal size of image	2 * $\boxed{X502}$ + :	$\boxed{X502}$ Ihs $\boxed{X523}$ ←	Widen the image.
Decrease horizontal size of image	2 * $\boxed{X502}$ - :	$\boxed{X502}$ Ihs $\boxed{X523}$ ←	Narrow the image.
View horizontal size of image	2 * $\boxed{X502}$:	$\boxed{X523}$ ←	View the width of the image.

Command/response table for SIS commands (continued)

Command	ASCII (Telnet) (host to processor)	Response (processor to host)	Additional description
Vertical size (image)			
Specific value	2 * $\boxed{X502}$ * $\boxed{X523}$;	$\boxed{X502}$ Ivs $\boxed{X523}$ ↵	Set the height of the image in window $\boxed{X502}$ to $\boxed{X523}$. $\boxed{X502}$ = 0 through 4; 0 = all windows. For $\boxed{X523}$: Minimum = 1/16 the size of the active input area. Maximum = double the active output area for 200% zoom.
Increase vertical size of image	2 * $\boxed{X502}$ + ;	$\boxed{X502}$ Ivs $\boxed{X523}$ ↵	Increase the height of the image in window $\boxed{X502}$.
Decrease vertical size of image	2 * $\boxed{X502}$ - ;	$\boxed{X502}$ Ivs $\boxed{X523}$ ↵	Decrease the height of the image in window $\boxed{X502}$.
View vertical size of image	2 * $\boxed{X502}$;	$\boxed{X523}$ ↵	View the height of the image in window $\boxed{X502}$.
Picture control copy			
Copy picture controls	21 * $\boxed{X502}$ #	Pcc $\boxed{X500}$ ↵	Copy the picture controls for currently displayed input $\boxed{X500}$ to window $\boxed{X502}$. $\boxed{X500}$ = 1 through 19.
Window size and position			
Set window size and position	\boxed{Esc} $\boxed{X502}$, $\boxed{X521}$ * $\boxed{X521}$ * $\boxed{X522}$ * $\boxed{X522}$ X Y ↵ Wxy $\boxed{X502}$, $\boxed{X521}$ * $\boxed{X521}$ * $\boxed{X522}$ * $\boxed{X522}$ ↵		Set the position and size of window $\boxed{X502}$ to $\boxed{X521}$ and $\boxed{X522}$, respectively. For $\boxed{X521}$: 0 = 2048; limits are ± the output resolution. For $\boxed{X522}$: Minimum = 1/16 the size of the active output area. Maximum = size of the active output area..
NOTE The variables must be entered in the following order: Horizontal position, vertical position, horizontal size, vertical size.			
View size and position	\boxed{Esc} $\boxed{X502}$ X Y ↵	$\boxed{X502}$, $\boxed{X521}$ * $\boxed{X521}$ * $\boxed{X522}$ * $\boxed{X522}$ ↵	View the position and size of window $\boxed{X502}$.

Command/response table for SIS commands (continued)

Command	ASCII (Telnet) (host to processor)	Response (processor to host)	Additional description
Image size and position			
Set image size and position	<code>[Esc] X502 , X521 * X521 * X523 * X523 I Y ←</code>	<code>Ixy X502 , X521 * X521 * X523 * X523 ↵</code>	Set position and size of the image in window <code>X502</code> . <code>X502</code> = 0 through 4; 0 = all windows. For <code>X521</code> : 0 = 2048; limits are ± the output resolution. For <code>X523</code> : Minimum = 1/16 the size of the active input area. Maximum = double the active output area for 200% zoom.
NOTE The variables must be entered in the following order: Horizontal position, vertical position, horizontal size, vertical size.			
View image size and position	<code>[Esc] X502 I Y ←</code>	<code>X502 , X521 * X521 * X523 * X523 ↵</code>	View position and size of the image in window <code>X502</code> .
Zoom mode (window)			
Zoom in	<code>1 * X502 + {</code>	<code>X502 Wzm ↵</code>	Increase the size of window <code>X502</code> while keeping the aspect ratio constant.
Zoom out	<code>1 * X502 - {</code>	<code>X502 Wzm ↵</code>	Decrease the size of window <code>X502</code> while keeping the aspect ratio constant.
Zoom mode (image)			
Zoom in	<code>2 * X502 + {</code>	<code>X502 Izm ↵</code>	Increase the size of the image in window <code>X502</code> while keeping the aspect ratio constant.
Zoom out	<code>2 * X502 - {</code>	<code>X502 Izm ↵</code>	Decrease the size of the image in window <code>X502</code> while keeping the aspect ratio constant.
Window presets			
Recall window preset without input	<code>1 * X513 .</code>	<code>Rpr 1 * X513 ↵</code>	Recall window preset <code>X513</code> without input settings. <code>X513</code> = 1 through 128.
Recall window preset with input	<code>2 * X513 .</code>	<code>Rpr 2 * X513 ↵</code>	Recall window preset <code>X513</code> with input settings.
Save window preset	<code>2 * X513 ,</code>	<code>Spr 2 * X513 ↵</code>	Save window settings to a preset at location <code>X513</code> .
Preset preview	<code>[Esc] X513 * X502 XY ←</code>	<code>Wxy X513 * X502 * X527 * X521 * X521 * X522 * X522 ↵</code>	View the size, priority, and position of window <code>X502</code> saved as preset <code>X513</code> . <code>X527</code> = 1 through 4; 1 = top priority

Command/response table for SIS commands (continued)

Command	ASCII (Telnet) (host to processor)	Response (processor to host)	Additional description
Input presets			
Recall input preset	3 * $\overline{X502}$ * $\overline{X514}$.	Rpr 3 * $\overline{X514}$ ↵	Recall input preset $\overline{X514}$ to window $\overline{X502}$. $\overline{X502}$ = 0 through 4; 0 = all windows. $\overline{X514}$ = 1 through 128.
Save input preset	3 * $\overline{X502}$ * $\overline{X514}$,	Spr 3 * $\overline{X514}$ ↵	Save the input settings for window $\overline{X502}$ to input preset $\overline{X514}$.
Input naming			
Write input name	Esc $\overline{X500}$, $\overline{X506}$ NI ←	Nmi $\overline{X500}$, $\overline{X506}$ ↵	Create a text label containing name $\overline{X506}$ for input $\overline{X500}$. $\overline{X500}$ = 1 through 19. $\overline{X506}$ = up to 16 characters. For $\overline{X506}$ use: Symbols: : / - _ + " (space) Numerals: 0 through 9 Letters: Lowercase a through z and uppercase A through Z
Read input name	Esc $\overline{X500}$ NI ←	$\overline{X506}$ ↵	View contents of the name label for input $\overline{X500}$.
Window preset naming			
NOTE Window preset names cannot be viewed on the LCD screen. They can be viewed on the MGP 464 Web page, the Windows-based control software, or via SIS commands.			
Write preset name	Esc $\overline{X513}$, $\overline{X506}$ NP ←	Nmp $\overline{X513}$, $\overline{X506}$ ↵	Give the window preset $\overline{X513}$ the name $\overline{X506}$. $\overline{X513}$ = 1 through 128.
Read preset name	Esc $\overline{X513}$ NP ←	$\overline{X506}$ ↵	View window preset name $\overline{X506}$.
Vertical start			
Specific value	$\overline{X500}$ * $\overline{X512}$ (Vst $\overline{X500}$ * $\overline{X512}$ ↵	Set the vertical position of the first active pixel for input $\overline{X500}$ to $\overline{X512}$. $\overline{X512}$ = 0 through 255; default = 128.
Increment vertical start value	$\overline{X500}$ + (Vst $\overline{X500}$ * $\overline{X512}$ ↵	Increase vertical start location value for input $\overline{X500}$.
Decrement vertical start value	$\overline{X500}$ - (Vst $\overline{X500}$ * $\overline{X512}$ ↵	Decrease vertical start location value for input $\overline{X500}$.
View vertical start setting	$\overline{X500}$ ($\overline{X512}$ ↵	View the vertical start location of the first active pixel in the active window.

Command/response table for SIS commands (continued)

Command	ASCII (Telnet) (host to processor)	Response (processor to host)	Additional description
Horizontal start			
Specific value	$\boxed{X500} * \boxed{X512})$	Hst $\boxed{X500} * \boxed{X512} \leftarrow$	Set the horizontal position of the first active pixel in the active window (input $\boxed{X500}$) to $\boxed{X512}$. $\boxed{X500}$ = 1 through 19. $\boxed{X512}$ = 0 through 255; default = 128.
Increment horizontal start value	$\boxed{X500} +)$	Hst $\boxed{X500} * \boxed{X512} \leftarrow$	Increase the horizontal start location value for input $\boxed{X500}$.
Decrement horizontal start value	$\boxed{X500} -)$	Hst $\boxed{X500} * \boxed{X512} \leftarrow$	Decrease the horizontal start location value for input $\boxed{X500}$.
View horizontal start setting	$\boxed{X500})$	$\boxed{X512} \leftarrow$	View the horizontal start location of the first active pixel in the active window.
Pixel phase (available only for RGB and YUV-HD input signals)			
Specific value	$\boxed{X502} * \boxed{X516} U$	$\boxed{X502}$ Phs $\boxed{X500} * \boxed{X516} \leftarrow$	Set the pixel phase value for the input in window $\boxed{X502}$ to $\boxed{X516}$. $\boxed{X502}$ = 0 through 4; 0 = all windows. $\boxed{X516}$ = 0 through 31.
Increment pixel phase value	$\boxed{X502} + U$	$\boxed{X502}$ Phs $\boxed{X500} * \boxed{X516} \leftarrow$	Select the next higher pixel phase value.
Decrement pixel phase value	$\boxed{X502} - U$	$\boxed{X502}$ Phs $\boxed{X500} * \boxed{X516} \leftarrow$	Select the next lower pixel phase value.
View pixel phase setting	$\boxed{X502} U$	$\boxed{X516} \leftarrow$	View the current pixel phase setting for the input in window $\boxed{X502}$.
Total pixels			
Specific value	11 * $\boxed{X500} * \boxed{X517} \#$	Tpx $\boxed{X500} * \boxed{X517} \leftarrow$	Set the total pixels value for input $\boxed{X500}$ to $\boxed{X517}$. $\boxed{X517}$ = Auto-sensed value \pm 512 lines or pixels.
Increment total pixels value	11 * $\boxed{X500} + \#$	Tpx $\boxed{X500} * \boxed{X517} \leftarrow$	Select the next higher total pixels value for input $\boxed{X500}$.
Decrement total pixels value	11 * $\boxed{X500} - \#$	Tpx $\boxed{X500} * \boxed{X517} \leftarrow$	Select the next lower total pixels value for input $\boxed{X500}$.
View total pixels setting	11 * $\boxed{X500} \#$	$\boxed{X517} \leftarrow$	View the current total pixels setting for input $\boxed{X500}$.
Active pixels			
Specific value	12 * $\boxed{X500} * \boxed{X517} \#$	Apx $\boxed{X500} * \boxed{X517} \leftarrow$	Set the active pixels value for input $\boxed{X500}$ to $\boxed{X517}$.
Increment active pixels value	12 * $\boxed{X500} + \#$	Apx $\boxed{X500} * \boxed{X517} \leftarrow$	Select the next higher active pixels value for input $\boxed{X500}$.
Decrement active pixels value	12 * $\boxed{X500} - \#$	Apx $\boxed{X500} * \boxed{X517} \leftarrow$	Select the next lower active pixels value for input $\boxed{X500}$.
View active pixels setting	12 * $\boxed{X500} \#$	$\boxed{X517} \leftarrow$	View current active pixels value for input $\boxed{X500}$.

Command/response table for SIS commands (continued)

Command	ASCII (Telnet) (host to processor)	Response (processor to host)	Additional description
Active lines			
Specific value	13 * $\boxed{X500}$ * $\boxed{X517}$ #	Aln $\boxed{X500}$ * $\boxed{X517}$ ↵	Set the active lines value for the input $\boxed{X500}$ to $\boxed{X517}$. $\boxed{X500}$ = 1 through 19. $\boxed{X517}$ = Auto-sensed value ± 512 lines or pixels.
Increment active lines value	13 * $\boxed{X500}$ + #	Aln $\boxed{X500}$ * $\boxed{X517}$ ↵	Select the next higher active lines value.
Decrement active lines value	13 * $\boxed{X500}$ - #	Aln $\boxed{X500}$ * $\boxed{X517}$ ↵	Select the next lower active lines value.
View active lines setting	13 * $\boxed{X500}$ #	$\boxed{X517}$ ↵	View the current active lines setting for input $\boxed{X500}$.
Output scaler rate			
Set output resolution and scan rate	$\boxed{X508}$ * $\boxed{X515}$ =	Rte $\boxed{X508}$ * $\boxed{X515}$ ↵	Select a scaler output resolution and scan rate. $\boxed{X508}$ = scaler resolution. For $\boxed{X508}$: 1 = 640x480 11 = 1366x768 2 = 800x600 12 = 1365x1024 3 = 852x480 13 = 1400x1050 4 = 1024x768 14 = 1600x1200 5 = 1024x852 15 = 480p 6 = 1024x1024 16 = 576p 7 = 1280x768 17 = 720p 8 = 1280x1024 18 = 1080i 9 = 1360x765 19 = 1080p 10 = 1365x768 20 = DVI background input resol. $\boxed{X515}$ = scaler refresh rate. For $\boxed{X515}$: 1 = 50 Hz 5 = 100 Hz 2 = 60 Hz 6 = 120 Hz 3 = 72 Hz 7 = DVI background input refresh rate 4 = 96 Hz
View output rate settings	=	$\boxed{X508}$ * $\boxed{X515}$ ↵	View the current output's resolution and refresh rate settings.
View output rate details	0 =	<i>width * height * refresh rate</i> ↵	View the current output's size and refresh rate.
NOTE The output rate detail command can display the actual resolution of the output when the MGP is configured to use the DVI background rate.			
Freeze			
Enable freeze	$\boxed{X502}$ * 1 F	$\boxed{X502}$ Frz 1 ↵	Freeze the output video image in window $\boxed{X502}$. $\boxed{X502}$ = 0 through 4; 0 = all windows.
Disable freeze	$\boxed{X502}$ * 0 F	$\boxed{X502}$ Frz 0 ↵	Unfreeze the output image.
View freeze status	$\boxed{X502}$ F	$\boxed{X5}$ ↵	View the freeze status. For $\boxed{X5}$: 1 = frozen; 0 = not frozen.

Command/response table for SIS commands (continued)

Command	ASCII (Telnet) (host to processor)	Response (processor to host)	Additional description
Test pattern			
Set test pattern	<u>X504</u> J	Tst <u>X504</u> ↵	Select test pattern <u>X504</u> . For <u>X504</u> : 0 = Off (none) 8 = Crop 1 = Colorbars 9 = Side By Side (4x3 crop) 2 = X-hatch (16x12) 10 = Quad Split (4x4) 3 = 4x4 H-hatch 11 = Pip Images (4x3 PIP col.) 4 = Grey scale 12 = 1.78 Aspect (4x3/16x9) 5 = Ramp 13 = 1.85 Aspect (4x3/16x9) 6 = Alt. pixels 14 = 2.35 Aspect (4x3/16x9) 7 = White field
View test pattern	J	<u>X504</u> ↵	View the currently selected test pattern.
Executive mode			
Enable executive mode	1X	Exe 1 ↵	Lock front panel control except for the input buttons; allow RS-232/422 and Ethernet control.
Enable executive mode 2	2X	Exe 2 ↵	Lock all front panel controls including input buttons; allow RS-232/422 and Ethernet control.
Disable executive mode	0X	Exe 0 ↵	Unlock all front panel controls.
View executive mode status	X	0 ↵ / 1 ↵ / 2 ↵	View executive mode status.
Information requests			
General information	<u>X502</u> * I	Chn <u>X500</u> • Typ <u>X503</u> • Std <u>X509</u> • Blk <u>X5</u> ↵	View input number, video signal type, input signal standard, and blanking (muting) status in window <u>X502</u> . <u>X500</u> = 1 through 19. <u>X503</u> = signal type. For <u>X503</u> : 1 = RGB 5 = S-video 2 = YUV-HD 6 = Composite video 3 = RGBcvS 7 = DVI 4 = YUVi <u>X509</u> = signal standard. For <u>X509</u> : 0 = None 4 = SECAM 1 = NTSC - = Not applicable 2 = PAL <u>X5</u> = muting status. For <u>X5</u> : 1 = muted; 0 = unmuted

Command/response table for SIS commands (continued)

Command	ASCII (Telnet) (host to processor)	Response (processor to host)	Additional description
Information requests (continued)			
Query firmware version	Q	x.xx ↵	View the firmware version number.
Query part number	N	60-771-01 or 60-771-02	View the MGP's part number.
View internal temperature	20S	<u>X519</u> ↵	View internal temperature <u>X519</u> in degrees Fahrenheit.
<i>With tagged response – Verbose modes 2 and 3:</i> Sts20 * <u>X519</u> ↵			
Special functions			
Output polarity	1 * <u>X1</u> #	Pol <u>X1</u> ↵	Set output polarity. For <u>X1</u> : 0 = H- /V- (default) 1 = H- /V+ 2 = H+ /V- 3 = H+ /V+ H+ /V- sync polarity
<i>Example:</i>	1 * 2 #	Pol 2 ↵	
View output polarity	1 #	<u>X1</u> ↵	View the current output polarity setting.
Output sync format	2 * <u>X1</u> #	Syn <u>X1</u> ↵	Set the output sync format. For <u>X1</u> : 1 = RGBHV 2 = RGBS 3 = RGsB 4 = YUV bi-level 5 = YUV tri-level
View output sync format	2 #	<u>X1</u> ↵	View the current output sync format setting.
Blue mode	3 * <u>X5</u> #	Blu <u>X5</u> ↵	Turn blue mode on and off. For <u>X5</u> : 1 = blue mode on; 0 = blue mode off.
View blue mode status	3 #	<u>X5</u> ↵	View the current blue mode status.
Text position	6 * <u>X502</u> * <u>X505</u> #	<u>X502</u> Tlc <u>X505</u> ↵	Change the location of the text label to <u>X505</u> in window <u>X502</u> . <u>X502</u> = 0 through 4; 0 = all windows. For <u>X505</u> : 0 = None 4 = Top left 1 = Bottom left 5 = Top center 2 = Bottom center 6 = Top right 3 = Bottom right
View text position	6 * <u>X502</u> #	<u>X505</u> ↵	View the text label position in window <u>X502</u> .

Command/response table for SIS commands (continued)

Command	ASCII (Telnet) (host to processor)	Response (processor to host)	Additional description
Special functions (continued)			
Text size	10 * <u>X1</u> #	Tsz <u>X1</u> ↵	Set the size of the label text. For <u>X1</u> : 1 = Small 2 = Medium 3 = Large
View text size	10 #	<u>X1</u> ↵	View the current size of the label text.
Text border color	14 * <u>X502</u> * <u>X1</u> #	<u>X502</u> Txb <u>X1</u>	Change the color of the text label border in window <u>X502</u> . <u>X502</u> = 0 through 4; 0 = all windows. For <u>X1</u> : 0 = Off (no border) 5 = Magenta 1 = Red 6 = Cyan 2 = Green 7 = Yellow 3 = Blue 8 = Black 4 = White 9 = Translucent
View text border color	14 * <u>X502</u> #	<u>X1</u> ↵	View the current border color of the text label in window <u>X502</u> .
Text color	16 * <u>X502</u> * <u>X1</u> #	<u>X502</u> Txc <u>X1</u> ↵	Set the color of the text in the label in window <u>X502</u> to <u>X1</u> . For <u>X1</u> : 1 = Red 5 = Magenta 2 = Green 6 = Cyan 3 = Blue 7 = Yellow 4 = White 8 = Black
View text color	16 * <u>X502</u> * #	<u>X1</u> ↵	View the current color of the text in window <u>X502</u> .
Text background color	17 * <u>X502</u> * <u>X1</u> #	<u>X502</u> Tbc <u>X1</u> ↵	Set the background color of the text label in window <u>X502</u> to <u>X1</u> . For <u>X1</u> : 0 = Off (none) 5 = Magenta 1 = Red 6 = Cyan 2 = Green 7 = Yellow 3 = Blue 8 = Black 4 = White 9 = Translucent
View text background color	17 * <u>X502</u> #	<u>X1</u> ↵	View the current color of the text label background in window <u>X502</u> .

Command/response table for SIS commands (continued)

Command	ASCII (Telnet) (host to processor)	Response (processor to host)	Additional description
Special functions (continued)			
Window border color	9 * $\overline{X502}$ * $\overline{X!}$ #	$\overline{X502}$ Brd $\overline{X!}$ ↵	Set the color of the border around window $\overline{X502}$ to $\overline{X!}$. $\overline{X502}$ = 0 through 4; 0 = all windows. For $\overline{X!}$: 0 = Off (no border) 5 = Magenta 1 = Red 6 = Cyan 2 = Green 7 = Yellow 3 = Blue 8 = Black 4 = White
View window border color	9 * $\overline{X502}$ #	$\overline{X!}$ ↵	View the current border color in window $\overline{X502}$.
Background color			
Set background color	8 * $\overline{X!}$ #	Bkg $\overline{X!}$ ↵	Set a background color for the output screen. For $\overline{X!}$: 0 = Off (default) 6 = Cyan 1 = Red 7 = Yellow 2 = Green 8 = Background image 3 = Blue 9 = DVI background input 4 = White 10 = Custom color 5 = Magenta
View background color	8 #	$\overline{X!}$ ↵	View the current background color setting.
Set custom color	22 * $\overline{X525}$ * $\overline{X525}$ * $\overline{X525}$ #	Ubk $\overline{X525}$ * $\overline{X525}$ * $\overline{X525}$ ↵	Set custom color values for red, green, and blue, in that order. $\overline{X525}$ = 0 through 255.
View custom color	22#	Ubk $\overline{X525}$ * $\overline{X525}$ * $\overline{X525}$ ↵	
Background image			
Save image	\overline{Esc} 0 , filename MF ↵	Ims filename ↵	Save the current output image to memory under the designated name.
NOTE The filename must be no more than 16 characters, including the .bmp extension.			
Recall image	\overline{Esc} 0 , filename RF ↵	Imr filename ↵	Recalls the image with the specified file name and displays it as a background
Current image	\overline{Esc} RF ↵	filename ↵	View the name of the currently displayed background image.

Command/response table for SIS commands (continued)

Command	ASCII (Telnet) (host to processor)	Response (processor to host)	Additional description
Film mode			
Enable film mode	18 * <u>X500</u> * 1 #	<u>X500</u> Flm 1 ↵	Enable film mode for input <u>X500</u> . (Auto-senses for 3:2 or 2:2 pull-down.) <u>X500</u> = 1 through 19.
Disable film mode	18 * <u>X500</u> * 0 #	<u>X500</u> Flm 0 ↵	Disable film mode for input <u>X500</u> . (Blocks the deinterlacer from using either pull-down method.)
View film mode status	18 * <u>X500</u> #	0 ↵ (off) or 1 ↵ (on)	View the current film mode setting for input <u>X500</u> .
Auto image			
Run Auto image	55 * <u>X502</u> #	Img <u>X502</u> ↵	Runs Auto image on window <u>X502</u> . <u>X502</u> = 1 through 4.

Command/response table for IP SIS commands

Command	ASCII (Telnet) (host to processor)	URL Encoded (Web) (host to processor)	Response (Processor to host)	Additional description
Bi-directional serial data port				
Send data string	<code>[Esc] [X1] * [X17] * [X20] * [X21] RS ← [X2]</code>	<code>W [X1] %2A [X1] %2A [X20] %2A [X21] RS [X2]</code>	<code>[X2]</code>	Response from command ↵
NOTE	<p>[X1] = Port number (01-99).</p> <p>[X17] = Time in tens of milliseconds that the MGP will wait until receipt of the first response character before terminating the command. (Default = 10 = 10 ms; max. = 32767.)</p> <p>[X20] = Time in tens of milliseconds that the MGP will wait between characters being received via a serial port before terminating the current command or receive operation. (Default = 20 = 20 ms; max. = 32767.)</p> <p>[X21] = #L or #D. The letter parameter is case sensitive (requires capital D or capital L). L = Length of the message to be received. D = Delimiter value. A delimiter of ASCII 0A = 10D. # = Byte count (for L) or a single ASCII character expressed in decimal form (for D). Byte count # can be 0 - 32767; default = 0. The ASCII decimal # can be 0 - 00255; default = the byte count. A 3-byte length = 3L. The response includes leading zeros.</p> <p>[X2] = Command data section. For Web encoding for [X2], be sure to convert non-alphanumeric characters to hex numbers.</p>			
Example:	<code>[Esc] 05 * 4 * 7 * 3L RS ← <data> •</code>	<code>W05 %2A 4 %2A 7 %2A 3L RS <data></code>	<code>[X2]</code>	Response from command ↵
NOTE	The * [X17] * [X20] * [X21] sequence is optional. If [X17] and [X20] are not specified, the default values are used.			
Configure serial port parameters ²⁴	<code>[Esc] [X1] * [X25] , [X26] , [X27] , [X28] CP ←</code>	<code>W [X1] %2A [X25] %2A [X26] %2A [X27] %2A [X28] CP </code>	<code>Cpn [X1] • Ccp [X25] , [X26] , [X27] , [X28] CP ↵</code>	Set baud rate [X25], parity [X26], [X27] data bits, and [X28] stop bits for port [X1] [X25] = 300, 600, 1200, 1800, 2400, 3600, 4800, 7200, 9600, 14400, 19200, 28800, 38400, 57600, or 115200. [X26] = odd, even, none, mark, or space. (Only the first letter is required.) [X27] = 7 or 8 [X28] = 1 or 2
View serial port parameters	<code>[Esc] [X1] CP ←</code>	<code>W [X1] CP </code>	<code>[X25] , [X26] , [X27] , [X28] CP ↵</code>	

Command/response table for IP SIS commands (continued)

Command	ASCII (Telnet) (host to processor)	URL Encoded (Web) (host to processor)	Response (Processor to host)	Additional description
Bi-directional serial data port (continued)				
Configure mode ²⁴	<code>[Esc] X1 * X29 CY ←</code>	<code>W X1 %2A X29 CY </code>	<code>Cpn X1 • Cty X29 ↵</code>	Select serial mode <code>X29</code> for port <code>X1</code> . <code>X1</code> = 01 through 99. For <code>X29</code> : 0 = RS-232 1 = RS-422 NOTE Only the rear panel RS-232/422 port can be configured. Therefore, <code>X1</code> = 1.
View mode	<code>[Esc] X1 CP ←</code>	<code>W X1 CY </code>	<code>X29 ↵</code>	
Configure flow control ²⁴	<code>[Esc] X1 * X30 , X31 CF ←</code>	<code>W X1 %02A X30 %02C X31 CF </code>	<code>Cpn X1 • Cfl X30 , X31 ↵</code>	Set flow control type <code>X30</code> with <code>X31</code> ms between bytes. For <code>X30</code> : H = Hardware. S = Software. N = None (default). <code>X31</code> = 0000 through 0001; default = 0 ms.
View flow control	<code>[Esc] X1 CF ←</code>	<code>W X1 CF </code>	<code>X30 , X31 ↵</code>	
Configure receive timeout ²⁴	<code>[Esc] X1 * X17 * X20 * X23 * X21 CE ←</code>	<code>W X1 %2A X17 %2A X20 %2A X23 %2A X21 CE </code>	<code>Cpn X1 • Cce X17 , X20 , X23 , X21 CE ↵</code>	Set the time that the MGP will wait for a response before terminating the command.
<p>NOTE <code>X17</code> = Time in tens of milliseconds that the MGP will wait until receipt of the first response character before terminating the command. (Default = 10 = 10 ms; max. = 32767.)</p> <p><code>X20</code> = Time in tens of milliseconds that the MGP will wait between characters being received via a serial port before terminating the current command or receive operation. (Default = 20 = 20 ms; max. = 32767.)</p> <p><code>X21</code> = #L or #D. The letter parameter is case sensitive (requires capital D or capital L). For <code>X21</code>: L = Length of the message to be received, D = Delimiter value. A delimiter of ASCII 0A = 10D. # = Byte count (for L) or a single ASCII character expressed in decimal form (for D). Byte count # can be 0 through 32767; default = 0. The ASCII decimal # can be 0 through 00255; default = the byte count. A 3-byte length = 3L. The response includes leading zeros.</p> <p><code>X23</code> = Priority Status for port <code>X1</code> receiving timeouts. For <code>X23</code>: 0 = Use Send data string command parameters (default); 1 = Use Configure receive timeout command parameters. The response includes leading zeros.</p>				
View receive timeout	<code>[Esc] X1 CE ←</code>	<code>W X1 CE </code>	<code>X17 , X20 , X23 , X21 ↵</code>	

Command/response table for IP SIS commands (continued)

Command	ASCII (Telnet) (host to processor)	URL Encoded (Web) (host to processor)	Response (Processor to host)	Additional description
Ethernet data port				
Set current connection port timeout	Esc 0 * X69 TC ←	W 0 %2A X69 TC	Pti 0 * X69 ↵	Set number of seconds (in tens of seconds) before timeout on IP connections. X69 = 1 through 32767.
View current connection port timeout	Esc 0TC ←	W 0TC	X69 ↵	
Set global IP port timeout	Esc 1 * X69 TC ←	W 1 %2A X69 TC	Pti 1 * X69 ↵	
View global port timeout	Esc 1TC ←	W 1TC	X69 ↵	
Firmware version requests				
NOTE An asterisk (*) after the version number in these commands indicates which version is currently running. A caret (^) indicates bad checksum/invalid load. Question marks (???) indicate that the firmware version is not loaded.				
Query firmware version	Q or 1Q	Q or 1Q	X11 ↵	Show the MGP's firmware version number X11 to two decimal places. Gives the number of the currently running version of the user-updatable firmware.
<i>Example:</i>	1Q	1Q	1.01	<i>With tagged response – verbose modes 2 and 3:</i> Ver01 * X11 ↵
Query verbose version information	0Q	0Q	Sum of responses from 2Q-3Q-4Q ↵	Show bootstrap, factory-installed, and updated firmware versions. (See 2Q, 3Q, and 4Q, on the following lines.)
<i>Example:</i>	0Q	0Q	1.00-0.00(1.48-MGP464 Series -Wed, 23 Jan 2003 18:37:59 GMT)-2.02* (1.66-MGP464 Series -Wed, 17 Oct 2007 17:50:01 GMT)	<i>With tagged response – verbose modes 2 and 3:</i> Ver00 * Sum of responses from 2Q-3Q-4Q ↵
Query bootstrap version	2Q	2Q	X11 ↵	The bootstrap firmware is not user-replaceable, but you may need this information for troubleshooting.
				<i>With tagged response – verbose modes 2 and 3:</i> Ver02 * X11 ↵
Query factory firmware version	3Q	3Q	X11 (plus web ver.-desc-UL date/time) ↵	Factory-installed firmware is not user-replaceable. This firmware was installed at the factory; it is the version the processor reverts to after a mode 1 reset (see chapter 3).
<i>Example:</i>	3Q	3Q	1.00(1.07-MGP464Series-Wed, 16 Jan 2006 03:28:10 GMT)	<i>With tagged response – verbose modes 2 and 3:</i> Ver03 * X11 (plus web ver.-desc-UL date/time) ↵
				In this example, the factory firmware version is 1.00, also known as the kernel version 1.07, for the MGP 464, dated 16 January, 2006.

Command/response table for IP SIS commands (continued)

Command	ASCII (Telnet) (host to processor)	URL Encoded (Web) (host to processor)	Response (Processor to host)	Additional description
Firmware version requests (continued)				
Query updated firmware version	4Q	4Q	[X11] (plus web ver.-desc-UL date/time) ↵	Use this command to find out which version of the firmware, if any, was uploaded into the unit after it left the factory. [X11] = firmware version to two decimal places.
<i>Example:</i>	4Q	4Q	<i>With tagged response – verbose modes 2 and 3:</i> Ver04 * [X11] (plus web ver.-desc-UL date/time) ↵ 2.02 * (1.66–MGP464 Series –Mon, 14 Jan 2008 17:03:46 GMT	In this example, the factory firmware version is 2.02, also known as kernel version 1.66, for MGP 464, dated 14 January, 2008, at 5:03 and 46 seconds p.m., Greenwich mean time.
Information requests				
Request unit part number	N	N	60-771-01 or 60-771-02 ↵	Show unit part number. MGP 464 is 60-771-01; MGP 464 DI is 60-771-02. <i>With tagged response – verbose modes 2 and 3:</i> Pno 60-771-01/60-771-02 ↵
Request model name	1I	1I	MGP 464 or MGP 464 DI ↵	Show unit model name. <i>With tagged response – verbose modes 2 and 3:</i> Inf01 * MGP 464 or Inf01 * MGP 464 DI
Request model description	2I	2I	Four Window Multi-Graphic Processor	Show type of unit. <i>With tagged response – verbose modes 2 and 3:</i> Inf02 * Four Window Multi-Graphic Processor
Request system memory usage	3I	3I	<i>n</i> bytes used out of <i>n</i> kBytes ↵	Show amount of memory used and total available memory for system operations. <i>With tagged response – verbose modes 2 and 3:</i> Inf03 * <i>n</i> bytes used out of <i>n</i> kBytes ↵
Request user memory usage	4I	4I	<i>n</i> bytes used out of <i>n</i> kBytes ↵	Show amount of user memory used and total available user memory. <i>With tagged response – verbose modes 2 and 3:</i> Inf04 * <i>n</i> bytes used out of <i>n</i> kBytes ↵

Command/response table for IP SIS commands (continued)

Command	ASCII (Telnet) (host to processor)	URL Encoded (Web) (host to processor)	Response (Processor to host)	Additional description
Event control				
Read event buffer memory ²⁷	<code>[Esc] X35, X36, X37, X38 E ←</code>	<code>W X35, X36, X37, X38 E </code>	<code>X54 ↵</code>	Read the contents of a specific section of a memory buffer for event number <code>X35</code> . <code>X35</code> = event number, 1 through 99. <code>X36</code> = event buffer. For x36: 0 = receive 1 = user 2 = NVRAM <code>X37</code> = event buffer offset, 0 to maximum buffer size. <code>X38</code> = Event data size. For x38: b = bit B = byte (8 bits) S = short (16 bits) L = long (32 bits) <code>X54</code> = data element value in ASCII from event buffer (leading zeros suppressed).
Write event to memory buffer ^{24 27}	<code>[Esc] X35, X36, X37, X39, X38 E ←</code>	<code>W X35, X36, X37, X39, X38 E </code>	<code>Ewr X35, X39 ↵</code>	Write event <code>X35</code> to buffer <code>X36</code> , offset by <code>X37</code> . Include data <code>X39</code> , size <code>X38</code> . <code>X39</code> = event data to write.
Read string from event buffer memory ²⁷	<code>[Esc] X35, X36, X37, X44 FE ←</code>	<code>W X35, X36, X37, X44 FE </code>	<code>{string} ↵</code>	Read string from event <code>X35</code> , buffer <code>X36</code> , offset by <code>X37</code> , <code>X44</code> bytes. <code>X44</code> = number of bytes to read.
Write string to event buffer memory ^{24 27}	<code>[Esc] X39, X35, X36, X37 FE ←</code>	<code>W X39, %2A X35, X36, X37 FE </code>	<code>Ewr X35, X39 ↵</code>	Write data string <code>X39</code> from event <code>X35</code> , buffer <code>X36</code> , offset by <code>X37</code> .

Command/response table for IP SIS commands (continued)

Command	ASCII (Telnet) (host to processor)	URL Encoded (Web) (host to processor)	Response (Processor to host)	Additional description
Event control (continued)				
Start events ^{24 27}	Esc 1AE ←	W 1AE	Ego ↵	Initiate all programmed events.
Stop events ^{24 27}	Esc 0AE ←	W 0AE	Est ↵	Stop all programmed events.
Read number of events running	Esc AE ←	W AE	Enm## ↵ With tagged response – verbose modes 2 and 3: Enm ##### ↵	## = 2-digit number Enm ##### = 5-digit number
E-mail				
Configure e-mail events ²⁴	X45 , X46 , X47 CR ←	W X45 , X46 , X47 CR	lpr X45 , X46 , X47 ↵	X45 = e-mail event number (1 through 64). X46 = e-mail recipient's address. X47 = name of e-mail file to be sent (first line of the file is the subject; the rest is the body of the e-mail).
<i>Example:</i>	Esc 5, jdoe@extron.com, 7.eml CR ←	W 5%2C jdoe %40 extron %2E xom %2C 7 %2E eml CR	lpr5, jdoe@extron.com, 7.eml ↵	For e-mail event 5, send file 7.eml to jdoe@extron.com.
View e-mail events	X45 CR ←	W X45 CR	X46 , X47 ↵	
Send e-mail (file named in mail box)	Esc X45 SM ←	W X45 SM	Eml X45 ↵	
Send e-mail (using a different file)	Esc X45 , X70 , X47 SM ←	W X45 %2C X70 %2C X47 SM ←	Eml X45 ↵	X70 = number inserted into the e-mail message if the .eml file has an embedded Esc ← command.
Web browser specific commands				
Read response from last URL command	Esc UB ←	W UB	Response from command ↵	

Command/response table for IP SIS commands (continued)

Command	ASCII (Telnet) (host to processor)	URL Encoded (Web) (host to processor)	Response (Processor to host)	Additional description
IP setup commands				
Set unit name ²⁴	Esc X12 CN ←	W X12 CN	Ipn • X12 ↵	Change the processor's name to X12 , a name of your choosing. For X12 : The name can consist of up to 24 alphanumeric characters (and the minus sign/hyphen). The first character must be a letter, the last character cannot be a minus sign. Case does not matter.
Set unit name to factory default ²⁴	Esc • CN ←	W %20 CN	Ipn • X49 ↵	X49 is the name the processor was shipped with: MGP464-##-##-##, a combination of the model name and the last three pairs of the hex numbers in the unit's MAC address (e.g., MGP464-00-02-3d).
Read unit name	Esc CN ←	W CN	X12 ↵	X12 is the processor's current name.
Set time/date ²⁴	Esc X13 CT ←	W X13 CT	Ipt • X13 ↵	X13 is the local date and time format. The set format is MM/DD/YY-HH:MM:SS. (The hours, minutes, and seconds can also be separated by periods.) <i>Examples: 11/13/06-10:54:00 or 11/13/06-10.54.00</i>
Read time/date	Esc CT ←	W CT	X13 ↵	The read format is <i>day of week, DD month year HH:MM:SS</i> . <i>Example: Tue, 18 Nov 2006 18:19:33</i>
Set GMT offset ²⁴	Esc X3 CZ ←	W X3 CZ	Ipz X3 ↵	Set the Greenwich Mean Time (GMT) offset value (X3) for the processor's location. GMT offset (-12.00 to +14.00) represents the time difference in hours and minutes (± hh:mm relative to Greenwich, England). The plus sign and leading zero are optional. X3 is in the format hh:mm. <i>Example: 5:30 or 5.30 = +05:30</i>
Read GMT offset	CZ ←	W CZ	X3 ↵	

Command/response table for IP SIS commands (continued)

Command	ASCII (Telnet) (host to processor)	URL Encoded (Web) (host to processor)	Response (Processor to host)	Additional description
IP setup commands (continued)				
Set daylight saving time ²⁴	Esc X34 CX ←	W X34 CX	Ipx X34 ↵	X34 is the daylight saving time of day. Daylight saving time (DST) is a one-hour offset that is observed in the USA and parts of Europe and Brazil. For X34 : 0 = off/ignore 1 = on in northern hemisphere 2 = on in Europe 3 = on in Brazil For example, California uses GMT -8:00 from April to October and -7:00 GMT from November to March. DST should be turned off in Hawaii, American Samoa, Guam, Puerto Rico, the U.S. Virgin Islands, and Arizona (excluding the Navajo Nation).
Read daylight saving time	Esc CX ←	W CX	X34 ↵	
Set DHCP on ²⁴	Esc 1DH ←	W 1DH	Idh1 ↵	
Set DHCP off ²⁴	Esc 0DH ←	W 0DH	Idh0 ↵	
View DHCP mode	Esc DH ←	W DH	Idh X5 ↵	X5 = DHCP on/off status: 0 = off; 1 = on.
Set IP address ²⁴	Esc X14 CI ←	W X14 CI	Ipi • X14 ↵	X14 = IP address (xxx.xxx.xxx.xxx). Leading zeros in each of the four fields are optional in setting values.
Read IP address ²⁴	Esc CI ←	W CI	X14 ↵	Leading zeros in each of the four fields are suppressed in returned values.
Read hardware address (MAC)	Esc CH ←	W CH	X18 ↵	X18 = hardware media access control (MAC) address (xx-xx-xx-xx-xx-xx).
Set subnet mask ²⁴	Esc X19 CS ←	W X19 CS	Ips • X19 ↵	X19 = subnet mask (xxx.xxx.xxx.xxx). Syntax is the same as for IP addresses. Leading zeros are optional in setting values.
Read subnet mask	Esc CS ←	W CS	X19 ↵	Leading zeros are suppressed.
Set gateway address ²⁴	Esc X14 CG ←	W X14 CG	Ipg • X14 ↵	X14 = IP address (xxx.xxx.xxx.xxx). Leading zeros are optional.
Read gateway address	Esc CG ←	W CG	X14 ↵	

Command/response table for IP SIS commands (continued)

Command	ASCII (Telnet) (host to processor)	URL Encoded (Web) (host to processor)	Response (Processor to host)	Additional description
IP setup commands (continued)				
Set administrator password	Esc X33 CA ←	W X33 CA	Ipa • X41 ↵	Set administrator access password X33 . X33 = 4 to 12 alphanumeric characters. The password is case sensitive. Special characters (spaces or symbols) are not allowed. X41 = password displayed as four asterisks (****).
Clear administrator password ²⁴	Esc • CA ←	W %20 CA	Ipa • ↵	Clear/remove all passwords (administrator and user). NOTE A user password cannot be assigned if an administrator password does not exist. Entering a password when the MGP 464 has not been configured yields an E14 error response from the processor. If the administrator password is cleared (removed), the user password is removed also.
View administrator password	Esc CA ←	W CA	X41 ↵	View password level X41 , shown with leading zeros.
Set user password ^{14,24}	Esc X33 CU ←	W X33 CU	Ipu • X41 ↵	Set user password X33 (4-12 alphanumeric characters). The password is case sensitive. Special characters (spaces or symbols) are not allowed. NOTE A user password cannot be assigned if an administrator password does not exist.
Clear user password ²⁴	Esc • CU ←	W %20 CU	Ipu • ↵	Clear the user password only.
View user password	Esc CU ←	W CU	X41 ↵	View password level X41 , shown with leading zeros.
Set extended level password ²⁴	Esc X51 , X33 CO ←	W X51 %2C X33 CO	Ipo X51 • X41 ↵	Set password X33 for security level X51 . X51 = 1 through 10.
Clear extended level password ²⁴	Esc X51 , CO ←	W X51 %2C CO	Ipo X51 • ↵	Remove password from security level X51 .
View extended level password	Esc X51 CO ←	W X51 CO	X41 ↵	View password level X41 , shown with leading zeros.
Set read-only security level support ²⁴	Esc X66 * X68 EP ←	W X66 %2A X68 EP	Pvo X66 * X68 ↵	Enable no-password login at security level X68 . For X66 : 0 = no-password logon disabled 1 = no-password logon enabled For X68 : 0 = no-password logon is placed one level below the lowest existing password level (0 through 11). 1 through 11 = no-password logon enabled at the level specified if an admin. password exists.

Command/response table for IP SIS commands (continued)

Command	ASCII (Telnet) (host to processor)	URL Encoded (Web) (host to processor)	Response (Processor to host)	Additional description
IP setup commands (continued)				
View read-only security level support ²⁴	Esc EP ←	W EP	X66 * X68 ↵	View status and level of no-password security.
Query session security level	Esc CK ←	W CK	X52 ↵	View the security level X52 of the current connection. For X52 : 0 = Anonymous 1-10 = Extended security level 11 = User 12 = Administrator
			With tagged response – verbose modes 2 and 3: Pvl X52 ↵	
Set Verbose mode ²⁴	Esc X22 CV ←	W X22 CV	X22 ↵	Enable or disable verbose mode type X22 . For X22 : 0 = clear/none 1 = verbose mode 2 = tagged responses for queries 3 = mode and tagged responses for queries. Default is 0 for Telnet connections and 1 for RS-232/422 control.
NOTE The processor can send out unsolicited information (such as notice of a change in volume, input or some other setting). That is called a verbose (wordy) relationship between the processor and a connected device. For a direct RS-232/422 connection, the processor is set for verbose mode by default. When the MGP 464 is connected via Ethernet, verbose mode is disabled by default in order to reduce the amount of communication traffic on the network. If you want to use the verbose mode with a processor connected via Ethernet, this mode must be set to On each time you reconnect to the processor.				
Read verbose mode	Esc CV ←	W CV	X22 ↵	
Read connection's security level	Esc CK ←	W CK	X52 ↵	
			With tagged response – verbose modes 2 and 3: Pvl X52 ↵	
Re-map port designations				
Set Telnet port map ²⁴	Esc {port#} MT ←	W {port#} MT	Pmt {port#} ↵	
Reset Telnet port map ²⁴	Esc 23MT ←	W 23MT	Pmt 00023 ↵	
Disable Telnet port map ²⁴	Esc 0MT ←	W 0MT	Pmt 00000 ↵	
Read Telnet port map	Esc MT ←	W MT	{port#} ↵	
Set Web port map ²⁴	Esc {port#} MH ←	W {port#} MH	Pmh {port#} ↵	
Reset Web port map ²⁴	Esc 80MH ←	W 80MH	Pmh 00080 ↵	

Command/response table for IP SIS commands (continued)

Command	ASCII (Telnet) (host to processor)	URL Encoded (Web) (host to processor)	Response (Processor to host)	Additional description
Re-map port designations (continued)				
Disable Web port map ²⁴	Esc 0MH ←	W 0MH	Pmh 00000 ↵	
Read Web port map ²⁴	Esc MH ←	W MH	{port#} ↵	
Set Direct Access port map ²⁴	Esc {port#} MD ←	W {port#} MD	Pmd {port#} ↵	
Reset Direct Access port map ²⁴	Esc 2001MD ←	W 2001MD	Pmd 02001 ↵	
Disable Direct Access port map ²⁴	Esc 0MD ←	W 0MD	Pmd 00000 ↵	
Read Direct Access port map ²⁴	Esc MD ←	W MD	{port#} ↵	
Listing connections				
Get connection listing	Esc CC ←	W CC		<i>Number of connections</i>
File commands				
List files from current directory	Esc DF ←	W DF	(See below.)	Retrieve a list of files stored in the MGP 464.
List files from current directory and below	Esc LF ←	W LF	(See below.)	Each line of the response lists a different file name and its corresponding file size. The last line of the response indicates how much available file space remains.
	Unit Telnet text responses:		Unit Web responses (HTML sample code):	
	filename x • date/time • length ↵		var file – new Array ();	
	filename x • date/time • length ↵		file [1] = "filename 1, date 1, filesize 1";	
	filename x • date/time • length ↵		file [1] = "filename 2, date 2, filesize 2";	
	filename x • date/time • length ↵		file [1] = "filename 3, date 3, filesize 3";	
	
	space_remaining • bytes left ↵ ↵		file [n] = "filename n, date n, filesize n";	
			file [1] = "filename n+1, date n+1, filesize n+1";	
Stream files via port 80				
Load file to user flash memory	Use POST on port 80 followed by the delimited data to be written to the flash file memory.			
Retrieve file from user flash memory	Send a page GET on port 80 followed by: WSF		Responds with raw unprocessed data in file.	
<i>Example</i>	http://192.168.254.254/mypage.html?cmd=WSF			
Stream files via Telnet or RS-232				
Load file to user flash memory	Esc + UF <i>filesize, filename</i> ←	{Raw unprocessed data in file up to filesize}		
		Up1 ↵		
Retrieve file from user flash memory	Esc <i>filename</i> SF ←	1B <i>filename</i> 53 46 0D	Responds with 4 bytes of file size + raw unprocessed data in file.	

Command/response table for IP SIS commands (continued)

Command	ASCII (Telnet) (host to processor)	URL Encoded (Web) (host to processor)	Response (Processor to host)	Additional description
Mail server setup commands				
Set mail server IP, unit domain name ²⁴	Esc X14, X15 CM ←	W X14 %2C X15 CM	Ipm • X14, X15 ←	X14 = IP address, format xxx.xxx.xxx.xxx. X15 = mail domain name.
Read mail server IP, unit domain name ^{24 28}	Esc CM ←	W X14 %2C X15 CM	X14, X15 ←	
Directory commands				
Change/create directory	Esc {path} / {directory}/CJ ←	W {path} / {directory}/CJ	Dir • {path} / {directory} / ←	
NOTE A directory does not actually exist until a file has been copied into the path.				
Move back to root directory	Esc / CJ ←	W %2F CJ	Dir • / ←	
Move up one directory	Esc .. CJ ←	W %2E %2E CJ	Dir • {path} / {directory} / ←	
View current directory	Esc CJ ←	W CJ	{path} / {directory} / ←	
Reset (Zap) / Erase commands				
Erase user-supplied Web page/file ^{24 28}	Esc {filename} EF ←	W {filename} EF	Del • {filename} ←	
Erase current directory and its files ^{24 28}	Esc / EF ←	W / EF	Ddl ←	
Erase current directory and subdirectories ^{24 28}	Esc // EF ←	W // EF	Ddl ←	
Erase flash memory	Esc ZFFF ←	W ZFFF	Zpf ←	
Reset all device settings to factory default ²⁴	Esc ZXXX ←	W ZXXX	Zpx ←	No IP-related settings are reset.
Absolute system reset ²⁴	Esc ZQQQ ←	W ZQQQ	Zpq ←	Reset all settings/memories, including all adjustments, the IP address, and the subnet mask, to the factory default values. The IP address is reset to 192.168.254.254, and the subnet mask is set to 255.255.0.0 (identical to reset mode 5).
Absolute reset retaining IP ²⁴	Esc ZY ←	W ZY	Zpy ←	Same as Absolute system reset (EZQQQ) except that IP settings, including IP address, subnet mask, gateway address, unit name, DHCP setting, and port mapping (Telnet/ Web/Direct Access) are excluded in order to preserve communication with the device. (Recommended after a firmware update.)

Software Configuration and Control, cont'd

Windows®-based Control Software

The MGP 464 Windows-based control software program provides a convenient way to configure the inputs, output, windows, and images in each window. It also lets you save and recall input and window presets, and perform nearly all the other functions that can be accomplished via the front panel controls, the SIS commands, or the MGP 464 Web pages.

Using the software, you can do the following types of tasks to configure your MGP:

Input configuration — Specify a name; video signal type; size in pixels of the active video area; horizontal/vertical start points of the total video display area; and each window's pixel sampling points (pixel phase) for each of the 19 inputs.

Output configuration — Set output resolution, refresh rate, sync polarity, and signal type (RGBHV, RGBS, RGsB, or YUV bi-level and tri-level); select a test pattern; and enable/disable blue mode in order to set video color and tint levels.

Picture controls — Position and size the four windows and the images within the windows, zoom in or out on the images/windows, and make fine adjustments to contrast, brightness, color, tint, and detail.

Presets — Create, save, and recall window and input presets.

Window configuration — Set window priority; border color; text label colors, size, and location; and transition effects for each window of the display.

Background capture — Capture the entire display on the output screen and save it as a bitmap, to be recalled and used as a window background when needed.

Installing the software

The MGP 464 configuration software is provided on a CD that is delivered with your MGP 464 unit. To use the software, you must install the program on your PC. Follow these steps:

1. Insert CD ROM Disk B into your CD drive. The disk should start automatically. If it does not, open your Windows Explorer and double-click LAUNCH.EXE on the CD drive to start it.
2. On the Software Products Disk B screen (shown on the next page), click the **Software** button.



Extron Electronics Extron Software Products Disc B: Issue 2008.1 800.633.9876

Products Software Manuals Home extron.com Contact Us

<click to select product>

List Part Numbers

What's New Since Last Issue

 www.extron.com
For the latest product information, visit www.extron.com

Extron Software Products Disc B: Issue 2008.1

For more than 20 years, Extron Electronics has manufactured professional A/V system products, including computer-video interfaces, switches, matrix switches, distribution amplifiers, signal processing devices, Ethernet control interfaces, and high resolution cable. Extron offers solutions for integration of video and audio into presentation systems for a variety of environments, such as boardrooms, classrooms and training centers, lecture halls, command and control centers, and more.



Products
Find a product, and view available files.



Software
Install control and configuration software.

Get viewers & utilities here



DirectX
DirectX is a Windows technology that enables higher performance in graphics and sound on your PC. Required for use with IP Intercom HelpDesk software. [Install it now](#)



Microsoft .NET Framework
The .NET Framework runtime and associated files are required to run applications developed to target the .NET Framework v2.0. Required for use with IP Intercom HelpDesk software. [Install it now](#)



Acrobat Reader
Adobe® Acrobat® Reader™ is a free download that is necessary for viewing PDF ("Portable Document Format") files. Extron files offered in this format include the catalog pages, brochures, user manuals, and product specifications. [Install it now](#)



JS Installer 5.6
This is the updated JavaScript engine for Windows that is needed for correct operation of Global Viewer and must be loaded on any client machines that plan to access the application. [Install it now](#)

Visit www.extron.com to check for updates.
requires internet connection

Link to the installation software on the MGP 464 CD

- In the table on the Control Software screen, scroll to locate the MGP 464, and click the **Install** link in the far right column.

<ul style="list-style-type: none"> MGP 464 Control Software for the MGP 464 and MGP 464 DI. Release Notes 	79-518-01	1.2	Jul 5, 2006	8.9 MB	Install
---	-----------	-----	-------------	--------	-------------------------

- On the File Download window that appears, click **Run** to begin installing the program.

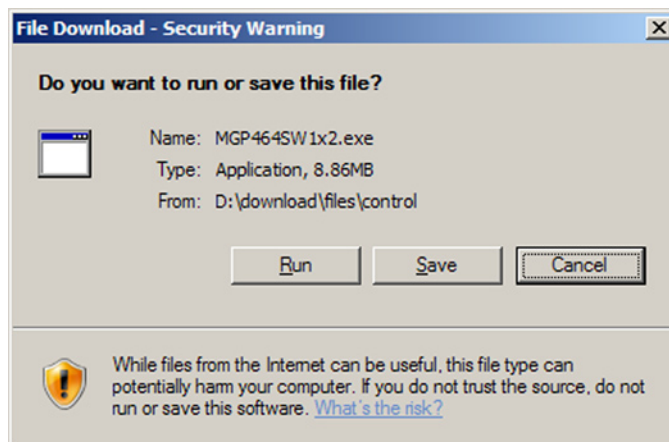

File Download window

Software Configuration and Control, cont'd

If you want to save the installation file (MGP464Setupv*n_n*.exe) to your desktop to run later, click **Save** instead of **Run**. On the Save As window, save the setup file to the desired location on your PC. When you are ready to install the software, double-click on the **MGP464SW1xn.exe** icon, click Run on the Security prompt, and restart the procedure at step 4.

5. Another Security prompt appears. Click **Run** on this window to continue with the installation.
6. Follow the instructions on the InstallShield Wizard screens to complete the program installation.

By default the installation creates a folder called "MGP464" in the following location on your computer:

c: \Program Files\Extron\MGP464

If there is no Extron folder in your Program Files folder, the installation program creates it as well.

7. When installation is complete, close the Software Products screen. You can now start the Windows-based control program.

Downloading the MGP 464 software from the Web

The MGP 464 Windows-based control program is also available on the Extron Web site at www.extron.com. From this site, you can also download updates to the MGP software as they become available.

To access the software on the Web,

1. Open the Extron Web page, and select the Download tab.
2. On the Download Center screen, click the **Control Software** button (shown at right). A Control Software screen is displayed, containing a list of control software products.
3. In one of the linked alphabets displayed across the top and bottom of the screen, click **M**.
4. On the "M" software products page, scroll to locate MGP 464, and click the **Download** link at the far right.
5. On the next screen, fill in the required information.
6. Click the **Download MGP464SW1xn.exe** button.
7. On the File Download - Security Warning window that appears, click **Run** to begin downloading the installer file.



If you want to save the installation file (MGP 464WSetupv1_*n*.exe) to your computer hard drive to run later, click **Save**. On the Save As window that opens, save the setup file to the desired location. When you are ready to install the software, double-click on the **MGP464SW1xn.exe** icon, click **Run** on the download screen that opens, and restart this procedure at step 8.

8. On the second security prompt window that opens, click **Run** again to start the installation process.
9. Follow the instructions on the InstallShield Wizard screens to complete the software program installation. By default the installation creates a folder called "MGP464" in the following location on the computer:

c: \Program Files\Extron\MGP464

If there is no Extron folder in your Program Files folder, the installation program creates it as well.

Starting the control program

The MGP 464 software help program provides information on settings and on how to use the control program itself.

1. To run the MGP 464 configuration program, do either of the following:
 - Double-click on the MGP464.exe file, located on your computer at c: \Program Files\Extron\MGP464.
 - Access the program from the Start menu on your computer as follows:
 - a. Click **Start** on your computer screen.
 - b. Select **All Programs** from the Start menu.
 - c. From the All Programs menu, select **Extron Electronics**.
 - d. From the Extron Electronics menu, select **MGP 464**.
 - e. Select **MGP 464 Control Program**.

The Communication Type Selection window appears.

2. On the Communication Type Selection window, select the tab for the communication method you want to use between your computer and the MGP 464.

NOTE Most items in the MGP 464 control program can also be configured via the front panel, or via the MGP 464 Web site. (Virtual inputs 5 through 19 *cannot* be configured from the front panel.) For details on features and settings, see chapter 3, "Operation," to configure via the front panel, or chapter 4, "SIS Configuration and Control," to configure using the Web pages.

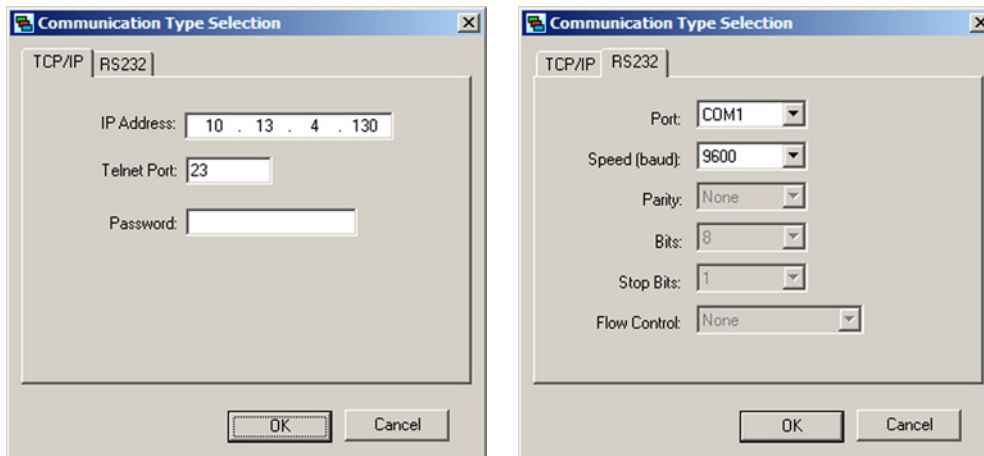

Comm Port Selection window with TCPIIP and RS232 tabs

- Select TCP/IP if you are using the LAN port.

NOTE If you will be uploading firmware, you should use this connection.

- Select RS232 if you are using either of the serial ports. (The front panel TRS configuration port supports only RS-232. The 9-pin rear panel serial port supports both RS-232 and RS-422 .

Software Configuration and Control, cont'd

3. On the selected tab, enter the information required for the type of communication you chose.
 - **TCP/IP:** Enter your MGP's IP address, Telnet port (the default is 23), and a password if desired.
 - **RS-232/422:** Select your PC's communication port from the Port menu, and the baud rate from the Speed menu. All other parameters are preset.
4. Click **OK**. After a few seconds, the MGP 464 main window opens.

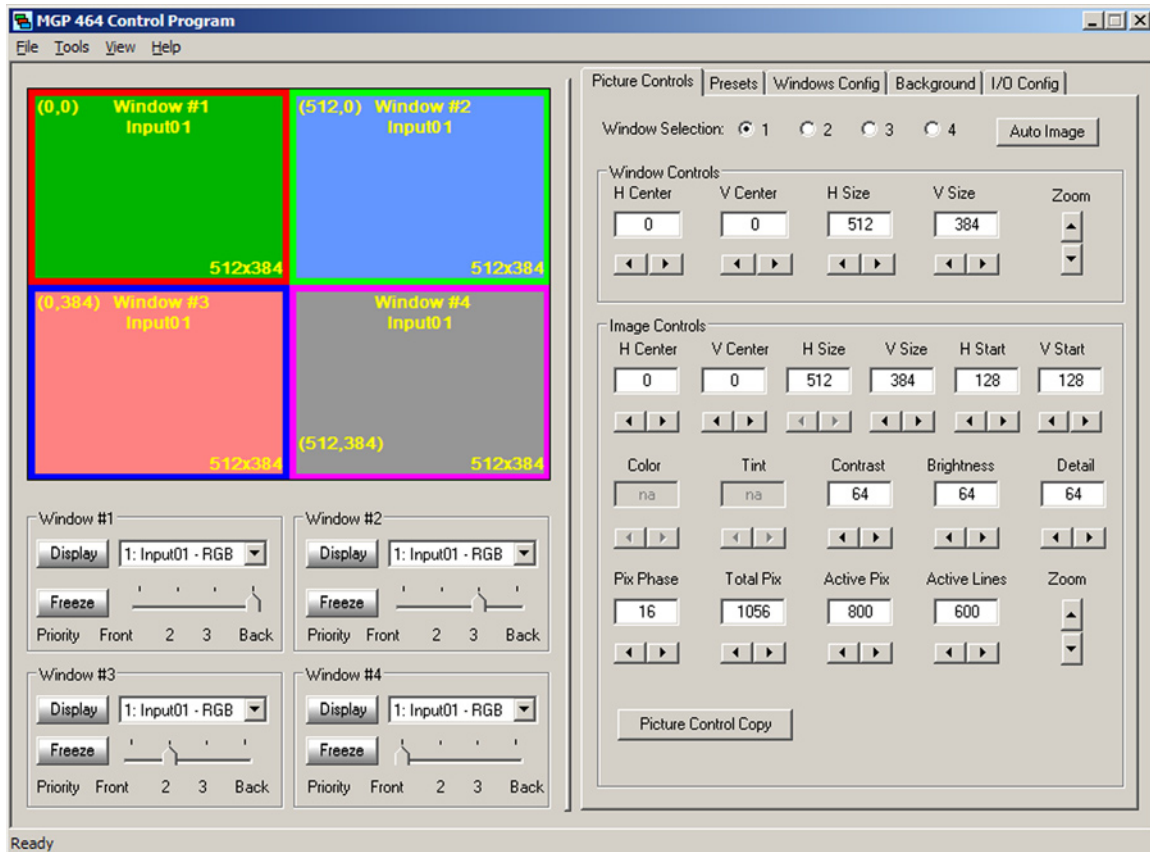

MGP 464 window

5. For information on configuring the MGP 464 using the Windows-based software, refer to the program's help file. To access the help file, select **Contents** from the Help pull-down menu, or press the F1 key.



MGP 464 Multi-Graphic Processor

5 Chapter Five

HTML Configuration and Control

Accessing the Web Pages

Viewing System Status

Using the Configuration Page

Using the File Management Page

Using the Control Page

Using the Background Page

HTML Configuration and Control

The MGP 464 can be controlled and configured using HTML Web pages accessed over a network or from a local PC connected to the MGP 464's LAN port. The MGP 464 has factory-installed HTML Web pages that allow you to select and configure inputs, adjust picture controls, configure windows, save and recall presets, and perform other processor functions. Access these HTML pages using a Web browser such as Microsoft Internet Explorer.

NOTE Administrators have access to all of the Web pages and are able to make changes to settings. Users can access the pages on the System Status, Control, and Background tabs only.

Accessing the Web Pages

To access the MGP 464's HTML Web pages:

1. Start the Web browser program.
2. Enter the MGP 464's IP address in the browser's Address field.

NOTE If your local system administrators have not changed the address, use the factory-specified default, **192.168.254.254**, for this field.

3. If you want the browser to display a page other than the default page (such as a custom page that you have created and uploaded), enter a slash (/) and the name of the file to open.

NOTE The browser's Address field should display the address in the following format:
`xxx.xxx.xxx.xxx/{optional_file_name.html}`

NOTE The following characters are invalid in file names:
{space} ~ @ = ' [] { } < > ' " ; : | \ and ?.

4. Press the Enter key. If the MGP 464's HTML pages are not password protected, the browser displays a start page as described in step 5.

If the MGP 464's HTML pages are password protected, the browser displays the Enter Network Password dialog box.

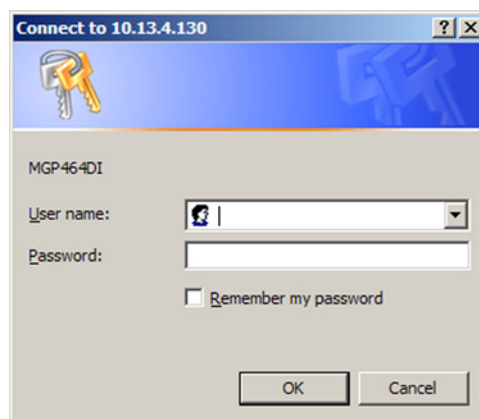

Example of an Enter Network Password dialog box

- a. Enter the administrator or user password in the Password field.

NOTE A User Name entry is not required.

- b. If desired, select the **Remember my password** check box to have the system input your password the next time you enter the IP address.
- c. Click **OK**.

- If you entered the filename for a custom HTML page in step 4, the browser displays that page. If not, the browser displays the System Status page, which is the MGP 464's default start page. You can select the tabs at the top of this screen to display additional screens that enable you to configure and operate the MGP 464.

Viewing System Status

The System Status Web page on the Status tab provides information on your MGP 464's current settings. Changes must be made via the Configuration Web pages, the MGP 464 Windows-based configuration software, SIS commands, or the MGP 464 front panel. Personnel who have user access can view this page but cannot access the Configuration pages; they see only the Status, Control, and Background tabs. The following figure shows a typical MGP 464 System Status Web page.

The screenshot displays the Extron Electronics System Status web page. The page has a blue header with the Extron logo and navigation tabs: Status, Configuration, File Management, Control, and Background. The user is logged in as Admin. The main content area is titled "System Status" and includes a description of the unit's current settings. The settings are organized into three sections: System Description, IP Settings, and Serial Port Settings.

System Description			
Model:	MGP464DI		
Description:	Multi-Graphic Processor w/ DVI option		
Part Number:	60-771-02	Firmware Version:	1.00
Date:	2/09/2006	Temperature:	098.60 F / 37.00 C
Time:	11:25 AM	# of Connections:	002

IP Settings	
Unit Name:	MGP464DI-00-C1-A5
DHCP:	Off
IP Address:	10.13.4.130
Gateway IP Address:	10.13.0.100
Subnet Mask:	255.255.0.0
MAC Address:	00-05-A6-00-C1-A5

Serial Port Settings			
Port:	1	Port:	2
Port Type:	RS-232	Port Type:	RS-232
Baud Rate:	9600	Baud Rate:	9600
Data Bits:	8	Data Bits:	8
Parity:	None	Parity:	None
Stop Bits:	1	Stop Bits:	1
Flow Control:	None	Flow Control:	None

System Status screen

HTML Configuration and Control, cont'd

Using the Configuration Page

There are six Configuration Web pages, which only administrators can access. These pages are listed in the sidebar menu at the left of the Configuration screen. The following sections describe the changes you can make from these screens.

System Settings screen

On the System Settings screen (shown below), you can set date and time parameters, and change the IP information for the MGP 464.

The screenshot shows the Extron Electronics System Settings web interface. The top navigation bar includes tabs for Status, Configuration, File Management, Control, and Background. The user is logged in as Admin. The sidebar menu on the left lists System Settings, Scaler I/O Settings, Window Settings, Passwords, Email Alerts, and Firmware Upgrade. The main content area is titled "System Settings" and contains two sections: IP Settings and Date/Time Settings. The IP Settings section includes fields for Unit Name (MGP464DI-00-C1-A5), DHCP (On/Off), IP Address (10.13.4.130), Gateway IP Address (10.13.0.100), Subnet Mask (255.255.0.0), MAC Address (00-05-A6-00-C1-A5), Firmware (0.00), Model (MGP464DI), and Part Number (60-771-02). The Date/Time Settings section includes fields for Date (2/9/2006), Time (12:02 PM), Zone ((GMT-08:00) Pacific Time (US & Canada), Tijuana), and Daylight Saving (USA). Both sections have Submit and Cancel buttons.

System Settings screen

To change your system settings,

1. On the Configuration tab, select **System Settings** from the sidebar menu at the left edge of the screen.
2. Select or enter the new information in the desired field(s) in either the IP Settings or the Date/Time Settings section.
3. When you have made all the desired inputs in one section, click the **Submit** button at the bottom of the section. The new settings appear in the fields.
4. Follow steps 2 and 3 to make changes in the other section, if needed.

Scaler I/O Settings screen

On the Scaler I/O Settings screen (shown below), you can specify configuration settings for the 4 fully configurable inputs, the 15 virtual inputs, and the output. You can also select a test pattern and enable or disable blue mode.

The screenshot shows the Extron Electronics MGP464DI Scaler I/O Settings screen. The interface is divided into several sections:

- Fully Configurable Inputs:** Four input boxes (Input01-04) with RGB color selection and Film Mode checkboxes.
- Virtual Inputs:** A table with columns for BNC#, Input Names, and Film Mode, listing 15 inputs (Input05-19) with checkboxes and dropdown menus for video signal types like YUVi, S-Video, and Comp.
- Output Configuration:** Settings for Resolution (DVI Background), Refresh Rate (N/A), Test Patterns (1.78 Aspect Ratio), Sync Format (YUV Tri-Level), Polarity (H- V+), and Blue Screen Mode (Off/On).

Scaler I/O Settings screen

Configuring the inputs

The Input Configuration section of the Scaler I/O Settings screen lets you name, enable and disable film mode for 3:2 and 2:2 pulldown, and select the video signal type for each of the 19 available inputs.

Naming inputs

You can assign names to the inputs using the input name boxes located beneath each input number. The name in this box is displayed on the screen as a text label in the window, unless you specify otherwise. (See "Window Settings screen," later in this chapter.)

Initially, a default name is displayed in each box:

Input##

NOTE If you select a virtual input that actually consists of two inputs (S-video) or three inputs (YUVi), only the first input number of the set is displayed in the window.

For example, if inputs 5, 6, and 7 have been configured together as a YUVi input, only 5 appears as the input number on the screen.

HTML Configuration and Control, cont'd

To change the name of an input,

1. On the Scaler I/O Settings screen, select and delete the text in the box under the desired input number.
2. Enter a name of up to 16 characters for the input. The following characters may be used:

Symbols: : / - _ + “

Numerals: 0 through 9

Letters: Lowercase a through z, uppercase A through Z

Spaces also can be used.

Selecting the video signal type

Under each input name box is a pull-down menu from which you can select the video signal type for the input.

Signal type — RGB, YUV-HD, RGBcVs, DVI (MGP 464 DI and MGP 464 HD-SDI only), or HD-SDI (MGP 464 HD-SDI only) are available on inputs 1 through 4 only. YUVi component video, S-video, and composite video are available on all inputs.

The virtual inputs (5 through 19) are displayed on the screen in groups of three, with one drop-down menu for each set of three inputs.

For each virtual input group,

- If you select **YUVi** from the menu, all **three** inputs in the group are configured together as one component video input.
- If you select **S-Video,Comp**, the first (top) **two** inputs are configured as S-video and the third, as composite.
- If you select **Comp,Comp,Comp**, each input in the group is configured as composite video.

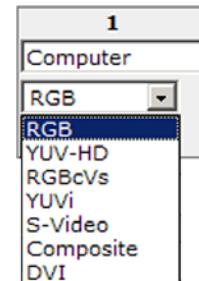

BNC#	Input Names	Film Mode
11	Input11	<input checked="" type="checkbox"/>
12	Input12	<input checked="" type="checkbox"/>
13	Input13	<input checked="" type="checkbox"/>
	YUVi	<input type="checkbox"/>
	YUVi	<input type="checkbox"/>
	S-Video, Comp	<input type="checkbox"/>
	Comp, Comp, Comp	<input type="checkbox"/>

Film mode — To place an input in film mode, which enables 3:2 and 2:2 pull-down, select the Film Mode check box below or to the right of the signal type menu. If RGB, YUV-HD, DVI, or HD-SDI is selected as the signal type, this check box is unavailable.

Configuring the output

In the Output Configuration section of the Scaler I/O Settings screen, you can select output parameters from the following pull-down menus:

Resolution — Select the resolution at which the image is displayed on the output screen.

Refresh Rate — Select the rate in Hz at which the output screen is refreshed.

Sync Format — Select the output signal type required by the display device. Available formats are RGBHV, RGBS, RGSB, YUV bi-level and YUV tri-level.

Polarity — Select the combination of horizontal and vertical synchronization signal polarities.

Test pattern — You can select one of the test patterns shown below to adjust the display for color, convergence, focus, resolution, contrast, grayscale, and aspect ratio.



Colorbars (8)

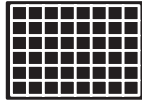

X-Hatch
(16x12)

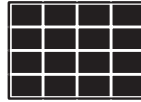

4x4 X-Hatch



Grey Scale



Ramp



Alt. Pixels



White Field



Crop



Side-By-Side
(4x3 crop)



Side-By-Side
(16x9 crop)



Quad Split

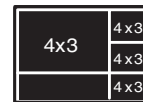

PIP Images
(4x3)

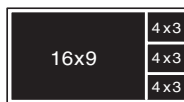

PIP Images
(16x9)



1.78 Aspect



1.85 Aspect



2.35 Aspect

Test patterns available on the MGP 464

Enabling/disabling blue mode

In the Blue Screen Mode section, select the **Off** or **On** radio button to disable or enable blue mode. When you enable blue mode, only the sync and blue video signals are passed to the display. This helps in setting up the color and tint.

HTML Configuration and Control, cont'd

Window Settings screen

The Window Settings screen, shown below, enables you to specify various parameters for windows 1, 2, 3, and 4.

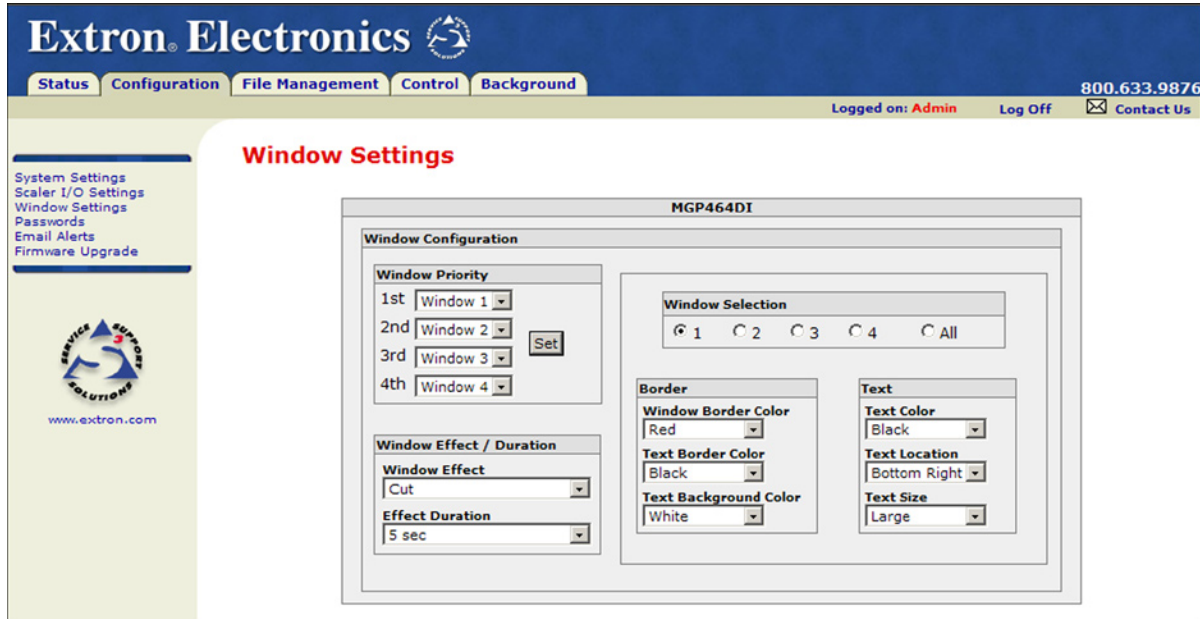

Window Settings screen

The following fields are provided:

Window Selection — Select one of the window radio buttons in this section to specify the window for which you are changing parameters. The **All** button selects all the windows, enabling you to quickly specify the same parameters for all four of the windows.

Window Priority — In this section you can set how the windows overlap one another or “stack” on the display. For example, the window with priority 1 is displayed in front of (on top of) all the other windows. (If it is sized to fill the screen, the other windows are not visible.) If the window with priority 1 is closed, the window with priority 2 is displayed in front, overlapping or covering the others.

See “Setting window priority,” on the next page, for instructions on using this section.

Window Effect/Duration — From the Window Effect pull-down menu in this section, select a transition effect to be used when windows are muted (closed) or unmuted (opened). See “Available effects,” in the “Window Configuration menu” section of chapter 3, “Operation,” for a description of the available transition effects.

From the Effect Duration menu in this section, select the amount of seconds that the MGP takes to complete a transition (displaying the transition effect on the output screen) when muting or unmuting a window.

NOTE If you select **Cut** from the Window Effect menu, any selection from the Effect Duration menu is ignored.

Border — In this section you can make selections from the following menus to specify parameters for the text label or for the border on the selected window. You can specify a different color for each window if desired.

Window Border Color: Select a color for the border around the entire window display. The defaults are **Red**, **Green**, **Blue**, and **Magenta** for windows 1, 2, 3, and 4, respectively. **Off** specifies that there is no window border.

Text Border Color: Select a color for the border surrounding the text label. The default is **Black**.

Text Background Color: Select a color for the text label background. The default is **White**.

- **Off** specifies that there is no special background for the text label; only the window background is behind the text. (The window background is specified from the Advanced Configuration menu.)
- **Translucent** specifies that the window background shows through the text background with a cloudy effect.

Text — In this section you can make selections from the following menus to specify parameters for the label text in the selected window.

Text Color: Select a color for the text in the label displayed in the window. The default is **Black**.

Text Location: Select the area on the screen in which a text label is displayed on all windows. The default is **None**, which specifies that no text label is displayed.

Text Size: Select **Small**, **Medium**, or **Large** for the size of the text label on the selected window.

Setting window priority

The Window Priority section of the Window Settings screen lets you set the priority for each of the four windows individually. Follow these steps to set window priority:

1. From the "1st" pull-down menu in the Window Priority section, select the window to which you want to give first priority. The window that you select here covers or overlaps all the other windows on the screen unless it is muted.
2. From the "2nd," "3rd," and "4th" menus, select the window to which you want to assign second, third, and fourth priority, respectively.
3. When finished selecting from the priority menus, click **Set** to establish your priority selections.

NOTE *If you assign the same window two priorities, your selections are not implemented when you click **Set**, and the priority fields return to their previous selections.*

HTML Configuration and Control, cont'd

Passwords screen

The Passwords screen lets you assign an administrator and/or user password to control access to the MGP 464 Web pages.

NOTE An administrator password must be in place before a user password can be assigned.

NOTE Passwords must contain 4 to 12 alphanumeric characters. Symbols and spaces are not allowed, and the passwords are case sensitive.

The screenshot shows the Extron Electronics web interface. The top navigation bar includes 'Status', 'Configuration', 'File Management', 'Control', and 'Background'. The 'Control' tab is active. The page title is 'Passwords'. The main content area contains the following text:

To update the Administration Password, enter the desired password, repeat the entry, and press 'Submit'. To update the User Password, enter the desired password, repeat the entry, and press 'Submit'. To clear a password, enter a single space, repeat the entry, and press 'Submit'. Minimum password length is 4 characters. Maximum password length is 12 characters. Passwords are case sensitive and special characters are not allowed.

The form below has the following fields:

- Administrator Password: [password field]
- Re-enter Admin Password: [password field]
- User Password: [password field]
- Re-enter User Password: [password field]

Buttons: [Submit] [Cancel]

Passwords screen

Assigning a password

To assign passwords,

1. Enter the new administrator password in the Administrator Password field.
2. In the Re-enter Admin Password field, enter the same password again to confirm it.
3. If you want to assign a user password, enter it in the User Password field.

NOTE You cannot assign a user password unless an administrator password has been assigned.

4. Reenter the same user password in the Re-enter the User Password field.
5. Click the **Submit** button to set the password(s).

Clearing a password

To remove an assigned password,

1. In the Administrator Password or User Password field, enter a single space.
2. Enter a single space in the Re-enter Admin Password or the Re-enter User Password field.
3. Click the **Submit** button.

Email Alerts screen

The Email Alerts screen enables you to set up the MGP 464 to automatically send e-mail alert messages when any of its settings are changed. You can enter up to 64 e-mail addresses to alert recipients that an event has occurred.

You can also specify that SMTP (Simple Mail Transfer Protocol) authorization is needed for the MGP to accept incoming e-mail. This prevents spam from taking up space in the MGP's e-mail system.

Extron Electronics

Status Configuration File Management Control Background

Logged on: Admin Log Off Contact Us 800.633.9876

Email Alerts

The settings below will allow you to configure your unit to send email alerts. Click 'Edit' and enter the email address to send a message to, and the file name that contains the message. File names must be alpha-numeric and are limited to 7 characters including the .eml file extension. Click 'Save' to save the change.

Email Settings

Mail IP Address:

Domain Name:

SMTP Authentication Required

User Name:

Password:

	Email Address	File Name	
1.	<input type="text"/>	<input type="text"/>	<input type="button" value="Edit"/>
2.	<input type="text"/>	<input type="text"/>	<input type="button" value="Edit"/>
3.	<input type="text"/>	<input type="text"/>	<input type="button" value="Edit"/>
4.	<input type="text"/>	<input type="text"/>	<input type="button" value="Edit"/>
5.	<input type="text"/>	<input type="text"/>	<input type="button" value="Edit"/>
6.	<input type="text"/>	<input type="text"/>	<input type="button" value="Edit"/>
7.	<input type="text"/>	<input type="text"/>	<input type="button" value="Edit"/>
8.	<input type="text"/>	<input type="text"/>	<input type="button" value="Edit"/>

Email Alerts screen (top portion)

Setting up e-mail alerts

To set up the system to send e-mail alerts when MGP settings are changed,

1. On the sidebar menu on the Configuration tab, click **Email Alerts**.
2. On the Email Alerts screen, click the **Edit** button located to the right of the Mail IP Address and Domain Name fields. The button changes to **Save**.
3. Enter your MGP 464's IP address and your domain name in the appropriate fields. (This information is available from your network administrator.)
4. If your MGP has a password assigned, enter it.
5. Click the **Save** button.

To set up e-mail addresses for notification, do the following for each recipient:

1. Click the **Edit** button at the right end of the address row. The **Edit** button changes to **Save**.
2. Enter the e-mail address of the recipient, and the file name on your computer (.eml extension) that contains the message.
3. Click the **Save** button to save the changes. The **Save** button changes to **Edit**.

HTML Configuration and Control, cont'd

Setting up SMTP authorization

To set the MGP to require SMTP authorization before accepting any e-mail,

1. To enable the SMTP authorization fields, click the **Edit** button at the right of the Mail IP Address field. The Edit button changes to **Save**.
2. Select the **SMTP Authorization Required** check box, located below the Domain Name field. This enables the User Name and Password fields below the check box.
3. In the User Name and Password fields, enter a user name and a password that senders must enter in order for the MGP to accept their e-mail messages.

For the User name, you can use any combination of letters, numerals, spaces, and symbols **except** the comma (,) and the single and double quotation marks (' and "). For the password, you can use all characters except the comma. The user name and password can each be from 1 to 30 characters.

NOTE You must specify **both** a user name and a password.

4. Click the **Save** button next to the Mail IP Address field to save your user name and password.

To remove SMTP authorization, click **Edit**, clear the **SMTP Authorization Required** check box, then click **Save**.

Firmware Upgrade screen

The Firmware Upgrade screen enables you to install a new version of firmware to your MGP 464. You can download the latest firmware version from the Extron Web site to your computer. Appendix B provides more details on firmware updating.

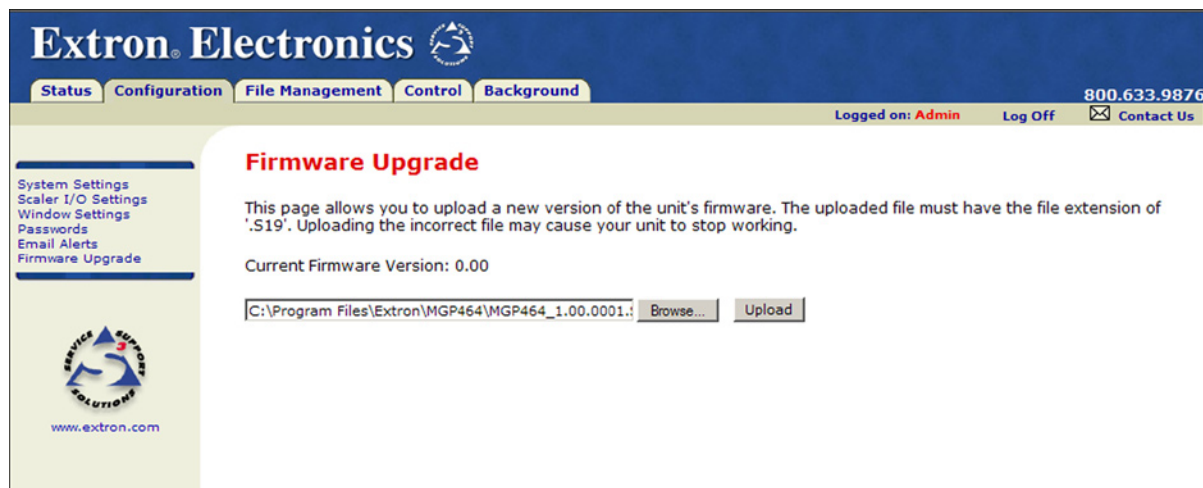

Firmware Upgrade screen

Determining the current firmware version

There are two methods you can use to find out what firmware version is currently installed on your MGP 464:

- **Using the LCD screen:** Watch the LCD window as you connect the MGP 464 to a power source. The first piece of information displayed on the screen is the firmware version (along with the product name).
- **Using the System Status Web page:** Select the Status tab on the MGP Web page to display the System Status screen. The firmware version is on the third line (to the right of the part number) in the System Description section.

Downloading the firmware

To obtain the latest version of MGP 464 firmware,

1. Visit the Extron Web site (www.extron.com) and click the **Download** tab.
2. On the Download Center page, click the **Firmware** link on the left sidebar.
3. On the Firmware page, scroll down to the "MGP 464" line, or click the letter **M** in the alphabet displayed across the top of the page.
4. Click the **Download** link located at the far right of the MGP 464 line.
5. On the next page, fill in the required information, then click the **Download_MGP464_FWxxx.exe** button. A File Download - Security Warning window is displayed.
6. Click **Save**. A Save As window opens.
7. Browse to the folder where you want to save the firmware installation file on your computer, and click **Save**.
8. When ready to install the new firmware on your computer, locate the downloaded file, and double-click on it to open it.
9. Follow the instructions on the Installation Wizard screens to install the new firmware on your computer. A Release Notes file, giving information on what has changed in the new firmware version, and a set of instructions for updating the firmware are also loaded to your computer.

Updating the firmware on the MGP 464

After you have installed the new firmware on your computer, you must upload it to the MGP 464. Follow these steps to update the firmware using the Web pages.

1. On the MGP 464's **Configuration** tab, select **Firmware Upgrade** from the sidebar menu to display the Firmware Upgrade screen.
2. Click **Browse** to open the Choose file window, and locate the firmware file on your computer or server. The file extension must be **.S19**.

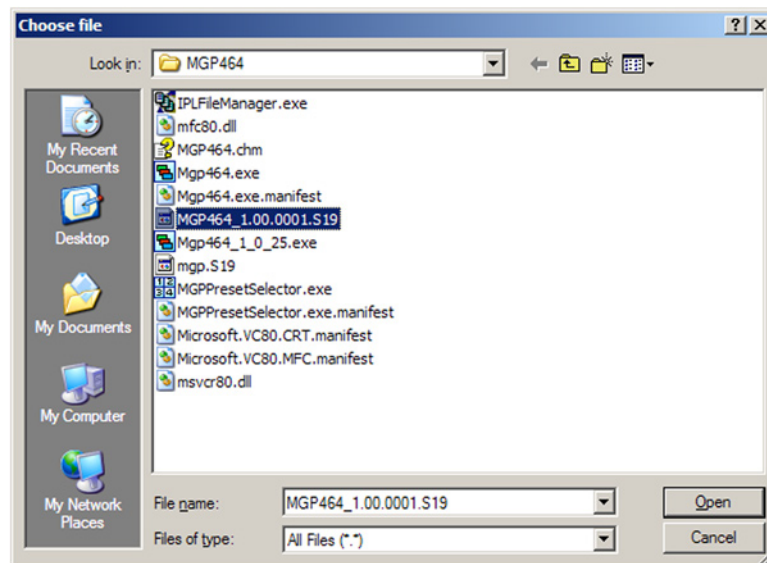

Choose file window

CAUTION

Uploading a file with an extension other than **.S19** may cause the unit to stop functioning.

HTML Configuration and Control, cont'd

3. Open the firmware file. Its name appears in the field below the Current Firmware Version on the Firmware Upgrade screen.
4. Click the **Upload** button on the Firmware Update screen to start the firmware update process. While the firmware is being uploaded, the **Upload** button changes to **Uploading...**; and the LCD window on the MGP displays first "Firmware Upload Please Wait!!!" then "Firmware Reboot Please Wait!!!"

NOTE While the firmware is uploading and rebooting, do not press any front panel buttons or make any selections on the Web pages.

When the uploading process is complete, the **Uploading...** button on the screen changes back to **Upload**.

NOTE As an alternative method of updating the MGP's firmware, you can use the Firmware Loader software. See appendix B, "Firmware Upgrade Guide," for information on downloading and using this software.

Using the File Management Page

The File Management page lets you upload files to the MGP 464 from your computer or network, and to delete files from the unit. You can also upload personalized Web pages via this screen. To access the File Management page, select the File Management tab on the MGP 464 Web page.

You can use this function to load background images from your computer or the internet to display on the output screen. All background image files must be 24-bit bitmaps. The image files must be loaded to a folder named "nortxe-graphics."

Extron Electronics

Status Configuration **File Management** Control Background

Logged on: Admin Log Off Contact Us

File Management

File Management allows you to upload and delete files from the server. File names must contain valid alpha-numeric characters. Special characters are not allowed in the file name. To add a Directory, enter the directory name in the field provided and click 'Add Dir'. Then 'Browse' and upload a file to the new directory. To delete a file or directory, click on the 'Delete' button next to the file or directory name. The 'Delete All' button deletes all contents of the current directory. If the current directory is 'ROOT', all files on the system will be deleted.

Dir: /nortxe-graphics Add Dir Browse... Upload File

Filter by File Extension: All Files: 2 Bytes Left: 17,205,760

Files	Date	File size	Delete All
(root)			
(back)			
BMP			
border1.bmp	Thu 09 Feb 2006 18:59:55 GMT	14,534	Delete
border5.bmp	Thu 09 Feb 2006 18:57:22 GMT	14,534	Delete

File Management screen

Uploading files

Names of files to be uploaded to the MGP 464 must contain only valid alphanumeric characters and underscores. No spaces or special characters (symbols) are allowed.

To upload files from the server,

1. Click the **Browse** button to the right of the file name field.
2. Browse to locate the file that you want to upload, and open it. The file's name and directory path are displayed in the file name field on the File Management screen.
3. Click the **Upload File** button. The selected file name appears in the Files column on the File Management screen. (Files are listed separately under headings of their extensions.)

Adding a directory

To add a directory or folder to the MGP 464's file system,

1. Enter the directory name in the Dir: field, following the slash (/).
2. Click the **Add Dir** button.
3. With the directory name displayed, perform the Uploading files procedure described in the previous section to add a file to the directory. The directory name appears at the top of the Files column, preceded by a slash.

To add more files to the directory, click the directory name to open it, then use the Uploading files procedure. To exit the directory, click **(root)** or **(back)**.

Other file management activities

You can also perform the following tasks on the File Management screen:

Open a file — Click on the name of the file in the Files column.

Delete a file — Click the **Delete** button at the right end of the line that contains the file you want to remove.

Delete all files — Click the **Delete All** button.

Display files by file extension — The Filter by File Extension menu lists the extensions of the files that have been uploaded to the MGP. This menu lets you choose to display only files with the extension you select. Select **All** to display all uploaded files.

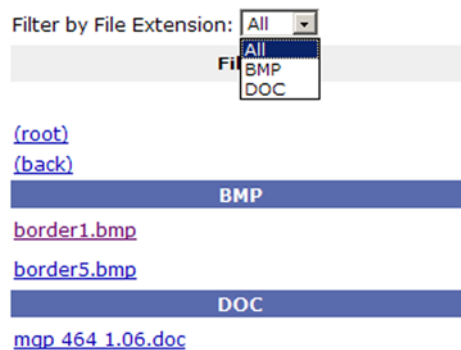

Filter by File Extension menu

HTML Configuration and Control, cont'd

Using the Control Page

The screens that you can access through the Control page enable you to configure the windows and images, select inputs, and manage window and input presets.

Picture Controls screen

The Picture Controls screen allows you to configure and control the MGP 464 windows and the images within them. You can also select the input for each window.

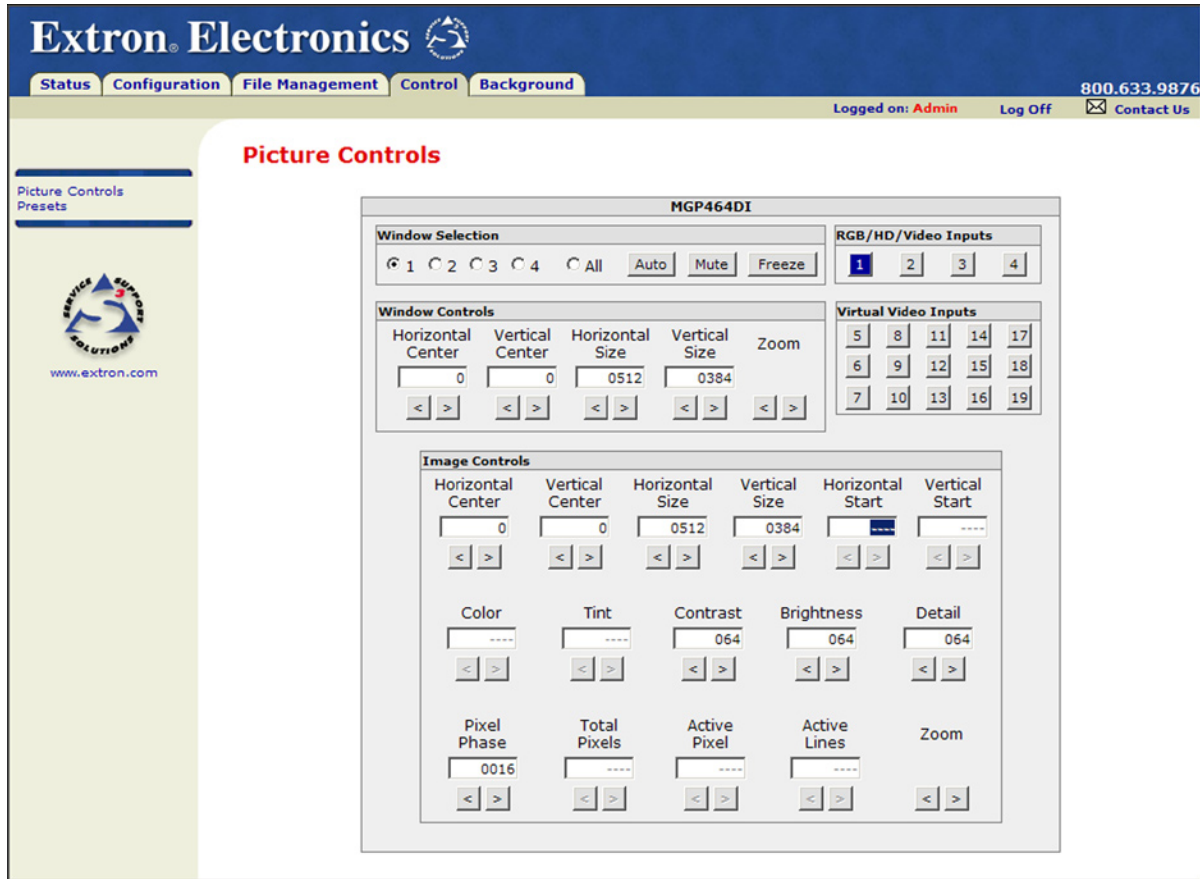

Picture Controls screen

The Picture Controls screen contains the following sections:

Window Selection

This section contains the following buttons:

Window radio buttons — Select one of the radio buttons to specify the window(s) to which the other selections on this screen will apply.

NOTE The **All** radio button cannot be used to make adjustments in the Window Controls and the Image Controls section. These selections must be made for one window at a time.

Auto — Click this button to perform an automatic image adjustment to the selected window. The MGP measures where the active area starts and stops, and adjusts input sampling accordingly, so that the image fills the window.

When you click **Auto**, the processor measures the sync frequencies of the incoming video source and sets the active image area and sampling frequency. If an unknown input is connected to the MGP, the processor measures and estimates the resolution of the incoming video. If the estimate proves not to be accurate, the Auto Image function makes measurements to more accurately set up the input sampling.

Mute — The **Mute** button closes or opens the selected window. When the selected window is muted, this button is highlighted. To unmute the selected window, click **Mute** again. The highlighting is removed from the button.

Freeze — The **Freeze** button freezes the current image in the currently selected window. When the image in the selected window is frozen, this button is highlighted. To unfreeze the selected window, click **Freeze** again. The highlighting is removed from the button.

If you switch inputs while a window is frozen, the freeze mode is cancelled and the new input's image appears in the window.

NOTE *In order to see your **Mute** and **Freeze** selections reflected on the front panel, you must also press the front panel Output Window button that corresponds to the window you selected on the screen. (The **Mute** and **Freeze** buttons blink while muting and freezing, respectively, are enabled.)*

Input sections

In the following sections, you can click a button to specify an input for the currently selected window. When an input is selected, its button is highlighted on the screen.

RGB/HD/Video Inputs — Click one of these buttons to choose one of the fully configurable inputs (1 through 4) for the selected window. On the MGP 464 DI, these buttons also select among the four DVI inputs.

Virtual Video Inputs — Click one of these buttons to choose one of the virtual inputs (5 through 19) for the selected window. These inputs can pass only YUVi component video, S-video, or composite video signals, and cannot be configured from the front panel.

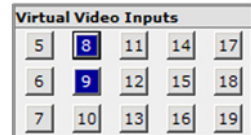

The virtual inputs are configurable in sets of three, arranged in columns on the screen. When you click a button for an input that is configured as YUVi, all three buttons in the group change to blue. When you click a button for an S-video input, the top two buttons become blue (shown in the example at right). When you click a composite video input button, only the button you clicked turns blue.

NOTE *In order to see your input selection reflected on the front panel, you must also press the front panel Output Window button that corresponds to the window you selected on the screen. (The button for the selected input lights.)*

HTML Configuration and Control, cont'd

Window Controls

The Window Controls section contains five sets of controls that enable you to make some adjustments to the selected window on the display. In the Horizontal and Vertical Center and Size fields, you can make adjustments by entering a number in the text box or by clicking the arrow buttons. The Zoom control can be adjusted only by arrow buttons.

NOTE *While adjusting the window controls, watch the image on your display screen to observe the effects of your adjustments.*

In the Window Controls section, you can make the following adjustments:

Horizontal Center — Move the selected window to the right or left on the display.

The value in the text box is the distance in pixels of the window's left edge from the left edge of the display. The range is determined by the output size; the default is 0 plus or minus the output rate.

Vertical Center — Move the selected window up or down on the display. The value in the text box is the distance in lines of the window's top edge from the top edge of the display. The range is determined by the output rate; the default is 0 plus or minus the output rate.

Horizontal Size — Stretch or shrink the selected window horizontally. The value in the text box is the window's width in pixels. The range is determined by the output rate.

Vertical Size — Stretch or shrink the selected window vertically. The value in the text box is the window's height in lines. The range is determined by the output rate.

Zoom — Change the view of the image between near and far on the display (magnifying or reducing the total view).

Image Controls

The Image Controls section contains 16 fields that enable you to make adjustments to the image in the selected window on the display. In most of these fields, you can make adjustments by entering a number in the text box or by clicking the arrow buttons. The Zoom control can be adjusted only by arrow buttons.

NOTE *While adjusting the image controls, watch the image on your display screen to observe the effects of your adjustments.*

In this section, you can make the following adjustments:

Horizontal Center — Move the image to the right or left in the selected window.

The value in the text box is the distance in pixels of the image's left edge from the left edge of the window. The range is dependent on the output rate; the default is 0 plus or minus the output rate.

Vertical Center — Move the image up or down in the selected window. The value in the text box is the distance in lines of the image's top edge from the top edge of the window. The range is dependent on the output; the default is 0 plus or minus the output rate.

Horizontal Size — Stretch or shrink the image horizontally. The value in the text box is the width of the image in pixels. The range is dependent on the output rate.

Vertical Size — Stretch or shrink the image vertically. The value in the text box is the height of the image in lines. The range is dependent on the output rate.

Horizontal Start Location — Specify the distance in pixels from the left edge of the selected input's total video display area to the left edge of its active area. The default is 128.

Vertical Start Location — Specify the distance in lines from the top edge of the selected input's total video display area to the top edge of its active area. The default is 128.

Color — Adjust the intensity of the colors in the selected window. (At the lowest adjustment, all colors appear as shades of gray.) The range is 000 to 127; the default is 064.

Tint — Change the appearance of the colors in the selected window. The range is 000 to 127; the default is 064.

Contrast — Increase or decrease the range of image light and dark values in the selected window. The range is 000 to 127; the default is 064.

Brightness — Increase or decrease the intensity of video light in the selected window. The range is 000 to 127; the default is 064.

Detail — Adjust the sharpness of the image in the selected window. The range is 000 to 127; default is 064.

Pixel Phase — Adjust the point at which pixels are sampled for the image in the selected window. The range is 1 to 31; the default is 16.

Total Pixels — Increase or decrease the width in pixels of the total line of video. The default is the auto-sensed value. The range is ± 512 from the auto-sensed value.

Active Pixels — Increase or decrease the width in pixels of the active video area of the selected input. The default is the auto-sensed value. The range is ± 512 from the auto-sensed value.

Active Lines — Increase or decrease the height in lines of the active video area of the selected input. The default is the auto-sensed value. The range is ± 512 from the auto-sensed value.

Zoom — Increase or decrease the size of the image in the selected window while keeping the aspect ratio constant. The range is dependent on the output rate.

HTML Configuration and Control, cont'd

Presets screen

On the Presets screen, you can name, save and recall window presets; and save and recall input presets.

The screenshot shows the Extron Electronics web interface for the MGP464DI device. The top navigation bar includes 'Status', 'Configuration', 'File Management', 'Control', and 'Background'. The user is logged in as 'Admin'. The main content area is titled 'Presets' and contains the following sections:

- Window Presets:** A text input field containing 'WindowPreset-001' and a 'Change Preset Name' button.
- Preset Save / Recall:** A 'Select Preset:' dropdown menu showing 'WindowPreset-001', and buttons for 'Save Preset', 'Recall Preset', 'Recall Preset with Input', and 'Cancel'.
- Window Preset Effect:** Two dropdown menus: 'Window Effect' set to 'Real time motion' and 'Effect Duration' set to '5 sec'.
- Input Presets:** 'Window Selection' radio buttons for 1, 2, 3, and 4 (radio 2 is selected), an 'Input Preset:' dropdown menu set to '8', and 'Save Preset' and 'Recall Preset' buttons.

Presets screen

Window Presets

A window preset is a file containing all the settings that have been specified for the windows. The MGP 464 has 128 preset memory locations, in which it can store up to 128 window presets. Presets save information for all four windows.

The following settings can be saved in a window preset:

- Window border color
- Window priority
- Window mute status
- Label text color
- Label text size
- Label location
- Label border color
- Label background color
- Window background setting
- Window size/position
- Image size/position in the window

Default presets

The MGP 464 is delivered with 30 different default window presets, which are stored in the MGP's 128 preset memory locations. (Because there are more memory locations than presets, each default preset is stored in at least two locations.) The following figure shows the factory default preset window configurations. These presets can be used for any output rate. If you overwrite them, you can recover them by selecting Factory Defaults from the Advanced Configuration menu.

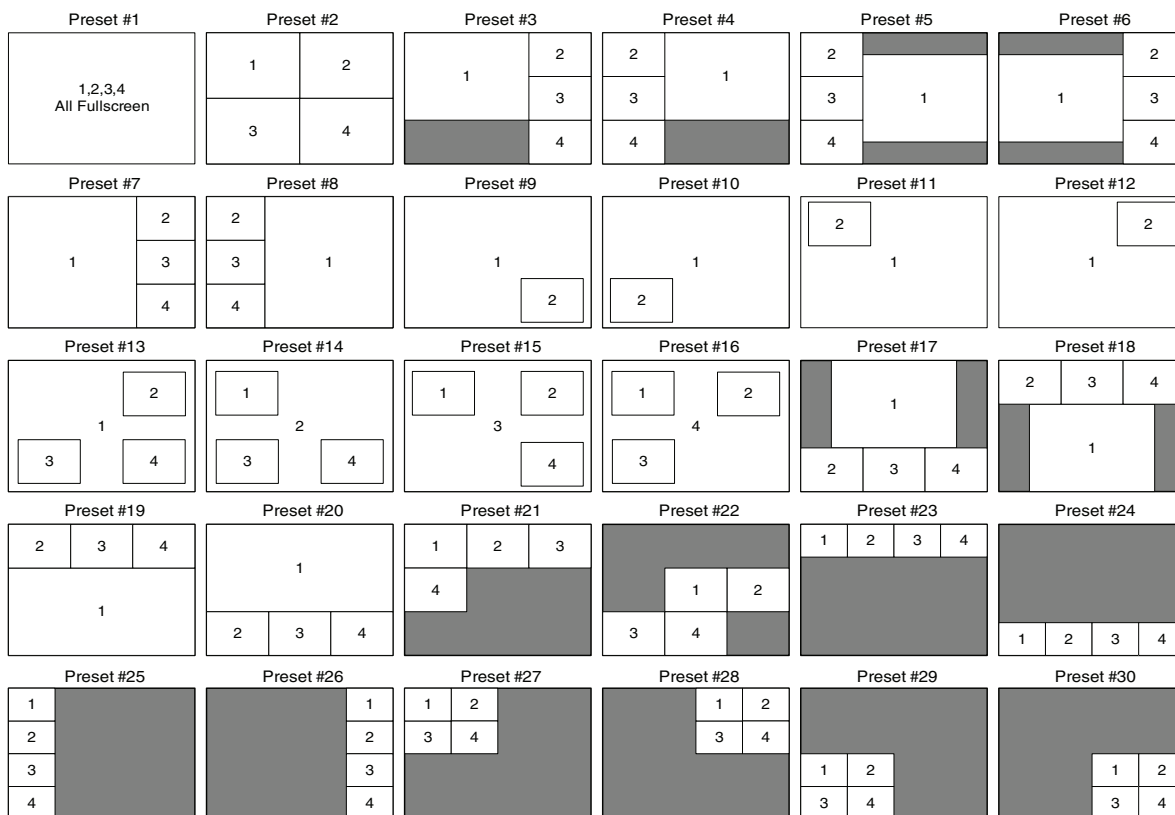

Factory default preset configurations

In the Window Presets section, you can do the following:

Naming a window preset

To change the name of a preset,

1. From the Select Preset menu in the Preset Save/Recall section, select a preset to rename. The name of your selected preset is displayed in the Preset Name field.
2. In the Preset Name field, enter the name you want to give the selected preset. The following characters are may be used:

Symbols: : / - + " _ [space]

Numerals: 0 through 9

Letters: Lowercase a through z, uppercase A through Z

3. Click the **Change Preset Name** button. The new name replaces the one you selected on the Select Preset menu.

HTML Configuration and Control, cont'd

Saving (creating) a window preset

To save all the current window settings as a preset,

1. From the Select Preset menu, select the preset number to which you want to save the current settings for all the windows.
2. Click Save Preset.

Recalling a window preset

To recall a saved preset and enable all its settings,

1. From the Select Preset menu, select the name of the preset that you want to recall.
2. If you want to recall all window settings contained in the selected preset, including the input displayed when the preset was saved, click **Recall Preset with Input**.

If you do not want to recall the inputs for the selected preset, click **Recall Preset**.

Selecting a window preset transition effect

In the Window Preset Effect section, you can select either a cut or a slide transition effect with which windows will be resized and/or repositioned when a new preset is selected.

- **Cut effect** — The window immediately moves to the location specified for it in the new preset, and is instantly resized.
- **Real time motion effect** — The window appears to slide to its new position and is resized slowly enough for its progress to be observed.

Follow these steps to specify a window transition effect between presets:

1. From the Window Effect menu, select **Real time motion** or **Cut**.
2. From the Effect Duration menu, select the amount of seconds the MGP will take to complete the transition to its new size and location.

NOTE *Effect Duration applies only if the **Real time motion** effect was selected.*

NOTE *The duration set here is the same value as the Window Effect duration.*

Input Presets

An input preset is a file containing settings such as the signal type, image control settings, and window text for the input that is currently displayed in a selected window. The MGP 464 has 128 memory preset locations to which you can save settings as input presets.

The following settings are contained in the input presets:

Input Type	Horizontal Start	Total Pixels
Input Name	Vertical Start	Active Pixels
Film Mode On/Off	Pixel Phase	Active Lines
Brightness	Contrast	Color
Tint	Detail (sharpness)	Percentage of window filled*

*Image size and position are saved as a percent of the window, so that the input preset can be used for any size window.

In the Input Presets section, you can do the following:

Saving (creating) an input preset

To save all the settings for the currently selected input as a preset,

1. Select a Window Selection radio button to specify the window whose group of settings for the current input will be saved as a preset.
2. From the Input Preset menu, select a preset number to which you want to save the input's settings.
3. Click **Save Preset**.

Recalling an input preset

To recall a saved preset and enable all its settings on your MGP 464,

1. Select a Window Selection radio button to specify the input for which the settings will be recalled.
2. From the Input Preset menu, select the preset number you want to recall.
3. Click the **Recall Preset** button to enable all settings contained in the selected preset.

Using the Background Page

The Image Settings screen on the Background page lets you select a background for the output display. You can choose a background color, or you can upload bitmap images to the MGP, and select one as the display background. You can also specify the image from a DVI input to display live as the background on the screen.

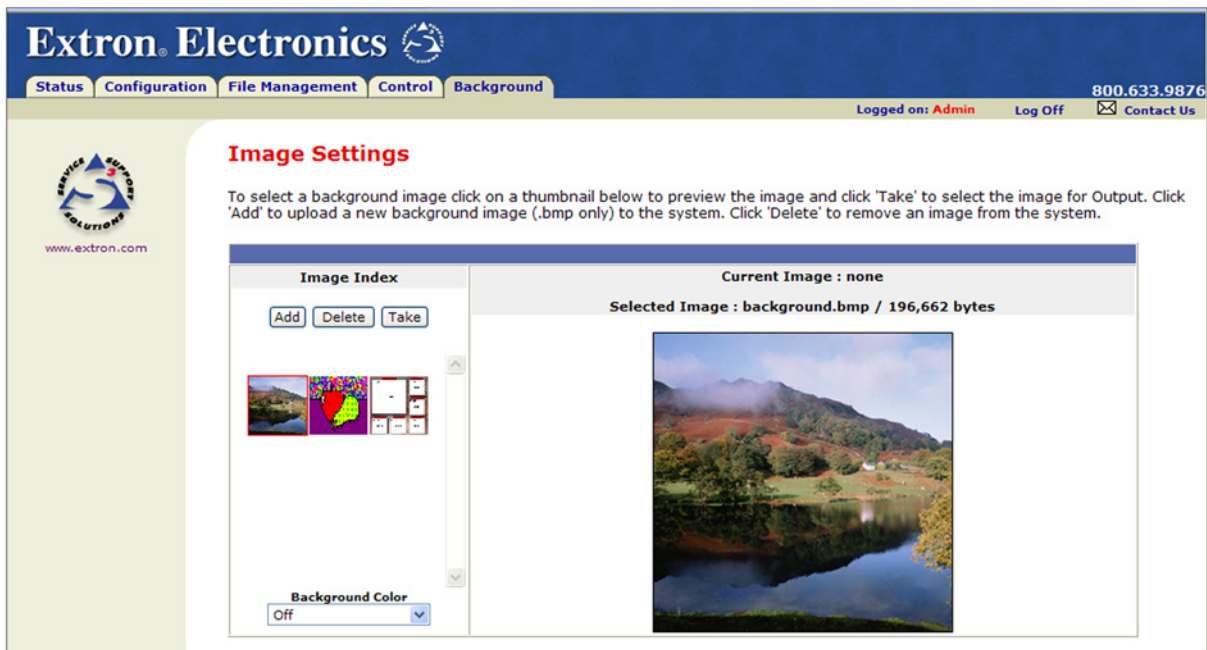

Selecting a background color

To change the background color on the output display, select a color from the Background Color pull-down menu. The default selection, **Off**, results in a black background.

HTML Configuration and Control, cont'd

Displaying a background image

An image can be displayed as a background behind the windows on the output screen. This can be done by uploading a bitmap image to the MGP and selecting it by using the **Add** and **Take** buttons.

Using a DVI input

To use the unscaled image from a DVI source as a live background on the output screen,

1. Connect a DVI source to the DVI Background connector on the rear panel.
2. From the Background Color menu, select **DVI Background Input**.

Using a bitmap image

The Image Settings screen lets you upload bitmap images, including those saved via background capture, from your computer to the MGP; and to select an uploaded image as the background for the output screen.

NOTE *The MGP 464 supports only 24-bit bitmap files as backgrounds. The background file names must have a .bmp extension. The MGP 464 has 16 MB of memory to store captured or loaded images. See "Background Capture menu" in chapter 3, "Operation," to calculate the size of an image.*

Uploading an image

To upload a bitmap image to the MGP,

1. In the Image Index field, click **Add**. The Add Image field is displayed.

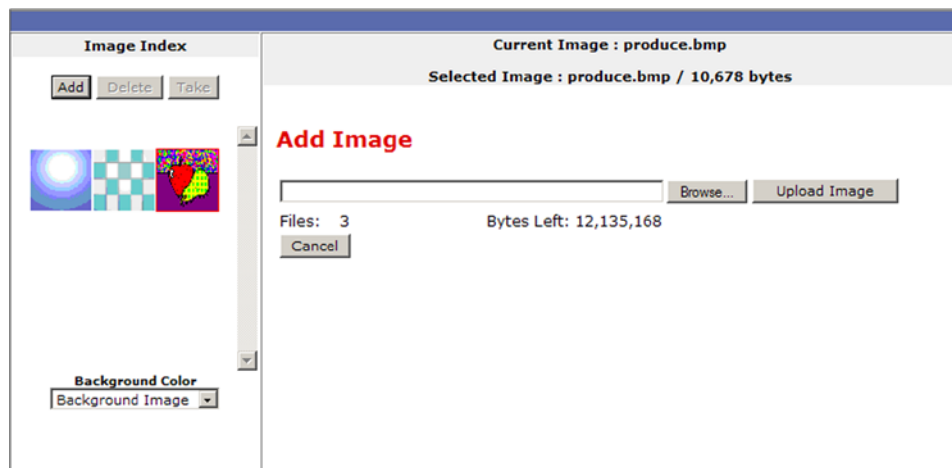

Add Image field on the Image Settings screen

2. Click **Browse** to open the Choose file window, and locate the image (.bmp) file that you want to upload.
3. Open the image file in the Choose File window. Its name and the path to it are displayed in the Add Image field on the Image Settings screen.
4. Click **Upload Image**. This button changes to **Uploading...** while the file is being loaded.

When the uploading is complete, a thumbnail image of the uploaded file is displayed in the Image Index section.

Selecting a background image

To select an uploaded image to be displayed as the background on the output screen,

1. In the Image Index section, click on the thumbnail of the image you want to display. A larger version of the selected image appears to the right.
2. Click **Take** to select that image for the output background.

HTML Configuration and Control, cont'd



MGP 464 Multi-Graphic Processor

6 Chapter Six

Special Applications

Application 1: Connecting the MGP 464 to a Matrix Switcher

Application 2: Connecting Multiple MGP 464s in Succession (Daisy-chaining)

Special Applications

This chapter describes some special types of applications that represent unique conditions. For the MGP 464 to operate properly in these situations, it is important that it be configured correctly. On the following pages, two application examples are described, along with their requirements for the MGP 464.

Application 1: Connecting the MGP 464 to a Matrix Switcher

When the MGP 464 is attached to a matrix switcher, such as the CrossPoint Ultra shown below, inputs 1 through 4 come to the MGP through the switcher, which supports RGB, component video, S-video, and composite video signal types.

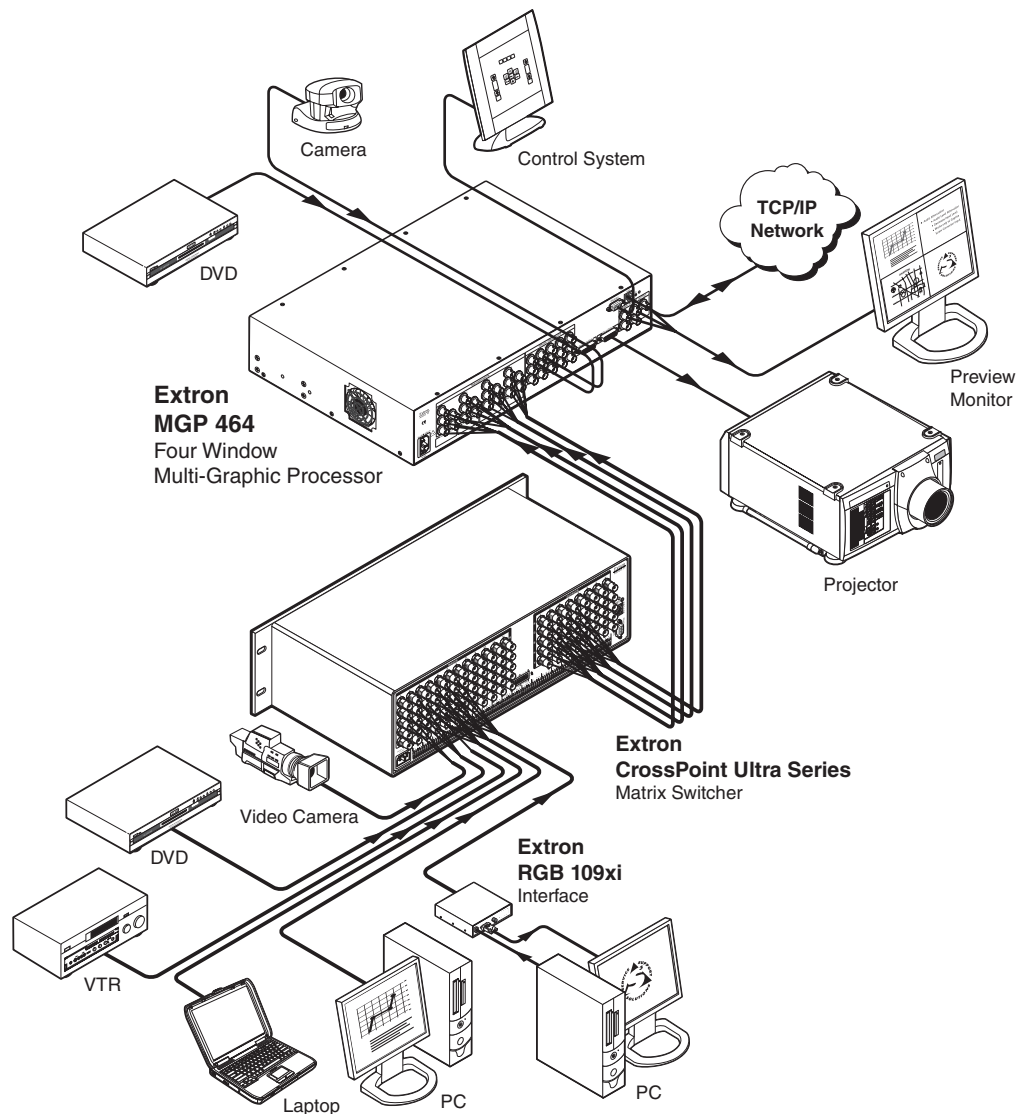

MGP 464 connected to a matrix switcher

In this type of configuration, the following occurs:

- On the MGP, window 1 displays input 1, window 2 displays input 2, and so forth.
- Input switches are made at the matrix switcher instead of at the MGP.
- Input presets are recalled on the MGP to correctly set up the input coming from the switcher. This setup can include the video signal type; picture controls; advanced input configuration functions such as setting the active lines/pixels, total lines/pixels, and pixel phase; and the input name.

You can perform the required MGP setup operations using any of the following:

- SIS commands (See chapter 4.)
- The MGP 464 Web pages (See chapter 5.)
- The Windows-based control software (See chapter 4 and the software's Help.)

Setting up the MGP to work with the switcher

Follow these steps to set up the MGP to work with a matrix switcher.

1. Install and connect the MGP as described in the "Installation Overview" section of chapter 2, "Installation," **with the exception of step 3**. In place of step 3, do the following:

Connect the MGP's four fully-configurable inputs to four of the matrix switcher's outputs. (See the diagram below.)

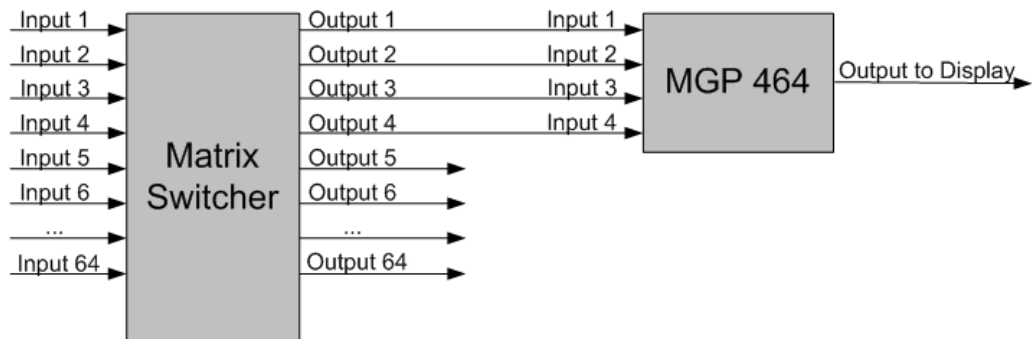

Connecting the matrix switcher to the MGP 464

2. Size the windows on the MGP to full screen. You can do this quickly by selecting window preset 1, 31, 61, 91, or 121.
3. On the matrix switcher, tie input 1 to the four switcher outputs that are connected to the MGP 464. (Refer to your matrix switcher user's manual for the procedure.)
4. Select window 1 on the MGP, and configure the input as follows:
 - a. Set the following input sampling parameters as desired: signal type, horizontal and vertical start, total pixels, active pixels, and active lines.
 - b. Set the following picture controls as desired: image size, image position, color, tint, brightness, and contrast.
 - c. Set the pixel phase for window 1, then mute the window to display the next window behind it. Repeat this step for windows 2, 3, and 4.
 - d. Save the adjusted settings as Input Preset 1.

Special Applications, cont'd

5. Repeat step 4 for every input on the matrix switcher that will be displayed on the output screen via the MGP, saving the settings for each input as Input Preset 2, 3, etc.

NOTE Each input preset must be saved with the same number as the input on the matrix switcher.

6. Synchronize the MGP 464 to the matrix switcher as follows:
 - a. Open the Windows-based control software.
 - b. From the Tools menu, select **Sync MGP 464 to Matrix Switcher...**. The Sync MGP 464 to Matrix Switcher window opens.
 - c. In the IP Address field, enter the matrix switcher's IP address.
 - d. Click **Connect To Matrix** button. The switcher's matrix size is displayed to the right of the button, and its input-output ties are displayed in the Matrix Status section below.
 - e. From the drop-down menu in the MGP 464 Input #1 field, select the number of matrix switcher output to which you connected the MGP's input 1 in step 1.
 - f. Repeat step e for MGP inputs 2 through 4, making sure to select the number of the switcher's output connector to which you attached the MGP input with which you are working.
 - g. Click **Take** to tie the MGP inputs to the selected switcher outputs.
 - h. Click **Close** to close the Sync MGP to Matrix Switcher window.

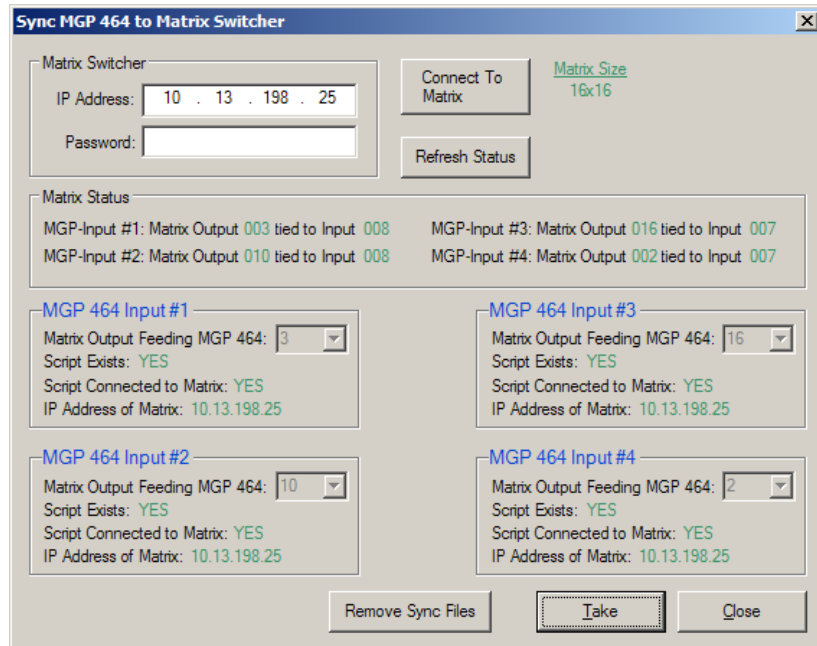

Sync MGP 464 to Matrix Switcher window with input ties to switcher

Using the MGP and the matrix switcher after the MGP is synchronized to the matrix switcher

After you have performed step 6, above, be sure to do the following when using the MGP with the switcher:

- Set up the inputs so that MGP window 1 always displays input 1, window 2 displays input 2, window 3 displays input 3, and window 4 displays input 4.
- Perform all input switching using the matrix switcher. A 1-second RGB delay is recommended to minimize the amount of video sync noise while the processor locks onto the new signal.
- Window presets can be recalled, but they must be recalled “without input,” so that the inputs remain matched to the windows with the same numbers.
- Input presets do not have to be issued manually to the MGP. The MGP senses when the matrix switcher changes input ties and recalls the matching input preset.

Minimizing synchronization problems when *not* using the Sync to Matrix feature

When operating the system using a manually configured control system (for which Sync to Matrix was not used), you can avoid synchronization problems that cause unwanted image blanking or scrambling during input switches by doing the following:

1. While setting up the switcher and the MGP to work together, set the RGB delay on the matrix switcher to greater than or equal to 1.0 second.
2. Create a tie on the matrix switcher from desired input X to the output number that corresponds to MGP window Y, in which input X will be displayed.
3. Immediately (within 1 second) recall the input preset with the same number as switcher input X that you selected in step 2 (preset X), to MGP window Y.

NOTE *Input presets cannot be recalled via the MGP front panel. You can recall them via SIS commands (see chapter 4, “Software Configuration and Control”), the MGP 464 Web pages (see chapter 5, “HTML Configuration and Control”), or the Windows-based control software/Preset Selector (see chapter 4, “Software Configuration and Control,” and the control software’s help file).*

Application 2: Connecting Multiple MGP 464s in Succession (Daisy-chaining)

By connecting multiple MGP 464s together in succession (“daisy-chaining”) via the DVI Output and DVI Background connectors, you can display up to 12 windows on the output screen. You can connect up to three MGPs in this way. (See the diagrams on the next page.)

Connecting via the DVI Background connector has the advantage of the input not being scaled. Therefore, no analog/digital sampling is required and there is no signal loss.

NOTE *In the diagrams, the MGPs are given letters in the order of their priority, starting with the unit closest to the output display. Therefore, the **first** MGP in the chain is shown as unit C (or B, if there are only two MGPs). The second MGP is designated as unit B, and the third is unit A.*

The illustration on the next page shows diagrams of three possible configurations.

- 8-window configuration:** Two MGP 464s are daisy-chained together, so that eight windows (four from each MGP) are displayed on the output screen.
 - The DVI Output of the first MGP (unit B) is connected to the DVI Background input of the second MGP (unit A).
 - The first diagram in the row shows the output display with one MGP attached. The second diagram shows the display with two MGPs attached.
- 12-window configuration:** Three MGP 464s are daisy-chained so that 12 windows are displayed on the output screen.
 - The DVI Output of the first MGP (unit C) is connected to the DVI Background input of the second MGP (unit B).
 - The DVI Output of the second MGP (unit B) is connected to the DVI Background input of the third MGP (unit A).
 - The first diagram in the row shows the output display with one MGP attached. The second diagram shows the display with two MGPs attached. The third diagram shows the display with all three units connected.
- 8-window with DVI background configuration:** A DVI computer (or another DVI source) is daisy-chained to two MGP 464s, so that eight windows are displayed in front of a live video background from the DVI source.
 - The DVI source is connected to the DVI Background input of the first MGP (unit B).
 - The DVI Output of the first MGP (unit B) is connected to the DVI Background input of the second MGP (unit A).
 - The first diagram in the row shows the DVI computer, which is the input source. The second diagram shows the display with one MGP attached. The third diagram shows the display connected to two MGPs.

1. 8 Window Configuration

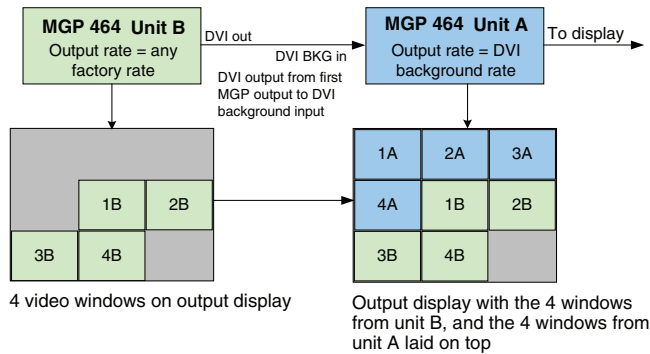

2. 12 Window Configuration

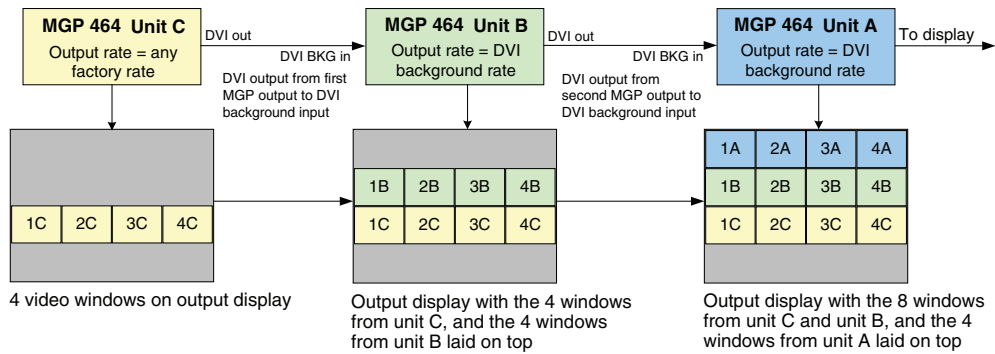

3. 8 Window Configuration with a DVI Computer Background

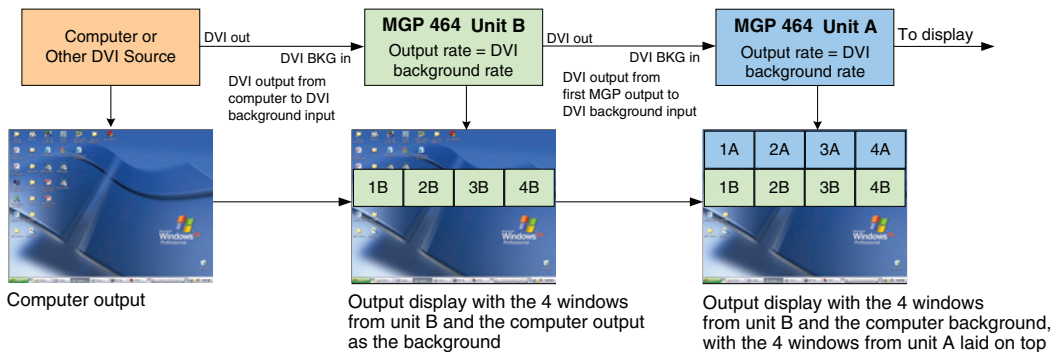

Daisy-chain configuration examples

Setting up MGPs for daisy-chaining

Follow these steps to set up one to three MGPs in a daisy-chain formation:

1. Connect input sources to the MGP to be displayed in the windows.
2. Connect the DVI output of the first MGP (the unit farthest from the display) to the DVI Background connector of the second MGP. If you are daisy-chaining three units, connect the DVI output of the second MGP to the DVI Background connector of the third unit (the unit connected to the display).

Special Applications, cont'd

3. Configure the output as follows:
 - a. Set the output resolution/refresh rate of the first MGP (the unit farthest from the display) to your output display's native rate.
NOTE *Do not set this unit to the DVI background rate.*
 - b. Set the output rates of the second and, if appropriate, the third MGP to "DVI Background Rate." This setting uses the incoming DVI resolution and pixel clock as the output rate of the MGPs, which is essential in order to avoid any sampling of the incoming DVI signal.
NOTE *By default, the resolution provided in the Extended Display Identification Data (EDID) is the last selected factory rate. To manually set the resolution information provided in the EDID data, see the Set EDID information SIS command on page 4-9.*
 - c. If it has not yet been selected, set the background of the second and third MGPs to "DVI Background." When you do this, these two units set their output rates to the DVI background rate.
NOTE *The DVI background rate remains in effect, even when the background is not set for DVI Background. This prevents any image scrambling on the display when the system is switching between the DVI background source and other background images or colors.*
4. Configure the windows on all the MGPs as follows:
 - a. Mute the windows on the second and third MGPs to view the windows on the first MGP only.
 - b. Set the size and position of the four windows on the first MGP, either manually or by selecting a window preset.
 - c. Save the configuration for the first MGP as a window preset, for future use.
 - d. Unmute the windows for the second MGP in the chain and configure them as desired. Save this window configuration as a preset.
NOTE *The default presets provided with the MGP have no background selected. For the second and third MGPs in the chain, you must select "DVI background" as the background.*
 - e. Repeat step **d** for the third MGP if appropriate.
NOTE *It is recommended that you save the window configurations on the second and third MGPs with the same preset number. This is required if you are using the Preset Selector software for both MGPs, because the Preset Selector recalls the same preset number for all MGPs that have been added to it.*

Refer to the Windows-based control software help file for information on using the Preset Selector.



MGP 464 Mult-Graphic Processor

A

Appendix A

Specifications, Part Numbers, and Accessories

Specifications

Part Numbers and Accessories

Specifications, Part Numbers, and Accessories

Specifications

Number/signal type.....	4 VGA-UXGA DVI, RGBHV, RGBS, RGsB, RsGsBs, RGBcvS, component video (interlaced or progressive), S-video, composite video 4 to 15 (configurable) component video (interlaced), S-video, or composite video 4 single link DVI digital video (MGP 464 DI only) 2 HD-SDI digital video, 2 single link DVI digital video (MGP 464 HD-SDI only)
Inputs 1-4.....	(4) x 5 female BNC (all models) 4 female DVI-I (DI models only) 2 female BNC, 2 female DVI-I (HD-SDI models only)
Inputs 5-19.....	15 female BNC
Nominal level	1 Vp-p for Y of component video and S-video, and for composite video 0.7 Vp-p for RGB and for R-Y and B-Y of component video 0.3 Vp-p for C of S-video
Minimum/maximum levels.....	Analog: 0.0 V to 2.0 Vp-p with no offset
Impedance	75 ohms
Horizontal frequency.....	15 kHz to 100 kHz
Vertical frequency.....	50 Hz to 120 Hz
Resolution range	640x480 to 1920x1200*, 480p, 576p, 720p, 1080i, and 1080p *Only the reduced blanking version of the 1920x1200 resolution is sampled at full bit rate. HD-SDI models accept the resolutions listed above on the non-HD-SDI inputs. The HD-SDI inputs themselves accept only the following resolutions: 720p ^{2,4,5,6,7} , 1080i ^{6,7} , 1080psf ¹ , 1080p ^{1,2,3,4} ¹ = at 24 Hz, ² = at 25 Hz, ³ = at 29.97 Hz, ⁴ = at 30 Hz, ⁵ = at 50 Hz, ⁶ = at 59.94 Hz, ⁷ = at 60 Hz
DC offset (max. allowable).....	0.5 V

Video processing

Digital sampling.....	24 bit, 8 bits per color; 13.5 MHz standard (video), 162 MHz standard (RGB)
Colors.....	16.78 million

Video output

Number/signal type.....	1 scaled RGBHV, RGBS, RGsB, HD YUV component video
Connectors	5 BNC female, 1 DVI-I female
Nominal level	1 Vp-p for Y of component video and S-video, and for composite video 0.7 Vp-p for RGB and for R-Y and B-Y of component video
Minimum/maximum levels.....	0.0 V to 1.0 Vp-p
Impedance	75 ohms
Vertical frequencies.....	50 Hz, 60 Hz, 72 Hz, 96 Hz, 100 Hz, 120 Hz
Scaled resolution	640x480 ^{1,2,3,4,5,6} , 800x600 ^{1,2,3,4,5,6} , 852x480 ^{1,2,3,4,5} , 1024x768 ^{1,2,3,4} , 1024x852 ^{1,2,3,4} , 1024x1024 ^{1,2,3} , 1280x768 ^{1,2} , 1280x1024 ^{1,2} , 1360x765 ^{1,2} , 1365x768 ^{1,2} , 1365x1024 ^{1,2} , 1366x768 ^{1,2} , 1400 x 1050 ^{1,2} , 1600 x 1200 ^{1,2} HDTV: 480p ² , 576p ¹ , 720p ^{1,2} , 1080i ^{1,2} , and 1080p ^{1,2} ¹ = at 50 Hz, ² = at 60 Hz, ³ = at 72 Hz, ⁴ = at 96 Hz, ⁵ = 100 Hz, ⁶ = 120 Hz
Return loss	-30 dB @ 5 MHz
DC offset	±25 mV with input at 0 offset
Switching type	Triple-Action

Sync

Input type	RGBHV, RGBS, RGsB, RsGsBs, RGBcvS, YUV (tri-level or bi-level on Y channel)
Output type.....	RGBHV, RGBS, RGsB, YUV (tri-level or bi-level on Y channel)

Standards.....	NTSC 3.58, NTSC 4.43, PAL, SECAM, SMPTE 292M
Input level	0.0 V to 5.0 Vp-p
Output level.....	0.6 Vp-p for component video (tri-level sync) TTL: 5.0 Vp-p, unterminated for RGBHV, RGBS
Input impedance	510 ohms
Output impedance	75 ohms
Polarity.....	Positive or negative (selectable)

Control/remote — processor/decoder/scaler

Serial control port	(1) RS-232 or RS-422, 9-pin female D connector (1) RS-232, 2.5 mm stereo mini jack
Baud rate and protocol.....	300 to 115200 baud (default: 9600), 8 data bits, 1 stop bit, no parity
Serial control pin configurations	
9-pin D connector.....	RS-232: 2 = TX, 3 = RX, 5 = GND RS-422: 2 = TX-, 3 = RX-, 5 = GND, 7 = RX+, 8 = TX+
2.5 mm mini stereo jack....	Tip = TX, ring = RX, sleeve = GND
Ethernet control port.....	1 RJ-45 female connector
Ethernet data rate.....	10/100Base-T, half/full duplex with autodetect
Ethernet protocol.....	ARP, DHCP, ICMP (ping), TCP/IP, Telnet, HTTP, SMTP
Program control.....	Extron's control/configuration program for Windows® Extron's Simple Instruction Set (SIS™) Microsoft® Internet Explorer, Telnet

General

Power	100 VAC to 240 VAC, 50-60 Hz, 30 watts, internal
Temperature/humidity.....	Storage: -40 to +158 °F (-40 to +70 °C) / 10% to 90%, noncondensing Operating: +32 to +122 °F (0 to +50 °C) / 10% to 90%, noncondensing
Cooling	Fan, right to left (as viewed from the front panel)
Rack mount	Yes, with included brackets
Enclosure type	Metal
Enclosure dimensions	3.4" H x 17.5" W x 12.0" D (2U high, 1 rack wide) (8.6 cm H x 44.5 cm W x 30.5 cm D) (Depth excludes connectors and knobs. Width excludes rack ears.)
Product weight	8.5 lbs (3.9 kg)
Shipping weight	18 lbs (9 kg)
Vibration	ISTA 1A in carton (International Safe Transit Association)
Regulatory compliance	
Safety.....	CE, CUL, UL
EMI/EMC	CE, C-tick, FCC Class A, ICES, VCCI
Environmental	Complies with the appropriate requirements of WEEE.
MTBF.....	30,000 hours
Warranty	3 years parts and labor

NOTE All nominal levels are at ±10%.

NOTE Specifications are subject to change without notice.

Specifications, Part Numbers, and Accessories, cont'd

Part Numbers and Accessories

Included parts

These items are included in each order for an MGP 464:

Included parts	Replacement part number
MGP 464	60-771-01
MGP 464 DI	60-771-02
MGP 464 HD-SDI	60-771-03
Rack mounting brackets kit	70-155-01
IEC power cord	
Rubber feet, self-adhesive	
<i>MGP 464 User's Manual</i>	
Windows-based control software on CD-ROM	

Optional accessories

These items can be ordered separately:

Accessory	Part number
DVI-D male-to-male 6' patch cable	26-584-06
9-pin D female to 2.5 mm TRS configuration cable	70-335-01



MGP 464 Multi-Graphic Processor

Appendix B

Firmware Update Guide

Determining the Firmware Version

Downloading the Firmware

Updating the Firmware

Firmware Upgrade Guide

Updates to the Extron MGP 464 Multi-Graphic Processor firmware are made available periodically via the Extron Web site. If the need arises, you can replace the MGP 464's main firmware via an IP connection without opening the unit.

Determining the Firmware Version

There are three ways to check which version of firmware the MGP 464 is using: view the front panel LCD window during power-on, view the System Status page of the MGP 464's embedded Web pages, or select **About MGP...** from the Windows-based control software Help menu.

Using the LCD display at power-on

Watch the LCD window as you connect the MGP 464 to a power source. The first piece of information displayed on the screen is the firmware version (along with the product name).

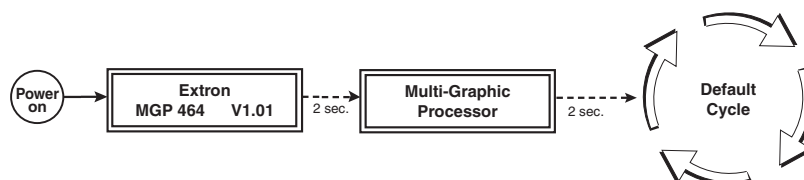

Power-up cycle flow diagram

Using a Web browser

The MGP 464 comes from the factory with a set of default embedded Web pages. The System Status Web page displays the firmware version of your unit, along with other information such as your MGP's IP address and part number.

To use the Web pages to find out the current firmware version number,

1. Connect the MGP 464 to a PC via an Ethernet connection (using a crossover cable), or connect the MGP and the PC to a network/LAN (using a straight-through cable). See "Rear Panel Features" in chapter 2 for details.
2. Start a Web browser program (such as Microsoft® Internet Explorer).
3. Enter the MGP 464's IP address in the browser's Address field.

NOTE *If your local system administrators have not changed the value, use the factory-specified default, 192.168.254.254, for this field.*

4. Press the Enter key. If the MGP 464's HTML pages are not password protected, the browser displays the System Status page.

If the MGP 464's HTML pages are password protected, the browser displays the Enter Network Password dialog box, shown on the next page.

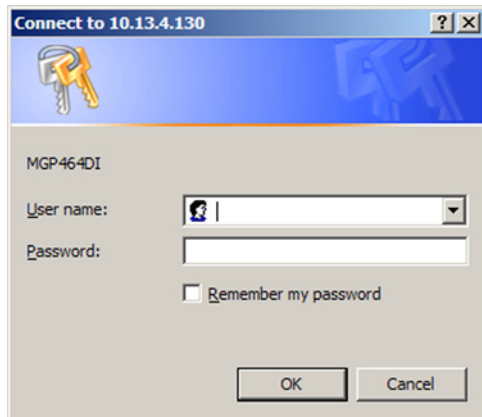

Example of an Enter Network Password dialog box

- a. Enter the appropriate administrator password in the Password field.
 - NOTE** A User name entry is not required.
 - b. If desired, select the check box to have the system input your password the next time you enter your MGP 464's IP address.
 - c. Click **OK**. The System Status page or your custom start page opens.
5. Access the System Status page if it is not already displayed. The firmware version is listed in the System Description area, on the third line, to the right of the part number.

System Status Web page

Firmware Upgrade Guide, cont'd

Using the Windows-based configuration software

A third way to find out the firmware version is to access the MGP 464 Windows-based configuration software.

1. Open the configuration software. (See “Windows®-based Control Software,” in chapter 4, for the procedure.)
2. From the Help menu, select About... . The following screen appears, providing information about the current MGP version.

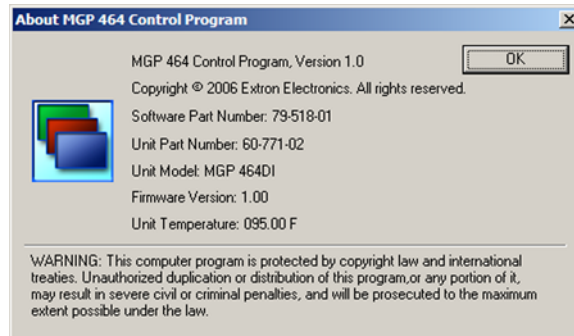

About... screen

3. When finished viewing the information, click OK to close the window.

Downloading the firmware

Obtain the latest version of MGP 464 firmware by downloading it from the Extron Web site, as follows:

1. Visit the Extron Web site (www.extron.com) and click the **Download** tab.
2. On the Download Center page, click the **Firmware** link on the left sidebar menu.
3. On the Firmware page, scroll down to the “MGP 464” line; or click the letter **M** in the alphabet displayed across the top of the page to display products whose names start with M.
4. Click the **Download** link located at the far right of the MGP 464 line.

NOTE *The firmware file applies to both the MGP 464 and the MGP 464W, standard and DI versions.*

5. On the next page, fill in the required information, then click the **Download_MGP464_FWNxNN.exe** button (*N.NN* indicates the firmware version number). A File Download - Security Warning window is displayed.
6. Click **Save**. A Save As window opens.
7. Browse to the folder where you want to save the firmware installation file on your computer, and click **Save**.
8. When ready to install the new firmware, locate the downloaded file, and double-click on it to open it.
9. Follow the instructions on the Installation Wizard screens to install the new firmware on your computer. A Release Notes file, giving information on what has changed in the new firmware version, and a set of instructions for updating the firmware are also loaded.

Updating the Firmware

After you have installed the new firmware on your computer, you must upload it to the MGP 464. Firmware uploads can be performed via a Web browser, the MGP 464's internal Web pages, or the Firmware Loader software. The computer and the MGP 464 must both be connected to an Ethernet network in order to update the main firmware. Unless you are using the Firmware Loader (see "Using the Firmware Loader," later in this chapter), it is recommended that you always perform firmware upgrades via an IP connection.

NOTE Check the Extron Web site for firmware-related documents, instructions, patch files, and new firmware files before loading new firmware into the unit.

Updating using the Web pages

Follow these steps to update the firmware using the MGP 464 Web pages.

1. Launch a Web browser (for example, Internet Explorer) on the connected computer, and enter the MGP's IP address in the address field.
2. If no password has been assigned, the MGP 464 Web page opens, displaying the System Status tab.

If an administrator password has been assigned to the MGP, the Enter Network Password dialog box opens (shown below). Enter the administrator password in the Password field (a User name is not required), and click **OK**. The MGP 464 Web page appears.

NOTE Passwords must contain 4 to 12 alphanumeric characters. Symbols and spaces are not allowed, and the passwords are case sensitive.

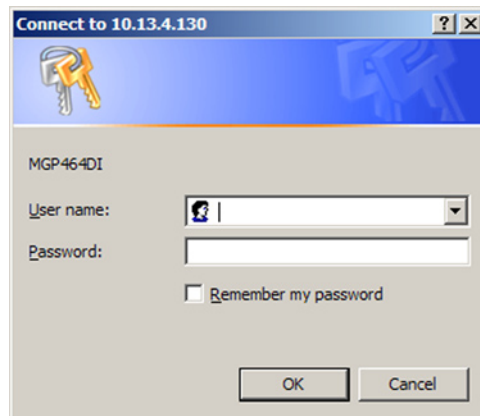

Enter Network Password dialog box

3. On the MGP 464's **Configuration** tab, select **Firmware Upgrade** from the sidebar menu to display the Firmware Upgrade screen.

Firmware Upgrade Guide, cont'd

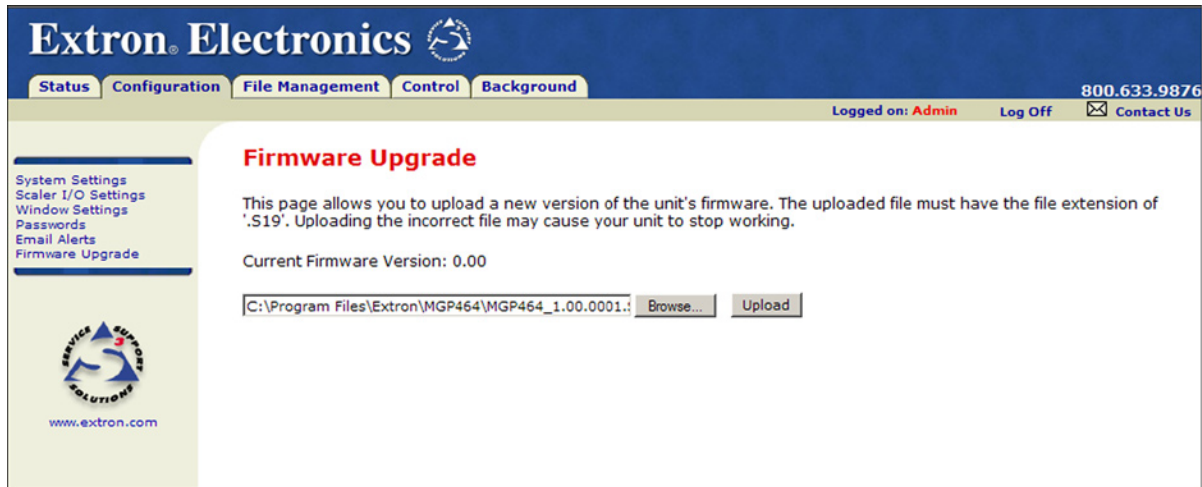

Firmware Upgrade screen

- Click **Browse** to open the Choose file window, and locate the firmware file on your computer or server. The file extension must be **.S19**.

CAUTION *Uploading a file with an incorrect extension may cause the unit to stop working.*

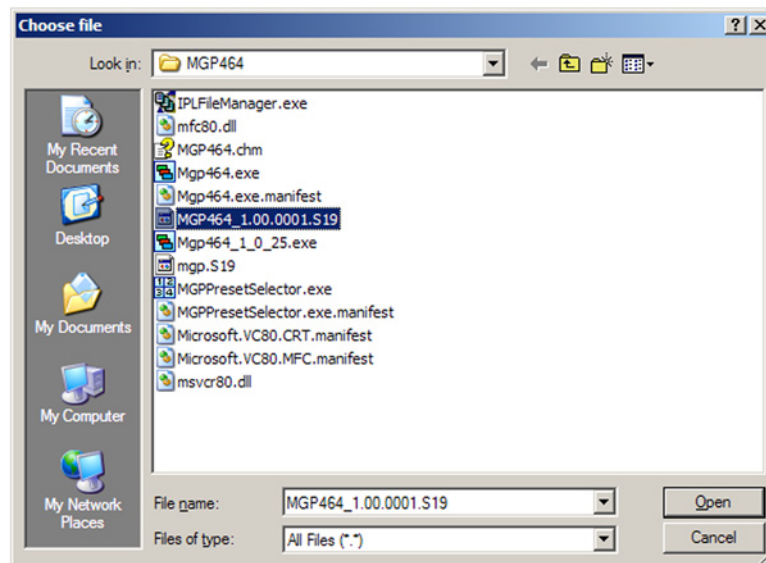

Choose file window with firmware file selected

- Open the firmware file. Its name appears in the field below the Current Firmware Version on the Firmware Upgrade screen.

- Click the **Upload** button on the Firmware Update screen to start the firmware update process. While the firmware is being uploaded, the **Upload** button changes to **Uploading...**; and the LCD window on the MGP displays first "Firmware Upload Please Wait!!!" then "Firmware Reboot Please Wait!!!"

NOTE While the firmware is uploading and rebooting, do not press any front panel buttons or make any selections on the Web pages.

When the uploading process is complete, the **Uploading...** button on the screen changes back to **Upload**.

When the update is complete, the new firmware version number is displayed in the Current Firmware Version field. The LCD screen on the unit displays the first screen that appears on power-up, containing the new firmware version number.

- If you want to further verify that the new version has been loaded, click the Status tab and view the current firmware version on the System Status screen.

Updating using the Windows-based control software

To update the firmware on the MGP 464 using the Windows-based control software,

- Open the Windows-based control software, using an IP connection. See "Windows®-based Control Software" in chapter 4, "Software Configuration and Control," for information on accessing this program.
- From the Options menu, select **Update Firmware...** . An Open window appears.

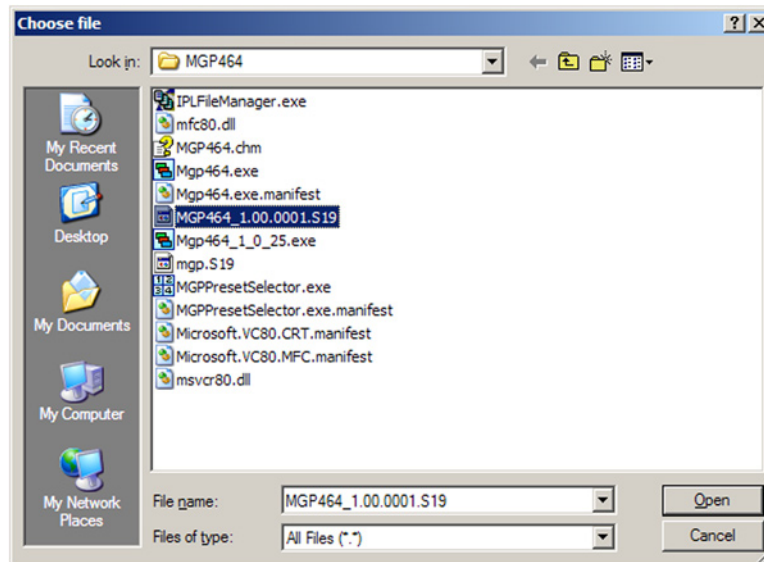

Open window with firmware file selected

- Browse to locate the firmware file that you saved to your computer. **The file extension must be .S19.**

CAUTION Uploading a file with an incorrect extension may cause the unit to stop working.

Firmware Upgrade Guide, cont'd

4. Double-click on the firmware file icon. The firmware uploading process begins. While the firmware is loading, a progress bar is displayed:

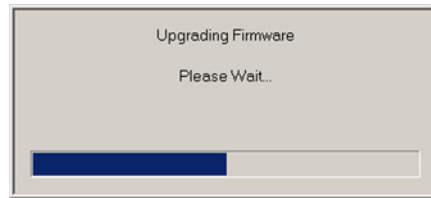

Firmware update progress bar

5. When the firmware update is complete, the progress bar closes.

Updating using the Firmware Loader

An alternative way to update the MGP's firmware is to download and run the Firmware Loader software.

1. Download the Firmware Loader installer executable file to your computer.
 - a. On the Extron Web page, click the **Download** tab.
 - b. On the Download Center page, click **Software** on the left sidebar menu.
 - c. Locate the "Firmware Loader" line and click the **Download** link at the far right.
 - d. Follow the instructions on the download screens to save the installer file to your computer.
2. Locate the Firmware Loader executable file in your computer's file system and open it.
3. Follow the instructions on the Installation Wizard screens to install the Firmware Loader on your computer. The installer program places the Firmware Loader file, "FWLoader.exe" at the following location:
c:\Program Files\Extron\FWLoader
(If the Extron and FWLoader folders do not yet exist in your Program Files folder, the installer creates them.)
4. Access the FWLoader.exe file via your desktop Start menu by making the following selections:
Start > All Programs > Extron Electronics > Firmware Loader > Firmware Loader
5. On the first screen that appears, select the tab for the desired connection type and enter the parameters for your MGP, and click **OK**.

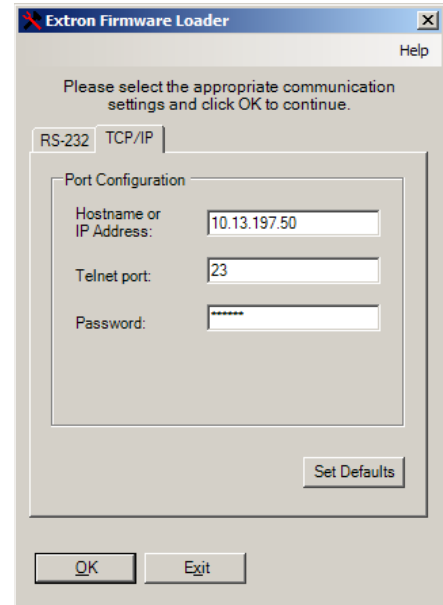
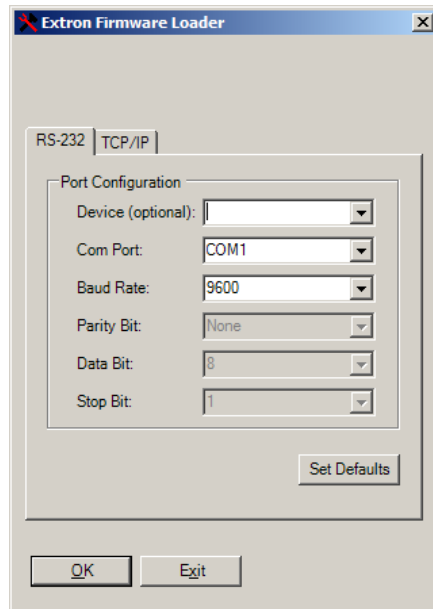

Firmware Loader connection tabs

- **RS-232 tab** — From the drop-down menus, select the appropriate COM port number (obtained from your system administrator) and baud rate (the default is 9600).
 - **TCP/IP tab** — Enter your MGP's IP address (obtained from your system administrator), Telnet port (the default is 23), and, if required, password.
6. In the **Select a firmware file** field on the next screen, enter the path to the new MGP firmware file on your computer, or click **Browse** to locate and open it. (By default, the firmware file is placed at `c:\Extron\Firmware\MGP464` when downloaded from the Extron Web site.)

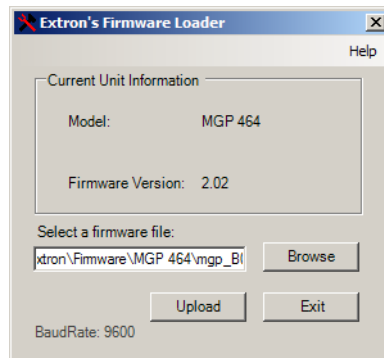

Firmware Loader file selection screen

7. Click **Upload**. Messages appear on the firmware file selection window indicating when the unit is uploading the firmware, then resetting itself. When the firmware upload process is completed, the message "Transfer Complete!" is displayed, and the new firmware version number appears in the Current Unit Information field.
8. Click **Exit** to close the Firmware Loader.

Firmware Upgrade Guide, cont'd

Extron's Warranty

Extron Electronics warrants this product against defects in materials and workmanship for a period of three years from the date of purchase. In the event of malfunction during the warranty period attributable directly to faulty workmanship and/or materials, Extron Electronics will, at its option, repair or replace said products or components, to whatever extent it shall deem necessary to restore said product to proper operating condition, provided that it is returned within the warranty period, with proof of purchase and description of malfunction to:

**USA, Canada, South America,
and Central America:**

Extron Electronics
1001 East Ball Road
Anaheim, CA 92805
U.S.A.

Japan: Extron Electronics, Japan
Kyodo Building, 16 Ichibancho
Chiyoda-ku, Tokyo 102-0082
Japan

Europe, Africa, and the Middle East:

Extron Europe
Hanzeboulevard 10
3825 PH Amersfoort
The Netherlands

China:

Extron China
686 Ronghua Road, Songjiang
District
Shanghai 201611
China

Asia:

Extron Asia
135 Joo Seng Road, #04-01
PM Industrial Bldg.
Singapore 368363
Singapore

Middle East:

Extron Middle East
Dubai Airport Free Zone
F12, PO Box 293666
United Arab Emirates, Dubai

This Limited Warranty does not apply if the fault has been caused by misuse, improper handling care, electrical or mechanical abuse, abnormal operating conditions or non-Extron authorized modification to the product.

If it has been determined that the product is defective, please call Extron and ask for an Applications Engineer at (714) 491-1500 (USA), 31.33.453.4040 (Europe), 65.383.4400 (Asia), or 81.3.3511.7655 (Japan) to receive an RA# (Return Authorization number). This will begin the repair process as quickly as possible.

Units must be returned insured, with shipping charges prepaid. If not insured, you assume the risk of loss or damage during shipment. Returned units must include the serial number and a description of the problem, as well as the name of the person to contact in case there are any questions.

Extron Electronics makes no further warranties either expressed or implied with respect to the product and its quality, performance, merchantability, or fitness for any particular use. In no event will Extron Electronics be liable for direct, indirect, or consequential damages resulting from any defect in this product even if Extron Electronics has been advised of such damage.

Please note that laws vary from state to state and country to country, and that some provisions of this warranty may not apply to you.

Extron **USA - West**
Headquarters
+800.633.9876
Inside USA / Canada Only
+1.714.491.1500
+1.714.491.1517 FAX

Extron **USA - East**
+800.633.9876
Inside USA / Canada Only
+1.919.863.1794
+1.919.863.1797 FAX

Extron **Europe**
+800.3987.6673
Inside Europe Only
+31.33.453.4040
+31.33.453.4050 FAX

Extron **Asia**
+800.7339.8766
Inside Asia Only
+65.6383.4400
+65.6383.4664 FAX

Extron **Japan**
+81.3.3511.7655
+81.3.3511.7656 FAX

Extron **China**
+400.883.1568
Inside China Only
+86.21.3760.1568
+86.21.3760.1566 FAX

Extron **Middle East**
+971.4.2991800
+971.4.2991880 FAX

Free Manuals Download Website

<http://myh66.com>

<http://usermanuals.us>

<http://www.somanuals.com>

<http://www.4manuals.cc>

<http://www.manual-lib.com>

<http://www.404manual.com>

<http://www.luxmanual.com>

<http://aubethermostatmanual.com>

Golf course search by state

<http://golfingnear.com>

Email search by domain

<http://emailbydomain.com>

Auto manuals search

<http://auto.somanuals.com>

TV manuals search

<http://tv.somanuals.com>