

Precautions

Safety Instructions • English



This symbol is intended to alert the user of important operating and maintenance (servicing) instructions in the literature provided with the equipment.



This symbol is intended to alert the user of the presence of uninsulated dangerous voltage within the product's enclosure that may present a risk of electric shock.

Caution

Read Instructions • Read and understand all safety and operating instructions before using the equipment.

Retain Instructions • The safety instructions should be kept for future reference.

Follow Warnings • Follow all warnings and instructions marked on the equipment or in the user information.

Avoid Attachments • Do not use tools or attachments that are not recommended by the equipment manufacturer because they may be hazardous.

Consignes de Sécurité • Français



Ce symbole sert à avertir l'utilisateur que la documentation fournie avec le matériel contient des instructions importantes concernant l'exploitation et la maintenance (réparation).



Ce symbole sert à avertir l'utilisateur de la présence dans le boîtier de l'appareil de tensions dangereuses non isolées posant des risques d'électrocution.

Attention

Lire les instructions • Prendre connaissance de toutes les consignes de sécurité et d'exploitation avant d'utiliser le matériel.

Conservier les instructions • Ranger les consignes de sécurité afin de pouvoir les consulter à l'avenir.

Respecter les avertissements • Observer tous les avertissements et consignes marqués sur le matériel ou présentés dans la documentation utilisateur.

Eviter les pièces de fixation • Ne pas utiliser de pièces de fixation ni d'outils non recommandés par le fabricant du matériel car cela risquerait de poser certains dangers.

Sicherheitsanleitungen • Deutsch



Dieses Symbol soll dem Benutzer in der im Lieferumfang enthaltenen Dokumentation besonders wichtige Hinweise zur Bedienung und Wartung (Instandhaltung) geben.



Dieses Symbol soll den Benutzer darauf aufmerksam machen, daß im Inneren des Gehäuses dieses Produktes gefährliche Spannungen, die nicht isoliert sind und die einen elektrischen Schock verursachen können, herrschen.

Achtung

Lesen der Anleitungen • Bevor Sie das Gerät zum ersten Mal verwenden, sollten Sie alle Sicherheits- und Bedienungsanleitungen genau durchlesen und verstehen.

Aufbewahren der Anleitungen • Die Hinweise zur elektrischen Sicherheit des Produktes sollten Sie aufbewahren, damit Sie im Bedarfsfall darauf zurückgreifen können.

Befolgen der Warnhinweise • Befolgen Sie alle Warnhinweise und Anleitungen auf dem Gerät oder in der Benutzerdokumentation.

Keine Zusatzgeräte • Verwenden Sie keine Werkzeuge oder Zusatzgeräte, die nicht ausdrücklich vom Hersteller empfohlen wurden, da diese eine Gefahrenquelle darstellen können.

Instrucciones de seguridad • Español



Este símbolo se utiliza para advertir al usuario sobre instrucciones importantes de operación y mantenimiento (o cambio de partes) que se desean destacar en el contenido de la documentación suministrada con los equipos.



Este símbolo se utiliza para advertir al usuario sobre la presencia de elementos con voltaje peligroso sin protección aislante, que puedan encontrarse dentro de la caja o alojamiento del producto, y que puedan representar riesgo de electrocución.

Precaución

Leer las instrucciones • Leer y analizar todas las instrucciones de operación y seguridad, antes de usar el equipo.

Conservar las instrucciones • Conservar las instrucciones de seguridad para futura consulta.

Obedecer las advertencias • Todas las advertencias e instrucciones marcadas en el equipo o en la documentación del usuario, deben ser obedecidas.

Evitar el uso de accesorios • No usar herramientas o accesorios que no sean específicamente recomendados por el fabricante, ya que podrían implicar riesgos.

Warning

Power sources • This equipment should be operated only from the power source indicated on the product. This equipment is intended to be used with a main power system with a grounded (neutral) conductor. The third (grounding) pin is a safety feature, do not attempt to bypass or disable it.

Power disconnection • To remove power from the equipment safely, remove all power cords from the rear of the equipment, or the desktop power module (if detachable), or from the power source receptacle (wall plug).

Power cord protection • Power cords should be routed so that they are not likely to be stepped on or pinched by items placed upon or against them.

Servicing • Refer all servicing to qualified service personnel. There are no user-serviceable parts inside. To prevent the risk of shock, do not attempt to service this equipment yourself because opening or removing covers may expose you to dangerous voltage or other hazards.

Slots and openings • If the equipment has slots or holes in the enclosure, these are provided to prevent overheating of sensitive components inside. These openings must never be blocked by other objects.

Lithium battery • There is a danger of explosion if battery is incorrectly replaced. Replace it only with the same or equivalent type recommended by the manufacturer. Dispose of used batteries according to the manufacturer's instructions.

Avertissement

Alimentations • Ne faire fonctionner ce matériel qu'avec la source d'alimentation indiquée sur l'appareil. Ce matériel doit être utilisé avec une alimentation principale comportant un fil de terre (neutre). Le troisième contact (de mise à la terre) constitue un dispositif de sécurité: n'essayez pas de le contourner ni de le désactiver.

Déconnexion de l'alimentation • Pour mettre le matériel hors tension sans danger, déconnectez tous les cordons d'alimentation de l'arrière de l'appareil ou du module d'alimentation de bureau (s'il est amovible) ou encore de la prise secteur.

Protection du cordon d'alimentation • Acheminer les cordons d'alimentation de manière à ce que personne ne risque de marcher dessus et à ce qu'ils ne soient pas écrasés ou pincés par des objets.

Réparation-maintenance • Faire exécuter toutes les interventions de réparation-maintenance par un technicien qualifié. Aucun des éléments internes ne peut être réparé par l'utilisateur. Afin d'éviter tout danger d'électrocution, l'utilisateur ne doit pas essayer de procéder lui-même à des opérations car l'ouverture ou le retrait des couvercles risquent de l'exposer à de hautes tensions et autres dangers.

Fentes et orifices • Si le boîtier de l'appareil comporte des fentes ou des orifices, ceux-ci servent à empêcher les composants internes sensibles de surchauffer. Ces ouvertures ne doivent jamais être bloquées par des objets.

Lithium Batterie • Il a danger d'explosion s'il y a remplacement incorrect de la batterie. Remplacer uniquement avec une batterie du même type ou d'un type équivalent recommandé par le constructeur. Mettre au rebut les batteries usagées conformément aux instructions du fabricant.

Vorsicht

Stromquellen • Dieses Gerät sollte nur über die auf dem Produkt angegebene Stromquelle betrieben werden. Dieses Gerät wurde für eine Verwendung mit einer Hauptstromleitung mit einem geerdeten (neutralen) Leiter konzipiert. Der dritte Kontakt ist für einen Erdschluss, und stellt eine Sicherheitsfunktion dar. Diese sollte nicht umgangen oder außer Betrieb gesetzt werden.

Stromunterbrechung • Um das Gerät auf sichere Weise vom Netz zu trennen, sollten Sie alle Netzkabel aus der Rückseite des Gerätes, aus der externen Stromversorgung (falls dies möglich ist) oder aus der Wandsteckdose ziehen.

Schutz des Netzkabels • Netzkabel sollten stets so verlegt werden, daß sie nicht im Weg liegen und niemand darauf treten kann oder Objekte darauf- oder unmittelbar dagegestellt werden können.

Wartung • Alle Wartungsmaßnahmen sollten nur von qualifiziertem Servicepersonal durchgeführt werden. Die internen Komponenten des Gerätes sind wartungsfrei. Zur Vermeidung eines elektrischen Schocks versuchen Sie in keinem Fall, dieses Gerät selbst öffnen, da beim Entfernen der Abdeckungen die Gefahr eines elektrischen Schlags und/oder anderer Gefahren bestehen.

Schlitze und Öffnungen • Wenn das Gerät Schlitze oder Löcher im Gehäuse aufweist, dienen diese zur Vermeidung einer Überhitzung der empfindlichen Teile im Inneren. Diese Öffnungen dürfen niemals von anderen Objekten blockiert werden.

Litium-Batterie • Explosionsgefahr, falls die Batterie nicht richtig ersetzt wird. Ersetzen Sie verbrauchte Batterien nur durch den gleichen oder einen vergleichbaren Batterietyp, der auch vom Hersteller empfohlen wird. Entsorgen Sie verbrauchte Batterien bitte gemäß den Herstelleranweisungen.

Advertencia

Alimentación eléctrica • Este equipo debe conectarse únicamente a la fuente/ tipo de alimentación eléctrica indicada en el equipo. La alimentación eléctrica de este equipo debe provenir de un sistema de distribución general con conductor neutro a tierra. La tercera pata (puesta a tierra) es una medida de seguridad, no puede ser eliminada.

Desconexión de alimentación eléctrica • Para desconectar con seguridad la acometida de alimentación eléctrica al equipo, desenchufar todos los cables de alimentación en el panel trasero del equipo, o desenchufar el módulo de alimentación (si fuera independiente), o desenchufar el cable del receptáculo de la pared.

Protección del cables de alimentación • Los cables de alimentación eléctrica se deben instalar en lugares donde no sean pisados ni apretados por objetos que se puedan apoyar sobre ellos.

Reparaciones/mantenimiento • Solicitar siempre los servicios técnicos de personal calificado. En el interior no hay partes a las que el usuario deba acceder. Para evitar riesgo de electrocución, no intentar personalmente la reparación/ mantenimiento de este equipo, ya que al abrirlo o extraer las tapas puede quedar expuesto a voltajes peligrosos u otros riesgos.

Ranuras y aberturas • Si el equipo posee ranuras o orificios en su caja/alojamiento, es para evitar el sobrecalentamiento de componentes internos sensibles. Estas aberturas nunca se deben obstruir con otros objetos.

Batería de litio • Existe riesgo de explosión si esta batería se coloca en la posición incorrecta. Cambiar esta batería únicamente con el mismo tipo (o su equivalente) recomendado por el fabricante. Desachar las baterías usadas siguiendo las instrucciones del fabricante.

FCC Class A Notice

Note: This equipment has been tested and found to comply with the limits for a Class A digital device, pursuant to part 15 of the FCC Rules. These limits are designed to provide reasonable protection against harmful interference when the equipment is operated in a commercial environment. This equipment generates, uses and can radiate radio frequency energy and, if not installed and used in accordance with the instruction manual, may cause harmful interference to radio communications. Operation of this equipment in a residential area is likely to cause harmful interference, in which case the user will be required to correct the interference at his own expense.

Note: This unit was tested with shielded cables on the peripheral devices. Shielded cables must be used with the unit to ensure compliance.

Extron's Warranty

Extron Electronics warrants this product against defects in materials and workmanship for a period of two years from the date of purchase. In the event of malfunction during the warranty period attributable directly to faulty workmanship and/or materials, Extron Electronics will, at its option, repair or replace said products or components, to whatever extent it shall deem necessary to restore said product to proper operating condition, provided that it is returned within the warranty period, with proof of purchase and description of malfunction to:

USA, Canada, South America, and Central America:

Extron Electronics
1230 South Lewis Street
Anaheim, CA 92805, USA

Europe, Africa, and the Middle East:

Extron Electronics, Europe
Beeldschermweg 6C
3821 AH Amersfoort
The Netherlands

Asia:

Extron Electronics, Asia
135 Joo Seng Road, #04-01
PM Industrial Bldg.
Singapore 368363

This Limited Warranty does not apply if the fault has been caused by misuse, improper handling care, electrical or mechanical abuse, abnormal operating conditions or non-Extron authorized modification to the product.

If it has been determined that the product is defective, please call Extron and ask for an Applications Engineer at (714) 491-1500 (USA), 31.33.453.4040 (Europe), or 65.383.4400 (Asia) to receive an RA# (Return Authorization number). This will begin the repair process as quickly as possible.

Units must be returned insured, with shipping charges prepaid. If not insured, you assume the risk of loss or damage during shipment. Returned units must include the serial number and a description of the problem, as well as the name of the person to contact in case there are any questions.

Extron Electronics makes no further warranties either expressed or implied with respect to the product and its quality, performance, merchantability, or fitness for any particular use. In no event will Extron Electronics be liable for direct, indirect, or consequential damages resulting from any defect in this product even if Extron Electronics has been advised of such damage.

Please note that laws vary from state to state and country to country, and that some provisions of this warranty may not apply to you.

Table of Contents

Chapter 1 • Introduction	1-1
About this Manual	1-2
About the VSC 150	1-2
Features	1-2
Chapter 2 • Installation and Operation	2-1
Installation Overview	2-2
Mounting the VSC 150	2-2
Tabletop/desktop placement	2-2
Rack mounting	2-3
Front Panel Features	2-4
Rear Panel Features	2-7
Cabling	2-9
Mac-HV/VGA cable connector pin assignments	2-12
Optimizing the Image	2-12
Setting Up Genlock and Vertical Interval Switching	2-13
Vertical interval switching setup	2-13
Genlock setup	2-14
Oscilloscope displays	2-16
Troubleshooting	2-17
If the image does not appear	2-17
If the image does not display correctly	2-18
If the scan converter does not respond to controls	2-19
Chapter 3 • Remote Control	3-1
RS-232 RemoteControl	3-2
Host-to-VSC communications	3-2
VSC-initiated messages	3-2
VSC error responses	3-3
Time-out	3-3
Using the command/response table	3-3
Command/response table	3-4
Control software for Windows	3-6
Installing the software	3-6
Using the software	3-6
IR Remote Control	3-7
Using the memory feature	3-8

(Continued)

Table of Contents, cont'd

Appendix • Specifications, Accessories and Part Numbers	A-1
Specifications	A-2
Included Parts	A-4
Accessories	A-4



VSC 150

Chapter One

Introduction

About this Manual

About the VSC 150

Features

68-469-01 D
Printed in the USA
01 01

About this Manual

This manual contains information about Extron's VSC 150 scan converter and how to install, operate and configure it. It also explains how to operate the IR 601 remote control.

About the VSC 150

Extron's VSC 150 is a high resolution computer-to-video scan converter with all digital controls. The VSC 150 converts a computer video signal into two display outputs – composite video and *one* of the following:

- S-video,
- component video, *or*
- RGB video (RGBHV or RGBS)

for simultaneous scan-converted output on two separate devices. This allows the video from a computer to be displayed on a television monitor or recorded on a DVD, VCR, video editing bay or other recording device. All of the outputs are NTSC/PAL.

This scan converter accepts one Macintosh or VGA computer input of a resolution up to 1152 x 900 and provides a local monitor loop-out.

The VSC 150 is 1U high and one half rack wide. It is rack mountable, and has an internal, autoswitching power supply. It can be controlled via front panel buttons, RS-232 remote control, and infrared (IR) control.

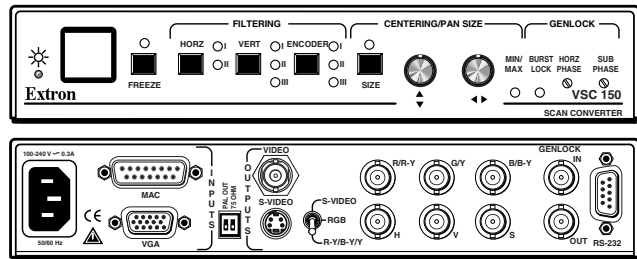

VSC 150 front and rear panels

Features

Picture sizing/zoom controls — Separate digital rotary controls on the VSC 150 allow horizontal and/or vertical picture resizing to fit the display device or zoom in or out. These settings are stored in user-defined memories.

Picture centering and panning — Center the picture horizontally and vertically or pan across the picture with these front panel rotary controls.

Freeze mode — This feature provides a still image of the scan-converted picture.

Filtering controls — Horizontal, vertical and encoder filtering levels are user-selectable from the front panel or remote controls for control of picture detail clarity and flicker reduction.

Memory presets — The VSC 150 offers 30 factory-defined and 30 user-defined presets for size, zoom, panning, centering and filtering settings. These settings can be recalled automatically in association with a particular input signal scan rate. Three additional user-defined presets can be stored and retrieved manually via IR or RS-232 remote control.

Executive mode — To prevent unauthorized or accidental adjustments to the VSC 150's settings via front panel controls, Executive mode locks all the front panel features except centering controls. Adjustments can still be made via RS-232 control and IR remote control when executive mode is active.

Infrared (IR) remote control — All the functions that can be controlled via front panel controls can be also be controlled via an IR remote control.

RS-232 control — The VSC 150 can also be controlled via computer or another control device through an RS-232 connection and Extron's Simple Instruction Set™ (SIS™) or the Extron graphical control program for Windows®.

Choice of output formats — NTSC/PAL composite video output is continuously available on a rear panel BNC connector. In addition, *one* other output can also be active. Choose from the following formats via a rear panel switch and cable connections:

- RGBHV (separate horizontal and vertical sync),
- RGBS (composite sync),
- Y, R-Y, B-Y (component video), or
- S-video output.

Genlock (burst lock) synchronization — The VSC 150 can be connected to a genlock (burst lock/black burst) sync signal generator via rear panel connectors, and the phase differences between the genlock sync and output video sync can be adjusted separately for the

horizontal and color subcarrier signals. Genlocking provides for seamless vertical interval switching between the scan-converted signal and signals from other video sources.

VGA or Macintosh input and local monitor output — The 15-pin HD and 15-pin D connectors allow easy connection to a PC or Mac local monitor. The included male Mac-VGA cable connects the VSC 150 to the computer without need for additional adapters.

Rack mountability — The VSC 150 can be rack mounted on one side of an optional 1U rack shelf (Extron part #60-190-01).



VSC 150

Chapter Two

Installation and Operation

Installation Overview

Mounting the VSC 150

Front Panel Features

Rear Panel Features

Cabling

Optimizing the Image

Setting Up Genlock and Vertical Interval Switching

Troubleshooting

Installation Overview

To install and set up the VSC 150, follow these basic steps:

- 1 Turn all of the equipment off. Make sure that the source computer, the VSC 150, the output devices (projector, monitors), genlock device (black burst generator), and remote control devices are turned off and disconnected from the power source.
- 2 Mount the scan converter. See "Mounting the VSC 150" in this chapter.
- 3 Set the rear panel toggle and DIP switches. See "Rear Panel Features" in this chapter for details.
- 4 Attach the cables. See "Cabling" and "Rear Panel Features" in this chapter.
- 5 Connect power cords and turn on all the equipment.
- 6 The image should now appear. If not, ensure that all devices are plugged in and receiving power. Check the cabling and rear panel switches, and make adjustments as needed. See "Troubleshooting" in this chapter if needed.
- 7 Using an oscilloscope, set up and adjust the genlock signal. See "Setting Up Genlock and Vertical Interval Switching" in this manual.
- 8 Adjust filtering and other settings from the front panel buttons, or RS-232 or IR remote controller. See "Front Panel Features" in this chapter for details. See "Troubleshooting" in this chapter if needed.

Mounting the VSC 150

Select tabletop placement or rack mounting. Follow the appropriate installation instructions on these two pages.

Tabletop/desktop placement

For tabletop or desktop placement only, install the self-adhesive rubber feet/pads (provided) onto the four corners of the bottom of the enclosure.

Rack mounting

1. If feet were installed on the bottom of the VSC 150, remove them.
2. Place the VSC 150 on one half of the 1U (one unit high, one unit wide) rack shelf (part #60-190-01). Align the front of the VSC 150 with the front of the shelf, and align the threaded holes on the bottom of the VSC 150 with the holes in the rack shelf.
3. Attach the VSC 150 to the rack shelf with the two provided 4-40 x 1/8" machine screws. Insert the screws from the underside of the shelf, and securely fasten them into diagonally-opposite corners as shown in the illustration below.

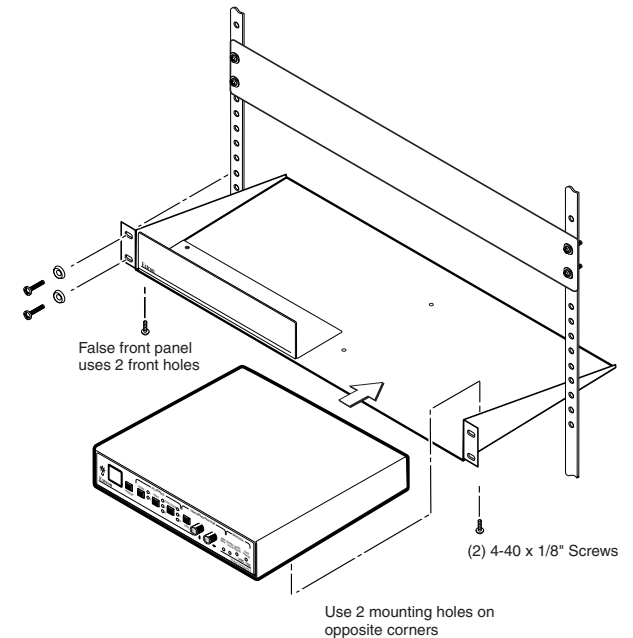

Rack mounting

4. Attach the false front panel (provided with the rack shelf) to the unoccupied side of the rack (as shown above), or install a second half-rack-width device in that side by repeating steps 1 – 3.
5. Attach the rack shelf to the rack using four 10-32 x 3/4" bolts (provided). Insert the bolts through #10 beveled washers, then through the holes in the rack ears and rack, as shown above.

Front Panel Features

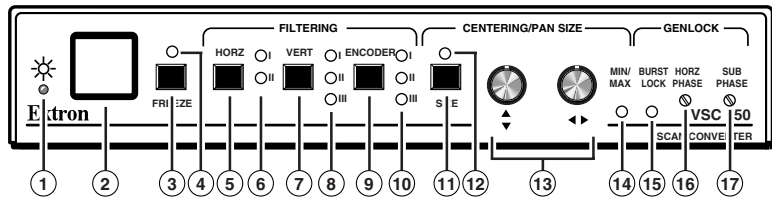

NOTE Adjustments to front panel features and controls do not affect the local monitor.

- ① **Power/signal lock LED** — If this indicator...
 - **Lights amber yellow without blinking**, the VSC 150 is receiving power, but no input signal is present.
 - **Blinks green**, the unit is receiving power, but the input signal has a resolution that is too low or too high.
 - **Blinks green** when the signal is within range, the VSC 150 is receiving commands from the IR 601 remote control.
 - **Lights green** without blinking, the input signal is within range, and the VSC 150 has locked to that particular resolution.
- ② **IR receiver window** — The VSC 150 receives infrared signals from the IR remote controller through this window. The IR remote controller must be in the direct line of sight of this window when it is in use.
- ③ **Freeze control** — Press this button to display (or record) a still image of the scan-converted picture from both display outputs. (See “Rear Panel Features” and “Cabling” for information on these outputs.) The freeze LED indicator lights while this control is active. To turn this feature off, press the Freeze button again. Freeze affects both outputs simultaneously. No matter what the format is (RGB, component, S-video or composite video), the image will be “frozen”. The image on the local monitor will not be “frozen”.

NOTE All controls *except* Freeze will be locked on both the front panel and the IR remote control while Freeze mode is active. Press the Freeze button again to turn off Freeze mode and unlock the other controls.

- ③+⑪ **Executive mode (Freeze + Size)** — Press the Freeze control together with the Size button for

2 seconds to activate **Executive mode**. Executive mode prevents unauthorized or accidental adjustments to the VSC 150's settings via front panel controls by locking all the front panel features except centering controls. Adjustments can still be made via RS-232 control or IR remote control when Executive mode is active. To release Executive mode and allow access to all front panel functions, press the Freeze and Size buttons simultaneously again for 2 seconds.

- ④ **Freeze indicator LED** — This LED lights green to indicate that the freeze feature is active.
- ⑤ **Horizontal (Horz) filtering control** — Press this button to choose between the two levels of horizontal filtering to yield the best picture detail.
- ⑥ **Horizontal filtering LEDs** — These LEDs light yellow to indicate the selected horizontal filtering level.
- ⑦ **Vertical (Vert) filtering control** — Press this button to choose one of the three levels of vertical filtering. Select the setting that yields the least amount of flicker.
- ⑧ **Vertical filtering LEDs** — These LEDs light yellow to indicate the selected level of vertical filtering.
- ⑨ **Encoder filtering control** — Press this button to choose one of the three levels of encoder filters. Select the setting that gives the best picture detail.
- ⑩ **Encoder filtering LEDs** — These LEDs light yellow to indicate the selected level of encoder filtering.
- ⑪ **Size control** — Press this button to activate the size feature. When Size is active, the picture can be resized vertically and/or horizontally by rotating the vertical and horizontal Centering/Pan/Size rotary controls (13). Observe the picture on screen as you adjust the controls. To zoom in, adjust the size so the picture exceeds the screen's limits. The Min/Max LED (14) lights red when the minimum or maximum limit of a control has been reached.

The size feature affects both display outputs simultaneously. The image is resized no matter what format is selected (RGB, component, S-video or composite video). The local monitor loop-out is not affected.

The size function remains active for 8 seconds after the rotary controls become inactive. The rotary controls then

(Continued on the next page)

default to the standard centering and pan functions. To turn the size feature off, press the Size button again.

See Freeze control (3) for information on using Executive mode.

- ⑫ **Size control LED** — This LED lights green to indicate that the size feature is active.
- ⑬ **Vertical (↕) and horizontal (↔) Centering/Pan/Size rotary controls** — Turn these knobs to adjust vertical or horizontal centering (when the image size does not exceed screen size) and panning (when the image size exceeds the screen size) in the regular mode. Rotate these controls to adjust picture size when the Size mode is active.
- ⑭ **Min/Max LED** — This lights red when the minimum or maximum limit of a control (13) has been reached.
- ⑮ **Burst Lock (genlock) LED** — This lights green to indicate that the VSC 150 is receiving a genlock (black burst) sync signal via the rear panel genlock input connector. Genlock is a sync timing reference signal used to synchronize an entire system's components. If this LED does not light when genlock is active, then either further phase adjustment is needed, or a different, more stable or time-base-corrected sync signal must be used for the genlock source.
- ⑯ **Horizontal phase (Horz Phase) control** — During genlock setup use a small screwdriver to rotate this control to align the horizontal phase of the composite video sync signal with that of the genlock signal. See "Setting Up Genlock and Vertical Interval Switching" in this chapter for details.
- ⑰ **Subcarrier phase (Sub Phase) control** — During genlock setup use a small screwdriver to rotate this control to align the color subcarrier phase of the composite video sync signal with that of the genlock signal. See "Setting Up Genlock and Vertical Interval Switching" in this chapter for details.

Rear Panel Features

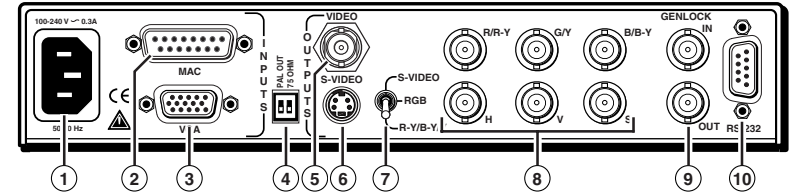

- ① **AC power input connector** — Connect a standard IEC AC power cord here for power input (100VAC to 240VAC, 50/60 Hz).
- ② **VGA computer input/Macintosh local monitor output connector** — Connect a VGA-type computer to the VSC 150 via this 15-pin D connector (and the provided Mac-VGA cable) to use a VGA-type computer as the video signal source. If a Macintosh, instead of a VGA-type PC, is used as a source, this connector serves as the Mac local monitor pass-through output connector.
- ③ **Macintosh (Mac) input/VGA local monitor output connector** — Connect a Macintosh computer to the VSC 150 via this 15-pin HD connector (and the provided Mac-VGA cable) to use a Mac as the video signal source. If a VGA/SVGA-type computer, instead of a Macintosh, is used as a source, this connector serves as the VGA local monitor pass-through output connector.
- ④ **DIP switches** — These two switches select the signal standard (NTSC or PAL) applied to the scan converted video output, and the video input termination (75 ohm or high impedance).
 - 1 — **PAL Out** — Select the output standard with this switch. This switch affects both of the display outputs (composite video and one other), but not the local monitor.
 - ON** — The output is in **PAL** (Phase Alternate Line) format (625 lines/frame at 50 Hz vertical, 15.625 kHz horizontal).
 - OFF** — The output is in **NTSC** (National Television Standards Committee) format (525 lines/frame at 60 Hz vertical, 15.734 kHz horizontal).

(Continued)

2 — **75 Ohm (video input termination)** — This switch provides a way to prevent blooming when no local monitor or termination adapter is connected.

ON — The VSC 150 provides 75 ohm video input termination. Select this setting when a local monitor is not used.

OFF — The VSC 150 provides high Z (high impedance) video input termination. Use this setting when the system includes a local monitor.

⑤ **Composite video (Video) output connector** — Composite video output is continuously available on this BNC connector.

⑥ **S-video output connector** — This 4-pin mini-DIN connector is for S-video output.

⑦ **Output selection switch** — In addition to the composite video output, *one* other output can also be active. Choose from the following formats via the output selection switch:



- S-video output (select S-video),
- RGBS (composite sync) output (select RGB),
- RGBHV (separate horizontal and vertical sync) (select RGB), or
- Y, R-Y, B-Y (component video) output (select R-Y/B-Y/Y).

The output cables must also be connected to the appropriate connector(s) for the second output.

WARNING *Connect cables for only one output in addition to the composite video output. Do not connect cables to outputs that will not be used for your application. Connecting cables to more outputs will overload the circuits and yield weak signals.*

⑧ **RGB/component video output connectors** — These BNC female connectors are for RGB output (red, green, and blue video output; and horizontal, vertical, and composite sync output), or for component video output (R-Y, Y, B-Y). See “Cabling” in this chapter for details.

⑨ **Genlock connectors** — A genlock (black burst generator) device can be connected to the VSC 150 via these female BNC connectors to synchronize it with other system components for seamless vertical interval

switching between sources. See “Cabling” and “Setting Up Genlock and Vertical Interval Switching” in this chapter.

⑩ **RS-232 connector** — Connect a computer or RS-232 control module to this 9-pin D connector to allow remote control using the Simple Instruction Set or the Extron graphical control program for Windows. See chapter 3, “Remote Control” for details.

Cabling

Attach cables to the scan converter as detailed in the steps below. A diagram on page 2-11 shows how the system looks when cabling is finished.

1. Connect the local monitor via its video input cable to the corresponding (Mac or VGA) “input” connector on the VSC 150’s rear panel.
2. Using the included Mac-VGA cable, connect the computer’s video output to the other input connector. See the diagram below and the pin assignment information on page 2-12.
 - If the source computer is a Macintosh, plug the VGA (15-pin HD) end into the VSC 150, and plug the other (15-pin D) end into the computer’s output connector.
 - If the source computer is a VGA-type PC, plug the Mac (15-pin D) end into the VSC 150, and plug the other (15-pin HD) end into the computer’s output connector.

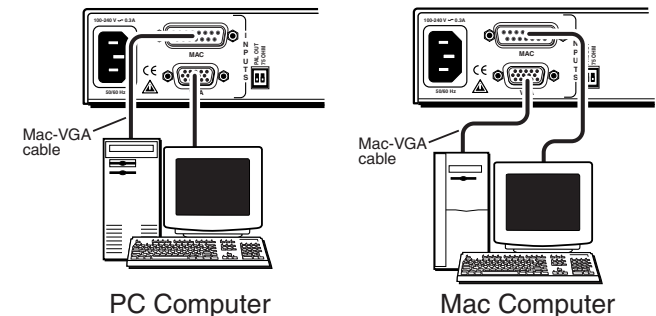

Mac-VGA cable local monitor connections

If a local monitor will not be used, set the 75 Ohm DIP switch to On (75 ohms), or install a termination adapter on the unused local monitor connector.

Installation and Operation, cont'd

- Set the PAL Out (NTSC/PAL output) DIP switch. Use "Rear Panel Features" in this chapter as a guide.
- Connect the composite video display or recording device to the composite video output BNC connector.
- Select the format of the second output by setting the output selection toggle switch.
- Connect a cable from the input of the second video display/recording device (projector, monitor, VCR) to the appropriate VSC 150 rear panel output connectors.

For **S-video**, connect the cable to the 4-pin mini-DIN connector.

For **RGBHV** (separate H and V sync) output, connect coaxial cables to the BNC connectors labeled R/R-Y, G/Y, B/B-Y, H and V, as shown below.

For **RGBS** (composite sync), connect the coax cables to the R/R-Y, G/Y, B/B-Y, and S connectors, as shown below.

For **component video**, connect the coax cables to the R/R-Y, G/Y, B/B-Y connectors as shown below.

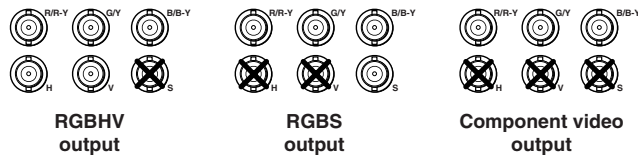

Video output BNC cable connections

WARNING

Connect cables for only one output in addition to the composite video output. Do not connect cables to outputs that will not be used for your application. Connecting cables to more outputs will overload the circuits and yield weak signals.

- Connect the coax cable from the genlock device (or the genlock output of another device that shares the genlock signal) to the Genlock In BNC connector. If no genlock device will be used, do not attach cables to these connectors.

If another device in the system will use genlock, connect the device to the Genlock Out BNC connector of the VSC 150 as shown in the illustration on the next page. Otherwise, attach a termination adapter to the Genlock Out connector. If the genlock signal is connected to several devices in a daisy chain

configuration, the last device must provide genlock termination. See "Setting Up Genlock and Vertical Interval Switching" in this chapter.

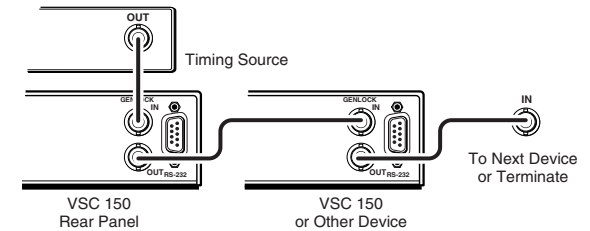

Connecting genlock cables in a daisy chain

- If RS-232 control will be used, connect the RS-232 remote controller or computer to the RS-232 connector.
- Connect power cords and turn on all the equipment.

The system is now ready for operation.

The illustration below shows typical system installation and cable connections.

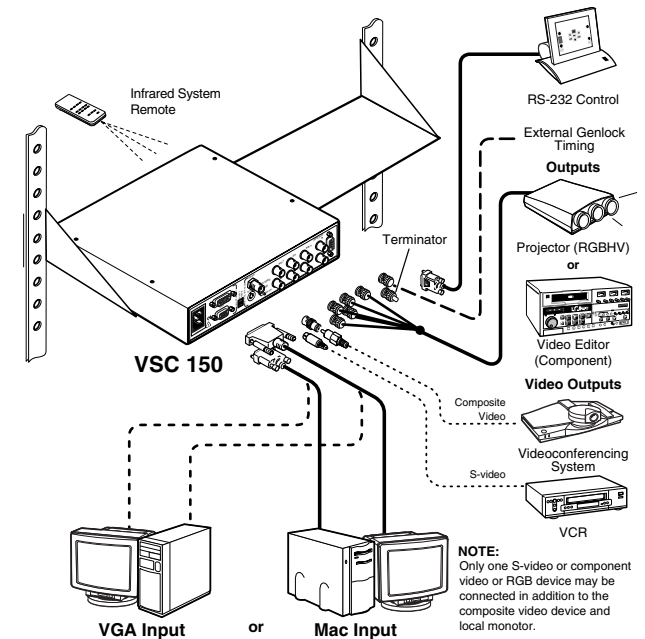

A typical VSC 150 system application

Mac-HV/VGA cable connector pin assignments

The illustration below shows the pin locations on the 15-pin connectors at opposite ends of the Mac-HV/VGA cable that is used for connecting the computer to the VSC 150.

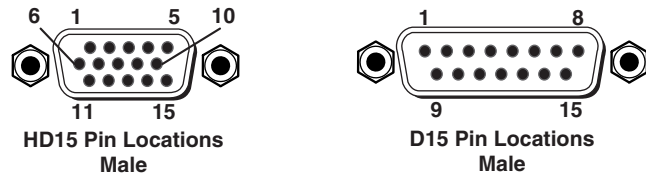

VGA (15-pin HD) and Mac (15-pin D) connector pin locations

The table below lists signals and their pin assignments for both the VGA (15-pin HD) and Mac (15-pin D) connectors of this cable.

VGA Pin	Function	Mac Pin
1	Red video	2
2	Green video	5
3	Blue video	9
4	ID bit	4
5	ID bit	8
6	Red ground	1
7	Green ground	6
8	Blue ground	13
9	Not used	—
10	Composite & vertical sync gnd	11, 14
11	ID bit	7
12	ID bit	10
13	Horizontal sync	15
14	Vertical sync	12
15	ID bit/composite sync	3

Optimizing the Image

After you have installed the scan converter, follow the procedures in this section *in sequence*. This will help you configure the scan converter for the best settings for your display environment.

Select the output standard

1. Select the output standard with the PAL Out DIP switch. This switch affects both display outputs (com-

posite video and one other), but not the local monitor.

ON — The output is in PAL format.

OFF — The output is in NTSC format.

Size the image to fill the screen

1. Press the Size button on the front panel.
2. Rotate the vertical and horizontal Centering/Pan/Size rotary controls to adjust the vertical and horizontal size. Observe the picture on screen as you adjust the controls. The Min/Max LED will light red when the minimum or maximum limit of a control is reached.

The size feature affects both display outputs, but local monitor loop-out is not affected. The size function remains active for 8 seconds after the rotary controls become inactive. The rotary controls then default to the standard centering and pan functions.
3. Press the Size button again to turn the size feature off.
4. Center the picture by rotating the vertical and horizontal Centering/Pan/Size rotary controls.
5. Repeat steps 1 through 4 as needed.

Select the filtering levels

1. Press the horizontal, vertical and encoder filtering controls to select the filtering levels that give the best picture sharpness and the least amount of flickering. The LEDs next to each control will light to indicate the selected level of filtering.

NOTE *If the filters are set before the image size is adjusted, you must set the filters again after adjusting the image size.*

Setting Up Genlock and Vertical Interval Switching

A genlock (black burst generator) device can be connected to the VSC 150 to synchronize it with other system components for seamless vertical interval switching between sources.

Vertical interval switching setup

For vertical interval switching (to allow clean switching between signals from several devices during the vertical blanking period of each signal), a composite sync signal can be applied at the Genlock In connector, and also passed to another device via the Genlock Out connector.

If the genlock connectors are used only for vertical interval switching, no horizontal or subcarrier phase adjustments are required, and the Burst Lock LED does not light.

Genlock setup

Genlock differs from simple vertical interval switching in that an external device (a black burst generator) generates a reference sync signal for the system, and every device that uses that signal has its output signal's horizontal and subcarrier phases adjusted to exactly match that of the generator to allow precise timing and full synchronization. Genlocked systems produce cleaner switches between inputs than do those without this type of synchronization.

An oscilloscope is required for genlock setup, and a vector-scope is recommended. Waveform monitors of types other than a vectorscope may give the appearance that timing is adjusted correctly when it is 180 degrees out of phase, which will result in incorrect colors or picture artifacts.

NOTE *All equipment in the system must be powered up and turned on for at least 15 to 20 minutes before genlock setup adjustments can be made and before the equipment is used in a genlocked application.*

To synchronize the VSC 150's video output with a genlock signal, follow these steps:

1. Power up and turn on all the devices that will use the genlock signal. The devices must be on for at least 15 to 20 minutes before proceeding with any adjustments.

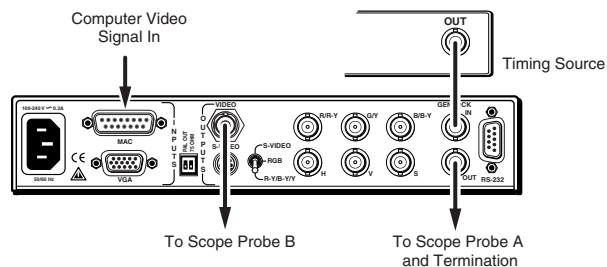

Cable connections for genlock setup

2. Connect the active timing source signal to the Genlock In connector on the rear panel.
3. Connect the active computer video input signal to the appropriate input as explained in step 2 of the Cabling section on page 2-9. Ensure that the input is properly terminated either by connecting a local monitor or a

termination adapter to the other "input" connector, or by setting the 75 Ohm DIP switch to On (75 ohms). The Burst Lock LED lights green to indicate that the VSC 150 is receiving an acceptable genlock (black burst) sync signal via the Genlock In connector.

4. Connect oscilloscope ("scope") probe A to the Genlock Out connector. This will provide the scope's reference signal. In order to avoid altering the genlock signal, use the cabling configuration that will be used in the installation. Either connect the genlock signal cable from the scope to the next device in the system to be timed, or provide 75 ohm termination at the scope's genlock output.
5. Connect scope probe B to the VSC 150's composite video output connector. Ensure that the rear panel PAL Out DIP switch is set for the desired standard (NTSC/PAL).
6. Using the instructions for the scope you are using, set the scope to view the signals' horizontal phases. Adjust the VSC 150's Horz Phase control until there is no (0°) difference between the composite video output's horizontal sync phase and the genlock signal's horizontal phase. See "Oscilloscope displays".
7. Set the scope to view the subcarrier signals. Adjust the VSC 150's Sub Phase control until there is a zero phase difference between the genlock signal and the NTSC/PAL output. The Burst Lock LED should light.

NOTE *If the Burst Lock LED does not light at this point, either adjust the horizontal or subcarrier phases further, or use a different genlock source.*

NOTE *The color subcarrier adjustment range is $\pm 90^\circ$ from 0° for a total adjustment range of 180° .*

8. View the horizontal phases again. If the phase difference is not zero, repeat steps 6 and 7 until the settings do not change.

NOTE *If the Burst Lock LED does not light at all when genlock is active and the horizontal and subcarrier phases have been adjusted to match the genlock signal, do not continue with this procedure. A different, more stable or time-base-corrected sync signal must be used for the genlock timing source.*

9. Once the settings are stable and the Burst Lock LED lights, disconnect the oscilloscope, and reconnect the genlock cables and terminator to the proper devices in the system.

10. Check the display(s) for proper colors and for undesirable artifacts in the image(s). Make adjustments as necessary. Once the genlock timing has been adjusted, it should not require readjustment when changing to a new computer video signal input.
11. If other VSC 150s are part of this genlock daisy chain, connect the oscilloscope to each device, and repeat this procedure.

Oscilloscope displays

What you see on the oscilloscope while adjusting the VSC 150 to match the genlock signal depends on the type of signal used, the type of oscilloscope, and the procedure the scope requires. This section shows some examples of oscilloscope displays.

The figure below shows the genlock input signal (top) and an out-of-alignment NTSC composite sync output signal (bottom) displayed on a waveform monitor to check for alignment. When the phases are aligned, the wave peaks on the bottom waveform should line up with those in the reference signal above it.

With this method there is no way to know if the signals are 180° out of phase. A delayed sweep on a time-based scope would allow a more accurate display of the input and output signal phase relationships.

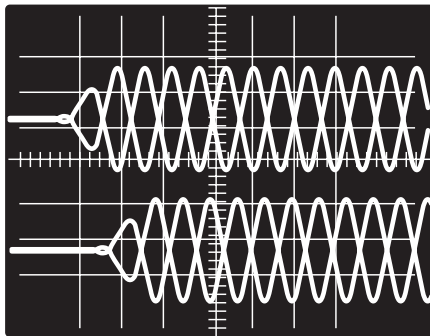

Superimposed waveforms

A vectorscope is more accurate than a waveform monitor. The next figure shows an example of a vectorscope display when the horizontal phase is adjusted to align it with the burst (genlock) vector. Adjust the Horz Phase control until the difference between the two vectors is 0° . This example

shows black burst only (with no color). The burst vector is pointing to the left from the center.

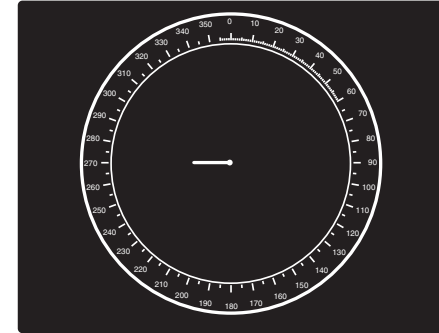

Vectorscope screen during horizontal phase adjustment

The figure below shows an example of a view of a vectorscope during adjustment of the color subcarrier phase (SC/H). The subcarrier phase should be aligned to 0° (indicated in the figure by the triangle).

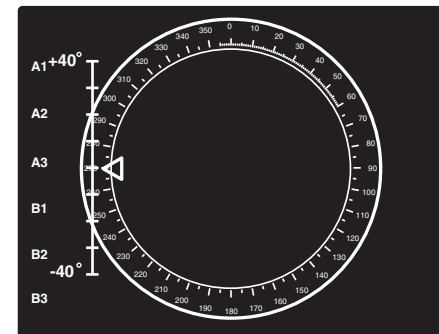

Vectorscope screen during color subcarrier phase adjustment

Troubleshooting

The image should appear properly on the screen(s).

If the image does not appear

1. Ensure that all devices are plugged in.
2. Make sure that each device is receiving power.
3. Check the cabling, wiring and grounding, and make adjustments as needed. Ensure that the rear panel output selection toggle switch and PAL Out DIP switch

Installation and Operation, cont'd

are set for the formats that match the cable configuration and the requirements of the display/recording devices.

4. Verify that the 75 Ohm video input termination DIP switch has been set correctly.
5. To test the system setup and output, substitute a video test generator for the computer input.
6. Confirm that the input is receiving a signal with a compatible scan rate (horizontal frequency between 24 kHz and 70 kHz, and a vertical frequency of 50 Hz to 120 Hz).
7. Call Extron's customer support hotline if needed. Be prepared to discuss the steps you have taken and the equipment involved.

If the image does not display correctly

Symptoms	Solutions
The picture is shifted off the screen edges.	Adjust the centering and sizing controls ().
The image is stable, but it has ghosting or blooming.	Change the 75 ohm/high Z video input termination. If that doesn't solve the problem, use a different input cable.
The picture is faint or cuts out, and the signal is weak.	Video input may be double-terminated. If a local monitor or a termination adapter is attached to the local monitor output connector, make sure that the 75 Ohm video input termination DIP switch is set to Off (for high Z termination). Disconnect all unused output cables. Do not connect cables to both the S-video and RGB/component outputs at the same time.
The picture appears without color.	Adjust the hue/tint and color controls on the display device. Make sure that the video display/recording equipment is using the same standard (NTSC or PAL) as the VSC 150.
In a genlocked system, displayed color is incorrect.	The color subcarrier phase (Sub Phase) might require readjustment.
The image still does not display correctly.	Call Extron's customer support hotline.

If the scan converter does not respond to controls

Symptoms	Solutions
The picture does not move on screen when the horizontal and vertical centering controls are rotated, and the filtering settings do not change when the filtering controls are pressed.	The VSC 150 may be set for Executive mode. Adjustments can be made via RS-232 control, or... Executive mode can be turned off by pressing the Freeze and Size controls simultaneously for 2 seconds. See page 2-4.
The VSC 150 responds to adjustments made via the front panel, but not to selections from the IR remote control.	Signals from the IR 601 remote control may not be reaching the scan converter. Change the placement of the equipment so the signals have a clear transmission path between the remote control and the VSC 150.
There is no response to commands from the RS-232 controller.	Ensure that the baud rate (9600 baud) and communication protocol are set correctly. See page 3-2.



3

Chapter Three

Remote Control

RS-232 Remote Control

IR Remote Control

Remote Control

The VSC 150 can be remotely controlled via a computer or a control panel attached to the rear panel RS-232 connector. Alternatively, the VSC 150 can be controlled using the IR 601 infrared remote control. This chapter discusses how to use each of these options to control the scan converter.

RS-232 Remote Control

The VSC 150 can be controlled by a host computer or other control device via an RS-232 connection with a protocol of 9600 baud, 1 stop bit, no parity, and no flow control. The control device (host) can use either Extron's Simple Instruction Set (SIS) or the graphical control program for Windows.

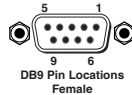

The rear panel RS-232 9-pin D connector has the following pin assignments:

Pin	RS-232 function	Description
1	–	Not used
2	Tx	Transmit data
3	Rx	Receive data
4	–	Not used
5	Gnd	Signal ground
6	–	Not used
7	–	Not used
8	–	Not used
9	–	Not used

Host-to-VSC communications

SIS commands consist of one or more characters per field. No special characters are required to begin or end a command sequence. When the VSC 150 determines that a command is valid, it executes the command and sends a response to the host device. All responses from the scan converter to the host end with a carriage return and a line feed (CR/LF = ↵), which signals the end of the response character string. A string is one or more characters.

VSC-initiated messages

When a local event such as a front panel selection or adjustment takes place, the VSC 150 responds by sending a message to the host. No response is required from the host. The VSC-initiated messages are listed here (underlined).

(C) COPYRIGHT 1999, EXTRON ELECTRONICS, VSC 150, Vx.xx ↵

The VSC 150 displays the copyright message when it first powers on. Vx.xx is the firmware version number.

RECONFIG ↵ The VSC 150 sends the Reconfig message when the input source is changed and when changes have been made to one or more of the settings.

VSC error responses

When the VSC 150 receives a valid SIS command, it executes the command and sends a response to the host device. If the VSC 150 is unable to execute the command because the command is invalid or it contains invalid parameters, it returns an error response to the host. The error response codes and their descriptions are as follows:

E10 – Invalid command

E11 – Invalid preset number

E13 – Invalid value (the number is out of range).

Time-out

A delay of 10 or more seconds between command sequence characters causes a time-out. The command operation is stopped, and there is no indication that a time-out occurred.

Using the command/response table

The command/response table on the next page lists valid command ASCII codes, the VSC 150's responses to the host, a description of the command's function or the results of executing the command, and an example of each command. Lower case characters are acceptable in the command field only where indicated.

The ASCII to HEX conversion table below is for use with the command/response table.

ASCII to HEX Conversion Table												Esc	1B	CR	ØD	LF	ØA		
20	!	21	"	22	#	23	\$	24	%	25	&	26	'	27					
(28)	29	*	2A	+	2B	,	2C	-	2D	.	2E	/	2F				
0	30	1	31	2	32	3	33	4	34	5	35	6	36	7	37				
8	38	9	39	:	3A	;	3B	<	3C	=	3D	>	3E	?	3F				
@	40	A	41	B	42	C	43	D	44	E	45	F	46	G	47				
H	48	I	49	J	4A	K	4B	L	4C	M	4D	N	4E	O	4F				
P	50	Q	51	R	52	S	53	T	54	U	55	V	56	W	57				
X	58	Y	59	Z	5A	[5B	\	5C]	5D	^	5E	–	5F				
`	60	a	61	b	62	c	63	d	64	e	65	f	66	g	67				
h	68	i	69	j	6A	k	6B	l	6C	m	6D	n	6E	o	6F				
p	70	q	71	r	72	s	73	t	74	u	75	v	76	w	77				
x	78	y	79	z	7A	{	7B		7C	}	7D	~	7E	DEL	7F				

Symbol definitions

- ↵ = CR/LF (carriage return/line feed)
- ← = CR (carriage return only)
- = Space
- [X] = Horizontal filtering level (1 through 2)
- [X2] = Vertical filtering level (1 through 3)
- [X3] = Encoder filtering level (1 through 3)
- [X4] = Memory presets (1 through 3)
- [X5] = 1 = On, 0 = Off

Command/response table

Command description	Command ASCII	Command Hex	Response (VSC to host)	Additional description
Horizontal shift				
Shift right one step	{ H	7B + 48	Hph + ↵	Increment up
Shift left one step	} H	7D + 48	Hph - ↵	Increment down
Vertical shift				
Shift down one step	{ /	7B + 2F	Vph + ↵	Increment up
Shift up one step	} /	7D + 2F	Vph - ↵	Increment down
Horizontal size				
Increase horizontal size by one step	{ :	7B + 3A	Hsz + ↵	Increment up
Decrease horizontal size by one step	} :	7D + 3A	Hsz - ↵	Increment down
Vertical size				
Increase vertical size by one step	{ ;	7B + 3B	Vsz + ↵	Increment up
Decrease vertical size by one step	} ;	7D + 3B	Vsz - ↵	Increment down
Horizontal filter (detail)				
Select horizontal filter [X] (Dhz)	[X] D	[X] + 44	Dhz [X] ↵	Specific value
Select next higher horizontal filter (Dhz + 1)	{ D	7B + 44	Dhz [X] ↵	Increment up
Select next lower horizontal filter (Dhz - 1)	} D	7D + 44	Dhz [X] ↵	Increment down

Command description	Command ASCII	Command Hex	Response (VSC to host)	Additional description
Vertical filter (detail)				
Select vertical filter [X2] (Dvt)	[X2] d	[X2] + 64	Dvt [X2] ↵	Specific value
Select next higher vertical filter (Dhz + 1)	{ d	7B + 64	Dvt [X2] ↵	Increment up
Select next lower vertical filter (Dhz - 1)	} d	7D + 64	Dvt [X2] ↵	Increment down
Encoder filter (detail)				
Select encoder filter [X3] (Enc)	[X3] e	[X3] + 65	Enc [X3] ↵	Specific value
Select next higher encoder filter (Enc + 1)	{ e	7B + 65	Enc [X3] ↵	Increment up
Select next lower encoder filter (Enc - 1)	} e	7D + 65	Enc [X3] ↵	Increment down
Memory				
Save preset	[X4]	[X4] 2C	Spr [X4] ↵	
Recall preset	[X4] .	[X4] 2E	Rpr [X4] ↵	
Freeze				
Set Freeze mode to On (freeze the displayed image)	F	46	Frz 1 ↵	Enable freeze
Set Freeze mode to Off (release the displayed image)	f	66	Frz 0 ↵	Disable freeze
Executive mode				
Set Executive mode to On	X	58	Exe 1 ↵	Enable executive
Set Executive mode to Off	x	78	Exe 0 ↵	Disable executive
Firmware version, part number & information requests, and reset				
System reset	Esc z ←	1B 7A 0D	Zap ↵	Reset to factory default
Query firmware version number	Q/q	51/71	Ver xxx ↵	Display firmware version
Request part number	N/n	4E/6E	N60-312-01 ↵	Display VSC 150's part #
Request information	I/i	49/69	(see below)	Display status
Command =	Dhz [X1] • Dvt [X2] • Enc [X3] • Frz [X5] • Exe [X5] ↵			
Response =				

Control software for Windows

The included graphical control software for Windows offers another way to control the VSC 150 via RS-232 connection in addition to the Simple Instruction Set commands listed on pages 3-4 to 3-5. The control software is compatible with Windows 3.1/3.11, Windows 95/98 and Windows NT. The VSC 150 uses version 3.1 or higher of Extron's VSC and DDS Control Program, which is included with the VSC 150.

Installing the software

The control program is contained on a single 3.5-inch diskette, and it can run from the floppy drive. However, it is more convenient to run the program from the hard drive.

To install the software on the hard drive, run SETUP.EXE from the floppy disk, and follow the instructions that appear on the screen. The program requires approximately 1 MB (megabyte) of hard disk space.

By default the installation creates a C:\VSC200 directory, and it places two icons (VSC + DDS Control Pgm and VSC + DDS Help) into a group or folder named "Extron Electronics".

Using the software

- To run the VSC and DDS Control Program, double-click on the VSC + DDS Control Pgm icon in the Extron Electronics group or folder. The Comm menu appears on the screen.
- Click on the comm port that is connected to the VSC 150's RS-232 port. The Extron VSC and DDS Control Program window appears. It displays the current settings. See the illustration on the next page.

For information on program features, press the F1 computer key or click on the Help menu from within the control program, or double-click on the VSC + DDS Help icon in the Extron Electronics group or folder.

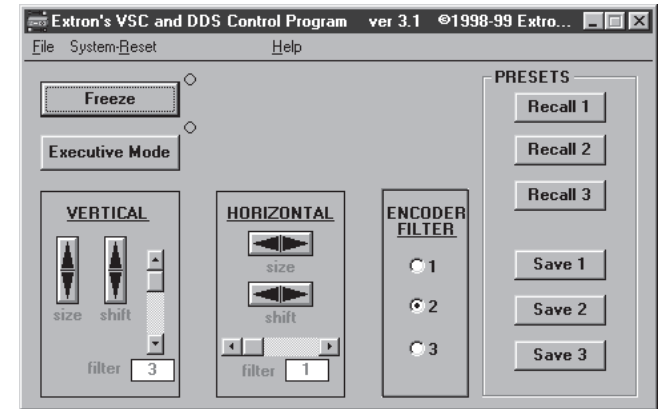

VSC and DDS Control Program window

IR Remote Control

The IR 601 infrared remote control can perform all the functions that are available via the front panel controls except the genlock adjustments.

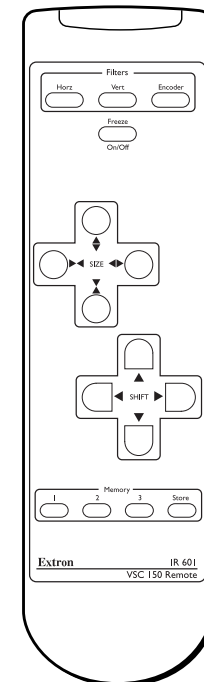

The IR 601 remote

The IR 601 remote control can freeze the image, set filtering adjustments, zoom in and out, resize and shift the image. The push-buttons for these functions on the IR 601 work exactly like those on the VSC 150's front panel. To function properly, the line of sight between the IR controller and the VSC 150 must be unobstructed.

NOTE The Power/signal lock LED blinks while the VSC 150 receives commands from the IR 601.

NOTE If the VSC 150 is set for Executive mode, adjustments can be made via the IR remote control.

NOTE All controls except Freeze will be locked on the IR 601 while Freeze mode is active. Press the Freeze button again to turn off Freeze mode and unlock the other controls.

Using the memory feature

In addition to performing the basic functions, the IR 601 remote control provides a memory storage and recall feature. The VSC 150 offers 30 factory-defined presets and 30 user-defined memory presets that store combinations of size, zoom, panning, centering and filtering settings. These settings are recalled automatically in association with a particular input signal scan rate.

The VSC 150 also offers three additional user-defined presets that can be recalled manually via IR 601 or RS-232 remote control.

The IR 601 has four Memory buttons for storing and recalling up to three presets. To store and recall combinations of settings with the IR 601, follow these steps:

1. Set the sizing/zoom, centering and filtering settings for the desired computer video source by using the front panel controls, RS-232 commands, or the IR 601 controls.
2. Press the Store button in the Memory area of the IR 601 control. The Power/signal lock LED flashes for 4 seconds. During that period, press the button labeled with the number (1, 2 or 3) corresponding to the desired memory. The image settings are stored in a user memory slot corresponding to that number. If the button is pressed after the LED stops flashing, the settings are not stored.
3. To recall a setup that has been stored in memory, press the appropriate numbered Memory button. The combination of zoom, sizing and filtering level settings are recalled.

The same three user-defined presets can also be saved and recalled using the RS-232 control. To store and recall these memory presets via RS-232 control, follow these steps:

1. Set the sizing/zoom, centering and filtering settings for the desired computer video source by using the front panel controls, RS-232 commands, or the IR 601 controls.
2. Use the memory commands in the Command/response table on page 3-5 to save or recall the presets.



VSC 150

Appendix

Specifications

Accessories and Part Numbers

Specifications

Included Parts

Accessories

Specifications

Video input

Number/signal type	1 VGA, 1 Mac analog RGBHV, RGBS, RGB
Connectors	VGA 15-pin HD female Mac 15-pin D female
Minimum/maximum level(s)....	Analog 0V to 2.0V p-p with no offset
Impedance	75 ohms or High Z (DIP switch-selectable)
Horizontal frequency	Autoscan 24 kHz to 71 kHz
Vertical frequency	Autoscan 50 Hz to 120 Hz
Resolution range	Autoscan 560 x 384 to 1280 x 1024 Note: 1280 x 1024 is available at 60 Hz only.
External sync (genlock)	0.3V to 1.0V p-p

NOTE The color subcarrier adjustment range is $\pm 90^\circ$ from 0° for a total adjustment range of 180° .

Video processing

Encoder	10 bit digital
Digital sampling	24 bit, 8 bits per color; 50 MHz standard
Colors	16.8 million
Horizontal filtering	2 levels (selectable)
Vertical filtering	3 levels (selectable)
Encoder filtering	3 levels (selectable)

Video output

Number/signal type	1 RGBHV/RGBS 15.75 kHz analog, or 1 component video, or 1 S-video NTSC, 15.75 kHz, 525 lines, or PAL, 15.5 kHz, 625 lines 1 composite video NTSC, 15.75 kHz, 525 lines, or PAL, 15.5 kHz, 625 lines
Connectors	RGBHV/RGBS 6 BNC female S-video 1 4-pin mini-DIN female Component video (YUV) 3 BNC female (uses the R, G, and B BNCs) Composite video 1 BNC female
Nominal level	RGBHV/RGBS, component .. 0.7V p-p S-video, composite video 1.0V p-p
Impedance	75 ohms

Sync

Input type	Autodetect RGBHV, RGBS, RGB
Output type	RGBHV, RGBS
Genlock connectors	2 BNC female
Standards	NTSC 3.58, PAL
Input level	1.5V to 5.0V p-p
Output level	TTL 5.0V p-p
Input impedance	75 ohms
Output impedance	75 ohms
Polarity	Negative

Control/remote — scan converter

Serial control port	RS-232, 9-pin female D connector
Baud rate and protocol	9600, 8-bit, 1 stop bit, no parity
Serial control pin configurations .	2 = TX, 3 = RX, 5 = GND
IR controller module	Extron's IR 601
Program control	Extron's control program for Windows® Extron's Simple Instruction Set™ – SIS™

General

Power	100VAC to 240VAC, 50/60 Hz, 40 watts, internal, auto-switchable
Temperature/humidity	Storage -40° to $+158^\circ\text{F}$ (-40° to $+70^\circ\text{C}$) / 10% to 90%, non-condensing Operating $+32^\circ$ to $+122^\circ\text{F}$ (0° to $+50^\circ\text{C}$) / 10% to 90%, non-condensing
Rack mount	Yes, with optional rack shelf, part #60-190-01
Enclosure type	Metal
Enclosure dimensions	1.75" H x 8.75" W x 9.50" D 4.45 cm H x 22.23 cm W x 24.13 cm D (Add 0.5" for front panel knobs and 0.75" for rear panel connectors.)
Shipping weight	5 lbs (2.3 kg)
Vibration	ISTA/NSTA 1A in carton (International Safe Transit Association)
Approvals	UL, CUL, CE, FCC Class A
MTBF	30,000 hours
Warranty	2 years parts and labor

NOTE Specifications are subject to change without notice.

Accessories and Part Numbers

Included Parts

These items are included in each order for a VSC 150:

Included parts	Part number
VSC 150	60-312-01
Mac-HV/VGA cable (6 feet)	26-462-01
S-video cable (6 feet)	26-316-02
75 ohm BNC termination adapter	26-300-01
IR 601 remote controller	
VSC 150 User's Manual	68-469-01
VSC/DDS control software for Windows version 3.1 or higher	29-038-01

Accessories

Accessories	Part number
1U rack shelf	60-190-01

Accessories and Part Numbers, cont'd

Free Manuals Download Website

<http://myh66.com>

<http://usermanuals.us>

<http://www.somanuals.com>

<http://www.4manuals.cc>

<http://www.manual-lib.com>

<http://www.404manual.com>

<http://www.luxmanual.com>

<http://aubethermostatmanual.com>

Golf course search by state

<http://golfingnear.com>

Email search by domain

<http://emailbydomain.com>

Auto manuals search

<http://auto.somanuals.com>

TV manuals search

<http://tv.somanuals.com>