

HDMI Extenders

DTP T HWP 231 D

DTP T HWP 331 D

HDMI Twisted Pair Extender Transmitters



Extron Electronics
INTERFACING, SWITCHING AND CONTROL

Safety Instructions

Safety Instructions • English

WARNING: This symbol, ⚠, when used on the product, is intended to alert the user of the presence of uninsulated dangerous voltage within the product's enclosure that may present a risk of electric shock.

ATTENTION: This symbol, ⚠, when used on the product, is intended to alert the user of important operating and maintenance (servicing) instructions in the literature provided with the equipment.

For information on safety guidelines, regulatory compliances, EMI/EMF compatibility, accessibility, and related topics, see the Extron Safety and Regulatory Compliance Guide, part number 68-290-01, on the Extron website, www.extron.com.

Instructions de sécurité • Français

AVERTISSEMENT: Ce pictogramme, ⚠, lorsqu'il est utilisé sur le produit, signale à l'utilisateur la présence à l'intérieur du boîtier du produit d'une tension électrique dangereuse susceptible de provoquer un choc électrique.

ATTENTION: Ce pictogramme, ⚠, lorsqu'il est utilisé sur le produit, signale à l'utilisateur des instructions d'utilisation ou de maintenance importantes qui se trouvent dans la documentation fournie avec le matériel.

Pour en savoir plus sur les règles de sécurité, la conformité à la réglementation, la compatibilité EMI/EMF, l'accessibilité, et autres sujets connexes, lisez les informations de sécurité et de conformité Extron, réf. 68-290-01, sur le site Extron, www.extron.com.

Sicherheitsanweisungen • Deutsch

WARNUNG: Dieses Symbol ⚠ auf dem Produkt soll den Benutzer darauf aufmerksam machen, dass im Inneren des Gehäuses dieses Produktes gefährliche Spannungen herrschen, die nicht isoliert sind und die einen elektrischen Schlag verursachen können.

VORSICHT: Dieses Symbol ⚠ auf dem Produkt soll dem Benutzer in der im Lieferumfang enthaltenen Dokumentation besonders wichtige Hinweise zur Bedienung und Wartung (Instandhaltung) geben.

Weitere Informationen über die Sicherheitsrichtlinien, Produkthandhabung, EMI/EMF-Kompatibilität, Zugänglichkeit und verwandte Themen finden Sie in den Extron-Richtlinien für Sicherheit und Handhabung (Artikelnummer 68-290-01) auf der Extron-Website, www.extron.com.

Instrucciones de seguridad • Español

ADVERTENCIA: Este símbolo, ⚠, cuando se utiliza en el producto, avisa al usuario de la presencia de voltaje peligroso sin aislar dentro del producto, lo que puede representar un riesgo de descarga eléctrica.

ATENCIÓN: Este símbolo, ⚠, cuando se utiliza en el producto, avisa al usuario de la presencia de importantes instrucciones de uso y mantenimiento recogidas en la documentación proporcionada con el equipo.

Para obtener información sobre directrices de seguridad, cumplimiento de normativas, compatibilidad electromagnética, accesibilidad y temas relacionados, consulte la Guía de cumplimiento de normativas y seguridad de Extron, referencia 68-290-01, en el sitio Web de Extron, www.extron.com.

Инструкция по технике безопасности • Русский

ПРЕДУПРЕЖДЕНИЕ: Данный символ, ⚠, если указан на продукте, предупреждает пользователя о наличии неизолированного опасного напряжения внутри корпуса продукта, которое может привести к поражению электрическим током.

ВНИМАНИЕ: Данный символ, ⚠, если указан на продукте, предупреждает пользователя о наличии важных инструкций по эксплуатации и обслуживанию в руководстве, прилагаемом к данному оборудованию.

Для получения информации о правилах техники безопасности, соблюдении нормативных требований, электромагнитной совместимости (ЭМП/ЭДС), возможности доступа и других вопросах см. руководство по безопасности и соблюдению нормативных требований Extron на сайте Extron: www.extron.com, номер по каталогу - 68-290-01.

Chinese Simplified (简体中文)

警告: ⚠ 产品上的这个标志意在警告用户该产品机壳内有暴露的危险电压,有触电危险。

注意: ⚠ 产品上的这个标志意在提示用户设备随附的用户手册中有重要的操作和维护(维修)说明。

关于我们产品的安全指南、遵循的规范、EMI/EMF 的兼容性、无障碍使用的特性等相关内容, 敬请访问 Extron 网站 www.extron.com, 参见 Extron 安全规范指南, 产品编号 68-290-01。

Chinese Traditional (繁體中文)

警告: ⚠ 若產品上使用此符號, 是為了提醒使用者, 產品機殼內存在著可能會導致觸電之風險的未絕緣危險電壓。

注意: ⚠ 若產品上使用此符號, 是為了提醒使用者。

有關安全性指導方針、法規遵守、EMI/EMF 相容性、存取範圍和相關主題的詳細資訊, 請瀏覽 Extron 網站: www.extron.com, 然後參閱《Extron 安全性與法規遵守手冊》, 準則編號 68-290-01。

Japanese

警告: この記号 ⚠ が製品上に表示されている場合は、筐体内に絶縁されていない高電圧が流れ、感電の危険があることを示しています。

注意: この記号 ⚠ が製品上に表示されている場合は、本機の取扱説明書に記載されている重要な操作と保守(整備)の指示についてユーザーの注意を喚起するものです。

安全上のご注意、法規遵守、EMI/EMF適合性、その他の関連項目については、エクストロンのウェブサイト www.extron.com より『Extron Safety and Regulatory Compliance Guide』(P/N 68-290-01) をご覧ください。

Korean

경고: 이 기호 ⚠ 가 제품에 사용될 경우, 제품의 인클로저 내에 있는 접지되지 않은 위험한 전류로 인해 사용자가 감전될 위험이 있음을 경고합니다.

주의: 이 기호 ⚠ 가 제품에 사용될 경우, 장비와 함께 제공된 책자에 나와 있는 주요 운영 및 유지보수(정비) 지침을 경고합니다.

안전 가이드라인, 규제 준수, EMI/EMF 호환성, 접근성, 그리고 관련 항목에 대한 자세한 내용은 Extron 웹 사이트(www.extron.com)의 Extron 안전 및 규제 준수 안내서, 68-290-01 조항을 참조하십시오.

FCC Class A Notice

This equipment has been tested and found to comply with the limits for a Class A digital device, pursuant to part 15 of the FCC rules. The Class A limits provide reasonable protection against harmful interference when the equipment is operated in a commercial environment. This equipment generates, uses, and can radiate radio frequency energy and, if not installed and used in accordance with the instruction manual, may cause harmful interference to radio communications. Operation of this equipment in a residential area is likely to cause interference. This interference must be corrected at the expense of the user.

ATTENTION: The Twisted Pair Extension technology works with shielded twisted pair (STP) cables **only**. To ensure FCC Class A and CE compliance, STP cables and STP connectors are also required.

For more information on safety guidelines, regulatory compliances, EMI/EMF compatibility, accessibility, and related topics, see the “[Extron Safety and Regulatory Compliance Guide](#)” on the Extron website.

Conventions Used in this Guide

Notifications

The following notifications are used in this guide:

CAUTION: Risk of minor personal injury.

ATTENTION : Risque de blessure mineure

ATTENTION: Risk of property damage.

ATTENTION : Risque de dommages matériels

NOTE: A note draws attention to important information.

Specifications Availability

Product specifications are available on the Extron website, www.extron.com.

Copyright

© 2014 Extron Electronics. All rights reserved.

Trademarks

All trademarks mentioned in this guide are the properties of their respective owners.

The following registered trademarks^(R), registered service marks^(SM), and trademarks^(TM) are the property of RGB Systems, Inc. or Extron Electronics:

Registered Trademarks ^(R)
AVTrac, Cable Cubby, CrossPoint, eBUS, EDID Manager, EDID Minder, Extron, Flat Field, GlobalViewer, Hideaway, Inline, IP Intercom, IP Link, Key Minder, LockIt, MediaLink, PlenumVault, PoleVault, PowerCage, PURE3, Quantum, SoundField, SpeedMount, SpeedSwitch, System INTEGRATOR, TeamWork, TouchLink, V-Lock, VersaTools, VN-Matrix, VoiceLift, WallVault, WindoWall, XTP and XTP Systems
Registered Service Mark^(SM) : S3 Service Support Solutions
Trademarks ^(TM)
AAP, AFL (Accu-Rate Frame Lock), ADSP (Advanced Digital Sync Processing), Auto-Image, CableCover, CDRS (Class D Ripple Suppression), DDSP (Digital Display Sync Processing), DMI (Dynamic Motion Interpolation), Driver Configurator, DSP Configurator, DSVP (Digital Sync Validation Processing), EQIB, FastBite, FOXBOX, Global Configurator, IP Intercom HelpDesk, LinkLicense, MAAP, MicroDigital, ProDSP, QS-FPC (QuickSwitch Front Panel Controller), Scope-Trigger, SIS, Simple Instruction Set, Skew-Free, SpeedNav, Triple-Action Switching, XTRA, ZipCaddy, ZipClip

Contents

Introduction..... 1

About this Guide.....	1
About the DTP T HWP 231 and 331 D Extenders	1
Twisted Pair Cable Advantages.....	2
Transmission Distance	2
Features	3

Installation and Operation..... 4

Mounting the Transmitter or Receiver.....	4
UL and Safety Guidelines.....	4
Site Preparation and Wall Box Installation	4
Mud Ring Installation	6
Final Installation	7
Transmitter Front Panel.....	7
Transmitter Rear Panel.....	8
TP Cable Termination and Recommendations	10
Power Supply Wiring	11
RS-232 and IR Connector Wiring	13
Operation	14
Transmitter Power Indicator	14
System Operation.....	14

Reference Information 15

Decora Template Dimensions	15
----------------------------------	----

Introduction

- [About this Guide](#)
- [About the DTP T HWP 231 D and 331 D Extenders](#)
- [Features](#)

About this Guide

This guide describes how to install, operate, and configure the Extron DTP T HWP 231 D and DTP T HWP 331 D models of High-Definition Multimedia Interface (HDMI™) Extenders.

About the DTP T HWP 231 D and 331 D Extenders

The Extron DTP T HWP 231 D and 331 D extenders are HDMI transmitters (see figure 1) which are housed in enclosures that can be mounted in Underwriters Laboratories (UL) standard wall boxes with Decora®-style face plates. A transmitter paired with a compatible receiver extends the usable distance of HDMI digital video and RS-232 or IR control signals over one shielded twisted pair (STP) cable.

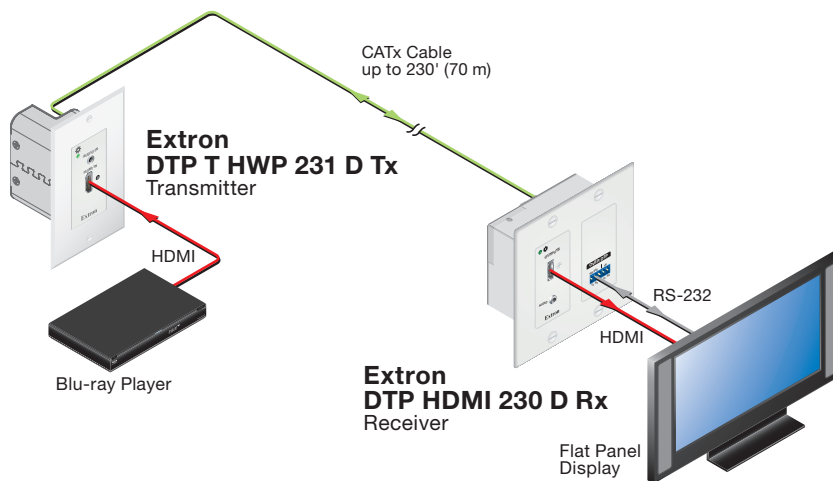

Figure 1. A Typical DTP T HWP 231/331 D Point-to-Point Application

A DTP T HWP 231 D and 331 D system consists of a transmitter (Tx) and a compatible receiver (Rx). A typical system can handle a single HDMI digital video signal and a bidirectional RS-232 or IR link. Each purchased transmitter is shipped with a single external desktop 12 VDC power supply that accepts 100 to 240 VAC, 50-60 Hz input. A single power supply connected to either the transmitter or a compatible receiver can power both units through the twisted pair cable that links the units (see [Power Supply Wiring](#) on page 11 for more information).

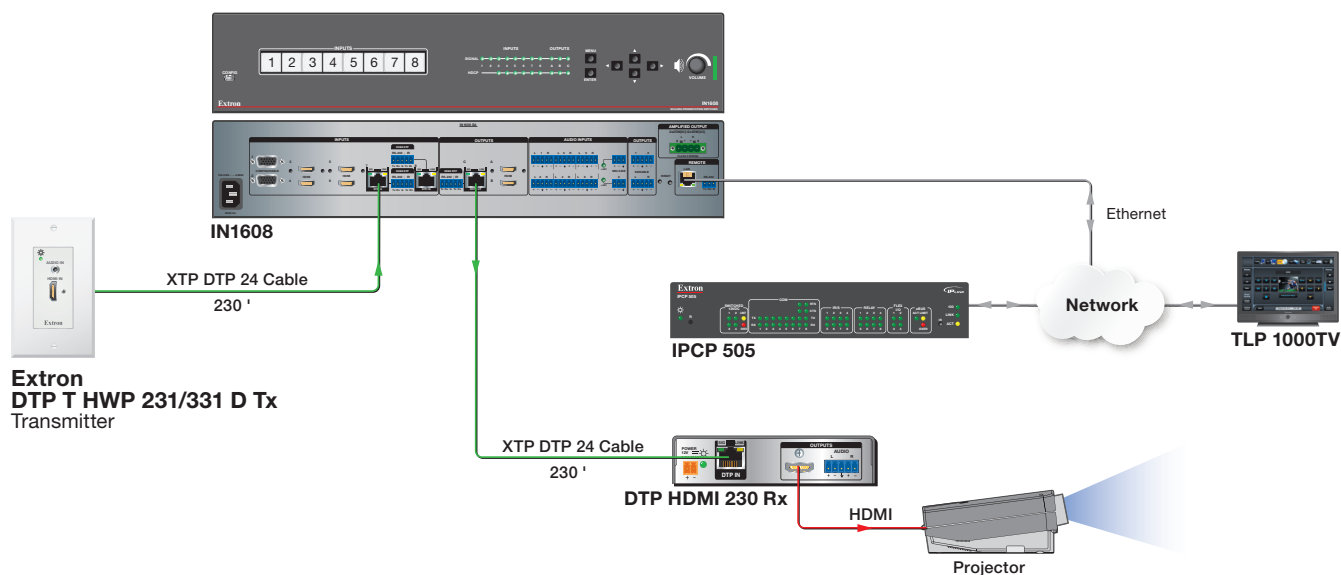

Figure 2. A Typical DTP T HWP 231/331 D Application in a Larger System

Twisted Pair Cable Advantages

Twisted pair (TP) cable is much smaller, lighter, more flexible, and less expensive than coaxial or HDMI cable. These transmitter TP products make cable runs simpler and less cumbersome. Termination of the cable with RJ-45 connectors is simple, quick, and economical (see [TP Cable Termination and Recommendations](#) on page 10 for more information).

NOTE: Do **not** use Extron UTP23SF-4 Enhanced Skew-Free AV UTP cable or STP201 cable to link the transmitter and receiver. The DTP T HWP 231 D and 331 D products do not work properly with these cables.

Control communications

The RS-232 or infrared (IR) communications are pass-through only. The transmitters do not generate or respond to these signals.

Transmission Distance

The maximum transmission distance is determined by the resolution of the signal and the twisted pair cable, graphics card, and display used in the system.

- **The DTP T HWP 231 D** transmitters and compatible receivers can transmit and receive video signals of 720p, 1080i, and 1080p HDTV up to 230 feet (70 meters), and UHD (3840x2160) @ 30 Hz or 4k (4096x2160) @ 30 Hz up to 130 feet (40 meters).
- **The DTP T HWP 331 D** transmitters and compatible receivers can transmit and receive video signals of 720p, 1080i, 1080p HDTV, UHD (3840x2160) @ 30 Hz, or 4k (4096x2160) @ 30 Hz up to 330 feet (100 meters).

Features

Transmits single link HDMI-D signals over one STP cable — Twisted pair cables provide an economical, easily installed cable solution.

Supports DDC and HDCP transmission — The DTP T HWP 231 D and 331 D transmitters fully support long distance transmission of the DDC and HDCP signals.

Control communications pass-through — Bidirectional RS-232 or IR control signals can be transmitted alongside the HDMI signal, so that the remote display can be controlled without the need for additional cabling.

Audio routing — The DTP T HWP 231 D and 331 D transmitters also route unbalanced stereo audio.

Supports CEC signal transmission

Wall-mountable enclosures

External 100 VAC to 240 VAC, 50-60 Hz, international power supply — Included with transmitters.

Remote powering of the transmitter — Only one power supply is necessary to power a transmitter or compatible receiver.

Supports computer video up to 1920x1200, HDTV 1080p @ 60 Hz with Deep Color, UHD, and 4k resolutions.

Installation and Operation

This section describes the installation and the operation of the DTP T HWP 231 D and 331 D, including:

- **Mounting the Transmitter**
- **Transmitter Front Panel**
- **Transmitter Rear Panel**
- **TP Cable Termination and Recommendations**
- **Power Supply Wiring**
- **RS-232 and IR Connector Wiring**
- **Operation**

Mounting the Transmitter

ATTENTION: Installation and service must be performed by authorized personnel.

ATTENTION : L'installation et l'entretien doivent être effectués par le personnel autorisé uniquement.

The DTP T HWP 231 D and 331 D transmitters can be installed in a one-gang electrical wall box, or with a mud ring, with a Decora wall plate cover (supplied).

The installation must conform to national and local building, electrical, and safety codes and to the size requirements of the wall plate.

UL and Safety Guidelines

The following UL guidelines pertain to the installation of the Decora transmitters into a wall or furniture.

- These units are not to be connected to a centralized DC power source or used beyond their rated voltage range.
- These units must be installed in UL-Listed wall boxes.
- These units must be installed with conduit in accordance with National Electrical Code.

Site Preparation and Wall Box Installation

Choose a location that allows cable runs without interference. Allow enough depth for both the wall box and the cables. Install the cables into the wall, furniture, or conduits before installing the wall plate.

NOTE: The Decora units are very deep and have connectors on the back side. Extron recommends a 1-gang wall box which has a depth of at least 3.0 inches (7.6 cm) to accommodate the connectors and cables.

To install a new wall box, perform steps 1 through 9. If a suitable wall box is already installed, perform steps 6 through 9, starting on the next page. UL-listed wall boxes are recommended.

1. If a wall box is not available to use for a template, use the **Decora Template Dimensions** on page 15 to create a template. If installing directly into furniture, cut out the center portion of the template.
2. Place the wall box (or the full-sized template) against the installation surface, and mark the opening guidelines.
3. Cut out the material from the marked area.
4. Insert the wall box into the opening. The rear connectors on the box or wall plate should fit easily into the opening. Enlarge or smooth the edges of the opening if needed.
5. Secure the wall box with nails or screws, leaving the front edge flush with the outer wall or furniture surface (see figure 3).

NOTES:

- If attaching the wall box to wood, use four #8 or #10 screws or 10-penny nails. A minimum of 0.5 inch (1.3 cm) of screw thread must penetrate the wood.
- If attaching the wall box to metal studs or furniture, use four #8 or #10 self-tapping sheet metal screws or machine bolts with matching nuts.

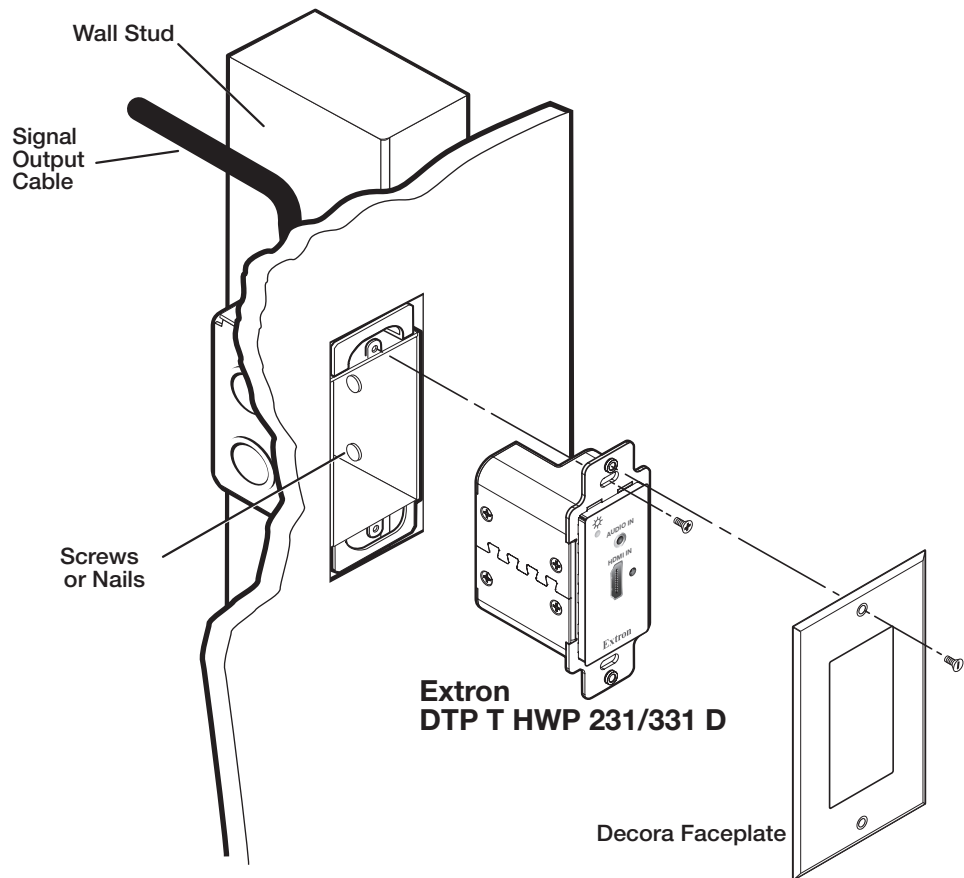

Figure 3. Installing the Wall Box and Mounting the Unit

6. Feed the twisted pair cables and, if applicable, the power cables through the opening and through the wall box punch-out holes, securing them with cable clamps to provide strain relief.

NOTES:

- In order to fit in the wall box, the twisted pair cables and RJ-45 connectors should not have a boot installed.
- One power supply can power both the transmitter and compatible receiver, so only one unit needs a power supply (see [Power Supply Wiring](#) on page 11).

7. Trim back and insulate exposed cable shields with heat shrink to reduce the chance of short circuits.

To prevent short circuits, the outer foil shield can be cut back to the point where the cable exits the cable clamp.

8. Connect the cables to the rear of the unit.
9. Connect front panel devices (see [Transmitter Front Panel](#) on the next page for connector details), restore the power supply, and test the transmitter and receiver system. Make any cabling adjustments before final installation, as the cables will be inaccessible afterwards.

Mud Ring Installation

1. Using the mud ring as a guide, mark the edges and cut out the material within the marked area.
2. Insert the mud ring into the opening and rotate and secure the locking arms with the supplied screws shown in figure 4.
3. Follow steps 6 through 9 of Site Preparation and Wall Box Installation above, and Final Installation on the next page.

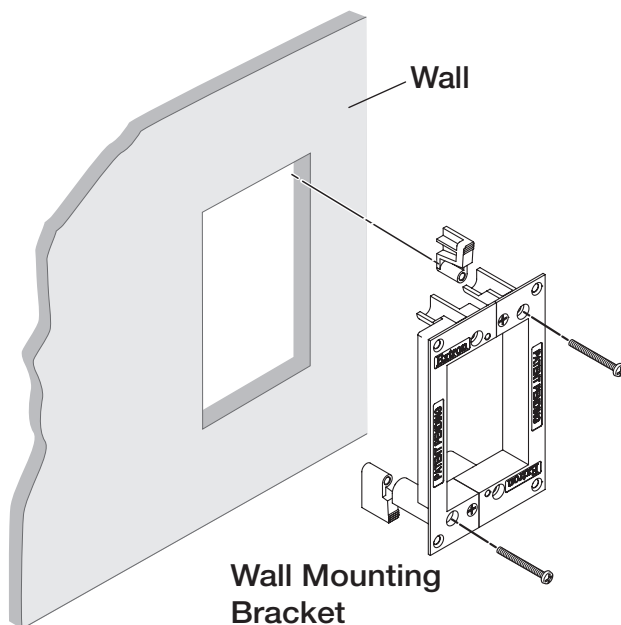

Figure 4. Installing the Mud Ring

Final Installation

After testing and making any adjustments, do the following:

1. At the power outlet, unplug the power supply.

NOTE: One power supply can power both the transmitter and compatible receiver (see **Power Supply Wiring** on page 11).

2. Mount the transmitter into the wall box or mud ring, and attach the supplied Decora faceplate to the unit (see **figure 3** on page 5).
3. At the power outlet, reconnect the power supply. This powers up both units.

Transmitter Front Panel

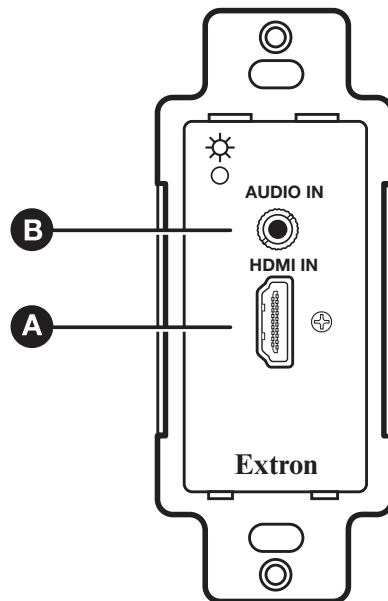

Figure 5. DTP T HWP 231 D and 331 D Transmitter Front Panel Connectors

- A HDMI input connector** — Connect an HDMI cable between this port and the HDMI output port of the digital video source.
- B Audio input** — Connect an unbalanced stereo audio source to this 3.5 mm mini stereo jack. Figure 6 shows how to wire the audio plug.

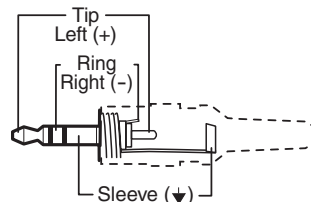

Figure 6. Audio Input Connector Wiring

NOTE: The units do **NOT** embed analog audio onto the HDMI signal. This analog audio signal is transmitted simultaneously with audio embedded within the HDMI signal.

Transmitter Rear Panel

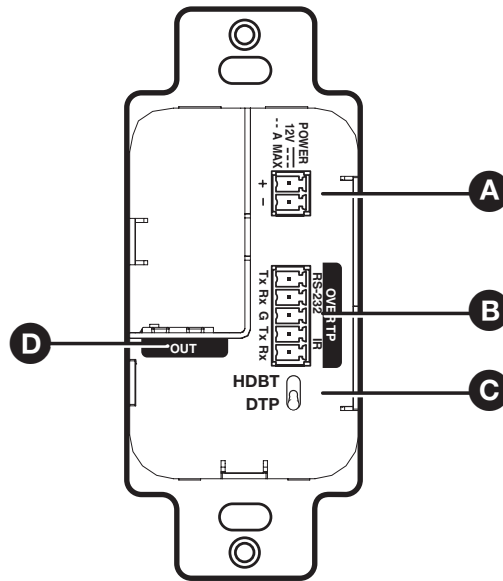

Figure 7. DTP T HWP 231 D and 331 D Transmitter Rear Panel Connectors

- A DC power input connector** — Plug the included external 12 VDC power supply into either this 2-pole connector (see [Power Supply Wiring](#) on page 11 to wire the power connector) or the power input connector on a compatible receiver.
- B Over TP connector** — Connect a serial communications port to this 3.5 mm, 5-pole captive screw connector for bidirectional RS-232 communication and bi-directional IR (see [RS-232 and IR connector wiring](#) on page 13 to wire the connector).
- C HDBaseT/DTP mode switch** — Set this 2-position, recessed switch to configure the output between HDBaseT and DTP modes. When configured for HDBaseT, use an HDBaseT-compatible receiver. When configured for DTP, use a DTP-compatible receiver.

NOTE: When the unit is configured for DTP mode via the rear panel switch, the unit can be powered either locally, with the included external 12 VDC power supply, or over the DTP line by a locally powered receiver or switcher. When configured for HDBaseT mode, remote power capability is disabled, and the unit must be powered locally.

NOTES:

- When the unit is configured for DTP mode via the rear panel switch, the unit can be powered either locally, with the included external 12 VDC power supply, or over the DTP line by a locally powered receiver or switcher. When configured for HDBaseT mode, remote power capability is disabled, and the unit must be powered locally.
- When configured for DTP mode, HDMI video, digital embedded audio, RS-232, IR, analog audio, and remote power are available when used with a DTP-compatible receiving device.
- When configured for HDBaseT mode, HDMI video, digital embedded audio, RS-232, and IR are available when used with an HDBaseT-compatible receiving device.

- D Transmitter output port** — Connect one end of the twisted pair cable to the RJ-45 connector on the transmitter (see **TP Cable Terminations and Recommendations** on page 10 to properly wire the RJ-45 connectors).

ATTENTION:

- Do not connect this device to a telecommunications or computer data network.
- Ne connectez pas ces appareils à des données informatiques ou à un réseau de télécommunications.

TP Cable Termination and Recommendations

Figure 7 details the recommended termination of both ends of TP cables with RJ-45 connectors in accordance with the **TIA/EIA-T568B** wiring standard.

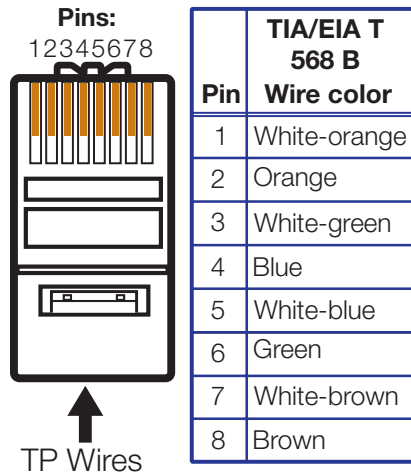

Figure 8. TP Cable Termination

NOTE: Do **not** use Extron UTP23SF-4 Enhanced Skew-Free AV UTP cable or STP201 cable to link the transmitter and receiver. The DTP T HWP 231 D and 331 D products do not work properly with these cables.

Supported cables —

The DTP T HWP 231 D and 331 D transmitters are compatible with shielded twisted pair (F/UTP, SF/UTP, and S/FTP) cable.

Cable recommendations —

Extron recommends using the following practices to reduce transmission errors and achieve full transmission distances up to 230 feet (70 meters) for the 231 models and 330 feet (100 meters) for the 331 models.

- Use the following Extron XTP DTP 24 SF/UTP cables and DTP 24 connectors for the best performance:
 - **XTP DTP 24/1000** Non-Plenum 1000' (305 m) spool 22-236-03
 - **XTP DTP 24P/1000** Plenum 1000' (305 m) spool 22-235-03
 - **XTP DTP 24 Plug** Package of 10 101-005-02
- If not using XTP DTP 24 cable, at a minimum, Extron recommends 24 AWG, solid conductor, STP cable with a minimum bandwidth of 400 MHz.
- Terminate cables with shielded connectors to the TIA/EIA-T568B standard.
- Use no more than two pass-through points, which may include patch points, punch down connectors, couplers, and power injectors. If these pass-through points are required, use CAT 6 or 6a shielded couplers and punch down connectors.

NOTE: When using STP cable in bundles or conduits, consider the following:

- Do not exceed 40% fill capacity in conduits.
- Do not comb the cable for the first 20 meters, where cables are straightened, aligned, and secured in tight bundles.
- Loosely place cables and limit the use of tie wraps or Velcro®.
- Separate twisted pair cables from AC power cables.

Power Supply Wiring

NOTES:

- Only one power supply is required. A single power supply connected to either unit in the pair powers both units.
- A power supply is included with each individually-packaged transmitter.
- Do not tin the power supply leads before installing them in the direct insertion connector. Tinned wires are not as secure in the connectors and could be pulled out.

Figure 9 shows how to wire the connector. Snap the provided ferrite bead onto the DC power cable, between the power supply and the connector on the HDMI unit.

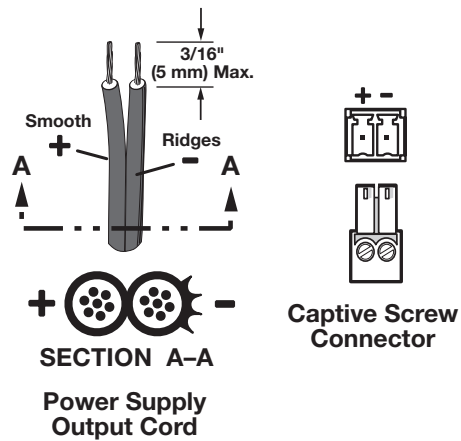

Figure 9. Power Connector Wiring

CAUTION: The two power cord wires must be kept separate while the power supply is plugged in. Remove power before wiring.

ATTENTION : Les deux cordons d'alimentation doivent être tenus à l'écart l'un de l'autre quand l'alimentation est branchée. Couper l'alimentation avant de faire l'installation électrique.

ATTENTION:

- Always use a power supply supplied and or specified by Extron. Use of an unauthorized power supply voids all regulatory compliance certification and may cause damage to the supply and the end product.
 - Utilisez toujours une source d'alimentation fournie ou recommandée par Extron. L'utilisation d'une source d'alimentation non autorisée annule toute conformité réglementaire et peut endommager la source d'alimentation ainsi que le produit final.
- Unless otherwise stated, the AC/DC adapters are not suitable for use in air handling spaces or in wall cavities.
 - Ces sources d'alimentation ne sont pas appropriées pour une utilisation dans les espaces d'aération ou dans les cavités murales.
- The installation must always be in accordance with the applicable provisions of National Electrical Code ANSI/NFPA 70, article 725 and the Canadian Electrical Code part 1, section 16. The power supply shall not be permanently fixed to building structure or similar structure.
 - Cette installation doit toujours être en accord avec les mesures qui s'applique au National Electrical Code ANSI/NFPA 70, article 725, et au Canadian Electrical Code, partie 1, section 16. La source d'alimentation ne devra pas être fixée de façon permanente à une structure de bâtiment ou à une structure similaire.
- Power supply voltage polarity is critical. Incorrect voltage polarity can damage the power supply and the unit. The ridges on the side of the cord (see figure 9) identify the power cord negative lead.
 - La polarité de la source d'alimentation est primordiale. Une polarité incorrecte pourrait endommager la source d'alimentation et l'unité. Les stries sur le côté du cordon permettent de repérer le pôle négatif du cordon d'alimentation.
- To verify the polarity before connection, plug in the power supply with no load and check the output with a voltmeter.
 - Pour vérifier la polarité avant la connexion, brancher l'alimentation hors charge et mesurer sa sortie avec un voltmètre.
- The length of the exposed (stripped) copper wires is important. **The ideal length is 3/16 inch (5 mm).** Longer bare wires can short together. Shorter wires are not as secure in the connectors and could be pulled out.
 - La longueur des câbles exposés est primordiale lorsque l'on entreprend de les dénuder. **La longueur idéale est de 5 mm (3/16 inches).** S'ils sont un peu plus longs, les câbles exposés pourraient se toucher et provoquer un court circuit. S'ils sont un peu plus courts, ils pourraient sortir, même s'ils sont attachés par les vis captives.
- Unless otherwise stated, the AC/DC adapters are not suitable for use in air handling spaces or in wall cavities.
 - Sauf mention contraire, les adaptateurs AC/DC ne sont pas appropriés pour une utilisation dans les espaces d'aération ou dans les cavités murales.

RS-232 and IR Connector Wiring

Figure 10 shows how to wire the RS-232 and IR connector for the DTP T HWP 231 D and 331 D units.

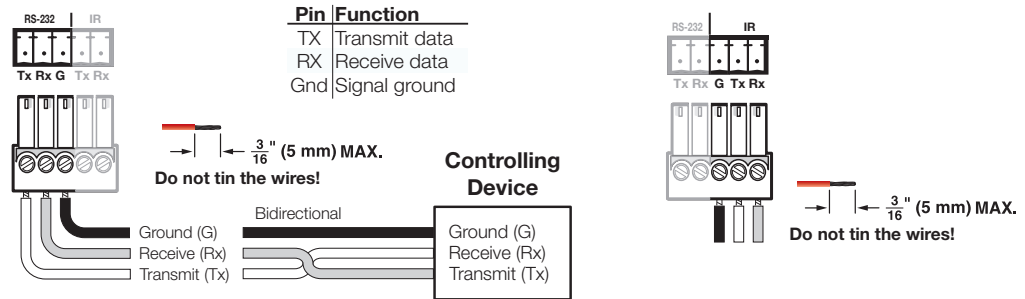

Figure 10. RS-232 and IR Connector Wiring

ATTENTION:

- The length of the exposed (stripped) copper wires is important. The ideal length is 3/16 inch (5 mm). Longer bare wires can short together. Shorter wires are not as secure in the connectors and could be pulled out.
- La longueur des câbles exposés est primordiale lorsque l'on entreprend de les dénuder. La longueur idéale est de 5 mm (3/16 inches). S'ils sont un peu plus longs, les câbles exposés pourraient se toucher et provoquer un court circuit. S'ils sont un peu plus courts, ils pourraient sortir, même s'ils sont attachés par les vis captives.

NOTE: Do not tin the power supply leads before installing them in the direct insertion connector. Tinned wires are not as secure in the connectors and could be pulled out.

Operation

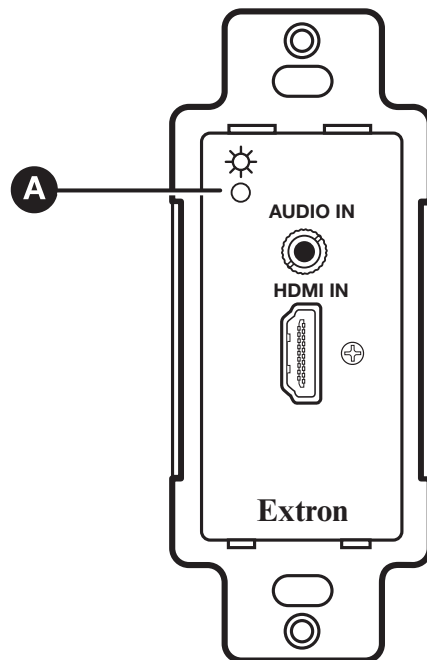

Figure 11. DTP T HWP 231 D and 331 D Transmitter Power Indicator

Transmitter Power Indicator

A Power LED — This two-color front panel LED lights to indicate signal and power status as follows:

- **Amber** — The unit is receiving power but no signal on the HDMI input.
- **Green** — The unit is receiving power and a signal is present on the HDMI input.

System Operation

After the transmitter, compatible receiver, and their connected devices are powered up, the system is fully operational. If any problems are encountered, ensure that all cables are routed and connected properly.

NOTE: Ensure that the video source and display are properly connected to the system, and that the transmitter, compatible receiver, and the display have power applied before power is applied to the video source. If all other devices are not turned on before the video source, the image may not appear.

Reference Information

This section includes decora template dimensions for installation of the DTP T HWP 231 D and DTP T HWP 331 D transmitters.

Decora Template Dimensions

To create a template, use the dimensions shown on figure 12.

NOTES:

- The drawing is not full size or to scale. **DO NOT** scale up or print to use as a template.
- Full size templates are available online at www.extron.com.

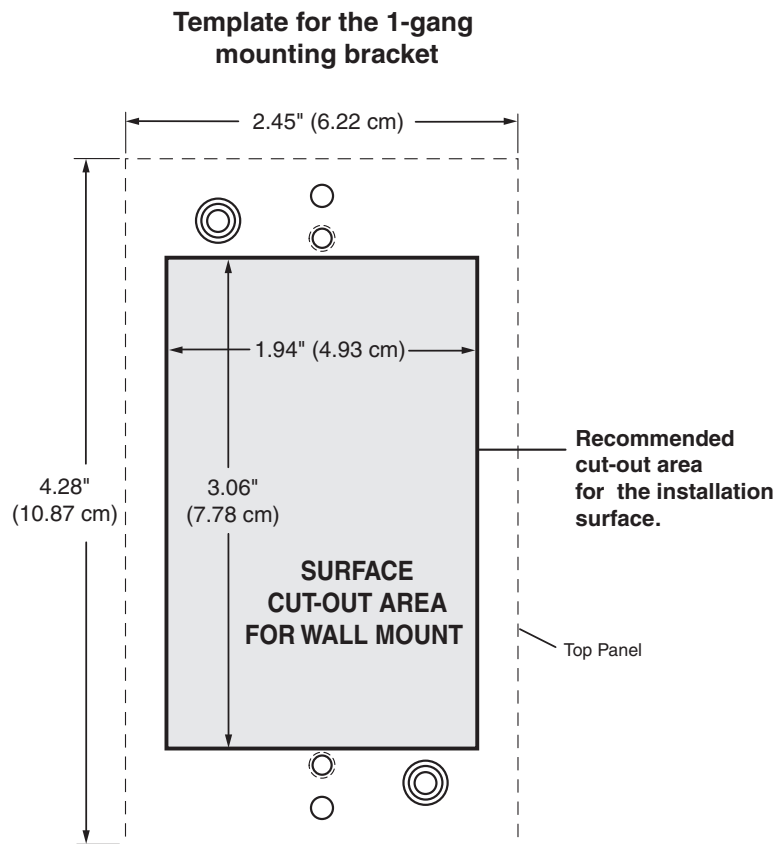

Figure 12. Decora Template Dimensions

Extron Warranty

Extron Electronics warrants this product against defects in materials and workmanship for a period of three years from the date of purchase. In the event of malfunction during the warranty period attributable directly to faulty workmanship and/or materials, Extron Electronics will, at its option, repair or replace said products or components, to whatever extent it shall deem necessary to restore said product to proper operating condition, provided that it is returned within the warranty period, with proof of purchase and description of malfunction to:

USA, Canada, South America, and Central America:

Extron Electronics
1231 South Lewis Street
Anaheim, CA 92805
U.S.A.

Japan:

Extron Electronics, Japan
Kyodo Building, 16 Ichibancho
Chiyoda-ku, Tokyo 102-0082
Japan

Europe and Africa:

Extron Europe
Hanzeboulevard 10
3825 PH Amersfoort
The Netherlands

China:

Extron China
686 Ronghua Road
Songjiang District
Shanghai 201611
China

Asia:

Extron Asia Pte Ltd
135 Joo Seng Road, #04-01
PM Industrial Bldg.
Singapore 368363
Singapore

Middle East:

Extron Middle East
Dubai Airport Free Zone
F12, PO Box 293666
United Arab Emirates, Dubai

This Limited Warranty does not apply if the fault has been caused by misuse, improper handling care, electrical or mechanical abuse, abnormal operating conditions, or if modifications were made to the product that were not authorized by Extron.

NOTE: If a product is defective, please call Extron and ask for an Application Engineer to receive an RA (Return Authorization) number. This will begin the repair process.

USA: 714.491.1500 or 800.633.9876
Asia: 65.6383.4400

Europe: 31.33.453.4040
Japan: 81.3.3511.7655

Units must be returned insured, with shipping charges prepaid. If not insured, you assume the risk of loss or damage during shipment. Returned units must include the serial number and a description of the problem, as well as the name of the person to contact in case there are any questions.

Extron Electronics makes no further warranties either expressed or implied with respect to the product and its quality, performance, merchantability, or fitness for any particular use. In no event will Extron Electronics be liable for direct, indirect, or consequential damages resulting from any defect in this product even if Extron Electronics has been advised of such damage.

Please note that laws vary from state to state and country to country, and that some provisions of this warranty may not apply to you.

Extron Headquarters +1.800.633.9876 (Inside USA/Canada Only) Extron USA - West +1.714.491.1500 +1.714.491.1517 FAX	Extron Europe +800.3987.6673 (Inside Europe Only) +31.33.453.4040 +31.33.453.4050 FAX	Extron Asia +65.6383.4400 +65.6383.4664 FAX	Extron Japan +81.3.3511.7655 +81.3.3511.7656 FAX	Extron China +86.21.3760.1568 +86.21.3760.1566 FAX	Extron Middle East +971.4.299.1800 +971.4.299.1880 FAX	Extron Korea +82.2.3444.1571 +82.2.3444.1575 FAX	Extron India 1.800.3070.3777 (Inside India Only) +91.80.3055.3777 +91.80.3055.3737 FAX
---	--	--	---	---	---	---	---

Free Manuals Download Website

<http://myh66.com>

<http://usermanuals.us>

<http://www.somanuals.com>

<http://www.4manuals.cc>

<http://www.manual-lib.com>

<http://www.404manual.com>

<http://www.luxmanual.com>

<http://aubethermostatmanual.com>

Golf course search by state

<http://golfingnear.com>

Email search by domain

<http://emailbydomain.com>

Auto manuals search

<http://auto.somanuals.com>

TV manuals search

<http://tv.somanuals.com>