

## User's Manual



## VSC 75 Video Scan Converter

68-483-01  
Printed in the USA



**Extron Electronics, USA**  
1230 South Lewis Street, Anaheim, CA 92805  
800.633.9876 714.491.1500 FAX 714.491.1517  
USA

**Extron Electronics, Europe**  
Beeldschermweg 6C, 3821 AH Amersfoort  
+31.33.453.4040 FAX +31.33.453.4050  
The Netherlands

**Extron Electronics, Asia**  
135 Joo Seng Rd. #04-01, PM Industrial Bldg.  
+65.383.4400 FAX +65.383.4664  
Singapore 368363

**Extron Electronics Information**  
ExtronWEB™: [www.extron.com](http://www.extron.com)  
ExtronFAX™: 714.491.0192  
24-hour access—worldwide!

# Precautions

## Safety Instructions • English



This symbol is intended to alert the user of important operating and maintenance (servicing) instructions in the literature provided with the equipment.



This symbol is intended to alert the user of the presence of uninsulated dangerous voltage within the product's enclosure that may present a risk of electric shock.

## Caution

**Read Instructions** • Read and understand all safety and operating instructions before using the equipment.

**Retain Instructions** • The safety instructions should be kept for future reference.

**Follow Warnings** • Follow all warnings and instructions marked on the equipment or in the user information.

**Avoid Attachments** • Do not use tools or attachments that are not recommended by the equipment manufacturer because they may be hazardous.

## Consignes de Sécurité • Français



Ce symbole sert à avertir l'utilisateur que la documentation fournie avec le matériel contient des instructions importantes concernant l'exploitation et la maintenance (réparation).



Ce symbole sert à avertir l'utilisateur de la présence dans le boîtier de l'appareil de tensions dangereuses non isolées posant des risques d'électrocution.

## Attention

**Lire les instructions** • Prendre connaissance de toutes les consignes de sécurité et d'exploitation avant d'utiliser le matériel.

**Conservier les instructions** • Ranger les consignes de sécurité afin de pouvoir les consulter à l'avenir.

**Respecter les avertissements** • Observer tous les avertissements et consignes marqués sur le matériel ou présentés dans la documentation utilisateur.

**Eviter les pièces de fixation** • Ne pas utiliser de pièces de fixation ni d'outils non recommandés par le fabricant du matériel car cela risquerait de poser certains dangers.

## Sicherheitsanleitungen • Deutsch



Dieses Symbol soll den Benutzer auf wichtige Anleitungen zur Bedienung und Wartung (Instandhaltung) in der Dokumentation hinweisen, die im Lieferumfang dieses Gerätes enthalten ist.



Dieses Symbol soll den Benutzer darauf aufmerksam machen, daß im Inneren des Gehäuses dieses Produktes gefährliche Spannungen, die nicht isoliert sind und die einen elektrischen Schock verursachen können, herrschen.

## Achtung

**Lesen der Anleitungen** • Bevor Sie das Gerät zum ersten Mal verwenden, sollten Sie alle Sicherheits- und Bedienungsanleitungen genau durchlesen und verstehen.

**Aufbewahren der Anleitungen** • Die Sicherheitsanleitungen sollten aufbewahrt werden, damit Sie später darauf zurückgreifen können.

**Befolgen der Warnhinweise** • Befolgen Sie alle Warnhinweise und Anleitungen auf dem Gerät oder in der Benutzerdokumentation.

**Keine Zusatzgeräte** • Verwenden Sie keine Werkzeuge oder Zusatzgeräte, die nicht ausdrücklich vom Hersteller empfohlen wurden, da diese eine Gefahrenquelle darstellen können.

## Instrucciones de seguridad • Español



Este símbolo se utiliza para advertir al usuario sobre instrucciones importantes de operación y mantenimiento (o cambio de partes) que se desean destacar en el contenido de la documentación suministrada con los equipos.



Este símbolo se utiliza para advertir al usuario sobre la presencia de elementos con voltaje peligroso sin protección aislante, que puedan encontrarse dentro de la caja o alojamiento del producto, y que puedan representar riesgo de electrocución.

## Precaucion

**Leer las instrucciones** • Leer y analizar todas las instrucciones de operación y seguridad, antes de usar el equipo.

**Conservar las instrucciones** • Conservar las instrucciones de seguridad para futura consulta.

**Obedecer las advertencias** • Todas las advertencias e instrucciones marcadas en el equipo o en la documentación del usuario, deben ser obedecidas.

**Evitar el uso de accesorios** • No usar herramientas o accesorios que no sean específicamente recomendados por el fabricante, ya que podrían implicar riesgos.

## Warning

**Power sources** • This equipment should be operated only from the power source indicated on the product. This equipment is intended to be used with a main power system with a grounded (neutral) conductor. The third (grounding) pin is a safety feature, do not attempt to bypass or disable it.

**Power disconnection** • To remove power from the equipment safely, remove all power cords from the rear of the equipment, or the desktop power module (if detachable), or from the power source receptacle (wall plug).

**Power cord protection** • Power cords should be routed so that they are not likely to be stepped on or pinched by items placed upon or against them.

**Servicing** • Refer all servicing to qualified service personnel. There are no user-serviceable parts inside. To prevent the risk of shock, do not attempt to service this equipment yourself because opening or removing covers may expose you to dangerous voltage or other hazards.

**Slots and openings** • If the equipment has slots or holes in the enclosure, these are provided to prevent overheating of sensitive components inside. These openings must never be blocked by other objects.

**Lithium battery** • There is a danger of explosion if battery is incorrectly replaced. Replace it only with the same or equivalent type recommended by the manufacturer. Dispose of used batteries according to the manufacturer's instructions.

## Avertissement

**Alimentations** • Ne faire fonctionner ce matériel qu'avec la source d'alimentation indiquée sur l'appareil. Ce matériel doit être utilisé avec une alimentation principale comportant un fil de terre (neutre). Le troisième contact (de mise à la terre) constitue un dispositif de sécurité : n'essayez pas de le contourner ni de le désactiver.

**Déconnexion de l'alimentation** • Pour mettre le matériel hors tension sans danger, déconnectez tous les cordons d'alimentation de l'arrière de l'appareil ou du module d'alimentation de bureau (s'il est amovible) ou encore de la prise secteur.

**Protection du cordon d'alimentation** • Acheminer les cordons d'alimentation de manière à ce que personne ne risque de marcher dessus et à ce qu'ils ne soient pas écrasés ou pincés par des objets.

**Réparation-maintenance** • Faire exécuter toutes les interventions de réparation-maintenance par un technicien qualifié. Aucun des éléments internes ne peut être réparé par l'utilisateur. Afin d'éviter tout danger d'électrocution, l'utilisateur ne doit pas essayer de procéder lui-même à des opérations car l'ouverture ou le retrait des couvercles risquent de l'exposer à de hautes tensions et autres dangers.

**Fentes et orifices** • Si le boîtier de l'appareil comporte des fentes ou des orifices, ceux-ci servent à empêcher les composants internes sensibles de surchauffer. Ces ouvertures ne doivent jamais être bloquées par des objets.

**Lithium Batterie** • Il a danger d'explosion s'il y a remplacement incorrect de la batterie. Remplacer uniquement avec une batterie du même type ou d'un type équivalent recommandé par le constructeur. Mettre au reut les batteries usagées conformément aux instructions du fabricant.

## Vorsicht

**Stromquellen** • Dieses Gerät sollte nur über die auf dem Produkt angegebene Stromquelle betrieben werden. Dieses Gerät wurde für eine Verwendung mit einer Hauptstromleitung mit einem geerdeten (neutralen) Leiter konzipiert. Der dritte Stitt oder Kontakt ist für einen Erdschluß, und stellt eine Sicherheitsfunktion dar und sollte nicht umgangen oder außer Betrieb gesetzt werden.

**Stromunterbrechung** • Um das Gerät auf sichere Weise vom Netz zu trennen, sollten Sie alle Netzkabel aus der Rückseite des Gerätes oder aus dem Desktop-Strommodul (falls dies möglich ist) oder aus der Wandsteckdose ziehen.

**Schutz des Netzkabels** • Netzkabel sollten stets so verlegt werden, daß sie nicht im Weg liegen und niemand darauf treten kann oder Objekte darauf- oder unmittelbar dagegengestellt werden können.

**Wartung** • Alle Wartungsmaßnahmen sollten nur von qualifiziertem Servicepersonal durchgeführt werden. Im Inneren des Gerätes sind keine Teile enthalten, die vom Benutzer gewartet werden können. Zur Vermeidung eines elektrischen Schocks versuchen Sie in keinem Fall, dieses Gerät selbst zu warten, da beim Öffnen oder Entfernen der Abdeckungen die Gefahr eines elektrischen Schlags oder andere Gefahren bestehen.

**Schlitze und Öffnungen** • Wenn das Gerät Schlitze oder Löcher im Gehäuse aufweist, dienen diese zur Vermeidung einer Überhitzung der empfindlichen Teile im Inneren. Diese Öffnungen dürfen niemals von anderen Objekten blockiert werden.

**Litium-Batterie** • Explosionsgefahr, falls die Batterie nicht richtig ersetzt wird. Ersetzen Sie nur durch die gleiche oder einen vergleichbaren Batterietyp, der auch vom Hersteller empfohlen wird. Entsorgung der verbrauchten Batterien bitte gemäß den Herstelleranweisungen.

## Advertencia

**Alimentación eléctrica** • Este equipo debe conectarse únicamente a la fuente / tipo de alimentación eléctrica indicada en el mismo. La alimentación eléctrica de este equipo debe provenir de un sistema de distribución general con conductor neutro a tierra. La tercera pata (puesta a tierra) es una medida de seguridad, no puentearia ni eliminarla.

**Desconexión de alimentación eléctrica** • Para desconectar con seguridad la acometida de alimentación eléctrica al equipo, desenchufar todos los cables de alimentación en el panel trasero del equipo, o desenchufar el módulo de alimentación (si fuera independiente), o desenchufar el cable del receptáculo de la pared.

**Protección del cables de alimentación** • Los cables de alimentación eléctrica se deben instalar en lugares donde no sean pisados ni apretados por objetos que se puedan apoyar sobre ellos.

**Reparaciones/mantenimiento** • Solicitar siempre los servicios técnicos de personal calificado. En el interior no hay partes a las que el usuario deba acceder. Para evitar riesgo de electrocución, no intentar personalmente la reparación/ mantenimiento de este equipo, ya que al abrir o extraer las tapas puede quedar expuesto a voltajes peligrosos u otros riesgos.

**Ranuras y aberturas** • Si el equipo posee ranuras o orificios en su caja/alojamiento, es para evitar el sobrecalentamiento de componentes internos sensibles. Estas aberturas nunca se deben obstruir con otros objetos.

**Bateria de litio** • Existe riesgo de explosión si esta batería se coloca en la posición incorrecta. Cambiar esta batería únicamente con el mismo tipo (o su equivalente) recomendado por el fabricante. Desachar las baterías usadas siguiendo las instrucciones del fabricante.

# FCC Class A Notice

Note: This equipment has been tested and found to comply with the limits for a Class A digital device, pursuant to part 15 of the FCC Rules. These limits are designed to provide reasonable protection against harmful interference when the equipment is operated in a commercial environment. This equipment generates, uses and can radiate radio frequency energy and, if not installed and used in accordance with the instruction manual, may cause harmful interference to radio communications. Operation of this equipment in a residential area is likely to cause harmful interference, in which case the user will be required to correct the interference at his own expense.

Note: This unit was tested with shielded cables on the peripheral devices. Shielded cables must be used with the unit to ensure compliance.

# Extron's Warranty

Extron Electronics warrants this product against defects in materials and workmanship for a period of two years from the date of purchase. In the event of malfunction during the warranty period attributable directly to faulty workmanship and/or materials, Extron Electronics will, at its option, repair or replace said products or components, to whatever extent it shall deem necessary to restore said product to proper operating condition, provided that it is returned within the warranty period, with proof of purchase and description of malfunction to:

Extron Electronics  
1230 South Lewis Street  
Anaheim, CA 92805, U.S.A.

This Limited Warranty does not apply if the fault has been caused by misuse, improper handling care, electrical or mechanical abuse, abnormal operating conditions or non-Extron authorized modification to the product.

*If it has been determined that the product is defective, please call Extron and ask for an Applications Engineer at 714.491.1500 to receive an RA# (Return Authorization number). This will begin the repair process as quickly as possible.*

Units must be returned insured, with shipping charges prepaid. If not insured, you assume the risk of loss or damage during shipment. Returned units must include the serial number and a description of the problem, as well as the name of the person to contact in case there are any questions.

Extron Electronics makes no further warranties either expressed or implied with respect to the product and its quality, performance, merchantability, or fitness for any particular use. In no event will Extron Electronics be liable for direct, indirect, or consequential damages resulting from any defect in this product even if Extron Electronics has been advised of such damage.

Please note that laws vary from state to state, and that some provisions of this warranty may not apply to you.

# Table of Contents

---

<b>Chapter 1 • Introduction</b> .....	1-1
<b>About the VSC 75</b> .....	1-2
<b>Features</b> .....	1-2
<b>Chapter 2 • Installation and Operation</b> .....	2-1
<b>Installation Overview</b> .....	2-2
<b>Mounting the VSC 75</b> .....	2-2
Tabletop/desktop placement .....	2-2
Rack mounting .....	2-3
<b>Front Panel Features</b> .....	2-4
<b>Rear Panel Features</b> .....	2-6
<b>Cabling</b> .....	2-7
Mac-HV/VGA cable connector pin assignments .....	2-9
<b>Optimizing the Image</b> .....	2-10
<b>Troubleshooting</b> .....	2-11
If the image does not appear .....	2-11
If the image is not displayed correctly .....	2-12
If the scan converter does not respond to controls .....	2-12
<b>Chapter 3 • Serial Communication</b> .....	3-1
<b>RS-232 Programmer's Guide</b> .....	3-2
VSC-initiated messages .....	3-2
VSC error responses .....	3-3
Time-out .....	3-3
Using the command/response table .....	3-3
Command/response table .....	3-4
<b>Control Software for Windows</b> .....	3-6
Installing the software .....	3-6
Using the software .....	3-6
<b>Appendix • Specifications, Part Numbers, and Accessories</b> .....	A-1
<b>Specifications</b> .....	A-2
<b>Included Parts</b> .....	A-4
<b>Accessories</b> .....	A-4

68-483-01 B  
Printed in the USA  
09 00



# 1 Chapter One

## Introduction

About the VSC 75

Features

## About the VSC 75

Extron's VSC 75 is a high resolution computer-to-video scan converter with all-digital controls. The VSC 75 converts a computer video signal into two display outputs — composite video and S-video — for simultaneous scan-converted output on two separate devices. This allows the video from a computer to be displayed on a television monitor or recorded on a DVD, VCR, video editing bay or other recording device. All of the outputs are NTSC/PAL.

This scan converter accepts one Macintosh or VGA computer input of a resolution up to 1280 x 1024, and provides a local monitor loop-out.

The VSC 75 is 1U high and one half rack wide. It is rack mountable, and has an internal, autoswitching power supply. It can be controlled via front panel controls and RS-232 remote control.

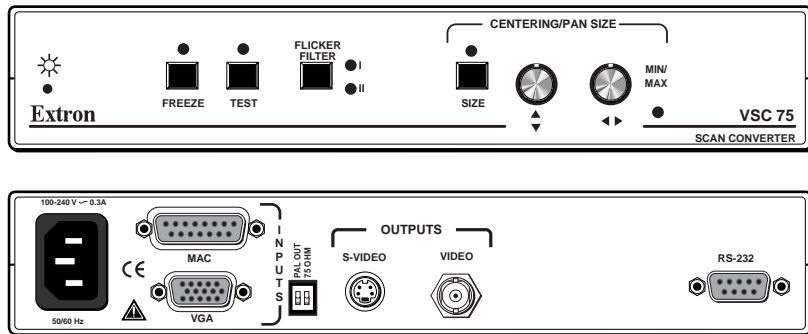

Figure 1 — VSC 75 front and rear panels

## Features

**Picture sizing/zoom controls** — Separate digital rotary controls on the VSC 75 allow horizontal and/or vertical picture resizing to fit the display device or zoom in or out. These settings are stored in user-defined memories.

**Picture centering and panning** — Center the picture horizontally and vertically or pan across the picture with these front panel rotary controls.

**Freeze mode** — This feature provides a still image of the scan-converted picture.

**Flicker filtering control** — The flicker filter level is user-selectable from the front panel for control of flicker reduction.

**Test mode** — This feature causes a color bar test pattern to be displayed on the output devices.

**RS-232 control** — The VSC 75 can be controlled via computer or another control device through an RS-232 connection and Extron's Simple Instruction Set™ (SIS™) or the Extron graphical control program for Windows®.

**Executive mode** — To prevent unauthorized or accidental adjustments to the VSC 75's settings via front panel controls, executive mode locks all the front panel features except centering controls. Adjustments can still be made via RS-232 control when executive mode is active.

**Output formats** — NTSC/PAL composite video output and S-video output are continuously available on rear panel connectors.

**VGA or Macintosh input and local monitor output** — The 15-pin HD and 15-pin D connectors allow easy connection to a PC or Mac local monitor. The included male Mac-VGA cable connects the VSC 75 to the computer without need for additional adapters.

**Rack mountability** — The VSC 75 can be rack mounted on one side of an optional 1U rack shelf (Extron part #60-190-01).



# Chapter Two

## Installation and Operation

Installation Overview

Mounting the VSC 75

Front Panel Features

Rear Panel Features

Cabling

Optimizing the Image

Troubleshooting

## Installation Overview

To install and set up the VSC 75, follow these basic steps:

- 1 Turn all of the equipment off. Make sure that the source computer, the VSC 75, and the output devices (projector, monitors) are turned off and disconnected from the power source.
- 2 Mount the scan converter. See “Mounting the VSC 75” on page 2-2.
- 3 Set the rear panel toggle and DIP switches. See “Rear Panel Features” on page 2-6.
- 4 Attach the cables. See “Cabling” on page 2-7 and “Rear Panel Features” on page 2-6.
- 5 Connect power cords and turn on all the equipment.
- 6 The image should now appear. If not, ensure that all devices are plugged in and receiving power. Check the cabling and rear panel switches, and make adjustments as needed. Refer to “Troubleshooting” on page 2-11 if needed.
- 7 Optimize the image for your display environment. See “Optimizing the Image” on page 2-10.

## Mounting the VSC 75

Select tabletop placement or rack mounting. Follow the appropriate installation instructions on these two pages.

### Tabletop/desktop placement

For tabletop or desktop placement only, install the self-adhesive rubber feet/pads (provided) onto the four corners of the bottom of the enclosure.

### Rack mounting

1. If feet were installed on the bottom of the VSC 75, remove them.
2. Place the VSC 75 on one half of the 1U (one unit high, one unit wide) rack shelf (part #60-190-01). Align the front of the VSC 75 with the front of the shelf, and align the threaded holes on the bottom of the VSC 75 with the holes in the rack shelf.
3. Attach the VSC 75 to the rack shelf with the two provided 4-40 x 1/8” machine screws. Insert the

screws from the underside of the shelf, and securely fasten them into diagonally-opposite corners as shown in figure 2.

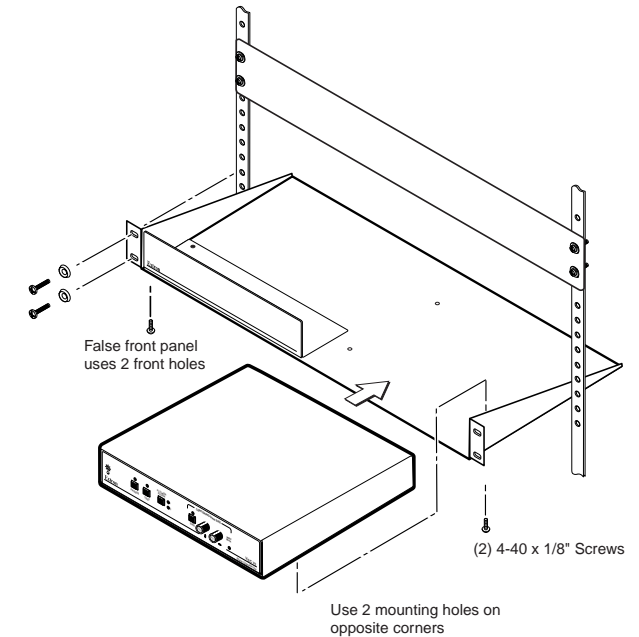

Figure 2 — Rack mounting

4. Attach the false front panel (provided with the rack shelf) to the unoccupied side of the rack (as shown above), or install a second half-rack-width device in that side by repeating steps 1 – 3.
5. Attach the rack shelf to the rack using four 10-32 x 3/4” bolts (provided). Insert the bolts through #10 beveled washers, then through the holes in the rack ears and rack, as shown above.

## Front Panel Features

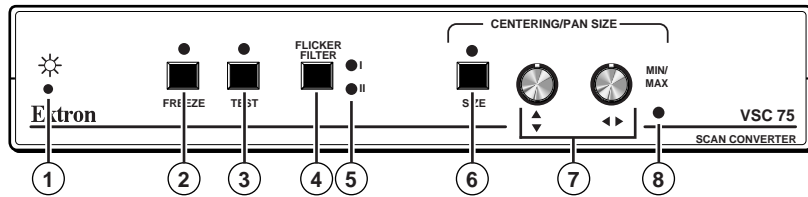

Figure 3 — VSC 75 front panel

**NOTE** Adjustments to front panel features and controls do not affect the local monitor.

- ① **Power/signal lock LED** — If this indicator...
  - **Lights amber yellow without blinking**, the VSC 75 is receiving power, but no input signal is present.
  - **Blinks green**, the unit is receiving power, but the input signal has a resolution that is too low or too high.
  - **Lights green without blinking**, the input signal is within range, and the VSC 75 has locked to that particular resolution.
- ② **Freeze button and LED** — Press this button to display (or record) a still image of the scan-converted picture from both display outputs. The freeze indicator LED lights while this control is active. To turn this feature off, press the Freeze button again. Freeze affects both outputs simultaneously. The image on the local monitor will not be frozen.

The LED lights to indicate that the freeze feature is active.

**NOTE** All controls *except* Freeze will be locked on the front panel while freeze mode is active. Press the Freeze button again to turn off freeze mode and unlock the other controls.

- ②+⑥ **Executive mode release (Freeze + Size)** — Press the Freeze button and the Size button simultaneously for 2 seconds to release executive mode. Executive mode, which can be activated only by issuing an RS-232 command (see page 3-5), prevents unauthorized or accidental adjustments to the VSC 75's settings via front panel controls by locking all the front panel features except centering

controls. Adjustments can still be made via RS-232 control when executive mode is active.

- ③ **Test button and LED** — Press this button to display a color bar test pattern on the output devices. The test indicator LED lights while this control is active. The test pattern continues to be displayed until you press the Test button again.

This LED lights to indicate that the test feature is active.

- ④ **Flicker filter button** — Press this button to choose one of the two levels of vertical filtering. Select the setting that yields the least amount of flicker.

- ⑤ **Flicker filter LEDs** — These LEDs light yellow to indicate the selected level of vertical filtering.

- ⑥ **Size button and LED** — Press this button to activate the size feature. When Size is active, the picture can be resized vertically and/or horizontally by rotating the vertical and horizontal Centering/Pan/Size rotary controls (10). Observe the picture on screen as you adjust the controls. To zoom in, adjust the size so the picture exceeds the screen's limits. The Min/Max LED (11) lights red when the minimum or maximum limit of a control has been reached.

The LED lights green to indicate that the size feature is active.

The size feature affects both display outputs simultaneously. The local monitor loop-out is not affected.

The size feature remains active for 8 seconds after the rotary controls become inactive. The rotary controls then default to the standard centering and pan functions. To turn the size feature off, press the Size button again.

See Freeze button (2) for information on using executive mode.

- ⑦ **Vertical (↕) and horizontal (↔) Centering/Pan/Size rotary controls** — Turn these knobs to adjust vertical or horizontal centering (when the image size does not exceed the screen size) and panning (when the image size exceeds the screen size) in the regular mode. Rotate these controls to adjust picture size when the size feature is active.



- ⑧ **Min/Max LED** — This lights red when the minimum or maximum limit of a control (6) has been reached.

## Rear Panel Features

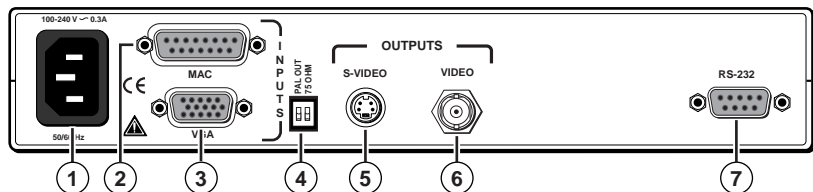

Figure 4 — VSC 75 rear panel

- ① **AC power input connector** — Connect a standard IEC AC power cord here for power input (100VAC to 240VAC, 50/60 Hz).
- ② **VGA computer input/Macintosh local monitor output connector** — Connect a VGA-type computer to the VSC 75 via this 15-pin D connector (and the provided Mac-VGA cable) to use a VGA-type computer as the video signal source. If a Macintosh, instead of a VGA-type PC, is used as a source, this connector serves as the Mac local monitor pass-through output connector.
- ③ **Macintosh (Mac) input/VGA local monitor output connector** — Connect a Macintosh computer to the VSC 75 via this 15-pin HD connector (and the provided Mac-VGA cable) to use a Mac as the video signal source. If a VGA/SVGA-type computer, instead of a Macintosh, is used as a source, this connector serves as the VGA local monitor pass-through output connector.
- ④ **DIP switches** — These two switches select the signal standard (NTSC or PAL) applied to the scan converted video output, and the video input termination (75 ohm or high impedance).
- 1 — **PAL Out** — Select the output standard with this switch. This switch affects both of the display outputs (composite video and S-video), but not the local monitor.

- ON** — The output is in **PAL** (Phase Alternate Line) format (625 lines/frame at 50 Hz vertical, 15.625 kHz horizontal).
- OFF** — The output is in **NTSC** (National Television Standards Committee) format (525 lines/frame at 60 Hz vertical, 15.734 kHz horizontal).

- 2 — **75 Ohm (video input termination)** — This switch provides a way to prevent blooming when no local monitor or termination adapter is connected.
- ON** — The VSC 75 provides 75 ohm video input termination. Select this setting when a local monitor is not used.
- OFF** — The VSC 75 provides high Z (high impedance) video input termination. Use this setting when the system includes a local monitor.

- ⑤ **S-video output connector** — This 4-pin mini-DIN connector is for S-video output.
- ⑥ **Composite video (Video) output connector** — Composite video output is continuously available on this BNC connector.
- ⑦ **RS-232 connector** — Connect a computer or RS-232 control module to this 9-pin D connector to allow remote control using the Simple Instruction Set or the Extron graphical control program for Windows. See chapter 3, "Serial Communication" for details.

## Cabling

Attach cables to the scan converter as detailed in the steps below. Figure 6 on page 2-9 shows how the system looks when cabling is finished.

1. Connect the local monitor via its video input cable to the corresponding (Mac or VGA) "input" connector on the VSC 75's rear panel.
2. Using the included Mac-VGA cable, connect the computer's video output to the other input connector. See figure 5 and the pin assignment information on page 2-9.
  - If the source computer is a Macintosh, plug the VGA (15-pin HD) end into the VSC 75, and plug

the other (15-pin D) end into the computer's video output connector.

- If the source computer is a VGA-type PC, plug the Mac (15-pin D) end into the VSC 75, and plug the other (15-pin HD) end into the computer's video output connector.

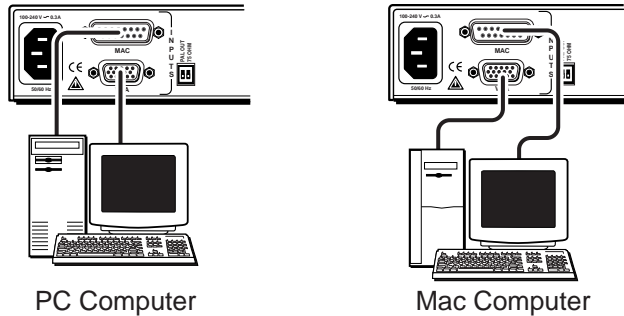

**Figure 5 — Mac-VGA cable local monitor connections**

If a local monitor will not be used, set the 75 Ohm DIP switch to On (75 ohms), or install a termination adapter on the unused local monitor connector.

3. Set the PAL Out (NTSC/PAL output) DIP switch. Use "Rear Panel Features" on page 2-6 as a guide.
4. Connect the composite video display or recording device to the composite video output BNC connector.
5. Connect a cable from the input of the second video display/recording device (projector, monitor, VCR) to the S-video output 4-pin mini-DIN connector.
6. If RS-232 control will be used, connect the RS-232 remote controller or computer to the RS-232 connector.
7. Connect power cords and turn on all the equipment.

The system is now ready for operation.

Figure 6 shows typical system installation and cable connections.

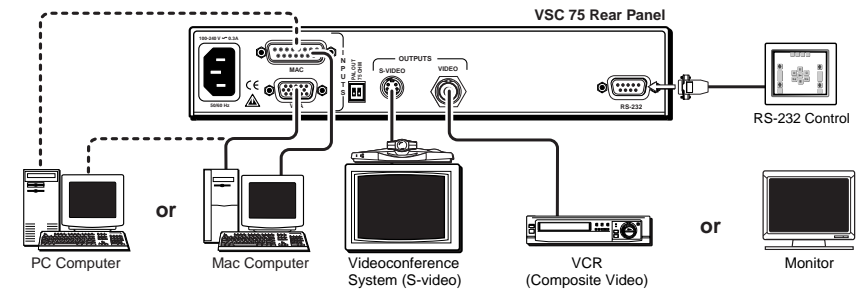

**Figure 6 — A typical VSC 75 system application**

### Mac-HV/VGA cable connector pin assignments

The illustration below shows the pin locations on the 15-pin connectors at opposite ends of the Mac-HV/VGA cable that is used for connecting the computer to the VSC 75.

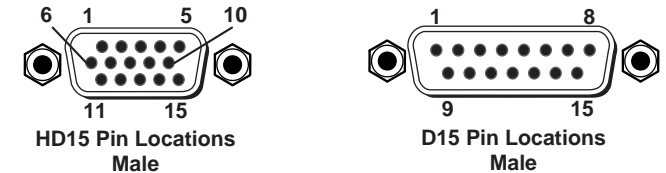

**Figure 7 — VGA (15-pin HD) and Mac (15-pin D) connector pin locations**

The table on the next page lists signals and their pin assignments for both the VGA (15-pin HD) and Mac (15-pin D) connectors of this cable.

VGA Pin	Function	Mac Pin
1	Red video	2
2	Green video	5
3	Blue video	9
4	ID bit	4
5	ID bit	8
6	Red ground	1
7	Green ground	6
8	Blue ground	13
9	Not used	—
10	Composite & vertical sync gnd	11, 14
11	ID bit	7
12	ID bit	10
13	Horizontal sync	15
14	Vertical sync	12
15	ID bit/composite sync	3

### Optimizing the Image

After you have installed the scan converter, follow the procedures in this section *in sequence*. This will help you configure the scan converter for the best settings for your display environment.

#### Select the output standard

1. Select the output standard with the PAL Out DIP switch. This switch affects both display outputs (composite video and S-video), but not the local monitor.

**ON** — The output is in **PAL** format.

**OFF** — The output is in **NTSC** format.

#### Size the image to fill the screen

1. Press the Size button on the front panel.
2. Rotate the vertical and horizontal Centering/Pan/Size rotary controls to adjust the vertical and horizontal size. Observe the picture on screen as you adjust the controls. The Min/Max LED will light red when the minimum or maximum limit of a control is reached.

The size feature affects both display outputs, but local monitor loop-out is not affected. The size function remains active for 8 seconds after the rotary controls become inactive. The rotary controls then default to the standard centering and pan functions.

3. Press the Size button again to turn the size feature off.
4. Center the picture by rotating the horizontal and vertical Centering/Pan/Size rotary controls.
5. Repeat steps 1 through 4 as needed.

#### Select the filtering level

1. Press the flicker filter button to select the filtering level that gives the least amount of flickering. The LEDs next to the flicker button will light to indicate the selected level of filtering.

**NOTE** *If the filter is set before the image size is adjusted, you must set the filter again after adjusting the image size.*

### Troubleshooting

The image should appear properly on the screen(s).

#### If the image does not appear

1. Ensure that all devices are plugged in.
2. Make sure that each device is receiving power.
3. Check the cabling, wiring and grounding, and make adjustments as needed. Ensure that the rear panel output selection toggle switch and PAL Out DIP switch are set for the formats that match the cable configuration and the requirements of the display/recording devices.
4. Verify that the 75 Ohm video input termination DIP switch has been set correctly.
5. To test the system setup and output, press the Test button on the front panel, or substitute a video test generator for the computer input.
6. Confirm that the input is receiving a signal with a compatible scan rate (horizontal frequency between 24 kHz and 70 kHz, and a vertical frequency of 50 Hz to 120 Hz).
7. Call Extron's customer support hotline if needed. Be prepared to discuss the steps you have taken and the equipment involved.



#### If the image is not displayed correctly

Symptoms	Solutions
The picture is shifted off the screen edges.	Adjust the centering and sizing controls (◆, ◀▶).
The image is stable, but it has ghosting or blooming.	Change the 75 ohm/high Z video input termination. If that doesn't solve the problem, use a different input cable.
The picture is faint or cuts out, and the signal is weak.	Video input may be double-terminated. If a local monitor or a termination adapter is attached to the local monitor output connector, make sure that the 75 Ohm video input termination DIP switch is set to Off (for high Z termination).
The picture appears without color.	Adjust the hue/tint and color controls on the display device. Make sure that the video display/recording equipment is using the same standard (NTSC or PAL) as the VSC 75.
The image still does not display correctly.	Call Extron's customer support hotline.

#### If the scan converter does not respond to controls

Symptoms	Solutions
The picture does not move on screen when the horizontal and vertical centering controls are rotated, and the flicker filter setting does not change when the flicker filter button is pressed.	The VSC 75 may be set for Executive mode. Adjustments can be made via RS-232 control, or... Executive mode can be turned off by pressing the Freeze and Size controls simultaneously for 2 seconds. See page 2-4.
There is no response to commands from the RS-232 controller.	Ensure that the baud rate (9600 baud) and communication protocol are set correctly. See page 3-2.

# 3

## Chapter Three

### Serial Communication

RS-232 Programmer's Guide  
Control Software for Windows

# Serial Communication

The VSC 75 can be controlled by a host computer or other control device via an RS-232 connection with a protocol of 9600 baud, 1 stop bit, no parity, and no flow control. The control device (host) can use either Extron's Simple Instruction Set (SIS) or the graphical control program for Windows.

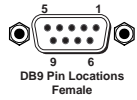

The rear panel RS-232 9-pin D connector has the following pin assignments:

Pin	RS-232 function	Description
1	-	Not used
2	Tx	Transmit data
3	Rx	Receive data
4	-	Not used
5	Gnd	Signal ground
6	-	Not used
7	-	Not used
8	-	Not used
9	-	Not used

## RS-232 Programmer's Guide

SIS commands consist of one or more characters per field. No special characters are required to begin or end a command sequence. When the VSC 75 determines that a command is valid, it executes the command and sends a response to the host device. All responses from the scan converter to the host end with a carriage return and a line feed (CR/LF = ↵), which signals the end of the response character string. A string is one or more characters.

### VSC-initiated messages

When a local event such as a front panel selection or adjustment takes place, the VSC 75 responds by sending a message to the host. No response is required from the host. The VSC-initiated messages are listed here (underlined).

(C) COPYRIGHT 2000, EXTRON ELECTRONICS VSC 75, Vx.xx ↵

The VSC 75 displays the copyright message when it first powers on. Vx.xx is the firmware version number.

RECONFIG ↵ The VSC 75 sends the Reconfig message when the input source is changed and when changes have been made to one or more of the settings.

### VSC error responses

When the VSC 75 receives a valid SIS command, it executes the command and sends a response to the host device. If the VSC 75 is unable to execute the command because the command is invalid or it contains invalid parameters, it returns an error response to the host. The error response codes and their descriptions are as follows:

E09 – Invalid function number (the number is too large)

E10 – Invalid command

E13 – Invalid value (the number is out of range).

### Time-out

A delay of 10 or more seconds between command sequence characters causes a time-out. The command operation is stopped, and there is no indication that a time-out occurred.

### Using the command/response table

The command/response table on the next page lists valid command ASCII codes, the VSC 75's responses to the host, a description of the command's function or the results of executing the command, and an example of each command. Lower case characters are acceptable in the command field only where indicated.

The ASCII to HEX conversion table below is for use with the command/response table.

ASCII to HEX Conversion Table										Esc 1B	CR 0D	LF 0A		
20	!	21	"	22	#	23	\$	24	%	25	&	26	'	27
( 28	) 29	* 2A	+ 2B	, 2C	- 2D	. 2E	/ 2F							
0 30	1 31	2 32	3 33	4 34	5 35	6 36	7 37							
8 38	9 39	: 3A	; 3B	< 3C	= 3D	> 3E	? 3F							
@ 40	A 41	B 42	C 43	D 44	E 45	F 46	G 47							
H 48	I 49	J 4A	K 4B	L 4C	M 4D	N 4E	O 4F							
P 50	Q 51	R 52	S 53	T 54	U 55	V 56	W 57							
X 58	Y 59	Z 5A	[ 5B	\ 5C	] 5D	^ 5E	_ 5F							
` 60	a 61	b 62	c 63	d 64	e 65	f 66	g 67							
h 68	i 69	j 6A	k 6B	l 6C	m 6D	n 6E	o 6F							
p 70	q 71	r 72	s 73	t 74	u 75	v 76	w 77							
x 78	y 79	z 7A	{ 7B	7C	} 7D	~ 7E	DEL 7F							

**Symbol definitions**

- ↵ = CR/LF (carriage return/line feed)
- ← = CR (carriage return only)
- = Space

- [x1] = Vertical filtering level (1 through 2)
- [x2] = 1 = On, 0 = Off

<b>Command/response table</b>				
Command description	Command		Response to host	Additional description
	ASCII	Hex		
<b>Horizontal shift</b>				
Shift right one step	{ H	7B + 48	Hph + ↵	Increment up
Shift left one step	} H	7D + 48	Hph - ↵	Increment down
<b>Vertical shift</b>				
Shift down one step	{/	7B + 2F	Vph + ↵	Increment up
Shift up one step	}/	7D + 2F	Vph - ↵	Increment down
<b>Horizontal size</b>				
Increase horizontal size by one step	{:	7B + 3A	Hsz + ↵	Increment up
Decrease horizontal size by one step	}:	7D + 3A	Hsz - ↵	Increment down
<b>Vertical size</b>				
Increase vertical size by one step	{:	7B + 3B	Vsz + ↵	Increment up
Decrease vertical size by one step	}:	7D + 3B	Vsz - ↵	Increment down
<b>Flicker/vertical filter (detail)</b>				
Select flicker/vertical filter [x1] (Dvt)	[x1] d	[x1] + 64	[x1] Dvt ↵	Specific value
Select next higher flicker/vertical filter (Dhz + 1)	{ d	7B + 64	Dvt [x1] ↵	Increment up
Select next lower flicker/vertical filter (Dhz - 1)	} d	7D + 64	Dvt [x1] ↵	Increment down

<b>Freeze</b>				
Set Freeze mode to On (freeze the displayed image)	F	46	Frz 1 ↵	Enable freeze
Set Freeze mode to Off (release the displayed image)	f	66	Frz 0 ↵	Disable freeze
<b>Executive mode</b>				
Set Executive mode to On	X	58	Exe 1 ↵	Enable executive
Set Executive mode to Off	x	78	Exe 0 ↵	Disable executive
<b>Test mode</b>				
Set Test mode to On	J	4A	Dmo 1 ↵	Enable test
Set Test mode to Off	j	6A	Dmo 0 ↵	Disable test
<b>Firmware version, part number &amp; information requests, and reset</b>				
System reset	Esc z ←	1B 7A 0D	Zap ↵	Reset to factory default
Query firmware version number	Q/q	51/71	Ver x.xx ↵	Display firmware version
Request part number	N/n	4E/6E	N60-321-01 ↵	Display VSC 75's part #
Request information	Command =	I/i	49/69	(see below)
	Response =	Dvt [x1] • Frz [x2] • Exe [x2] ↵ • Dmo [x2] ↵		

### Control Software for Windows

The included graphical control software for Windows offers another way to control the VSC 75 via RS-232 connection in addition to the Simple Instruction Set commands listed on pages 3-4 to 3-5. The control software is compatible with Windows 3.1/3.11, Windows 95/98 and Windows NT. The VSC 75 uses version 3.2 or higher of Extron's VSC and DDS Control Program, which is included with the VSC 75.

#### Installing the software

The control program is contained on a single 3.5-inch diskette, and it can run from the floppy drive. However, it is more convenient to run the program from the hard drive.

To install the software on the hard drive, run SETUP.EXE from the floppy disk, and follow the instructions that appear on the screen. The program requires approximately 1 MB (megabyte) of hard disk space.

By default, the installation creates a C:\VSC200 directory, and it places two icons (VSC + DDS Control Pgm and VSC + DDS Help) into a group or folder named "Extron Electronics".

#### Using the software

1. To run the VSC and DDS Control Program, double-click on the VSC + DDS Control Pgm icon in the Extron Electronics group or folder. The Comm menu appears on the screen.  
  
VSC + DDS  
Control Pgm
2. Click on the comm port that is connected to the VSC 75's RS-232 port. The Extron VSC and DDS Control Program window appears. It displays the current settings. See figure 8 on the next page.

For information on program features, press the F1 computer key or click on the Help menu from within the control program, or double-click on the VSC + DDS Help icon in the Extron Electronics group or folder.  
  
VSC + DDS  
Help



Figure 8 — VSC and DDS Control Program window



# A

## Appendix

### Specifications Part Numbers and Accessories

Specifications

Included Parts

Accessories



# Specifications

## Video input

Number/signal type .....	1 VGA, 1 Mac analog RGBHV, RGBS, RGB
Connectors .....	VGA ..... 15-pin HD female Mac ..... 15-pin D female
Nominal level(s) .....	Analog — 1V p-p
Minimum/maximum level(s) ....	Analog — 0V to 2V p-p with no offset
Impedance .....	75 ohms or high Z (DIP switch selectable)
Horizontal frequency .....	Autoscan 24 kHz to 70 kHz
Vertical frequency .....	Autoscan 50 Hz to 120 Hz
Resolution range .....	Autoscan 560 x 384 to 1280 x 1024 Note: 1280 x 1024 is available at 60 Hz only

## Video processing

Encoder .....	10 bit digital
Digital sampling .....	24 bit, 8 bits per color; 50 MHz standard
Colors .....	16.8 million
Horizontal filtering.....	1 level
Vertical filtering .....	2 levels (selectable)

## Video output

Number/signal type .....	1 S-video ..... NTSC 15.75 kHz, 525/625 lines, or PAL, 15.5 kHz, 625 lines 1 composite video — NTSC 15.75 kHz, 525 lines, or PAL 15.5 kHz, 625 lines
Connectors .....	S-video ..... 1 4-pin mini-DIN female Composite video ..... 1 BNC female
Nominal level .....	1V p-p
Impedance .....	75 ohms

## Sync

Input type .....	Autodetect RGBHV, RGBS, RGB
Standards .....	NTSC 3.58, PAL
Input level .....	1.5V to 5V p-p
Input impedance .....	75 ohms

## Control/remote — scan converter

Serial control port .....	RS-232, 9-pin female D connector
Baud rate and protocol .....	9600, 8-bit, 1 stop bit, no parity
Serial control pin configurations ...	2 = TX, 3 = RX, 5 = GND
Program control .....	Extron's control program for Windows® Extron's Simple Instruction Set™ – SIS™

## General

Power .....	100VAC to 240VAC, 50/60 Hz, 40 watts, internal, auto-switchable
Temperature/humidity .....	Storage -40° to +158°F (-40° to +70°C) / 10% to 90%, non-condensing Operating +32° to +122°F (0° to +50°C) / 10% to 90%, non-condensing
Rack mount.....	Yes, with optional rack shelf, part number 60-190-01
Enclosure type .....	Metal
Enclosure dimensions .....	1.75" H x 8.75" W x 9.50" D 4.45 cm H x 22.23 cm W x 24.13 cm D
Shipping weight .....	5 lbs (2.3 kg)
Vibration .....	NSTA 1A in carton (National Safe Transit Association)
Approvals .....	UL, CE, FCC Class A
MTBF .....	30,000 hours
Warranty .....	2 years parts and labor

**NOTE** Specifications are subject to change without notice.

## Accessories and Part Numbers

---

### Included Parts

These items are included in each order for a VSC 75:

Included parts	Part number
VSC 75	60-321-01
Mac-HV/VGA cable (6 feet)	26-462-01
S-video cable (6 feet)	26-316-02
VSC 75 user's manual	68-483-01
VSC/DDS control software for Windows version 3.1 or higher	29-038-01

### Accessories

Accessories	Part number
1U rack shelf	60-190-01



## Free Manuals Download Website

<http://myh66.com>

<http://usermanuals.us>

<http://www.somanuals.com>

<http://www.4manuals.cc>

<http://www.manual-lib.com>

<http://www.404manual.com>

<http://www.luxmanual.com>

<http://aubethermostatmanual.com>

Golf course search by state

<http://golfingnear.com>

Email search by domain

<http://emailbydomain.com>

Auto manuals search

<http://auto.somanuals.com>

TV manuals search

<http://tv.somanuals.com>