

The manufacturer reserves the right to modify the items described in this brochure.

El fabricante se reserva el derecho de modificar los modelos descritos en el presente libro de instrucciones.

Le fabricant se réserve le droit de modifier les modèles décrits dans la brochure.

# duo PRESSURE COOKER

The Single Most Important  
Piece of Cookware  
You'll Ever Own

User's Manual



Shop online for  
replacement parts and  
accessories at:

[www.fagoramerica.com](http://www.fagoramerica.com)

**FAGOR** 

MADE IN SPAIN

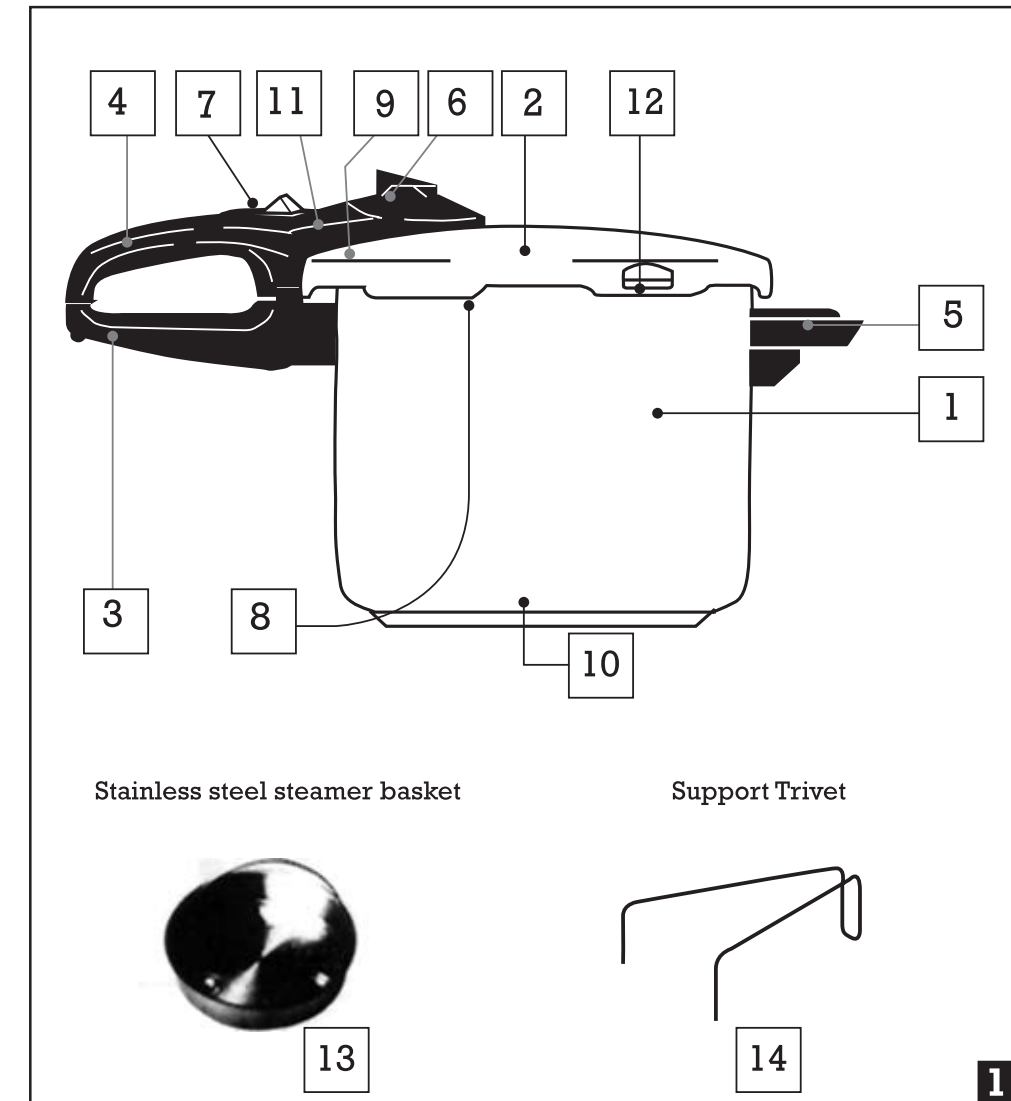

Stainless steel steamer basket

Support Trivet

1. Pressure Cooker Pot
2. Lid
3. Base Handle
4. Lid Handle
5. Support Grip
6. Operating Valve

7. Pressure Safety Lock
8. Rubber Gasket
9. Automatic Safety Valve
10. Thermo Heat Conductive Base
11. Indicator
12. Safety Vent
13. Steamer Basket
14. Trivet

**FAGOR AMERICA, INC.**  
PO Box 94  
Lyndhurst, N.J. 07071  
Web page: [www.fagoramerica.com](http://www.fagoramerica.com)  
Email: [info@fagoramerica.com](mailto:info@fagoramerica.com)

Figures 2-9 (as discussed in User's Manual)

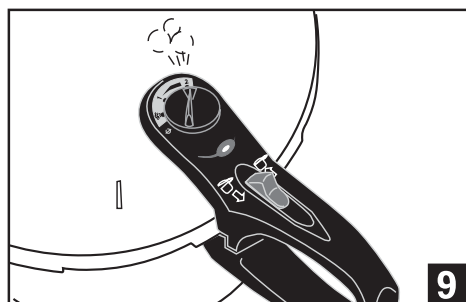
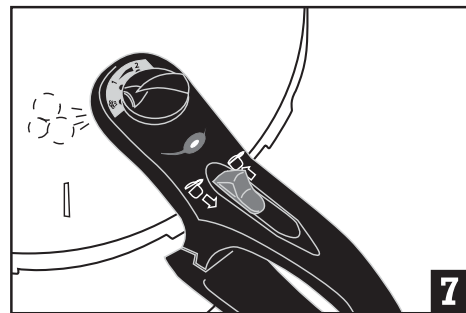
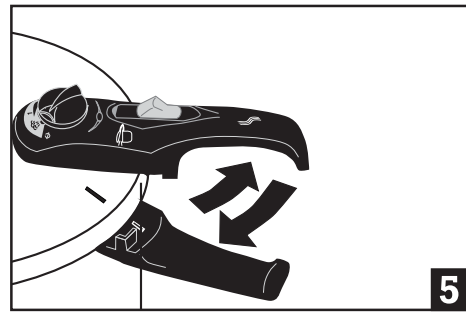
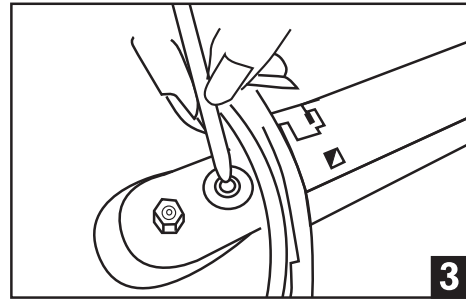
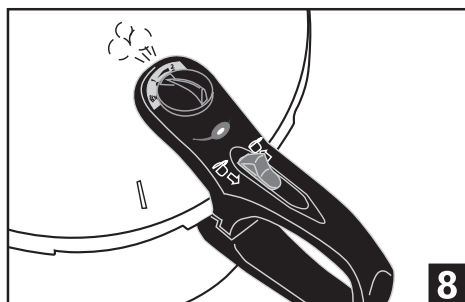
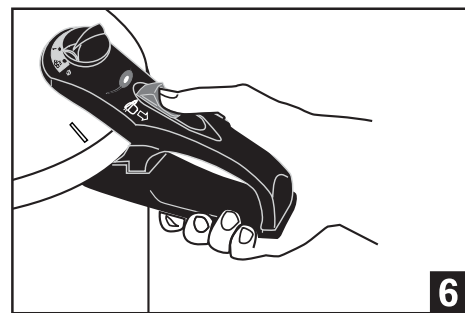
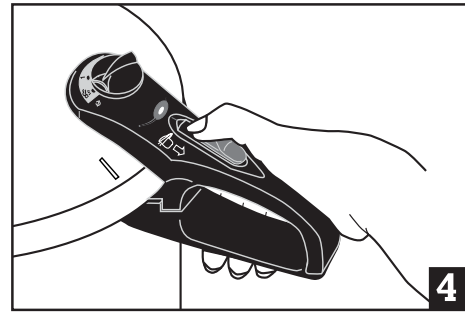

Figures 10-16 (as discussed in User's Manual)

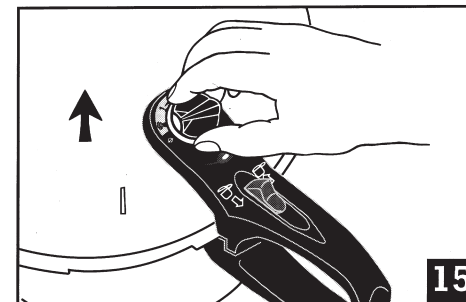
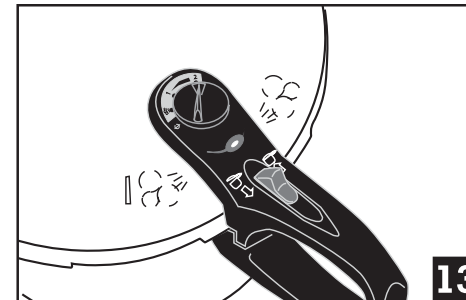
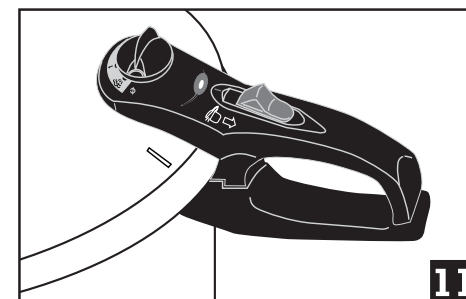
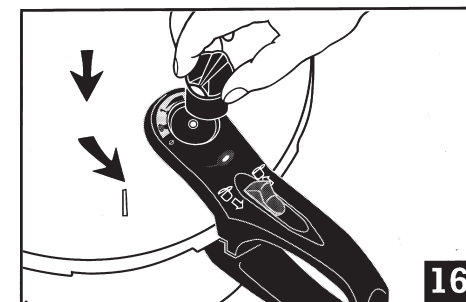
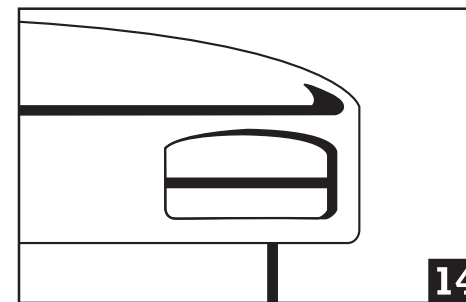
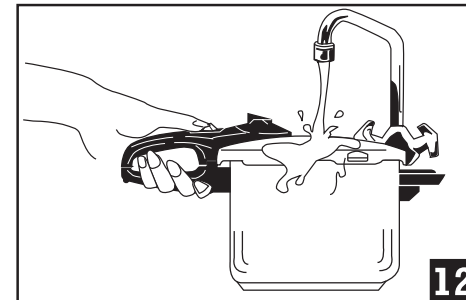
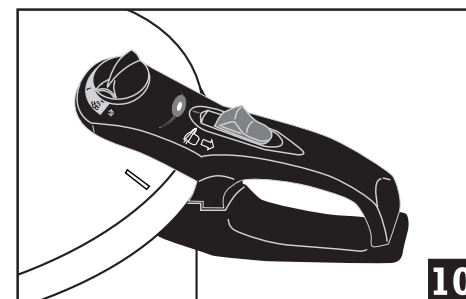

## LIMITED WARRANTY

This pressure cooker is guaranteed to be free from defects in material and workmanship for a period of TEN YEARS from the date of purchase by the first user, provided that the unit is used in accordance with the use and care instructions supplied, and for household use only.

Moving and/or perishable parts such as gaskets, internal component parts, etc. which are subject to normal wear and tear are excluded from the warranty.

Also excluded are all defects resulting from accident, damaged suffered in transit, misuse or negligence (including overheating and boiling dry), normal wear and tear such as scratches, dulling of the polish or staining, etc., and repairs or manipulations carried out by unauthorized or non-qualified personnel.

If repairs become necessary during the warranty period, please return the unit, postage pre-paid to:

FAGOR AMERICA, INC.  
SERVICE DEPARTMENT  
745 GOTHAM PARKWAY  
CARLSTADT, NJ 07072

After inspection to confirm that the claim satisfies the warranty conditions, the defective piece will, at the discretion of the manufacturer, be repaired or replaced free of charge.

This warranty is in lieu of all other warranties and representations expressed or implied and all other obligations or liabilities on our part.

Incidental or consequential damages are excluded. Some states do not allow exclusions or limitations on incidental or consequential damages or on implied warranties so the above exclusions or limitations may not apply to you.

This warranty gives you specific legal rights and you may have other rights which vary from state to state.

For spare parts or assistance not requiring the return of the product itself, please contact our Customer Service Department at 1-800-207-0806.

## FAGOR AMERICA, INC. WARRANTY REGISTRATION CARD

Mr./Mrs./Ms.: \_\_\_\_\_

Telephone: \_\_\_\_\_

Address: \_\_\_\_\_

Email address: \_\_\_\_\_

Date of Purchase: \_\_\_\_\_

Name of Dealer: \_\_\_\_\_

Suggestion: \_\_\_\_\_

Name of Product: \_\_\_\_\_

Model No: \_\_\_\_\_

Size: \_\_\_\_\_

**Important Notice:** Please complete and mail this warranty registration card immediately to protect your warranty service. You can also register your pressure cooker online at [www.fagoramerica.com](http://www.fagoramerica.com)

## Free Manuals Download Website

<http://myh66.com>

<http://usermanuals.us>

<http://www.somanuals.com>

<http://www.4manuals.cc>

<http://www.manual-lib.com>

<http://www.404manual.com>

<http://www.luxmanual.com>

<http://aubethermostatmanual.com>

Golf course search by state

<http://golfingnear.com>

Email search by domain

<http://emailbydomain.com>

Auto manuals search

<http://auto.somanuals.com>

TV manuals search

<http://tv.somanuals.com>