

**FANTOM®**

# Electric Leaf Blower

## OWNER'S MANUAL

**Model PT199H**

120V., 60Hz., 12 Amps

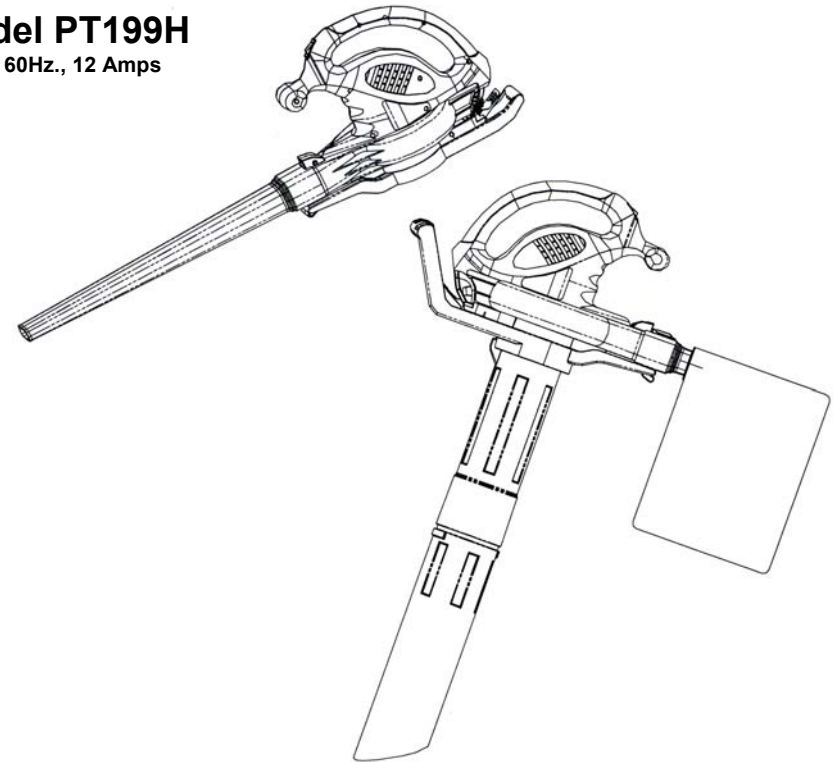

### **⚠ CAUTION**

Before using this Leaf Blower, read this manual and follow all its Safety Rules and Operating Instructions.

- Safety Instructions
- Accessories
- Assembly
- Operation
- Maintenance

FANTOM, 94 Main Mill Street, Door 16, Plattsburgh, N.Y. 12901  
Tel.: 1 (800) 275-9251





## ONE (1) YEAR LIMITED WARRANTY

FANTOM warrants this product to be free from defects in material and workmanship for a period of one (1) year from the date of the original purchase, when utilized for normal household use, subject to the following conditions, exclusions and exceptions.

If your appliance fails to operate properly while in use under normal household conditions within the warranty period, return the complete appliance and accessories, freight prepaid to:

**FANTOM, 94 Main Mill Street, Door 16, Plattsburgh NY 12901**

If the appliance is found by FANTOM to be defective in material or workmanship, FANTOM will repair or replace it free of charge. Proof of purchase date and \$ 18.95 to cover the cost of return shipping and handling must be included. \*

Non-durable parts including, without limitation, blades and electrical parts which normally require replacement are specifically excluded from warranty.

The liability of FANTOM is limited solely to the cost of the repair or replacement of the unit at our option. This warranty does not cover normal wear of parts and does not apply to any unit that has been tampered with or used for commercial purposes. This limited warranty does not cover damage caused by misuse, abuse, negligent handling or damage due to faulty packaging or mishandling in transit. This warranty does not cover damage or defects caused by or resulting from damages from shipping or repairs, service or alterations to the product or any of its parts, which have been performed by a repair person not authorized by FANTOM.

This warranty is extended to the original purchaser of the unit and excludes all other legal and/or conventional warranties. The responsibility of FANTOM if any, is limited to the specific obligations expressly assumed by it under the terms of the limited warranty. **In no event** is FANTOM liable for incidental or consequential damages of any nature whatsoever. Some states do not permit the exclusion or limitation of incidental or consequential damages, so the above may not apply to you.

This warranty gives you specific legal rights, and you may also have other rights which vary from state to state.

**\*Important: Carefully pack item to avoid damage in shipping. Be sure to include proof of purchase date and to attach tag to item before packing with your name, complete address and phone number with a note giving purchase information, model number and what you believe is the problem with item. We recommend you insure the package (as damage in shipping is not covered by your warranty). Mark the outside of your package "ATTENTION CUSTOMER SERVICE". We are constantly striving to improve our products, therefore the specifications contained herein are subject to change without notice.**



### OWNERSHIP REGISTRATION CARD

Please fill out and mail the product registration card within ten (10) days of purchase. The registration will enable us to contact you in the unlikely event of a product safety notification. By returning this card you acknowledge to have read and understood the instructions for use, and warnings set forth in the accompanying instructions.

**RETURN TO FANTOM: 94 Main Mill Street, Door 16, Plattsburgh, NY 12901**

**Model PT199H**

Appliance model

Date purchased

Name of store

Owner's name

Address

City

State

Zip Code

# SAFETY & WARNING INSTRUCTIONS



**WARNING! THIS MACHINE CAN CAUSE SERIOUS INJURIES.** When using electric gardening appliances basic safety precautions should always be followed to reduce the risk of fire, electric shock and personal injury. The warnings and safety instructions in this manual must be followed to provide reasonable safety and efficiency in using this unit. Carefully read and understand the entire owner's manual before using your Leaf Blower. Be thoroughly familiar with the controls and the proper use of this unit. Restrict the use of this unit to persons who read, understand and follow unit and manual instructions and warnings. Pay close attention to the Operating Instructions and Safety Warnings.

## READ ALL INSTRUCTIONS BEFORE USING

1. Wear safety glasses or goggles that are marked as meeting ANSI Z87.1 standards and ear/hearing protection when operating this unit. wear a face or dust mask if the job is dusty.
2. Do **NOT** leave the leaf blower plugged in. Unplug from electrical outlet when not in use, changing from blower to vacuum, if the appliance starts to vibrate abnormally, during maintenance or before servicing.
3. Only operate this unit in natural daylight or good artificial light.
4. Avoid dangerous environments. Never operate your unit in damp or wet conditions. Moisture is a shock hazard. Avoid using near pools, hot-tub areas, etc.
5. Do **NOT** use the leaf blower in the rain.
6. Do **NOT** handle the unit with wet hands.
7. **Use the right tool for the right job.** Use the unit only as described in this manual. Do **NOT** use for any job except that for which it is intended. This unit is intended for household use only.
8. Always direct the extension cord to the rear of the leaf blower. Ensure that it is firmly attached to the rear power cord hook.
9. Inspect the area to be cleared before each use. Remove all objects such as rocks, sticks, gravel, or other debris that can ricochet and cause injury.
10. Do **NOT** unplug by pulling on the power cord. To unplug, grasp the plug, not the cord.
11. Keep hair, loose clothing, fingers and parts of the body away from openings and moving parts.
12. Do **NOT** allow to be used as a toy. Close attention is necessary when used by or near children.
13. Inspect all extension cords and the unit power connection periodically. Look closely for deterioration, cuts or cracks in the insulation. Also inspect the connections for damage. Replace the cords if any defects or damage appear.
14. Risk of cuts. Keep hands away from impeller. Keep both hands on handles when power is on.



**WARNING:** The operation of any leaf blower can result in foreign objects being thrown in the eyes. This can lead to severe eye damage. Before commencing power tool operation always wear safety glasses or goggles that are marked as meeting ANSI Z87.1 standards and a full face shield when needed.

# SAVE THESE INSTRUCTIONS

## For Household Use Only

# SAFETY & WARNING INSTRUCTIONS

15. Before each use, thoroughly inspect your unit for loose or damaged parts. Do **NOT** use until adjustments or repairs have been made.
16. All attachments must be installed properly before operating the unit, such as debris collector bag.
17. Keep all bystanders especially pets and children at least fifty (50) feet from the unit while using.
18. To avoid unintentionally starting of the unit, do **NOT** carry plugged-in unit with your finger on the switch. Be sure the unit is unplugged.
19. Always remain alert and use common sense when using this unit. To prevent injury to yourself and to others, **NEVER** use the leaf blower when you are tired.
20. **DO NOT** operate this unit while under the influence of drugs, alcohol or medication.
21. Do **NOT** over reach or use the leaf blower from unstable surfaces such as ladders, trees, steep slopes, rooftops, etc. Keep proper footing and balance at all times.
22. Wear heavy, long pants, boots, gloves and a long sleeve shirt. Do **NOT** wear loose clothing, jewelry, short pants sandals or go barefoot. Secure hair above shoulder level.
23. Always turn switch off when vacuuming or blowing is delayed or when changing locations. **Always** inspect new locations before operating.
24. To reduce the risk of electrical shock, use only with an extension cord intended for outdoor use such as SW-A, SOW-A, STW-A, STOW-A, SJW-A, SJOW-A, SJTW-A or SJTOW-A.0
25. Ground Fault Circuit Interrupter (GFCI) protection should always be provided on electrical circuits or outlets to be used for this unit.
26. To reduce the risk of electrical shock, use only with a two conductor extension cord intended for outdoor use.
27. Never connect the unit to an AC voltage that differs from the one on the unit's rating plate.

28. To reduce the risk of electrical shock, this unit has a polarized plug (one blade is wider than the other) and will require the use of a polarized extension cord. This unit plug will fit into a polarized extension cord only one way. If the plug does not fit, obtain a correct polarized extension cord. A polarized extension cord requires the use of a polarized wall outlet. This plug will fit into a polarized wall outlet only one way. If the plug does not fit, contact a qualified electrician to install the proper wall outlet. Do **NOT** change the unit plug, extension cord receptacle or extension cord plug in any way.
29. When using an extension cord, make sure that it is a cord that is heavy enough to carry the current that your unit will draw. An undersized extension cord will cause a drop in line voltage resulting in loss of power and overheating. The table below shows the correct size to use depending on the cord length and amperage rating.
30. Keep impeller clean of vegetation and other foreign materials. Cooling air inlets may become clogged with debris. Overheating the unit can increase risk of fire or injury.
31. When using the unit, always hold the unit with both hands. Keep a firm grip on the front handle and on the top handle.

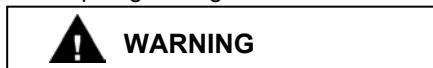

## WARNING

To reduce the risk of electrocution, keep all connections dry and off the ground. Do not touch the plug with wet hands.

	Extension Cord Length			
	25'	50'	100'	150'
AMPERAGE RATING	WIRE SIZE (AWG)			
1-10 AMPS	18	16	14	12

# MAINTENANCE

## Removing Debris from Clogged Impeller

1. Turn off and unplug the vacuum from the power source and wait for all moving parts to stop.
2. Remove the easy grip handle, or the inlet cover.
3. Remove blockage. If necessary dislodge blockage with a wooden stick.
4. Check the impeller for any signs of damage. If damage to any parts have occurred contact customer service at 1 (800) 275-9251.
5. Install the vacuum tube or, if you want to switch to blower mode see instructions for correct procedure.

## Cleaning Bag and Tubes

Best performance is achieved with proper cleaning and maintenance.

1. Unplug unit from power source, and ensure all parts have stopped moving.
2. Empty bag according to instructions on page 10.
3. To clean bag, turn inside out and hose down the bag.

4. Air dry for 24hrs.
5. Do Not install onto unit until bag is completely dry.
6. To clean tubes, remove from unit first, then use a hose to clear grass or leaves stuck inside of tubes.

**WARNING:** Never douse or squirt motor with water or any other liquid. Keep handles and tubes dry, clean and free from debris.

## Storage of Leaf Blower

1. Store unit and extension cord in a indoors.
2. Keep out of reach of children.
3. Tubes can be stored upright after assembly, however ensure that there are no sharp objects that can damage tubes.
4. Do not store tubes under any other items. This can cause permanent dents in the tubes.

# TROUBLESHOOTING

## TROUBLESHOOTING GUIDE

SYMPTOM	CAUSE	REMEDY
Unit fails to operate	<ol style="list-style-type: none"> <li>1. Switch in the OFF position.</li> <li>2. Extension cord disconnected</li> <li>3. Circuit breaker tripped, or fuse blown.</li> <li>4. Mechanical failure.</li> </ol>	<ol style="list-style-type: none"> <li>1. Move switch to ON position.</li> <li>2. Reconnect extension cord.</li> <li>3. Reset circuit breaker or fuse.</li> <li>4. Contact FANTOM Customer Service at 1 (800) 275-9251.</li> </ol>
Unit vibrates abnormally	<ol style="list-style-type: none"> <li>1. Mechanical failure.</li> <li>2. Blockage to parts.</li> </ol>	<ol style="list-style-type: none"> <li>1. Contact FANTOM Customer Service at 1 (800) 275-9251.</li> <li>2. Inspect unit for blockage.</li> </ol>
Impeller will not turn freely	<ol style="list-style-type: none"> <li>1. Debris in air intake area.</li> <li>2. Mechanical failure.</li> </ol>	<ol style="list-style-type: none"> <li>1. Unplug and clear unit of debris.</li> <li>2. Contact FANTOM Customer Service at 1 (800) 275-9251.</li> </ol>

## OPERATING INSTRUCTIONS

**NOTE:** IF the vacuum starts to vibrate or make an abnormal sound, stop the unit, unplug from power source, and check for the cause.

5. Wrap bag's shoulder strap and cross chest while holding unit with both hands. (Fig. 20)

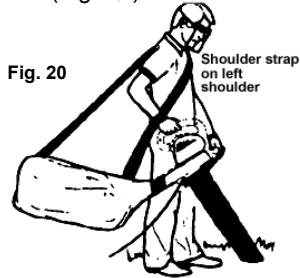

**WARNING:** Do not use leaf blower to spread fertilizer or clear any kind of powered or other chemicals. This is highly dangerous and could cause serious harm to operator and environment.

### Emptying the Bag

1. Turn off and unplug the vacuum from power source. Wait until all parts stop moving.
2. Detach from blower outlet.
3. Unzip the bag over a receptacle for debris, such as a garbage bag, or compost bin.
4. Gently shake bag to ensure it is empty.
5. Zipper must be closed to end to ensure bag will not leak or throw objects. (Fig. 21)



**CAUTION:** Do not store debris in bag, this could cause damage to the fabric, leading to further injury or damage to the unit.

**NOTE:** Check bag frequently for wear. Small tears in bag will easily enlarge. If bag shows signs of wear replace only with bag suggested by manufacturer.

## SAFETY & WARNING INSTRUCTION

32. The unit will continue to run for a few seconds after the power is switched off.
33. **Do Not** rest the unit on any surface while the unit is running. Debris such as gravel, sand, dust, grass etc. could be picked up by the air intake and thrown out through the discharge opening, damaging the unit, property, or causing serious injury to any person nearby.
34. **Never** run the unit without the proper attachments. When used as a blower, always install a blower tube. Use only factory approved attachments provided with the leaf blower.
35. **Do Not** use with any opening blocked. Keep free of dust, lint, hair or other objects that may reduce air flow.
36. To avoid accidental fire, do not use blower near leaf or brush fires, fireplaces, barbecue pits, ashtrays.
37. **Do Not** use for spreading chemicals, fertilizers, or any other substances which may contain toxic materials.
38. Store the unit in a dry place either locked up or on a high shelf out of the reach of children to prevent unauthorized use or damage.
39. **Do Not** place objects inside blower tube or aim blowing debris towards people, animals, glass, or solid objects such as cars, trees, walls etc. The force of the air can throw objects with enough force to seriously damage or harm people or objects.
40. Allow motor to stop and disconnect power source before opening the air inlet attachment or to insert or remove the vacuum tubes. The **motor must be stopped** and the impeller blades should no longer be turning to avoid serious injury from the rotating fan-like blades.
41. Inspect debris collector bag **BEFORE** each use. Ensure that bag is firmly zippered shut before use.  
**WARNING:** Hard objects can be thrown through the debris collector bag or the housing and become dangerous missiles which can seriously injure operator or bystanders.
42. When using the vacuum attachment **do not** vacuum up stones, gravel, glass, metal or other objects that could damage debris collector bag. The bag is intended **ONLY** for dry materials such as leaves, grass and very small twigs.
43. **Do Not** vacuum up discarded matches, cigarettes, ashes, coal, or fireplace pits. Avoid any flammable or hot objects. Inspect area to be vacuumed carefully.
44. **Never** vacuum up damp or moist materials or vacuum water or other liquids. Allow leaves or grass to dry before collecting in debris collector bag.
45. **Never** run vacuum without the proper installation of parts. When using the vacuum, always install vacuum tubes and debris collector bag according to instructions.
46. Stop and disconnect unit from power source. Inspect all openings and tubes frequently, to ensure safety from overheating and fire.
47. **NEVER** douse or squirt the unit with water or any other liquid. Keep handles dry, clean and free from debris. Clean after every use. See cleaning and storage section for further instructions.
48. **Do NOT** operate this unit in explosive atmospheres, such as in the presence of flammable liquids, gases or dust.

# SAFETY & WARNING INSTRUCTION

49. **Make sure that bystanders, pets, and children are at least 50 feet from blower or vacuum to avoid serious injury from objects that may be propelled by unit.**

**!** This unit can violently propel objects. It is advised that you wear protective safety clothing, ie: long pants, covered shoes, face mask, and safety glasses.

**!** Disconnect unit from power source before performing maintenance or when converting the unit from one function to another.

**!** All Electrical repairs to this unit, including housing, motor, etc., must be diagnosed by a qualified service personnel. Replacement parts for a double insulated appliance must be recommended by the manufacturer.

## **!** WARNING

SERVICING OF A DOUBLE-INSULATED APPLIANCE.  
In a double-insulated product, two systems of insulation are provided instead of grounding. No grounding means are provided for a double-insulated product, nor should grounding means be added to the product. Servicing a double-insulated product requires extreme care and knowledge of the system and should be done only by qualified service personnel. Replacement parts for a double-insulated product must be identical to the original parts. A double-insulated product is marked with the words "double Insulation" or "Double Insulated". Product may also be marked with symbol shown.



## SAVE THESE INSTRUCTIONS

### For Household Use Only

# OPERATING INSTRUCTIONS

## Using your Leaf Blower

**!** **WARNING:** If any parts are missing, damaged or broken, **DO NOT** operate the leaf trimmer until they have been replaced. Failure to do so could result in possible serious injury.

**!** **WARNING:** To prevent serious personal injury, always use both the front hand grip and the top handle to hold the leaf blower during operation.

**!** **WARNING:** To prevent serious personal injury, keep hands away from the impeller. **DO NOT** attempt to convert the leaf blower or maintain blower until all parts stop moving. Make sure that the unit is unplugged when clearing jammed material from impeller. **DO NOT** grasp the impeller when picking up or holding the unit.

**!** **WARNING:** Always inspect area to be cleared ensuring there are no large hard objects that can cause serious injury.

**!** **WARNING:** Do not attempt to vacuum water or other liquids or wet objects such as wet leaves. This could cause damage to the unit or cause electrical shock.

**!** **DANGER:** Never vacuum very hard objects such as nails, bolts, and rocks as this will severely damage the unit. Hard objects can be propelled through the debris collector bag or the housing and become dangerous missiles which can cause serious injury to operator, bystanders, or nearby solid objects. Avoid burning debris that can cause the collector bag to catch on fire. Do not operate near an open flame. Do not vacuum up discarded cigarettes, cigars, or embers from fireplace, pits or BBQ's.

**!** **WARNING:** Do not assemble or disassemble the vacuum tube or blower tube while the unit is running. Inserting or removing the vacuum tube or blower tube while unit is running can result in seriously injury. Allow unit to stop and disconnect from power source.

**!** **WARNING:** Do not use leaf blower as a vacuum without vacuum tubes and debris collector bag in place and firmly attached. Always make sure the collector bag's zipper is properly zipped before starting the unit.

Your leaf blower can be used to sweep debris or grass clippings from driveways, sidewalks, or patios. Blowing grass clippings, straw or leaves into piles for easy clean-up and/or composting.

1. Ensure that proper clothing is worn and safety glasses are used. (Fig.19)
2. Direct air flow by directing the blower tube downwards or from side to side in a sweeping motion.
3. To clean corners, work from tightest point outwards.
4. Use caution when working around vegetation as the air force could damage plant life.

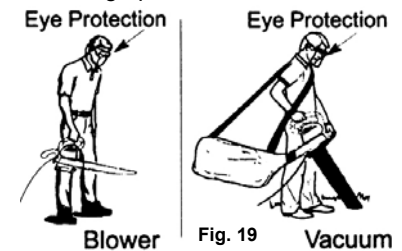

## Using your Leaf Blower as a Vacuum

Your leaf blower can be used as a vacuum to pick up dry material such as leaves, grass, small twigs, sawdust or bits of paper.

**DO NOT** use to vacuum up stones, gravel, metal, broken glass etc, as this could cause damage to impeller, or the operator and bystanders if these objects propelled through the bag.

1. Ensure that proper clothing is worn and safety. glasses are used.
2. Operated the unit at high speed for best vacuuming results.
3. Move slowly back and forth over the material you are vacuuming. Avoid forcing the unit into a pile of debris as this can block the unit or tubes.
4. Allow tube to remain at least one inch above ground for the best results.

## OPERATING INSTRUCTIONS

- Slide blower tube onto air outlet. (Fig. 11)

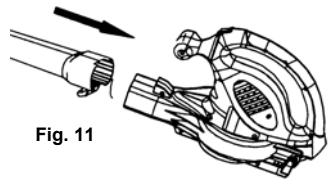

- Attach hook on blower to bar on air inlet cover. (Fig. 12)

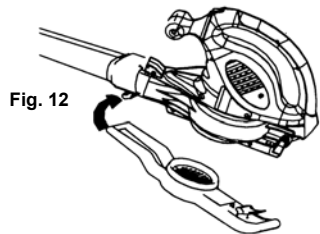

- Lift up handle on air inlet cover to engage locking tab. (Fig. 13)

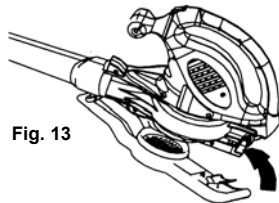

**IMPORTANT:** The leaf blower will not run unless the vacuum tube is locked in place.

### How to Use the Power Switch

**⚠ WARNING:** If you do not fully seat the extension cord on the inlet plug, the loose plug could lead to overheating and cause a fire, or electrical shock. Ensure that you fully seat the cord on the plug and use the cord lock feature to secure the cord.

**IMPORTANT:** Check the power cord frequently during use for holes in the insulation or other damage. **DO NOT** use a damaged cord.

**DO NOT** run the cord through standing water or wet grass.

- The switch has three (3) power settings. 'O' is OFF. 'I' is for low air power or low suction power. "II" is for the highest air power or suction power. See Fig. 14 for power speeds.
- Always use high power for vacuum feature of leaf blower to ensure best results.

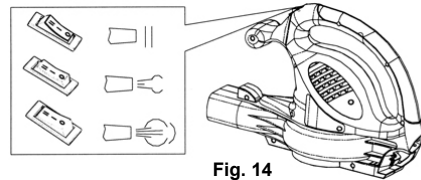

### How to Attach the Extension Cord

**NOTE: DO NOT** use an extension cord over 150 feet long.

- Use only with a 2 conductor extension cord intended for outdoor use with a polarized plug, with one blade larger than other, UL listed.
- Form a loop with the extension cord. (Fig 15)



- Slip loop through power cord guide. (Fig 16)

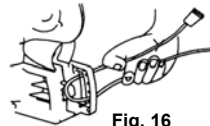

- Latch loop of power cord onto hook. (Fig. 17)

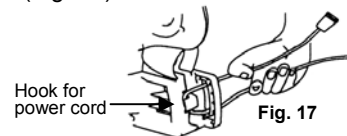

- Plug extension cord into outlet on back of unit. (Fig. 18)

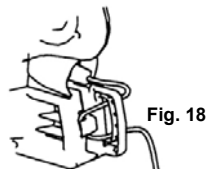

## GETTING TO KNOW YOUR LEAF BLOWER

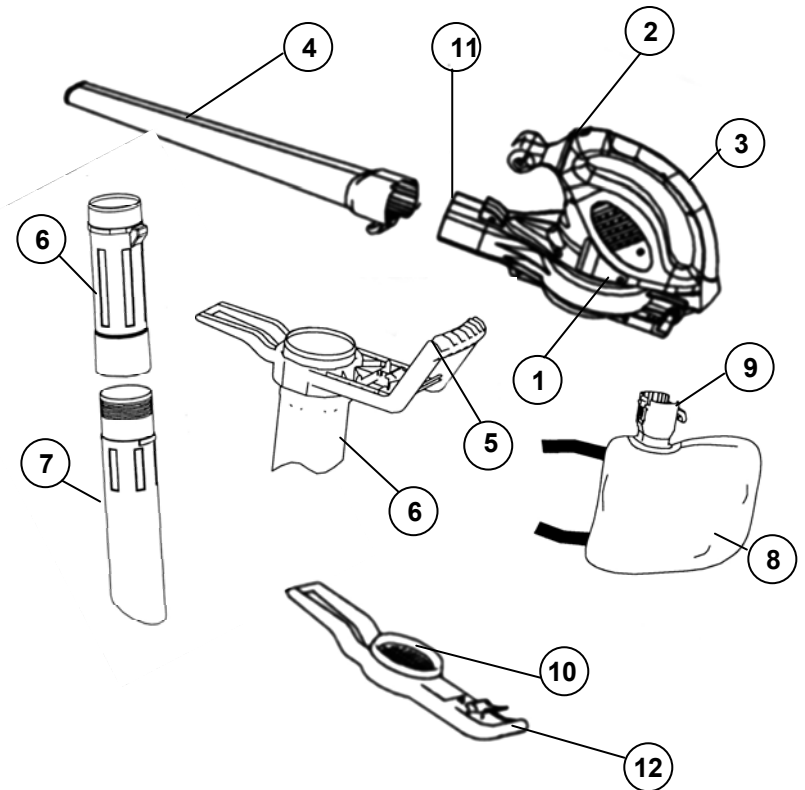

- |                            |                                 |
|----------------------------|---------------------------------|
| 1. Power Unit              | 7. Lower Vacuum Tube            |
| 2. On/Off, Speed Control   | 8. Debris Collector Bag         |
| 3. Handle                  | 9. Debris Collector Bag Adapter |
| 4. Blower Tub              | 10. Air Inlet Cover             |
| 5. Vacuum Easy Grip Handle | 11. Blower Outlet               |
| 6. Upper Vacuum Tube       | 12. Air Inlet Cover Handle      |

Illustrations may differ from actual product.

### Technical Specifications

Voltage: 120V., 60Hz.  
 Current: 12 Amps.  
 Sound pressure level (dB): ≤ 92  
 Sound power level Lwa (dB(A)): ≤ 105

**Use of ear protection is recommended when using this unit.**

## OPERATING INSTRUCTIONS

### Assembly of Blower

**WARNING:** Remove the plug from the power source before assembly of leaf blower. This will help prevent accidental starting of the unit which could result in serious injury.

**CAUTION:** The impeller rotates for a few seconds after you turn off the blower and will cause injury. **WAIT** until all parts stop moving.

**WARNING:** Do not remove the bottom inlet cover when the motor is running or when the unit is plugged into power outlet.

**NOTE:** Instructions must be followed in order.

1. Ensure unit is unplugged and all parts have stopped moving.
2. Slide blower tube onto the blower outlet (Fig. 1)

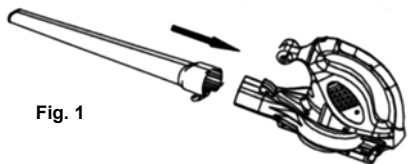

Fig. 1

**NOTE:** You must install the blower tube before installing the inlet cover because the inlet cover hooks onto the blower tube.

3. Attach inlet cover onto hook on blower tube. (Fig. 2)

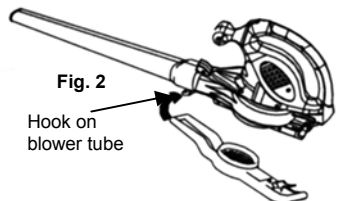

Fig. 2

4. Lift handle to lock inlet cover into place at rear of motor. (Fig.3)

**IMPORTANT:** The blower will not run unless the bottom inlet cover is locked

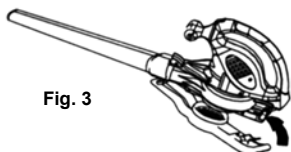

Fig. 3

### Assembly of Vacuum

**WARNING:** Remove the plug from the power source before assembly of vacuum. This will help prevent accidental starting of the unit which could result in serious injury.

**WARNING:** Do not remove the bottom inlet cover when the motor is running or when the unit is plugged into power outlet

**CAUTION:** The impeller rotates for a few seconds after you turn off the blower and will cause injury. **WAIT** until all parts stop moving.

To assemble vacuum tubes instructions must be followed in order:

1. Align tabs on upper and lower vacuum tube ensuring that the guide is also aligned. Forcefully slide lower vacuum tube onto upper vacuum tube until upper tube is at end of lower tube. Once in place these tubes are permanently attached.

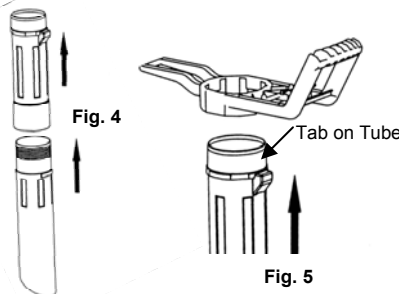

Fig. 4

Fig. 5

2. Push easy grip handle into place on upper tube. (Fig. 5)

**NOTE:** This is a permanently assembly, there is no reason to take apart after assembled.

3. Align notch on easy grip handle with tabs on upper tube.

## OPERATING INSTRUCTIONS

### Attaching Vacuum to Motor

**WARNING:** Remove the plug from the power source before assembly of leaf blower. This will help prevent accidental starting of the unit which could result in serious injury.

Attach collector debris bag to Motor when you wish to use unit as a vacuum. Once the tubes and easy grip handle have been attached you can proceed to attach bag to blower outlet.

1. Loosen velcro strap on debris collector bag.
2. Place narrow end of adapter into debris collector bag. There is enough space for collar of bag to sit above ridge created for bag cuff.
3. Pull velcro strap to tighten cuff on adapter. Ensure that bag is properly attached to avoid debris from being thrown out of opening. (Fig. 6)

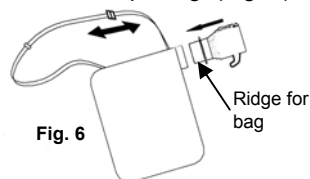

Fig. 6

4. Align locking tab with motor's locking tab holder and slide onto blower outlet until you hear a click. (Fig 7)

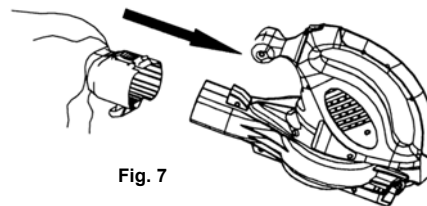

Fig. 7

**NOTE:** The strap on the bag is adjustable for comfort of use. It is suggested that you place strap across your chest. Attach Vacuum to Motor when you wish to use unit as a vacuum.

**NOTE:** Only use vacuum to pick up small dry debris such as: grass clippings, dry leaves, or small twigs.

**DO NOT** vacuum up glass, pebbles, gravel, or large sticks.

**IMPORTANT:** The vacuum will not run unless the vacuum tube is locked in place.

**NOTE:** Bag adapter must be in position before vacuum tubes can be attached.

5. Angle motor to allow hook on bag adapter to securely hook onto last bar of easy grip handle.
6. Lift easy grip handle to secure locking tab in place. (Fig. 8)

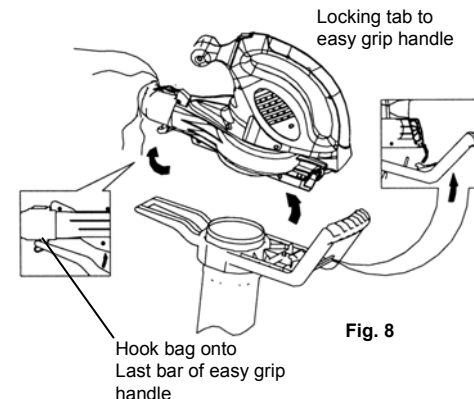

Fig. 8

### Converting Your Unit From Vacuum to Blower

1. Unplug unit and ensure all parts stop moving.
2. Press on locking tab near handle to remove easy grip handle from motor. Angle motor to release hook from locking bar. (Fig. 9)

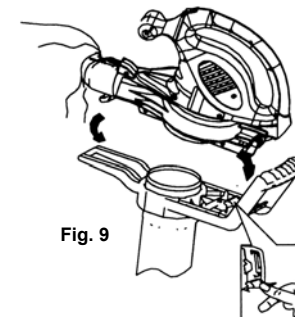

Fig. 9

3. Press on locking tab to remove bag adapter from unit. (Fig. 10)

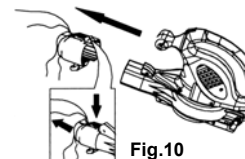

Fig. 10



## Free Manuals Download Website

<http://myh66.com>

<http://usermanuals.us>

<http://www.somanuals.com>

<http://www.4manuals.cc>

<http://www.manual-lib.com>

<http://www.404manual.com>

<http://www.luxmanual.com>

<http://aubethermostatmanual.com>

Golf course search by state

<http://golfingnear.com>

Email search by domain

<http://emailbydomain.com>

Auto manuals search

<http://auto.somanuals.com>

TV manuals search

<http://tv.somanuals.com>