

FANTOM®

Deluxe
1450^{psi} Pressure Washer

OWNER'S MANUAL

Model VPW43H

120V., 60 Hz., 12.5 Amps.



For information or assistance:

FANTOM

178 West Service Rd.
Champlain, NY 12919
Tel.: 1-800-798-7398

SAFETY & WARNING INSTRUCTIONS

For safety reasons, it is recommended that you read this manual before attempting to operate this appliance. Failure to follow these instructions can result in personal injury or equipment problems. To help recognize note the following symbols:



Danger indicates an imminently hazardous situation, which, if not avoided, **WILL** result in death or serious injury.



Warning indicates a potentially hazardous situation, which, if not avoided, **COULD** result in death or serious injury.



Caution indicates a potentially hazardous situation, which, if not avoided, **MAY** result in death or serious injury.

NOTE: Information that requires special attention.

Important Safety Instructions SAVE THESE INSTRUCTIONS

When using this product, basic precautions should always be followed, including the following:



1. Read all instructions before using the product.
2. To reduce the risk of injury, close supervision is necessary when this product is used near children.
3. Always disconnect power (electric units) before disassembling, repairing or changing attachments on the unit.
4. Follow all safety codes as well as the Occupational Safety and Health Act (OSHA).
5. Ensure safety devices are operating properly before each use. DO NOT remove or modify any part of the gun or unit.
6. Know how to stop this unit and relieve pressure quickly. Be thoroughly familiar with the controls.
7. Stay alert - Watch what you are doing.
8. Do not operate this unit when fatigued or under the influence of alcohol or drugs.

9. Keep operation area clear of all persons.
10. Do not overreach or stand on unstable support. Keep good footing and balance at all times.
11. Follow maintenance instructions specified in this manual.
12. This product shall be connected to a power supply receptacle protected by a ground fault circuit interrupter (GFCI) (electric power washers only).
13. If product is provided with a GFCI, be sure to inspect the cord and GFCI prior to use. Any repair or replacement of the power cord must be performed by a qualified (licensed or certified) electrical technician.



Risk of injection or severe injury. Keep clear of nozzle. Do not discharge streams at persons. This product is to be used only by trained operators. Always remove lance from gun before cleaning debris from tip.

- Keep clear of nozzle. **NEVER** direct high pressure spray at any person, animal or self.
- Always wear safety goggles or glasses and protective clothing when operating, performing maintenance or changing accessories.
- **Never** put hands or fingers over the spray tip while operating the unit.
- **Never** try to stop or deflect leaks with any body part.
- Always engage the trigger safety latch in the safe position when spraying is stopped even if only for a few minutes.
- Always follow detergent manufacturer's label recommendations for proper use of detergents. Always protect eyes, skin and respiratory system from detergent use.



SERVICING OF A DOUBLE-INSULATED APPLIANCE.
In a double-insulated product, two systems of insulation are provided instead of grounding. No grounding means are provided for a double-insulated product, nor should grounding means be added to the product. Servicing a double-insulated product requires extreme care and knowledge of the system and should be done only by qualified service personnel. Replacement parts for a double-insulated product must be identical to the original parts. A double-insulated product is marked with the words "double Insulation" or "Double Insulated". Product may also be marked with symbol shown.



Model VPW43H



THREE (3) YEAR LIMITED WARRANTY

FANTOM warrants this product to be free from defects in material and workmanship for a period of three (3) years from the date of the original purchase, when utilized for normal household use, subject to the following conditions, exclusions and exceptions.

If your appliance fails to operate properly while in use under normal household conditions within the warranty period, return the complete appliance and accessories, freight prepaid to FANTOM, 178 W. Service Rd. Champlain, NY 12919. If the appliance is found by **FANTOM** to be defective in material or workmanship, **FANTOM** will repair or replace it free of charge. Proof of purchase date and \$ 16.95 to cover the cost of return shipping and handling must be included. *

Non-durable parts including, without limitation, hoses, lances, brushes and electrical parts which normally require replacement are specifically excluded from warranty.

The liability of **FANTOM** is limited solely to the cost of the repair or replacement of the unit at our option. This warranty does not cover normal wear of parts and does not apply to any unit that has been tampered with or used for commercial purposes. This limited warranty does not cover damage caused by misuse, abuse, negligent handling or damage due to faulty packaging or mishandling in transit. This warranty does not cover damage or defects caused by or resulting from damages from shipping or repairs, service or alterations to the product or any of its parts, which have been performed by a repair person not authorized by **FANTOM**.

This warranty is extended to the original purchaser of the unit and excludes all other legal and/or conventional warranties. The responsibility of **FANTOM** if any, is limited to the specific obligations expressly assumed by it under the terms of the limited warranty. **In no event is FANTOM** liable for incidental or consequential damages of any nature whatsoever. Some states do not permit the exclusion or limitation of incidental or consequential damages, so the above may not apply to you.

This warranty gives you specific legal rights, and you may also have other rights which vary from state to state.

***Important: Carefully pack item to avoid damage in shipping. Be sure to include proof of purchase date and to attach tag to item before packing with your name, complete address and phone number with a note giving purchase information, model number and what you believe is the problem with item. We recommend you insure the package (as damage in shipping is not covered by your warranty). Mark the outside of your package "ATTENTION CUSTOMER SERVICE". We are constantly striving to improve our products, therefore the specifications contained herein are subject to change without notice.**



OWNERSHIP REGISTRATION CARD

Please fill out and mail the product registration card within ten (10) days of purchase in order to validate the foregoing Limited Warranty. The registration will enable us to contact you in the unlikely event of a product safety notification. By returning this card you acknowledge to have read and understood the instructions for use, and warnings set forth in the accompanying instructions.

RETURN TO FANTOM: 178 W. Service Rd. Champlain, NY 12919

Model VPW43H

Appliance model

Date purchased _____ **Name of store** _____

Owner's name _____

Address _____ **City** _____ **State** _____ **Zip Code** _____

Printed in Italy

TROUBLE SHOOTING

PROBLEM	POSSIBLE REASON	POSSIBLE SOLUTION
PRESSURE WASHER WILL NOT START WHEN THE ON/OFF SWITCH IS IN THE "ON" POSITION	<ol style="list-style-type: none"> Electrical socket is faulty or breaker has tripped. Voltage is inadequate. GFCI has tripped. Power cord is not plugged in. 	<ol style="list-style-type: none"> Check plug, socket, fuses, breaker. Check that the voltage is adequate. Reset/Try another electrical outlet. Plug in power cord.
PUMP DOESN'T REACH ADEQUATE PRESSURE OR CAVITATES	<ol style="list-style-type: none"> Water intake filter is clogged. Pump is drawing air. Diameter of garden hose is too small. Water supply is restricted. 	<ol style="list-style-type: none"> Remove and clean water intake filter. Tighten connections/bleed system. Replace with 3/4 inch garden hose. Check hose for kinks or leaks, open tap fully.
PRESSURE WASHER HAS OR WILL NOT MAINTAIN PRESSURE	<ol style="list-style-type: none"> Excessive air in waterline and pump. Water supply is restricted. 	<ol style="list-style-type: none"> Turn unit and water supply off/Bleed system/Hold trigger down. Allow water to flow through the pump for 30 seconds. Check hose for kinks or leaks, open tap fully.
PRESSURE WASHER MAKES EXCESSIVE NOISE	<ol style="list-style-type: none"> Air intake is blocked. Water intake filter is dirty. 	<ol style="list-style-type: none"> Clean the air intake vents. Check & clean filter.
MOTOR DOES NOT RUN CONTINUOUSLY WHEN TRIGGER IS SQUEEZED/ MOTOR BUZZES WHEN TURNED ON BUT DOES NOT START/MOTOR STOPS RUNNING WHILE UNIT IS IN USE	<ol style="list-style-type: none"> Net voltage is lower than suggested. 	<ol style="list-style-type: none"> Check that the voltage is adequate.

SAFETY & WARNING INSTRUCTIONS

continued

WARNING

Do not use pressure that exceeds the operating pressure of any of the parts (hoses, fittings, etc.) in the pressurized system. Ensure that all equipment and accessories are rated to withstand the maximum working pressure of the unit.

WARNING

Explosion hazard.

- NEVER** spray flammable liquids of use pressure washer in areas containing combustible dust, liquids or vapors.
- NEVER** operate this machine in a closed building or in or near an explosive environment.

WARNING

Do not spray electrical apparatus or wiring.

- NEVER** disconnect the high pressure discharge hose from the machine while the system is pressurized. To depressurize the machine, turn the power and water supply off, then press the gun trigger 2-3 times.
- NEVER** permanently engage the trigger mechanism on the gun.
- NEVER** operate the machine without all the components properly connected to the unit (handle, gun/lance assembly, nozzle, etc.).

WARNING

Equipment damage.

- ALWAYS** turn water supply "ON" before turning the pressure washer "ON". Running pump dry causes serious damage.
- Do not operate the pressure washer with the inlet water screen removed. Keep screen clear of debris and sediment.
- NEVER** operate pressure washer with broken or missing parts. Check equipment regularly and repair or replace worn or damaged parts immediately.
- Use only the nozzle supplied with this machine.
- Never leave the lance unattended while the machine is running.
- Never attempt to alter factory settings. Altering factory settings could damage the unit and will void the warranty.

- Always hold gun and lance firmly when starting and operating the machine.
- NEVER allow the unit to run with the trigger released (OFF) for more than one minute. Resulting heat buildup will damage pump.**
- NEVER** store the pressure washer outdoors or where it could freeze. The pump will be seriously damaged.
- Release trigger when changing from high to low pressure modes. Failure to do so could result to damage to the nozzle.
- This unit must always be used in the horizontal position.

CAUTION

Keep hose away from sharp objects. Bursting hose may cause injury. Examine hoses regularly and replace if damaged. Do not attempt to mend a damaged hose.

EXTENSION CORDS

DANGER

If using an extension cord, use only grounded, three wire extension cords that are in good condition. Use only extension cords that are intended for outdoor use. These extension cords are identified by a marking "Acceptable for use with outdoor appliances; store indoors while not in use." use only extension cords having an electrical rating not less than the product. Do not use damages extension cords. Examine extension cord before using and replace if damaged. Do not abuse extension cord and do not pull on the cord to disconnect. Keep cord away from heat and sharp edges. Always disconnect from the receptacle before disconnecting the product from the extension cord.
Note: Do not use 16 or 18 AWG extension cords on this product.

DANGER

Failure to follow these instructions can result in serious injury, including death.

WARNING

To reduce the risk of electrocution, keep all connections dry and off the ground. Do not touch the plug with wet hands.

Extension Cord	Allowable Length	
	25'	50"
14 AWG	YES	NO
12 AWG	YES	YES

GETTING TO KNOW YOUR PRESSURE WASHER

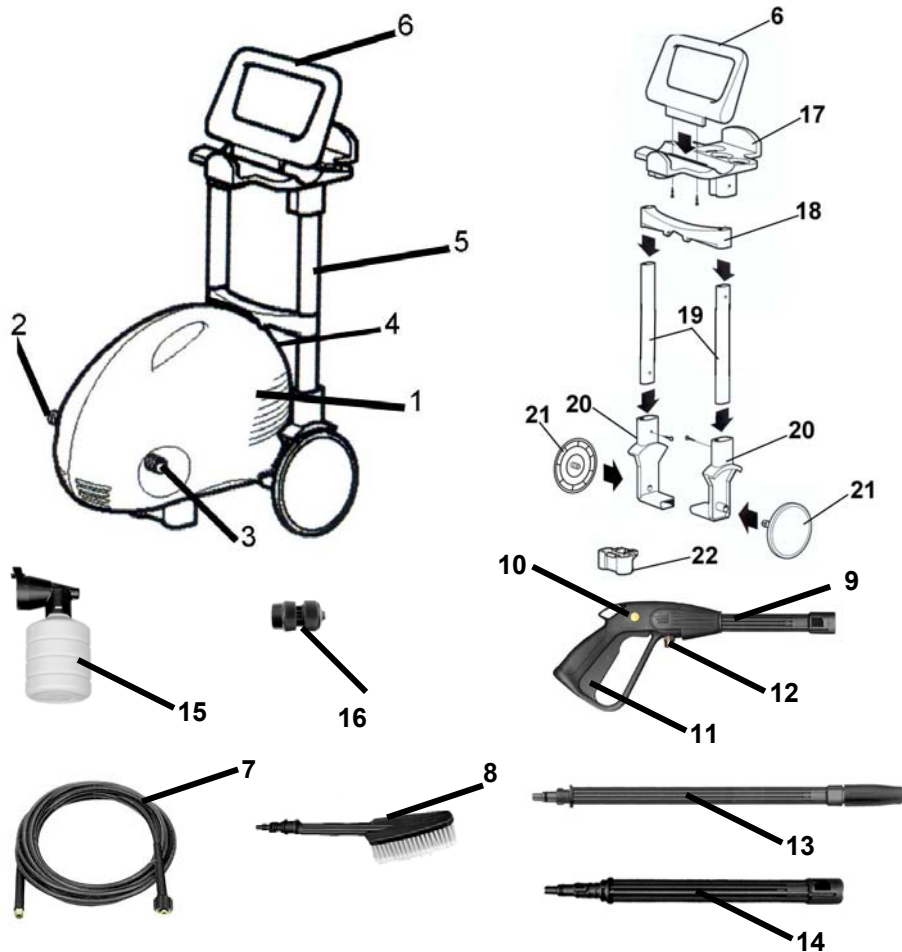

- | | |
|-------------------------|--------------------------------------|
| 1. Pressure Washer | 12. High Pressure Hose Connector |
| 2. Water Intake | 13. High Pressure Lance |
| 3. High Pressure Output | 14. Adjustable Fan Jet Lance |
| 4. On/Off Switch | 15. Detergent Applicator Bottle |
| 5. Trolley | 16. Garden Hose Coupling |
| 6. Trolley Handle | 17. Handle Bracket |
| 7. High Pressure Hose | 18. Top Brace |
| 8. Brush | 19. Legs (x2) |
| 9. Trigger Gun | 20. Support Bracket (x2) |
| 10. Safety Lock | 21. Wheel (x2) |
| 11. Trigger | 22. Front Support |
| | 23. Trolley Screws (x11) (not shown) |

Illustrations may differ from actual product.

Technical Specifications

Voltage:	120V., 60Hz.
Power:	12.5 Amps.
Pressure:	1450 psi. (max)
Flow Rate:	1.45 gpm

OPERATING INSTRUCTIONS

Storing Your Pressure Washer

When you have finished using your pressure washer, follow these steps for safe storage:

1. Turn the pressure washer to the "Off" position.
2. Turn off the water supply.
3. Before disconnecting the high pressure hose connection, point the trigger gun in a safe direction away from you and discharge the high pressure water. Disconnect the high pressure hose from the pressure washer and trigger gun.
4. Disconnect garden hose from pressure washer.
5. Remove excess water from the pump by tipping the unit on both sides to drain any remaining water from the water intake and outlet fittings.
6. Drain detergent applicator bottle and flush with clean water.
7. Wipe away any remaining water on all parts and fittings.
8. Engage the trigger gun safety lock.
9. Store the unit and accessories in a room above 32°F.

Winterizing & Long Term Storage

1. Disconnect all water connections.
2. Turn the pressure washer on for a few seconds, until any remaining water in the pump exits.
3. Turn the unit off immediately.
4. Store the pressure washer, parts and accessories in an area with a temperature above 32°F.

Motor Thermostat

Important: This pressure washer is equipped with a motor thermostat. The motor will stop if it is overheating. Wait 10-20 minutes before starting the unit again. If it stops again, please call FANTOM customer service at 1-800-798-7398.

Ground Fault Circuit

Interrupter (GFCI)

This unit is equipped with a **Ground Fault Circuit Interrupter (GFCI)** built into the plug. This device provides additional protection from the risk of electrical shock. When connecting the GFCI to the electrical outlet, the indicator should appear red. If the indicator is not red, depress the RESET button on the GFCI until the indicator appears red.

Cleaning Tips

Wood Decks: Rinse deck and surrounding area with fresh water. If using detergent, fill the detergent applicator bottle and apply to the area being cleaned. For optimal results, reduce your work area to small sections and clean each section one at a time. Allow the detergent to rest on the surface for a few minutes and then rinse at high pressure. Do not let the detergent dry on the deck. Always clean from left to right and top to bottom for best results. Rinse at high pressure using the fan jet keeping the tip of the spray nozzle 8-12 inches from the surface. **Caution:** For soft woods, increase the distance from the cleaning surface.

Cars, Boats, & Motorcycles: Wet down area to be cleaned before applying detergent with clean water. Fill the detergent applicator bottle and apply to the area being cleaned. To achieve best results, clean one side at a time. Allow the detergent to rest on the surface for a few minutes but do not let it dry. Rinse at high pressure using the fan jet in a sweeping motion keeping the tip of the spray nozzle at least 8-10 inches away from the surface. Maintain a further distance when using a direct spray. Wipe surface for a polished finish.

OPERATING INSTRUCTIONS

CAUTION

When you wish to stop using the pressure washer temporarily, make sure that the safety lock has been engaged to avoid any accidental operation. (Fig. 14)

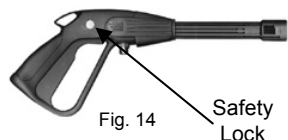

Fig. 14 Safety Lock

Using the Adjustable Fan Jet lance

The angle of the water on the fan jet lance may be adjusted between 0° and 60° by turning the nozzle adjuster counter-clockwise for a wider angle or clockwise for a narrower angle. (Fig. 15 & Fig. 16) Always make sure that the "On/Off" switch is in the "Off" position before changing the angle of the water jet. It is also recommended that the trigger gun safety lock be engaged as well. The adjustable fan jet lance allows you to use any variety of spray pattern from a full fan spray to a direct stream spray. When using the pressure washer to clean wood decks, siding vehicles, etc., always start using the fan spray and begin spraying from a minimum 36" away to avoid damaging the surface of the material that you are cleaning. Always clear the area that you will be cleaning of people, pets and objects.

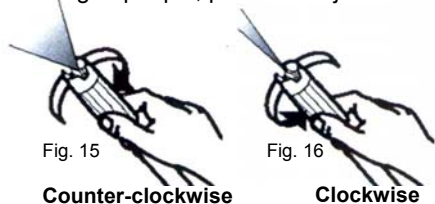

Fig. 15

Fig. 16

Counter-clockwise

Clockwise

Using the High Pressure lance

The high pressure lance may be used alone (Fig. 17) or with the detergent applicator bottle.

Add detergent to the bottle and then attach the detergent applicator bottle to the high pressure lance, just push it on the end of the high pressure lance. (Fig. 18) To remove the detergent applicator bottle, lift the tab on the top of the connector and pull off.



Fig. 17



Fig. 18

Using the Brush With the Trigger Gun

The brush is used with the trigger gun. Push the brush onto the trigger gun nozzle and turn clockwise to lock as you would for the lances. (Fig. 19) the brush may be used for washing cars, boats, windows and other similar items. The brush operates at open orifice pressure so it will not direct a stream of water.

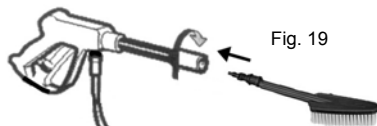

Fig. 19

Maintenance & Cleaning

Lubrication: The pressure washer is supplied with a closed lubrication system, so no addition of oil is needed.

Checking the Water Intake Filter: The water intake filter is located inside the water intake connector. (Fig. 20). Remove periodically and inspect for any deposits that might accumulate there.

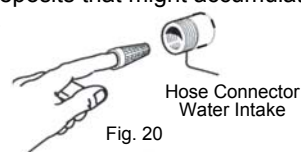

Fig. 20

Cleaning the Nozzles: If you notice that the output pressure fluctuates, you may have to clean the nozzles. Turn the unit "Off". Unplug from electric outlet and disconnect the water supply. Remove the lances, trigger gun and hose from unit. Take the small metal pin provided and insert into the nozzle end to remove any obstructions. (Fig. 21)



Fig. 21

This will occur more frequently if your water supply is very hard.

OPERATING INSTRUCTIONS

Suitable Use of Your Pressure Washer

This high pressure washer is suitable for non-professional use. The working temperature must range between 40°F and 120 °F. The machine is supplied with a trigger gun, equipped with a trigger handle to offer a comfortable working position.

The high pressure washer is suitable for washing with cold water only. The water that you use for the pressure washer must not be dirty, sandy or contain any corrosive chemical products.

The pressure washer may be used to wash shutters, doors, tiles, cars, decks, campers, etc., where high water pressure is necessary to remove dirt.

With the detergent applicator bottle, the pressure washer can be used to apply a thick coating of aerated detergent to the areas being cleaned.

When using the pressure washer we recommend the use of personal safety items to reduce the risk of accidental injury.

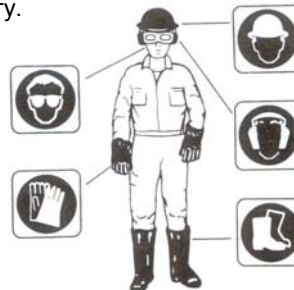

Unpacking Your Pressure Washer

After you open the package, check to make sure that all the parts are in the box as pre parts that illustrated on page 3 of this guide. Due to transport and packing restraints, some accessories may be supplied unassembled; in this case follow the assembly instructions in this manual. If you have any questions, call FANTOM customer service at 1-800-798-7398. Keep all small and potentially harmful parts of the package (plastic bags, foamed polystyrene, nails, etc.) out of the reach of children.

Correct Use of the Pressure Washer

- Place the pressure washer in a safe area and on a horizontal surface.
- When using the pressure washer, hold the trigger gun firmly with one hand on the handle and the other on the lance. (Fig. 1)



Fig. 1

- NEVER** point the water jet at electric wiring, at the pump unit, or at any person or animal.

Assembling the Pressure Washer Trolley

- Carefully take all the trolley parts and place together on a flat, stable surface.
- Insert the two (2) legs into the support brackets and secure with the two (2) screws provided. (Fig. 2)

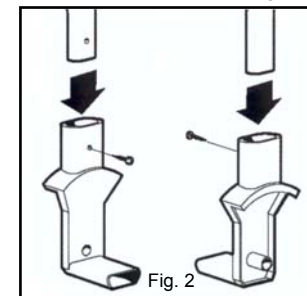

Fig. 2

- Place the pressure washer between the two support brackets and secure with the two (2) screws provided. (Fig. 3)

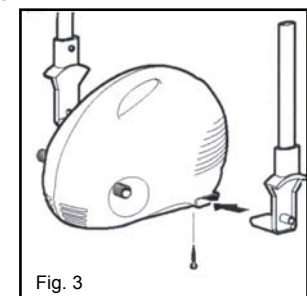

Fig. 3

OPERATING INSTRUCTIONS

Assembling the Pressure Washer Trolley (cont)

4. Insert the handle into the handle bracket and secure with the two (2) screws provided. (Fig. 4)

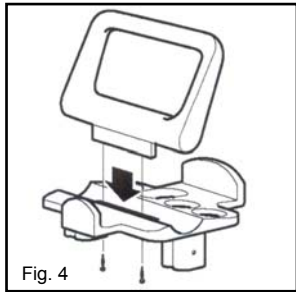

Fig. 4

5. Slide the top brace over the legs and insert the handle assembly onto the top of the legs. Secure the handle assembly to the legs with the two (2) screws provided. (Fig. 5)

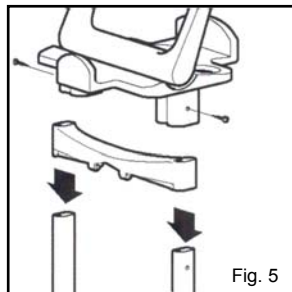

Fig. 5

6. Slide the top brace down the legs until it reaches the top of the pressure washer. Secure the top brace to the pressure washer unit with the two (2) screws provided. (Fig. 6)



Fig. 6

7. To attach the wheels to the support brackets, just push them in until they lock in place. (Fig. 7)

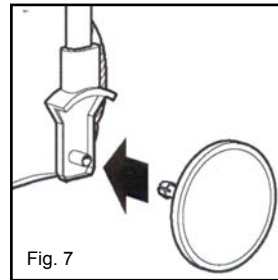

Fig. 7

8. To attach the front support to the pressure washer unit, place it under the front of the unit in the mark provided. Push it in until it snaps into place. Then secure it to the pressure washer with the screw (1) provided. (Fig. 8)

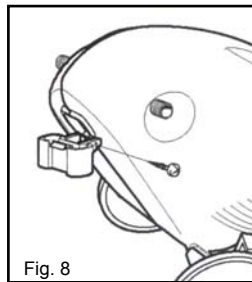

Fig. 8

9. When the unit is finally assembled, it should look like the illustration below. (Fig. 9)

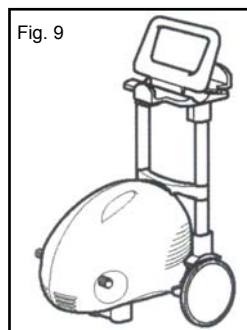

Fig. 9

OPERATING INSTRUCTIONS

Attaching High Pressure Hose to Pressure Washer

Once the pressure washer is assembled to the trolley, you are ready to use the unit.

1. While facing the front side of the unit attach the high pressure hose to the high pressure output connector on the right side of the unit. Twist on tight to avoid leakage. (Fig. 10)

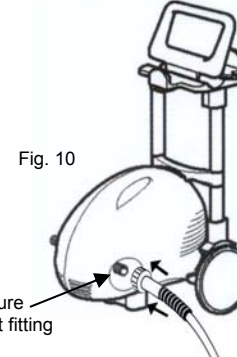

Fig. 10

2. Then attach the other end of the high pressure hose to the high pressure hose connector on the trigger gun. (Fig. 11)



Fig. 11

3. Once the high pressure hose is connected to the trigger gun, you can attach any of the lances and accessories that you desire. To attach either of the lances or the brush to the trigger gun, hold the trigger gun in your left hand insert the desired lance or the brush and push it in all the way into the connector on the trigger gun and turn it clockwise 60° until it locks in place. To remove the attachment, push down on the attachment and turn counter-clockwise 60° and then pull out. Make sure that the attachments are securely locked in place before use. (Fig. 12)

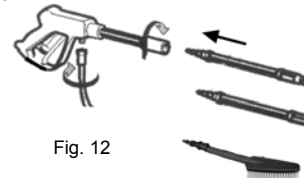

Fig. 12

Garden Hose Connection

Once all the desired attachments and the high pressure hose are attached to the pressure washer, you can connect the garden hose to the unit.

1. Attach the male adapter (supplied) to the water intake connector on the left hand side of the unit. (Fig. 13)
2. Attach the female hose coupling to the garden hose. (Fig. 13)
3. Connect the female hose coupling to the male adapter making sure that it is tightly secured in place. (Fig. 13)

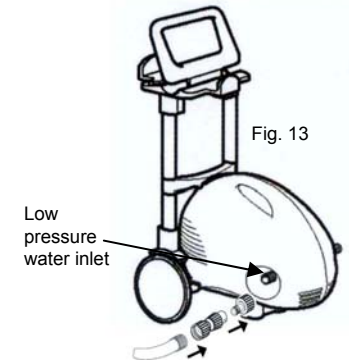

Fig. 13

4. After all the connections have been made and **BEFORE** you plug the pressure washer into an electrical outlet, open the water supply and press on the trigger switch in order to remove any air which may be in the hose or pump. Continue to press on the trigger switch until you get a constant flow of water coming out of the trigger gun. Allow water to flow for 30 seconds.
5. Once this is accomplished, stop pressing the trigger switch. Engage the safety lock on the trigger
6. Ensure that the "On/Off" switch, at the rear of the unit, is on the "Off" position, then plug the unit into an electrical outlet and turn the unit to the "On" position.
7. Now you are ready to use the pressure washer. Disengage the safety lock and depress the trigger on the trigger gun.

Free Manuals Download Website

<http://myh66.com>

<http://usermanuals.us>

<http://www.somanuals.com>

<http://www.4manuals.cc>

<http://www.manual-lib.com>

<http://www.404manual.com>

<http://www.luxmanual.com>

<http://aubethermostatmanual.com>

Golf course search by state

<http://golfingnear.com>

Email search by domain

<http://emailbydomain.com>

Auto manuals search

<http://auto.somanuals.com>

TV manuals search

<http://tv.somanuals.com>