

Fahrenheit
MULTI MEDIA DISC PLAYER
Model : DVD-16TM

Before attempting to connect,
or operating this product,
please read the manual completely

OWNER'S MANUAL

TABLE OF CONTENTS

1. Precautions	3
2. Safety Precautions	4
3. About This OWNER'S MANUAL	6
4. About DVD	7
5. Identification of Controls	
5-1. Main body(front part)	8
5-2. OPERATING STATUS display	8
5-3. Main Body(rear part)	9
5-4. Accessories	9
5-5. Remote Control	10
6. Connecting to System	
6-1. Connecting to TV/Monitor	11
6-2. Connecting to TV/Audio system	12
6-3. Connecting to an AMP supporting Dolby Pro Logic	13
6-4. Connecting to an AMP supporting Dolby Digital	14
6-5. Connecting to the other devices	15
7. DVD Player Operations	16
8. Function Buttons...	
8-1. Screen Display	17
8-2. P/N(Setting of TV receiving method)	17
8-3. PBC FUNCTION	18
8-4. RANDOM FUNCTION	18
8-5. Track(Selecting audio language)	18
8-6. Angle(Selecting watch angle)	18
8-7. Subtitle(Selecting subtitle language)	19
8-8. PROGRAM	19
8-9. ►, ◀, ▲, ▼ (Moving to various directions)	19
8-10. Number button	19
8-11. GOTO(Selecting the location to play)	20
8-12. A-B (Playing between two specific points)	20
8-13. REPEAT(Repeat setup)	20
8-14. ZOOM(Screen zoom-in or zoom-out)	21
8-15. VOLUME(Adjusting volume/key)	21
8-16. MUTE(No sound)	21
8-17. PLAY/STOP	21
8-18. PAUSE	22
8-19. FWD/BWD(Forward/Backward search)	22
8-20. STEP(Still picture)	22
8-21. SLOW	22
9. SETUP	
9-1. GENERAL SETUP	24
9-2. AUDIO SETUP	26
9-3. DOLBY DIGITAL SETUP	26
9-4. PREFERENCES	27
10. Other Functions	
10-1. LAST SCENE MEMORY Function(Optional)	29
10-2. MP3 Disc Operations	29
11. How to install mounting Bracket	30
12. Specifications	31

1. Precautions



TO REDUCE THE RISK OF ELECTRIC SHOCK, DO NOT REMOVE THE COVER (OR BACK). NO USER-SERVICEABLE PARTS ARE INSIDE. REFER SERVICING TO QUALIFIED SERVICE PERSONNEL.



This symbol indicates "dangerous voltage" inside the product that presents a risk of electric shock or personal injury



This symbol indicates important instructions accompanying the product

CAUTION : THIS UNIT HAS BEEN ADAPTED WITH AN INVISIBLE CLASS 1 LASER BEAM WHICH CAN CAUSE HAZARDOUS RADIATION EXPOSURE IF DIRECTED. BE SURE TO OPERATE THE UNIT CORRECTLY AS INSTRUCTED.

Cautions

Caution: To prevent electric shock, match wide blade of plug to wide slot, fully insert.

Attention: Pour éviter les chocs électriques, introduire la lame la plus large de la fiche dans la borne correspondante de la prise et pousser jusqu'au fond.

This product satisfies FCC regulations when shielded cables and connectors are used to connect the unit to other equipment. To prevent electromagnetic interference with electric appliances, such as radios and televisions, use shielded cables and connectors for connections.

FCC NOTE (for U.S.A.):

This equipment has been tested and found to comply with the limits for a Class B digital device, pursuant to Part 15 of the FCC rules. These limits are designed to provide reasonable protection against harmful interference in a residential installation. This equipment generates, uses and can radiate radio frequency energy and, if not installed and used in accordance with the instructions, may cause harmful interference to radio or television reception, which can be determined by turning the equipment off and on, the user is encouraged to try to correct the interference by one or more of the following measures.

- Reorient or relocate the receiving antenna.
- Increase the separation between the equipment and receiver.
- Connect this equipment into an outlet on a circuit different from that to which the receiver is connected.
- Consult the dealer or an experienced radio/TV technician for help. This class B digital apparatus meets all requirements of the Canadian Interference -- Causing Equipment Regulations

CLASS 1 LASER PRODUCT
KLASSE 1 LASER PRODUKT
LUOKAN 1 LASER LAITE
KLASS 1 LASER APPARAT

WARNING

To reduce the risk of fire or shock hazard, do not expose this DVD player to rain or moisture.

CAUTION

THIS PRODUCT UTILIZES A LASER. USE OF CONTROLS OR ADJUSTMENTS OR PERFORMANCE OF PROCEDURES OTHER THAN THOSE SPECIFIED HEREIN MAY RESULT IN HAZARDOUS RADIATION EXPOSURE. DO NOT OPEN COVER AND DO NOT REPAIR YOURSELF. REFER SERVICING TO QUALIFIED PERSONNEL.

2. Safety Precautions

1. Before Operating Your Unit

Make sure that your power supply is of the type indicated on a sticker on the body of this unit. Install this unit (in a well ventilated place with at least 7cm on the top and 10cm on the left, right, and at the back of this unit). Do not obstruct the ventilation holes. Do not place any objects on the top of this unit. Do not place other appliance (including amplifiers) that produce heat on the top of this unit. Be sure to remove the disc when moving this unit. This unit is designed for continuous use. The power plug should be unplugged from the outlet when left unused for a long period of time.

2. Caution

Install this unit away from moisture, heat sources, and places exposed to strong magnetic or electric fields. Disconnect the power cable from the main electricity supply when the unit malfunctions. Your DVD player is intended not for industrial use, but for domestic use only. This product is for personal use only. When condensation forms inside the player or on the surface of the disc due to sudden temperature changes from cold to hot, the player may not operate correctly. If this occurs, leave the player at room temperature for about 2 hours or until the player becomes operational.

This unit is designed for DC12V and 3A (minimum). For home use, buy a AC adaptor (DC12V/3A—minimum) at a electronics store. AC adaptor is not supplied in accessories.

Do enjoy it as far as a car is parked and stopped for a long time. (Do not enjoy it while you're driving because it is dangerous).

3. Warning

Never disassemble the main unit in any way. This is harmful to body as well as to your DVD player. Electric shock or exposure to an invisible laser beam may result. Do not look inside the DVD player as this is hazardous to your eyes.

4. Batteries

The batteries used in the remote control contain the chemical that are harmful to the environment. Do not dispose of batteries in the general household waste.

5. Handling the Main Unit

For safety reasons,

- Do not benzene or other solvents when cleaning.
- Wipe the main unit with a soft cloth.

1

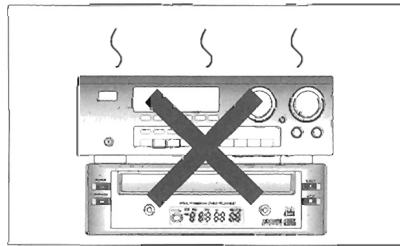
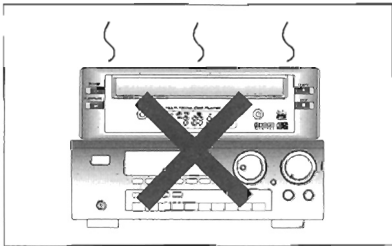
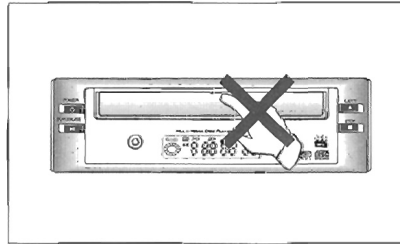
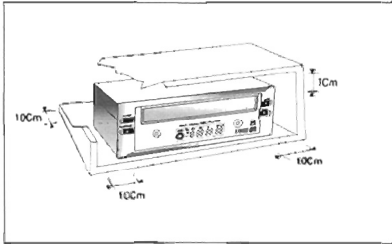

2

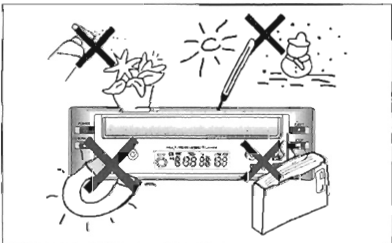

3



4

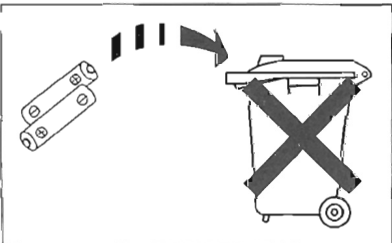

5

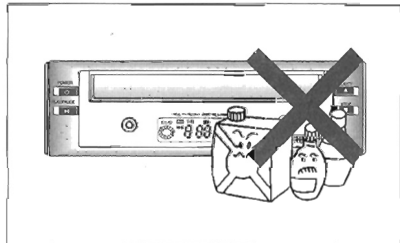

3. About This OWNER'S MANUAL

- This OWNER'S MANUAL deals with basic operation details for this unit.
- Subject to DVD video disc type, some using methods are not described in this manual or are different with this manual.
- At this time, please see and follow instructions displayed in the TV screen.
- For using this player, 'MP' mark can be displayed in the TV screen. This mark means some discs do not operate in this player.

Region Number

Region Number	Region (Deleted as appropriate)
1	North America such as U.S., Canada
2	Japan, Europe(except East Europe), Middle East, South Africa
3	Korea and Southeast Asia
4	Oceania such as Australia, New Zealand, Central and South America
5	India, East Europe, Africa
6	China
ALL	All countries

DVD players and DVD discs are marked for the Region number to be displayed in the relevant country as shown in the above table.

Playable Discs in this DVD player



Manufactured under license from Dolby Laboratories. "Dolby", "Pro Logic", and the double-D symbol are trademarks of Dolby Laboratories.

This product incorporates copyright protection technology that is protected by method Claims of certain U.S. patents and other intellectual property rights owned by Macrovision Corporation and other rights owners. Use of this copyright protection technology must be Authorized by Macrovision Corporation, and is intended for home and other limited viewing uses only unless otherwise authorized by Macrovision Corporation. Reverse engineering or disassembly is prohibited.

4. About DVD

Portable DVD Player

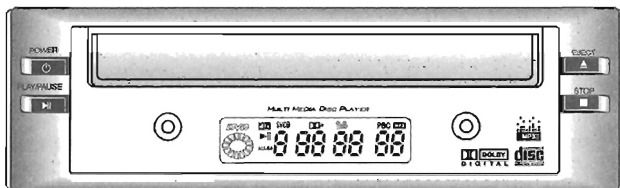

Like existing Video Player, you can easily use this product by connecting to TV/Monitor as a multimedia device. As a hi-tech digital device playing 120 minutes or more of films and musics as well as DVD DISC, Video / Audio CD, MP3 and 12cm/8cm Disc, you can enjoy its high quality of sound and definition at your home as well as in your car as you feel in a theater.

Merits of DVD

- **Dolby Digital**

You may enjoy high quality multichannel sound reproduction when you connect this product to a Dolby Digital receiver.

- **High definition**

Clear image to be played with 10 bits video D/A converter.

- **High quality of sound**

Signal regeneration of 96KHz/24bit PCM mode is excellent for matchless quality of DVD standard.

- **DTS(Digital Theater System)**

You can enjoy high-quality digital surround sound by connecting this product to DTS decoder or any Amp equipped with it.

- **Multi audio**

Audio sound track supports maximum 8 languages(different by titles).

- **Multi captions**

Maximum 32 language captions can be supported(different by titles).

- **Multi angles**

You can see screens photographed from 9 different angles(only for a title photographed from multi angles).

- **Protection of your children**

It prohibits children or juveniles from playing adult, sexy or violent materials.

Caution

Laser is applied in this product, so be careful in disintegrating or remodeling, or repairing this product so that you not be damaged by the laser.

5. Identification of Controls

5-1. Main body (front part)

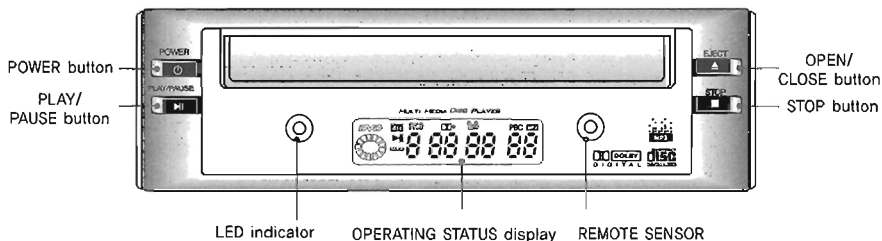

5-2. OPERATING STATUS display

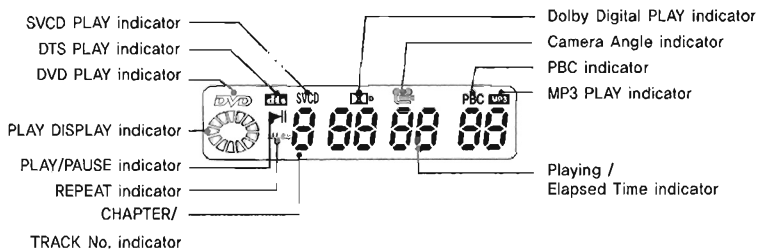

5-3. Main Body(rear part)

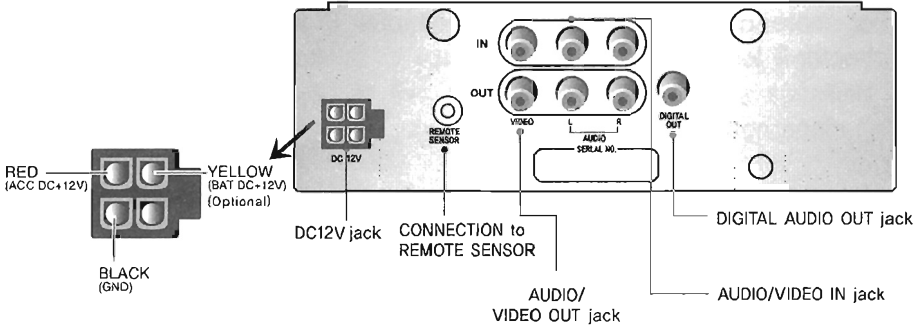

5-4. Accessories



Remote Control



DC Power Cable

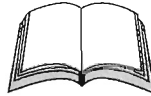

OWNER'S MANUAL

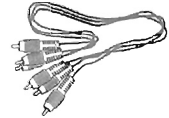

VIDEO/AUDIO Connecting cable

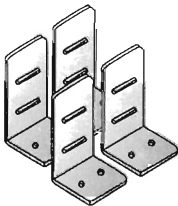

4 Stands



4 Fixing screws



Batteries(2pcs)



Remote eye

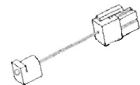

Jack Connector Cable

⚠ Caution

- AC supplier is not include in this player.
If you use AC adapter, please use only adapter of 3A or higher.
- Car Battery can be discharged in a such case that user has operated this product long time without starting a car engine.
- Do not connect cigar jack with car battery directly because it may harm the unit. Do use only DC power cable Supplied in accessories.

5-5. Remote Control

For more details, please refer to chapter 8 for function buttons and chapter 9 for setup.

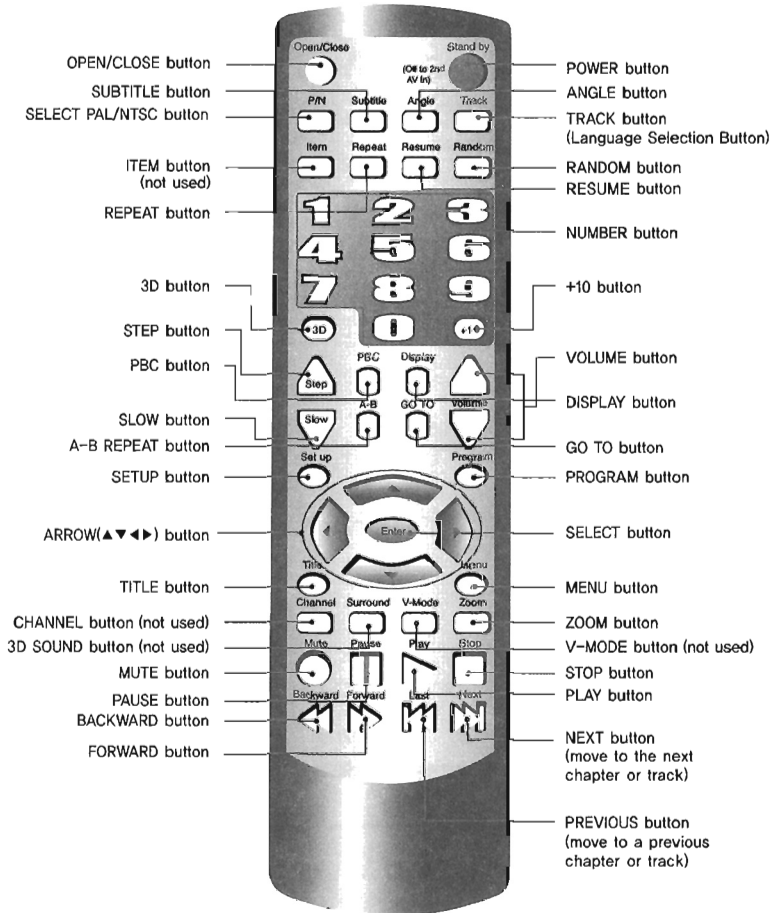

※ Some buttons cannot work subject to models and some of specific Disc.

6. Connecting to System

6-1. Connecting to TV/Monitor

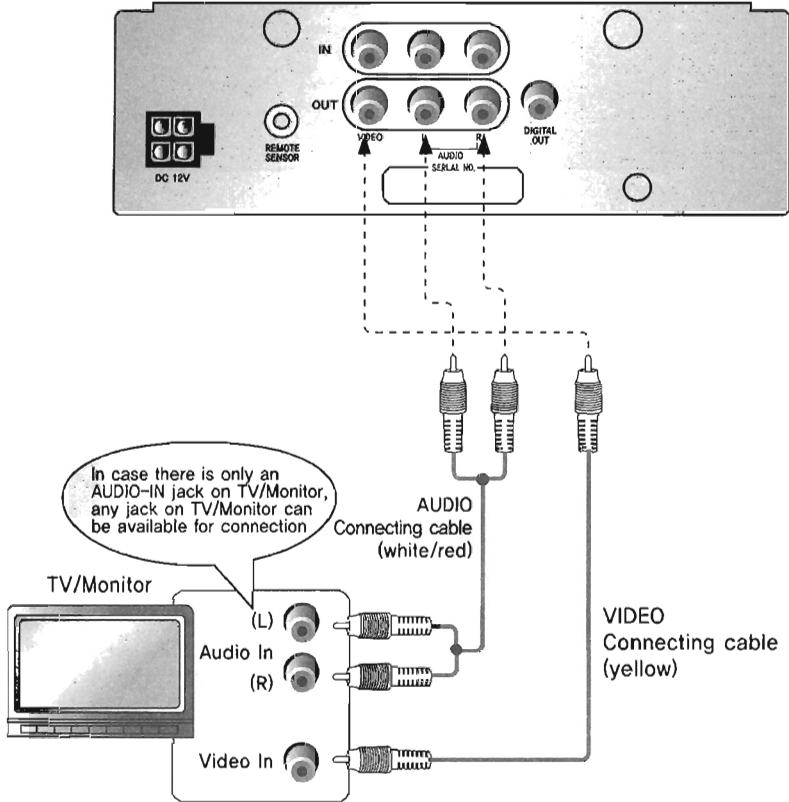

6-2. Connecting to TV/Audio system

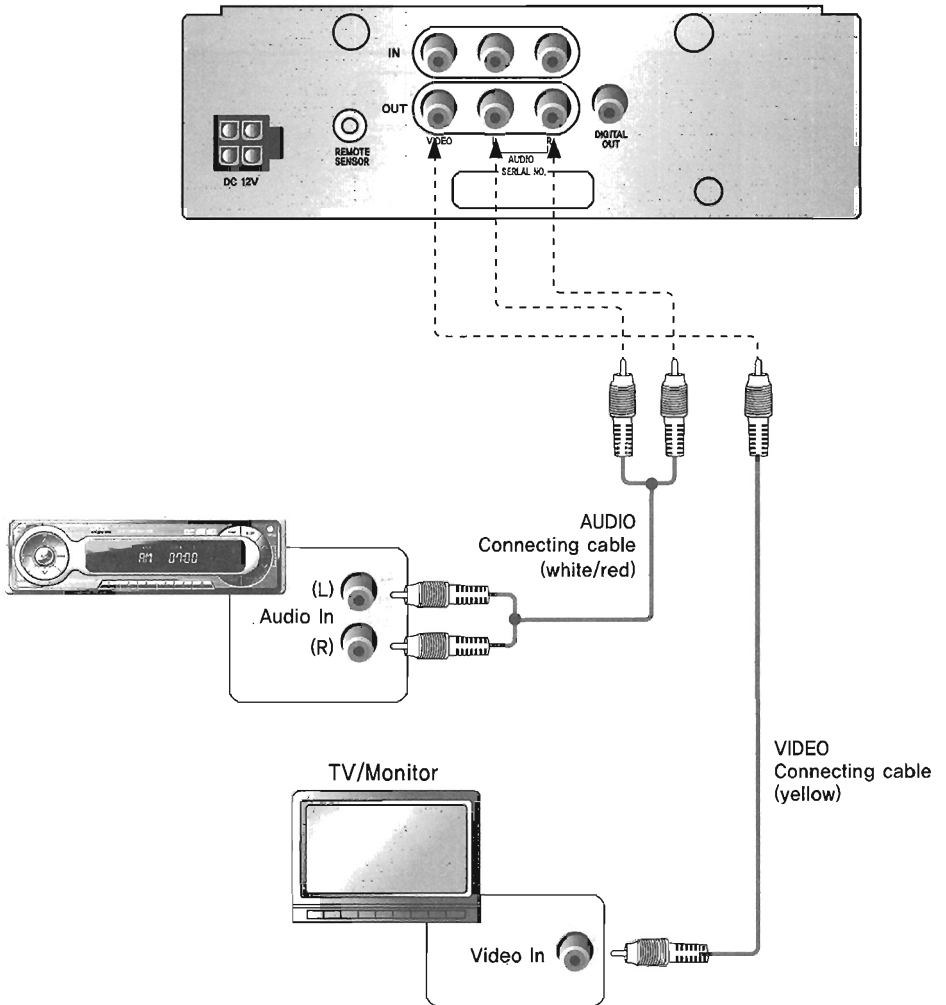

6-3. Connecting to an AMP supporting Dolby Pro Logic

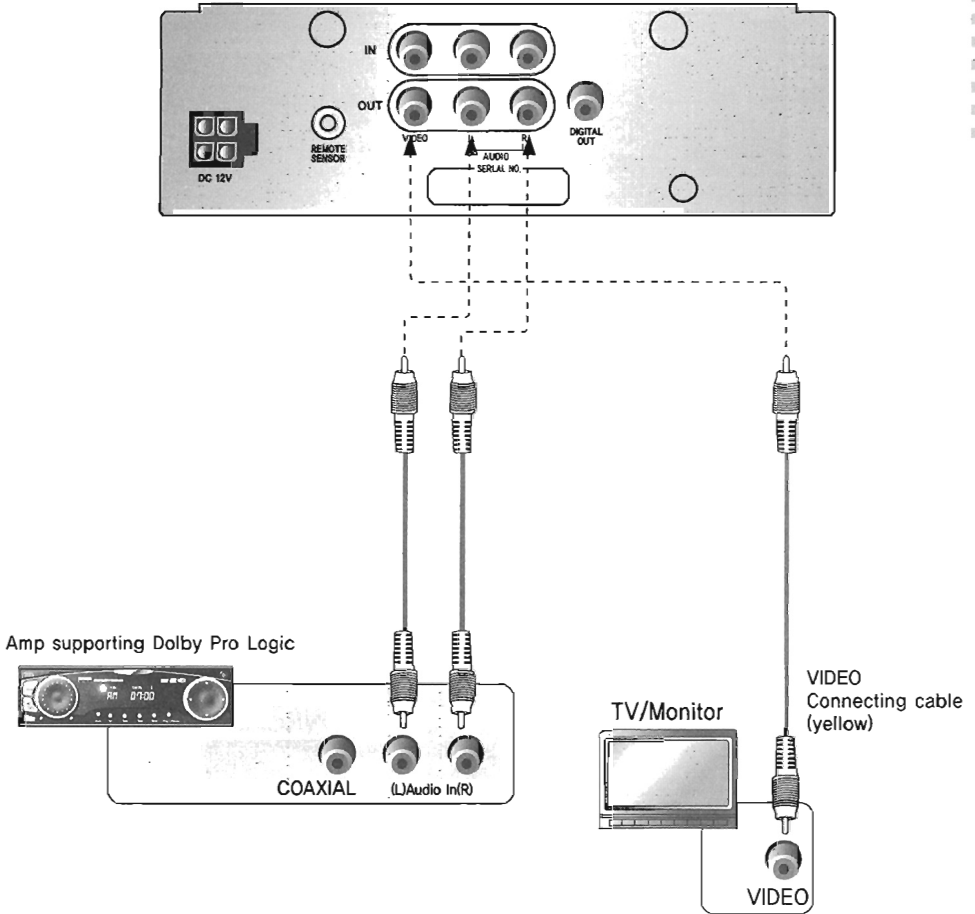

6-4. Connecting to an AMP supporting Dolby Digital

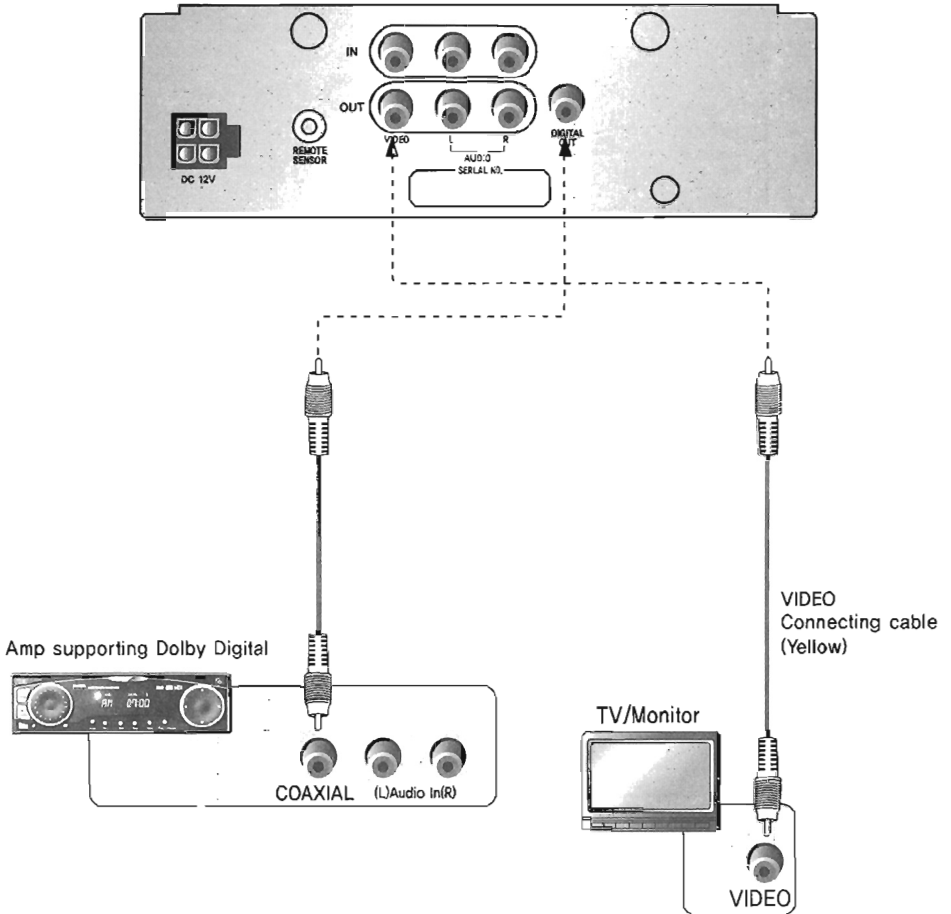

7. DVD Player Operations

* After connection to the system is completed by connection method in Chapter 6, you can check the operations by following steps.

STEP 1:

Press the POWER button, starting logo is displayed in the screen. Then, depending on the disc status (DISC LOADING/NO DISC), the following screen is displayed.

When a disc is loaded

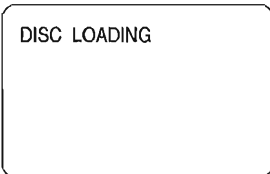

When a disc is not loaded

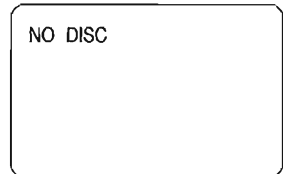

STEP 2:

Press the Open/Close button in remote control or Eject button of the Unit, Tray is opened or closed automatically.

Open/Close disc tray

Open/Close

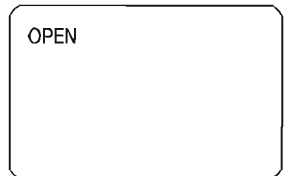

STEP 3:

Load a disc in disc tray and press the Open/Close button, or Eject Button of the Unit, The player identifies disc type automatically and disc type is displayed in the left top of TV screen. And, disc type is also displayed in operating status display of this player. It will automatically start to play.

STEP 4:

If the power button of the Unit or standby button of Remote Controller is pressed, the Unit power is under standby Mode, Again the power button or stand by button is pressed, power turns on and the Unit starts to play automatically.

※When the Unit goes under standby Mode, LED lights on and in this case, If the External input is connected, It will automatically displays external input picture.

8. Function Buttons...

8-1. Screen Display

Press the DISPLAY button during playback of a DVD disc several times, the following screen is displayed.

(Subject to disc type, some screens cannot be displayed.)

During playback of a DVD disc 

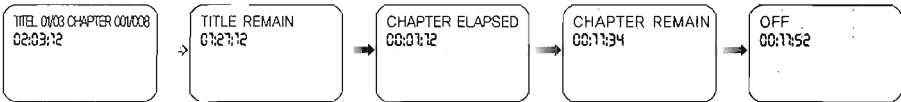

During playback of a
SVCD, CVD, DVCD, VCD, CD

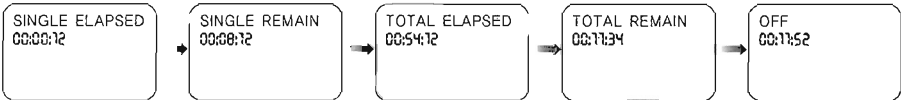

During playback of MP3 

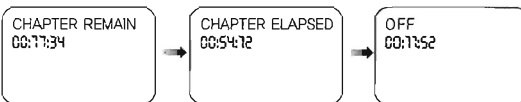

8-2. P/N (Setting of TV receiving method)

Press the P/N button to select a proper TV signal. (NTSC, PAL and MULTI mode is sequentially shown on left top of screen)

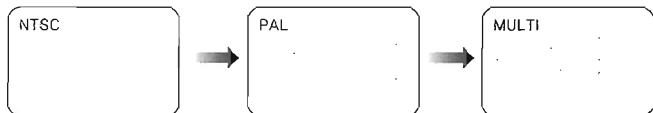
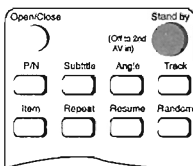

8-3. PBC FUNCTION

PBC ON : If "Playback Control" is written in VCD2.0 disc or the case, you can select specific scene or information using main menu displayed on the TV/monitor.

- ① Press number buttons(0~9) to select a desired main menu displayed.
If you select a desired main menu, submenu is displayed on TV/monitor.
- ② Select specific submenu to be played.
- ③ Press STOP button to stop play. It moves on the prior submenu.
- ④ Press STOP button again to move on main menu.

8-4. RANDOM FUNCTION

① AUDIO CD.

Press STOP button and then RANDOM button while you're listening audio CD. SHUFFLE ON is displayed on TV/monitor. Audio is played in random order, but it does not play repeatedly.

② MP3 CD.

Press STOP button and then RANDOM button.

RANDOM ON is displayed on TV/monitor. Audio is played

In random order, and it does play repeatedly.

③ VCD 2.0.

Use VCD 2.0 with "Playback Control". Press PBC button to turn PBC OFF and RANDOM button.

8-5. Track (Selecting audio language)

Press the TRACK button in remote control several times to select various audio languages. This player supports up to 8 audio languages.(This function can work only in the DVD disc supporting this function)

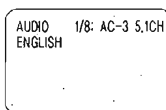

8-6. Angle (Selecting watch angle)

When you watch a DVD disc such as sports or game, press the ANGLE button in remote control several times to watch the same scene from different angles. (This function can work only in the DVD disc supporting this function)



8-7. Subtitle (Selecting subtitle language)

Press the SUBTITLE button in remote control several times to select various subtitle languages.(This function can work only in the DVD disc supporting this function)

SUBTITLE 01/02
ENGLISH

SUBTITLE 02/02
KOREAN

8-8. PROGRAM

- ① Press STOP button. In case of VCD, press PBC button to turn PBC OFF.
- ② Press PROGRAM button. "PROGRAM P 00:00" is displayed on the left-up side of TV/monitor.
- ③ Press number buttons(0-9) to select desired chapters or tracks.
PROGRAM P 00:00 (First 00 : selected tracks, Last 00 : track number)
- ④ Press ENTER button. The selected tracks are played in order.
- ⑤ Press STOP button to stop PROGRAM function.

8-9. ►, ◀, ▲, ▼(Moving to various directions)

You can move the desired direction variously. These buttons allow you to set up other items conveniently.



8-10. Number button

You can use number button to input numbers. To input number 10 or more, press the +10 button and press the next number button.



8-11. GOTO(Selecting the location to play)

- ① Press the GOTO button and select the desired title and chapter or time, playing is started from the selected part. At this time, press the PLAY button to start.
- ② Press the GOTO button first and input the desired Title and Chapter.
- ③ You can input the desired starting time by pressing the GOTO Button once more



8-12. A-B(Playing between two specific points)

- ① Press the A-B button once, starting point is specified.
- ② Press the A-B button twice, ending point is specified. Then, disc is played between specified A and B point repeatedly.
- ③ Press the A-B button three times, A-B Repeat Play function is finished.

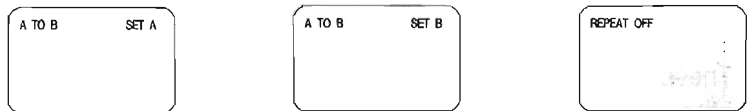

8-13. Repeat(Repeat setup)

Title or chapter can be repeated. In addition, the whole playing track or title can be displayed repeatedly.

During playback of a DVD disc 

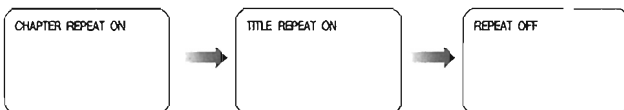

8-14. Zoom(Screen zoom-in or zoom-out)

Every time you press the ZOOM button, screen can be zoomed in one and a half times, double, and quadruple.

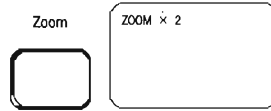

8-15. Volume(Adjusting volume/key)

Press the Δ or Up button of VOLUME buttons, sound goes higher. In contrast, press the ∇ or Down button, sound goes lower.



8-16. Mute(No sound)

Press the MUTE button in remote control once, No sound is released. Again, press it, sound can be heard.



8-17. Play/Stop

During playback, press the STOP button in this player or STOP button in remote control once, stopped point is remembered. At this time, press the PLAY button, playback is started from the stopped point. If once again, press STOP Button of the Remote Controller or the Unit, It will completely stop to play.

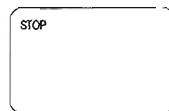
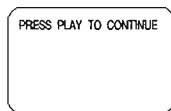
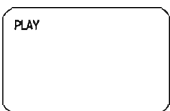

* VCD PLAY

If you want to replay from the stopped scene of VCD, please press PBC button firstly to make PBC OFF as the unit is originally set on PBC ON, and then press STOP button and RESUME button in order. If you do not press PBC button firstly to keep PBC ON, and then do press STOP button, it automatically go to the first scene.

8-18. Pause

If you stop the current playback for a moment, press the PAUSE button. Press the PAUSE button again, playback is re-started.

Pause



8-19. FWD/BWD(Forward/Backward search)

Press the FORWARD/BACKWARD button in remote control repeatedly, screen is played forward or backward at double, quadruple, octuple, and twentyfold speed. If you play a disc at the normal speed, press the PLAY button again. (Subject to disc type, disc can be played at double, treble, quadruple, sextuple, and octuple speed).

8-20. Step(Still picture)

Every time you press the STEP button in remote control, each scene can be displayed. If you like to play the disc in the current status, press the PLAY button.

Step



8-21. Slow

Each time you press SLOW button of remote controller, It plays $\frac{1}{2}$, $\frac{1}{4}$, $\frac{1}{8}$ times in forward Direction and $\frac{1}{2}$, $\frac{1}{4}$, $\frac{1}{8}$ times in backward Direction. If you want to play normal mode, press play button

9. Setup

Load a DVD disc in disc tray and press the SETUP button, initial settings screen is displayed. (Sometimes, if you press the SETUP button, you are required to input password. At this time, input 0000 that is specified initially) To exit the initial settings screen, press the SETUP button again.

You can select the following items in the SETUP menu.

Initial Screen	Sub-screen	Sub-screen
GENERAL SETUP	TV DISPLAY	NORMAL/PS, NORMAL/LB, WIDE
	TV TYPE	MULTI, NTSC, PAL
	PIC MODE	AUTO, HI-RES, N-FLICKER
	ANGLE MARK	ON, OFF
	OSD LANG	ENGLISH
	AUDIO OUT	ANALOG, SPDIF/RAW, SPDIF/PCM
	CAPTIONS	ON, OFF
	SCR SAVER	ON, OFF
AUDIO SETUP	AUDIO MODE	LT/RT, STEREO
DOLBY DIGITAL SETUP	OP MODE	LINE OUT, RF REMOD
	DUAL MONO	STEREO, L-MONO, R-MONO, MIX-MONO
	DYNAMIC	OFF, 2/8, 4/8, 6/8, FULL
PREFERENCES	AUDIO	ENGLISH,FRENCH,SPANISH,CHINESE,JAPANESE
	SUBTITLE	ENGLISH,FRENCH,SPANISH,CHINESE,JAPANESE,OFF
	DISC MENU	ENGLISH,CHINESE,FRENCH,SPANISH,JAPANESE
	LOCALE	CHINA,FRANCE,HONGKONG,JAPAN,TAIWAN,GBR,USA
	PARENTAL	1 G - NO PARENTAL
	PASSWORD	CHANGE
	DEFAULTS	RESET
EXIT SETUP		

9-1. GENERAL SETUP

In the GENERAL SETUP menu, you can select audio and video output.

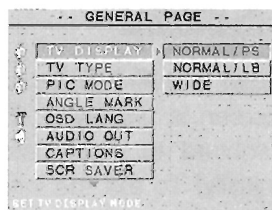

① TV DISPLAY

In initial settings, TV Aspect of screen is set to 4:3. In the TV DISPLAY menu, you can adjust the appropriate screen type according to your TV set.

	4:3				16:9
4:3					
16:9					

② TV TYPE

This Unit supports various TV signal types. The Unit has been default with its country requirement. In addition, you can change this type to MULTI, NTSC, and PAL.

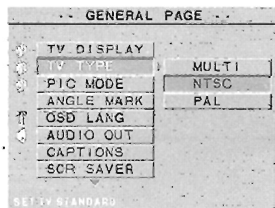

③ PIC MODE

This menu is used for setting screen mode. You can set AUTO, HI-RES, and N-FLICKER and use the high definition and flicker control function.

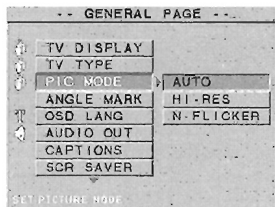

④ ANGLE MARK

If DVD disc supports selecting of watching angle, you can select and watch various angle screen with this menu.

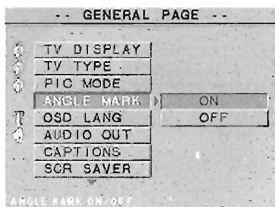

⑤ OSD LANG

You can select OSD displayed language

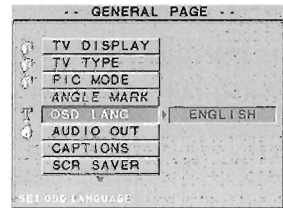

⑥ AUDIO OUT

DVD disc can support various audio out and you can select analog or digital (SPDIF/RAW, SPDIF/PCM) type by the desired Amp or other audio systems. If your Amp or other audio system can receive digital audio input, you just connect the cable to Digital audio out jack in the rear part of this player and then select SPDIF/RAW or SPDIF/PCM type. If digital audio out signal is supplied to audio system or receiver unavailable of digital decoding, it causes high-tone noise and can damage your speakers.

DTS DVD disc sound is displayed only if DVD player is connected to Amp equipped with DTS decoder.

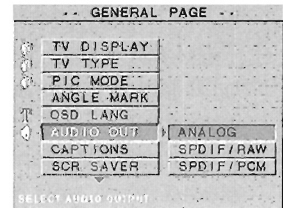

⑦ CAPTION

You can select CAPTION or non-CAPTION mode in screen by setting this menu.

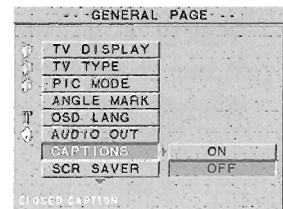

⑧ SCR SAVER

You can select screen saver function in this menu.

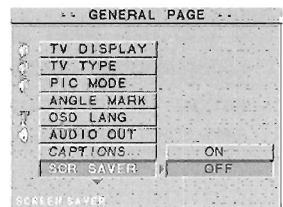

9-2. AUDIO SETUP

In the GENERAL SETUP, select the ANALOG in the audio out menu. Then, DOWN MIX setting menu is displayed.

① AUDIO MODE

If your TV/Monitor set can receive only one audio in and you want to listen with TV/Monitor, you just connect TV/Monitor to L or R jack in the rear part of this player and select the LT/RT in the menu.

If you use TV/Monitor or Amp available of stereo input, you must select STEREO in the menu.

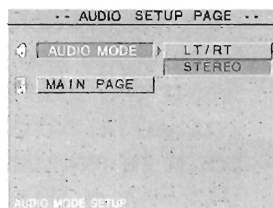

9-3. Dolby Digital SETUP

① OP MODE

In this mode, you can select LINE OUT or RF REMOD. In general, you just select LINE OUT; In use of head phone or other specific cases, you just select RF REMOD.

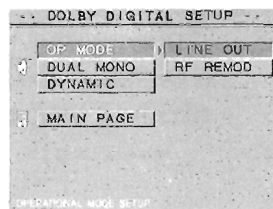

② DUAL MONO

If you use Amp and speaker with 2 channel using Dolby digital for audio out, you can enjoy Dolby sound by selecting STEREO, MONO(L), MONO(R), and MIX MONO.

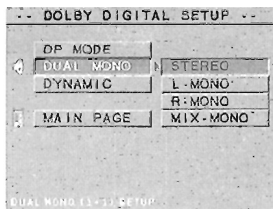

③ Dynamic

This menu is used to adjust dynamic level of voice. If you want to use max dynamic level, you just select FULL in the menu.

In addition, you can get the soft voice clearly without disturbing others at night by using this menu.

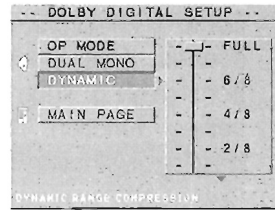

9-4. PREFERENCES

You can control this menu only on tray opened or title unloaded.

①. AUDIO

DVD disc supports various title languages up to 8. You can select the desired language.

(This Feature is only available with the DVD Disc which supports the function.)

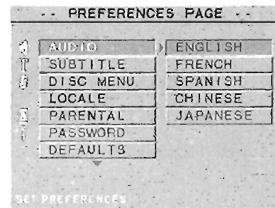

②. SUBTITLE

DVD disc supports various subtitles up to 32. You can select the desired language.

(This Feature is only available with the DVD Disc which supports the function.)

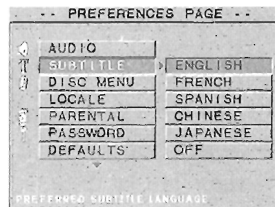

③ DISC MENU

DVD disc contains menu with various languages by regions. You can select the desired language.

(This Feature is only available with the DVD Disc which supports the function.)

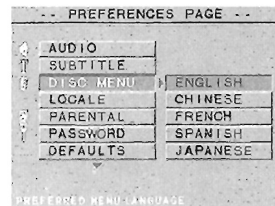

④ PARENTAL

Some DVD discs contains violent and erotic scenes. This function is to prohibit children from playing such DVD discs with password setting function. This DVD player also include 8 rating restriction function.

CAUTIONS:

* For DVD discs rated higher than the level you selected, you must enter a password to watch.

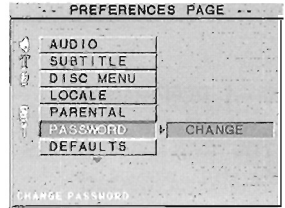
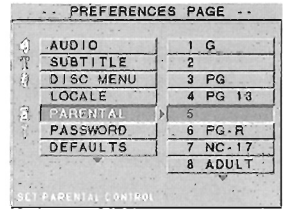

⑤ PASSWORD

In delivery, password is set to 0000.

As needed, you can change the password.

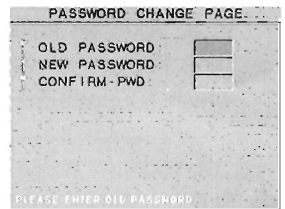

⑥ DEFAULTS

Select the DEFAULTS function, all settings are returned to defaults in delivery.

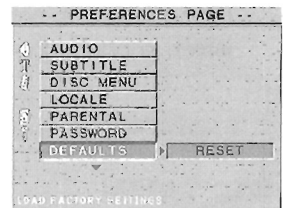

10. Other Functions

10-1. Last Scene Memory(L.S.M) Function (Optional).

This function makes a user watch the last scene memory conveniently without any search when a user replay this unit.

① The model with L.S.M.

It makes a user watch the last scene conveniently when a user replay this unit without any search process even though the power(car engine) is off unexpectedly.

② The model without L.S.M.

It makes a user watch the last scene when a user replay this unit as long as a user press POWER or STAND BY button to turn it off normally.

MP3 Disc Operations.

※DVD, VCD, CD Disc support above feature except MP3 disc.

10-2. MP3 Disc Operations

① If you play a MP3 disc,

Select Last/Next and PLAY button on Remote Controller to enjoy desired track.

② During operation, You may press Random button to play the music regardless of its order.

③ If you want to move on the other folder, press STOP button, move on a desired folder with pressing ARROW(direction) buttons, and press play button.

11. How to install mounting Bracket

1. First, please take the PWMS M3 X 4 <4EA> screws off located on the side parts of cover.

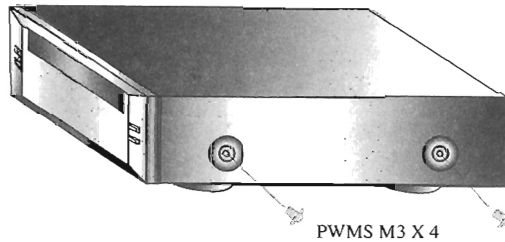

2. Place and install mounting Brackets where PWMS M3 X 4 screws have been tightened.

Make sure to locate mounting Brackets on the proper position and fix them with PWMS M3 X 8 screw <4EA>

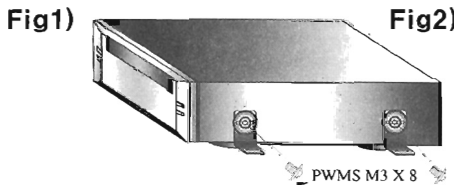

included in Accessories

included in Accessories

3. Tighten the additional screws <8EA> at the place where you want to install.
< We don't supply it within this set as an accessory >

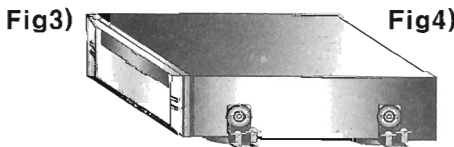

Additional Screws

Additional Screws

12. Specifications

General	Power supply	DC 12V
	Consumption power	24W
	Weight	2.0Kg
	Size	180(W)×222(D)×56(H)mm
	Temperature for normal operation	0° C ~ 50° C
Playable Disc Type	Humidity for normal operation	10%~75%
	DVD (Digital Versatile Disc)	Scanning speed : 3.49~3.84m/sec
		Max. Play speed : 135minutes
	CD(Compact Disc) : 12cm	Scanning speed : 1.2~1.4m/sec
		Max. play speed : 74minutes
	Video - CD : 12cm	Scanning speed : 1.2~1.4m/sec
Max. play speed:74minutes(Video + Audio)		
Video Output	Mixing Video	1.0Vp-p(75Ω load)
Audio Output	2 Channels	Left and Right
	Output Level	Analog sound : 2Vrms(1khz)
		digital sound : 1.15Vp-p
	Frequency Response	48khz sampling : 4Hz~22khz
		96khz sampling : 4Hz~44khz
Digital Output	COAXIAL	
Analog Output	RCA 2CH	

Free Manuals Download Website

<http://myh66.com>

<http://usermanuals.us>

<http://www.somanuals.com>

<http://www.4manuals.cc>

<http://www.manual-lib.com>

<http://www.404manual.com>

<http://www.luxmanual.com>

<http://aubethermostatmanual.com>

Golf course search by state

<http://golfingnear.com>

Email search by domain

<http://emailbydomain.com>

Auto manuals search

<http://auto.somanuals.com>

TV manuals search

<http://tv.somanuals.com>