

**Fellowes**

# Office Thermal Binder

## Helios™ 30

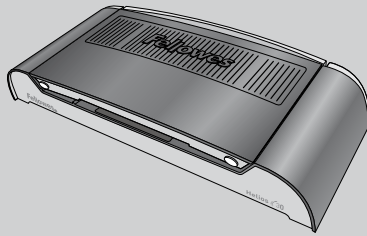

**E**

Please read these instructions before use.

**F**

Lire ces instructions avant utilisation.

**S**

Lea estas instrucciones antes de usar la máquina.

## INDEX

LAMINATOR CONTROLS / QUICK START GUIDE	3
ENGLISH	4-7
FRANCAIS	8-11
ESPAÑOL	12-15

# BINDING MACHINE CONTROLS

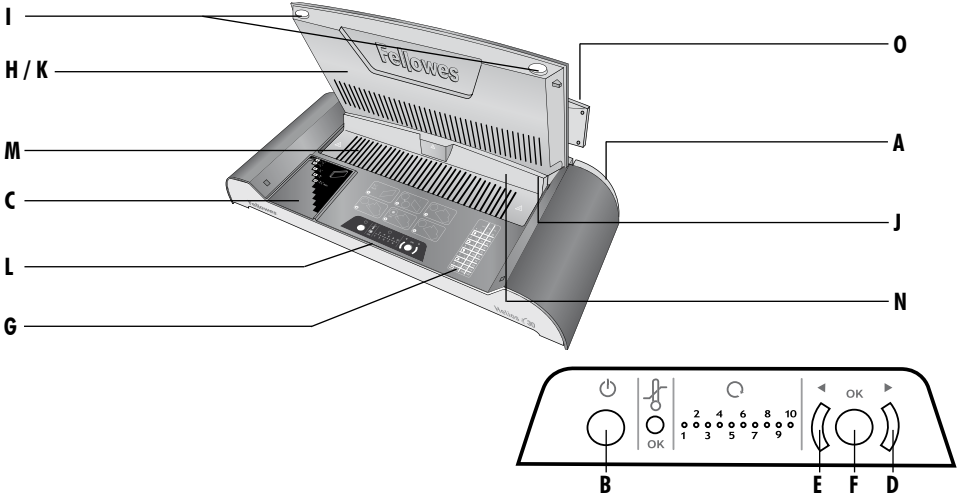

# QUICK START GUIDE

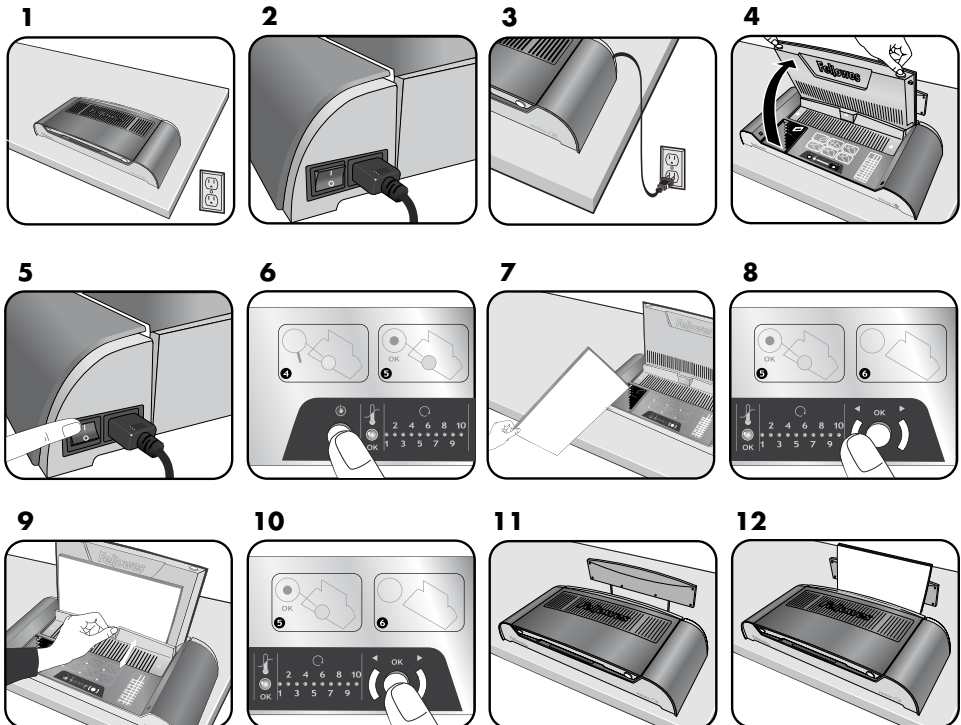

## CAPABILITIES

### Performance

Entry width	12"
Binding capacity (max)	1.2" / 300 sheets (20lb)
Estimated heat-up time	4 minutes
Cool down time	30-60 minutes
Binding cycles	1-10 cycles / 1-2 minutes
Ready indication	Light & beeps
LED interface	Yes
Heat-Shield	Yes
Power Save / Auto shut-off	Yes (30 mins)
Multiple Document Binding	Yes

### Technical Data

Voltage / Frequency / Current(Amps)	110-120V AC, 60Hz, 5.5A
Wattage	600W
Dimensions (HxWxD)	20.9" x 9.4" x 3.9"
Net weight	5.7lb
Binding capacity	The maximum sheet capacity can be a single (up to 300 sheet max) or multiple documents up to approximately 300 sheets max.
Eg:	1 x 300 sheets = 300 max 5 x 60 sheets = 300 max 10 x 15 sheets = 150 max

## IMPORTANT SAFETY INSTRUCTIONS



**CAUTION:** Please read before use and keep for future reference.

When binding;

- plug the machine into an easily accessible socket.

- to prevent electrical shock - do not use the appliance close to water, do not spill water on to the appliance, power cord or wall socket.

**DO** ensure the machine is on a stable surface.

**DO** test scrap sheets and set the machine before use.

**DO** remove staples and other metal articles prior to binding.

**DO** keep the machine away from heat and water sources.

**DO** turn off the machine after each use.

**DO** unplug the machine when not in use for an extended period.

**DO** use binding covers designed for use at the appropriate settings.

**DO** keep away from pets, while in use.

**DO NOT** leave the power cord in contact with hot surfaces.

**DO NOT** leave power cord hanging from cupboards or

shelves.

**DO NOT** use appliance if the power cord is damaged.

**DO NOT** attempt to open or otherwise repair the machine.

**DO NOT** exceed the machines quoted performance.

**DO NOT** allow children to use this machine without adult supervision.

**DO NOT** bind sharp or metal objects (eg: staples, paper clips).

**DO NOT** bind heat-sensitive documents (eg: tickets, ultra-sounds etc).







**DO NOT** touch the heating plate while binding - it is very hot.

## STORAGE & CLEANING

Unplug the machine at the wall. Allow the machine to cool.

The outside of the machine can be cleaned with a damp cloth. Do not use solvents or flammable materials to polish the machine.

## BINDING MACHINE CONTROLS

A	On/off switch (rear side)	I	Lid lock (2)
B	Power On button & LED 	J	Binding channel
C	Binding thickness guide	K	Document support
D	Timer selection (increase) 	L	Illuminated user interface
E	Timer selection (decrease) 	M	Cooling vents
F	Select / OK button 	N	Document clamp (binding)
G	Thickness setting / timer selection	O	Cooling rack
H	Lid		

## FEATURES & TIPS



### 'System-Check' function

When switched on, the machine performs a 'System-Check' function. The control panel illuminates LED neons in sequence to check their operation.



### 'Heat-Shield' function

The document clamp operates as a 'Heat Shield' to prevent operators from accidentally touching the heating plate.



### 'Auto-Off' function

If the machine is not active for 30 minutes, the 'Auto-Off' function will place the machine into standby mode. The 'Power-On' LED will flash red and green. To operate the machine, press the 'Power-On' button.

- Always put the document into the appropriate sized binding cover.
- For better results, consider including blank sheets to fill the thermal cover to capacity.
- Always test bind with a similar size and thickness of thermal covers before final process.
- Helios has an angled heater mechanism to ensure correct document alignment with the document support during the binding process.
- For best results, use Fellowes® brand supplies.
- Thermal binding covers work best with thin and uncoated types of paper. Care should be taken with thick and coated papers to ensure satisfactory results.
- If the sheets have not been glued completely to the cover, the document can be re-processed to improve the result.
- Ensure the sheets are well aligned and touching the glued spine of the thermal cover by tapping the collated document in the cover onto a flat surface. This can be done before and after the binding process.

## BEFORE BINDING

1. Ensure the machine is on a stable surface. Check there is enough clear space around the machine to operate safely.
2. Insert the power lead into the power socket (located at the rear of the machine).
3. Plug the machine into an easily accessible main socket. Switch the main supply on.
4. Open and lift the lid by releasing the safety catches on the front of the lid.

## HOW TO BIND

5. Switch the power on (located at the rear side).
6. The 'Power-On' button will be red. To activate the machine, press the 'Power-On' button on the control panel. The machine will warm-up, the red LED will flash. The machine will 'beep' (3x) and the LED turns green when the machine is ready to bind.
7. Prepare the documents by loading the sheets into the thermal covers. For best results, do not place too many or too few sheets into the cover. Use the binding thickness scale as a guide. The guide is calibrated in 6mm widths. Helios 30 will accept single or multiple documents up to a combined total thickness of 1.25" (approximately 300 sheets / 20lb).
8. The selected binding cycle is shown with blue LED. Use the timer selection buttons to navigate up or down the scale, if required. The scale has 10 settings. Eg: 0.25" document thickness = setting 1 (up to 60 sheets), 1.25" document = setting 10 (up to 300 sheets).
9. Pull open the document clamp (Heat-Shield feature), insert the documents into the binding channel. Ensure the binding covers spine touches the heating element.
10. Start the binding cycle by pressing the 'Select / OK' button. The blue LED will start flashing and counting down, in sequence. When the cycle is complete, the machine will beep (3x). The blue LED will switch off.
11. The machine has an integral cooling tray. It can be extended from the back of the machine and can also be pulled upwards to accept larger documents.
12. When the binding cycle is complete, immediately remove the documents and place in the cooling tray or on a flat surface to allow the document to cool. The document can be removed from the machine mid-cycle if required, take care – the glue may be hot and melted.

## NEED HELP?

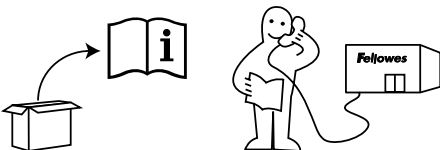

Let our experts help you with a solution.

Customer Service... **www.fellowes.com**

Always call Fellowes before contacting your place of purchase, see the rear cover for contact details.

## TROUBLESHOOTING

Problem	Possible cause	Solution
No 'red' power on LED	Machine is not switched on	Switch on machine at rear next to plug inlet and at the wall socket
No 'green' ready light after a long period	Machine is in a hot or humid area	Move the machine to a cooler and dry area
Loose and unglued sheets	Binding cover may be too thick to bind	Process the documents again, ensure sheets are in contact with the glued spine by tapping gently on a flat surface
	Timer setting may be incorrect	Check timer setting is correct and process the document again
Loose and glued sheets	The cover size is too small for the number of sheets	Check the number of sheets is appropriate for the cover width. Select larger spine width if necessary
	Extended heating cycle	Check timer setting is correct. Ensure prompt document removal
	Timer setting may be incorrect	
	Documents left on the heater plate after the cycle is complete	

## WORLDWIDE WARRANTY

Fellowes warrants all parts of the binder to be free of defects in material and workmanship for 2 years from the date of purchase by the original consumer. If any part is found to be defective during warranty period, your sole and exclusive remedy will be repair or replacement, at Fellowes' option and expense, of the defective part. This warranty does not apply in cases of abuse, mishandling or unauthorised repair. Any implied warranty, including that of merchantability or fitness for particular purpose, is hereby limited in duration to the appropriate warranty period set forth above. In no event shall Fellowes be liable for any consequential damages attributable to this product. This warranty gives you specific legal rights. You may have other legal rights that vary from this warranty. The duration, terms and conditions of this warranty are valid worldwide, except where different limitations, restrictions or conditions may be required by local law. For more details or to obtain services under this warranty, please contact Fellowes or your dealer.

## PRODUCT REGISTRATION

Thank you for purchasing a Fellowes product. Please visit [www.fellowes.com/register](http://www.fellowes.com/register) to register your product and benefit from product news, feedback and offers. Product details can be found listed on the rating plate positioned on the rear side or underside of the machine.



## Useful Phone Numbers

### FCC CLASS B NOTICE - NOTIFICATION POUR LES ETATS-UNIS

Note: This equipment has been tested and found to comply with the limits for a Class B digital device, pursuant to part 15 of the FCC Rules. These limits are designed to provide reasonable protection against harmful interference in a residential installation. This equipment generates, uses and can radiate radio frequency energy and, if not installed and used in accordance with the instructions, may cause harmful interference to radio communications. However, there is no guarantee that interference will not occur in a particular installation. If this equipment does cause harmful interference to radio or television reception, which can be determined by turning the equipment off and on, the user is encouraged to try to correct the interference by one or more of the following measures:

- Reorient or relocate the receiving antenna.
- Increase the separation between the equipment and receiver.
- Connect the equipment into an outlet on a circuit different from that to which the receiver is connected.
- Consult the dealer or an experienced radio/TV technician for help.

### CANADA CLASS B NOTICE - AVIS CANADA, CLASSE B

This Class B digital apparatus complies with Canadian ICES-003.

Cet appareil numérique de la classe B est conforme à la norme NMB-003 du Canada.

### MODIFICATIONS

Any modifications made to this device that are not approved by Fellowes may void the authority granted to the user by the FCC and/or by Industry Canada to operate this equipment.

Toutes modifications apportées à ce dispositif et non approuvées par Fellowes annuleront le droit accordé à l'utilisateur par le FCC et/ou par Industrie Canada de faire fonctionner cet équipement.

### Fellowes

Australia	+61-3-8336-9700	Korea	+82-(0)-2-3462-2844
Benelux	+31-(0)-76-523-2090	Malaysia	+60-(0)-35122-1231
Canada	+1-905-475-6320	Polska	+48-(22)-771-47-40
Deutschland	+49-(0)-5131-49770	Russia	+7-(495)-228-14-03
España / Portugal	+ 34 902 33 55 69	Singapore	+65-6221-3811
France	+33-(0)-1-78-64-91-00	United Kingdom	+44-(0)-1302-836836
Italia	+39-71-730041	United States	+1-630-893-1600
Japan	+81-(0)-3-5496-2401		



1789 Norwood Avenue, Itasca, Illinois 60143-1095 • USA • 630-893-1600

[fellowes.com](http://fellowes.com)

Australia  
Benelux

Canada  
China

Deutschland  
España

France  
Italia

Japan  
Korea

Polska  
Singapore

United Kingdom  
United States



## Free Manuals Download Website

<http://myh66.com>

<http://usermanuals.us>

<http://www.somanuals.com>

<http://www.4manuals.cc>

<http://www.manual-lib.com>

<http://www.404manual.com>

<http://www.luxmanual.com>

<http://aubethermostatmanual.com>

Golf course search by state

<http://golfingnear.com>

Email search by domain

<http://emailbydomain.com>

Auto manuals search

<http://auto.somanuals.com>

TV manuals search

<http://tv.somanuals.com>