

Fellowes



220-2
220C-2

English

Français

Español

Deutsch

Italiano

Nederlands

Svenska

Dansk

Suomi

Norsk

Polski

Русский

Get More Done Today™

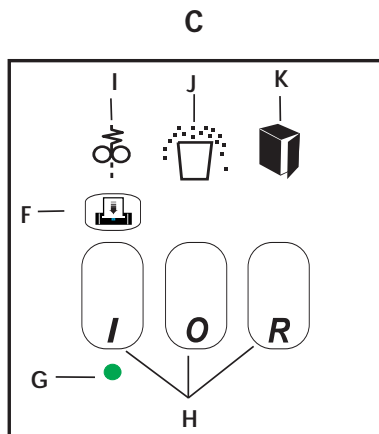
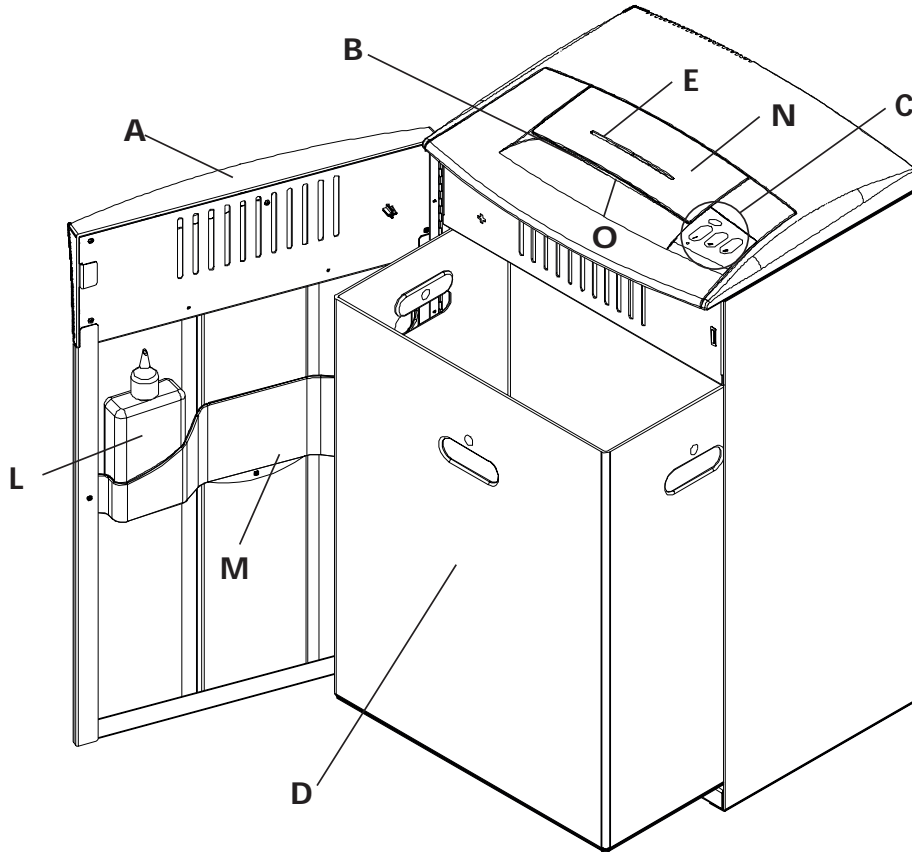

Fellowes.

Dear Customer,

Thank you for buying a Fellowes Commercial Shredder. We have made many improvements in our commercial shredder since its introduction in 1982. We are confident that it offers you the greatest value for your money in its product category today. We hope it meets – or even exceeds – your expectations.

To ensure years of safe, efficient use, please read these few pages about your new shredder. If this manual doesn't answer all your questions or if you wish to comment on this product, we welcome your call or letter.

Sincerely,

*James Fellowes
Chairman & CEO*

Contents

Product Profile	3
Important Safety Instructions	3
Set-Up	4
Operation	4
Maintenance	5
Troubleshooting	6
Supplies	6
Warranty	7

Product Profile

This product is built to shred **paper, staples, small paper clips and credit cards**. It is not built to shred adhesive labels, transparencies, newspaper, cardboard, large paper clips, or plastic (other than credit cards). Attempting to shred items not intended for this shredder may cause damage.



	Strip-Cut (220-2)	Strip-cut (220-2)	Confetti-cut (220C-2)
Sheet capacity*	18-20 sheets	16-18 sheets	12-14 sheets
Paper shred size	5,8 mm	3,9 mm	3,9 x 25 mm
Maximum paper width	241 mm	241 mm	241 mm
Recommended daily capacity	6,000 sheets	6,000 sheets	3,000 sheets

*Based on A4 (70 g/m²) paper with shredder operating at rated voltage; heavier paper, high humidity, or other than rated voltage may reduce sheet capacity.

IMPORTANT SAFETY INSTRUCTIONS READ ALL INSTRUCTIONS BEFORE USING

While setting up shredder

- Check shredder for damage or defects; some paper particles in the basket are normal due to product testing and does not indicate a defect.
- Avoid touching exposed blades on underside of confetti-cut shredder head.
- Plug power cord in an outlet that can easily be reached. The plug is the primary electrical disconnect.
- Make sure the electrical rating listed on the serial label (located near the power cord on the back of the shredder) matches the available electric power.
- Do not place shredder near or over a heat or water source.

While operating shredder

- Keep hands and hanging objects (jewelry, ties, loose clothing, long hair, etc.) away from paper entry.
- Keep children and pets away from the shredder.



When not in use

- Always turn off and unplug shredder.
- Unplug before emptying basket.
- Do not open shredder head: Danger of electric shock. Opening shredder head will void the warranty.



NOTE: Do not use flammable synthetic oil, petroleum-based products or aerosols of any kind on or near product at any time.

Set-Up

- Make sure the back of the shredder is at least 5 cm away from walls or furniture to ensure sufficient ventilation.
- Open the cabinet door and pull the waste basket (D) completely out of the cabinet.
- Put plastic waste bag in basket (sample bags provided). Allow bag edges to overhang. Contact Fellowes to order more bags (part # 36054).
- Slide the waste basket into the cabinet and shut the cabinet door (A).
- Plug the power cord into a convenient outlet.
- Store use and care manual in slot (M) inside cabinet door (A).

Operation

Control Switches

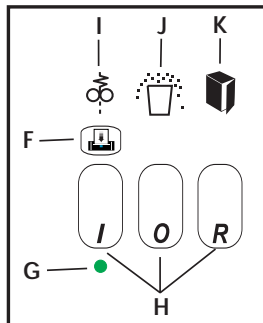

Control Switch (H)

- I AUTOMATIC**
Turns on the automatic-start sensor and the green Ready light.
- O OFF**
Turns off the automatic-start sensor and the green Ready light.
- R REVERSE**
Runs shredder in reverse mode. Press and hold to activate.

Manual Forward Button (F)

Runs shredder when button is held down. 

Troubleshooting Lights



Shredder is in automatic start mode.



Shredder is jammed (e.g., too much paper fed at one time).



Waste basket is full or paper has collected under cutting cylinders.



Cabinet door is open.

For convenience and energy savings, your shredder is equipped with an **automatic-start sensor** (O). This means that when the control switch (H) is in the automatic [I] position, the shredder will start running when you put paper into it and stop a few seconds after the paper has passed through.

CAUTION: The automatic-start sensor cannot tell the difference between paper and other objects. This feature can also be a hazard. Always turn off the shredder when it is not in use. Unplug the shredder if it will not be used for an extended period.



To shred paper

- Press the automatic [I] button. The green ready light (G) should turn on.
- Feed paper straight into paper entry (B) releasing when the shredder begins shredding.

To shred CDs (Model 220-2 only)

- Feed one CD straight into CD entry (E) releasing when the shredder begins shredding.

To empty waste basket

If basket full light (J) is on, follow these steps until light turns off.



- 1
 - Press manual forward button (F) to finish shredding any paper in the paper entry.
 - Press the off [O] button.
 - Open the cabinet door (A) and pull out the waste basket (D).
 - Remove the full bag and replace with a new bag.
 - Slide the waste basket (D) into the cabinet and shut the cabinet door (A).
- 2
 - Press and hold the reverse [R] button for a few seconds to clear paper shreds that have collected under cutting cylinders.
 - Alternate between manual forward (F) and reverse [R] for a few seconds in each position.

CAUTION: The shredder may be damaged if you alternate too rapidly between forward and reverse.
- 3
 - Unplug shredder, open cabinet door (A) and remove wastebasket (D).
 - Carefully clear any paper shreds that have collected on under side of paper entry (B).

CAUTION: Model 220C-2 (confetti cut model) has exposed blades on underside of paper entry. Use care when removing paper shreds.

To clear a paper jam

If paper jam light (I) is on, follow these steps until light turns off.



- Check the waste basket (D) and empty the bag if full.
 - Press and hold the reverse [R] button to back paper out of the paper entry (B). Try pulling gently on the paper to remove it from the shredder.
 - Alternate between forward and reverse, as needed, until the jam clears:
 - Press and hold the manual forward button (F) for a few seconds.
 - Press and hold the reverse [R] button for a few seconds.
 - Continue alternating between forward and reverse until the jam clears.
- CAUTION:** The shredder may be damaged if you alternate too rapidly between forward and reverse.

Maintenance

Empty waste basket regularly to ensure the smooth functioning of the cutting cylinders. The shredder will not operate when the basket is full.

Oil **confetti-cut model** (220C-2) regularly to ensure proper operation.

If used at or near daily capacity, apply oil every time you empty the basket.

Use Fellowes Powershred Lubricant #35250 or other non-aerosol vegetable-based oil in a long-nozzle container (sample oil provided).





CAUTION: Do not use flammable synthetic oil, petroleum-based products, or aerosol lubricants of any kind.

To oil the cutting cylinders

- Lift paper entry flap (N) and apply oil over full width of cutting cylinders through the paper entry (B).
- Press and hold the manual forward button (F) for at least 3 seconds.
- Press and hold the reverse [R] button for at least 3 seconds.
- Repeat the forward/reverse sequence 3 or more times.
- Store oil bottle in slot (L) inside cabinet door (A).

Troubleshooting

If there is a problem with your shredder, check these symptoms and remedies. If you cannot solve the problem, call your local dealer or contact Fellowes directly. **Do not open shredder head** to attempt repair. You could be exposed to serious electric shock and will void the warranty.

Symptom		Remedy
Ready Light (G) will not light		Make sure shredder is plugged in. Press the automatic button [I].
Shredder does not start or stops while shredding		<ul style="list-style-type: none"> • Make sure shredder is plugged in. Check Troubleshooting lights. • Clear paper jam. Follow the instructions under <i>Operation</i>.
Door ajar light (K) is on		Make sure the cabinet door (A) is closed.
Basket full light (J) is on		Empty the waste basket. Follow the instructions under <i>Operation</i> .
Paper jam light (I) is on		Clear paper jam. Follow the instructions under <i>Operation</i> .
Confetti-cut shredder (220C-2): Shredder sheet capacity decreases, noise level increases, or cutting cylinders stop with a squeak or rubbing sound		Oil the cutting cylinders. Follow the instructions under <i>Maintenance</i> .
Shredder runs for a few seconds after the paper has cleared the cutters		No action required. This is a self-cleaning function.

Supplies

The following items for the 220-2 and 220C-2 shredders are available from Fellowes:

Item	Quantity	Part Number
Waste bags (in dispenser)	50/roll	36054
Waste basket (box)	1 box	400005
Powershred Lubricant (220C-2 only)	12 oz. bottle	35250

To purchase supplies, contact Fellowes at the appropriate location listed on the back page of this instruction manual, or visit us at www.fellowes.com.

Fellowes conducts extensive testing to ensure that these shredders are capable of meeting all of the specifications listed in the Product Profile (see page 3). However, the actual sheet capacity is dependent on a number of factors including the type and weight of paper, the humidity, the voltage level of the power source, the temperature of the motor, and the care with which the operator feeds the paper. Safety agency testing is conducted to ensure that the shredder will operate to specifications even if the available voltage is 10% below or 6% above the rated voltage. During this testing 2.5 minutes was taken to empty the basket each time it filled and the following capacities were used for temperature rise testing:

Voltage	Hertz	Cut Size & Type	Number of Sheets	Paper Size & Weight
220-240 VAC	50 Hz	3,9 mm Strip Cut	17	A4 70 g
220-240 VAC	50 Hz	5,8 mm Strip Cut	19	A4 70 g
220-240 VAC	50 Hz	3,9 mm Confetti Cut	13	A4 70 g
120 V	60 Hz	5,8 mm Strip Cut	19	8.5x11 20 lb
120 V	60 Hz	3,9 mm Confetti Cut	13	8.5x11 20 lb
100 V	50/60 Hz	3,9 mm Strip Cut	17	A4 70 g
100 V	50/60 Hz	3,9 mm Confetti Cut	13	A4 70 g

Limited Warranty

Fellowes, Inc. ("Fellowes") warrants the cutting blades of the machine to be free from defects in material and workmanship for 20 years from the date of purchase by the original consumer. Fellowes warrants all other parts of the machine to be free of defects in material and workmanship for 2 years from the date of purchase by the original consumer. If any part is found to be defective during the warrant period, your sole and exclusive remedy will be repair or replacement, at Fellowes' option and expense, of the defective part.

This warranty does not apply in cases of abuse, mishandling or unauthorised repair. ANY IMPLIED WARRANTY, INCLUDING THAT OF MERCHANTABILITY OR FITNESS FOR A PARTICULAR PURPOSE, IS HEREBY LIMITED IN DURATION TO THE APPROPRIATE WARRANTY PERIOD SET FORTH ABOVE. In no event shall Fellowes be liable for any consequential or incidental damages attributable to this product. This warranty gives you specific legal rights. You may have other legal rights that vary. The duration, terms and conditions of this warranty are valid worldwide, except where different limitations, restrictions or conditions may be required by local law.

For more details or to obtain service under this warranty, please contact:

EUROPEAN CONSUMER HELPLINE
00 800 1810 1810
(Accessible via most major telephone networks)

OR the nearest Fellowes location listed on the back page of this user manual.

Warrantor: Fellowes, Inc.

Declaration of Conformity

Fellowes
Yorkshire Way, West Moor Park,
Doncaster, South Yorkshire, DN3 3FB England

declares that the product
Models 220-2 and 220C-2
conform with the requirements of the Low Voltage Directive (73/23 EEC) and the
Electromagnetic Compatibility Directive (89/336 EEC) and the following harmonized
European Normes (EN Standards) and IEC Standards.

Safety: EN60950 'Information Technology Equipment'

EMC:	Standard	Severity Level	Performance Criteria
	EN 61000-4-2: 1995	3AD, 2CD	B
	EN 61000-4-4: 1995	2	B
	EN 61000-4-5: 1995	2DM, 3CM	B
	EN 61000-4-6: 1996	2	A
	EN 61000-4-11: 1994	per table 13	C
	EN55014-1:2000		
	EN 61000-3-2;1995	Class A	
	+A1: 1998, +A2: 1998, +A14:2000		
	EN 61000-3-3:1995		
	+A1:2001		

Itasca, Illinois, USA
2 September 2002

Anthony Storrie

All European Countries
European Consumer Helpline
00 800 1810 1810

(Accessible via most major telephone networks)

France	+ 33 (0) 2-99-22-71-22
Germany	+ 49 (0) 5131-4977-0
Italy	+ 39 (0) 071-730041
Poland	+ 48-22-837-7356
The Netherlands	+ 31 (0) 347-377988
United Kingdom	+ 44 (0) 1302-836836

www.fellowes.com

Fellowes 1789 Norwood Avenue Itasca, Illinois 60143-1095 630-893-1600 Customer Service 1-800-945-4545 <http://www.fellowes.com>

Australia Tullamarine, Vic	Benelux Vianen, NL	Canada Markham, Ont.	France Paris Rennes, I-V	Germany Garbsen, Han.	Italy Camerano, AN	Japan Tokyo	Korea Seoul	Poland Warsaw	Singapore Singapore	United Kingdom Doncaster, S. Yorks.
-------------------------------	-----------------------	-------------------------	--------------------------------	--------------------------	-----------------------	----------------	----------------	------------------	------------------------	--

© 2002 Fellowes Printed in China. Form No. 400007

Free Manuals Download Website

<http://myh66.com>

<http://usermanuals.us>

<http://www.somanuals.com>

<http://www.4manuals.cc>

<http://www.manual-lib.com>

<http://www.404manual.com>

<http://www.luxmanual.com>

<http://aubethermostatmanual.com>

Golf course search by state

<http://golfingnear.com>

Email search by domain

<http://emailbydomain.com>

Auto manuals search

<http://auto.somanuals.com>

TV manuals search

<http://tv.somanuals.com>