

# FESTOOL

## **TS 55 REQ** **Guided Circular Saw**



## **Guided Circular Saw** **Supplemental User's Manual**



**WARNING** To reduce the risk of serious injury, read and understand all safety precautions and instructions in this manual before using this tool.

---

# Limited Warranty<sup>1</sup>

## 30 Day Money Back Guarantee

Buy with confidence. If you are not completely satisfied, return your tool<sup>2</sup> to the selling dealer within 30 days and you will receive a refund of either your purchase price or the lowest retail price at which the same item has been offered since your date of purchase. Freight charges are not refundable.

---

## 1+2 Limited Warranty

Festool offers a 3 year limited warranty, one of the strongest in the industry. This warranty is valid on the pre-condition that the tool is used and operated in compliance with the Festool operating instructions. Festool warrants that the specified tool will be free from defects in materials and workmanship for a term of 3 years from the date of purchase.

---

## Conditions of 1+2 Limited Warranty

All customers receive a free extended limited warranty (1 year + 2 years = 3 Years) on new Festool power tools purchased from an authorized retailer. Festool is responsible for all shipping costs during the first year of the warranty. During the second and third year of the warranty the customer is responsible for shipping the tool to Festool. Festool will pay for return shipping to the customer using UPS Ground Service. All warranty service is valid 3 years from the date of purchase on your receipt or invoice. Proof of purchase may be required.

Excluded from the coverage under this warranty are: normal wear and tear, damages caused by misuse, abuse, or neglect; damage caused by anything other than defects in material and workmanship. This warranty does not apply to accessory items such as circular saw blades, drill bits, router bits, jigsaw blades, sanding belts, and grinding wheels. Operating a tool at a voltage or frequency different from the tool's rating will void the warranty. This includes the usage of the tool in combination with a transformer. Festool does not condone nor support the use of any non-Festool engineered, designed, and manufactured accessories or consumables with Festool products. Use of any non-Festool products may affect performance or void the warranty. Festool is not responsible for any damages or losses incurred and user assumes all risk and responsibility with non-Festool derived products. Also excluded are "wearing parts," such as carbon brushes, lamellas of air tools, rubber collars and seals, sanding discs and pads, and Festool gear (hats and shirts).

<sup>1</sup> The following is an exemplar Festool limited warranty. The actual warranty that comes with your power tool is controlling.

<sup>2</sup> Tool must be returned in complete and whole condition as supplied to include Systainer, cutter, blade, power cord, etc.

---

## Liability Statement

This product has been built to the high standards of Festool. Please do not attempt to operate or repair this equipment without adequate training. Any use, operation, or repair in contravention of this document is at your own risk. By acceptance of this system you hereby assume all liability consequent to your

---

## Proprietary Notice

All drawings and information herein are the property of Festool, TTS Tooltechnic Systems AG & Co. KG. All unauthorized use and reproduction is prohibited.

Written and Illustrated by Rick Christopherson.

© 2013 TTS Tooltechnic Systems AG & Co. KG

All rights reserved. Printed in the United States of America and Germany.

The obligations of Festool in its sole discretion under this warranty shall be limited to repair or replacement or a refund of the purchase price for any Festool portable power tool that is found to have a defect in materials or workmanship during the warranty period. FESTOOL SHALL NOT BE LIABLE FOR ANY CONSEQUENTIAL, INCIDENTAL OR SPECIAL DAMAGES REGARDLESS OF THE THEORY OF LAW ON WHICH THE CLAIM IS BASED. ALL WARRANTIES IMPLIED BY STATE LAW, INCLUDING THE IMPLIED WARRANTIES OR MERCHANTABILITY AND FITNESS FOR A PARTICULAR PURPOSE ARE HEREBY LIMITED TO THE DURATION OF THREE YEARS.

Some states in the U.S. and some Canadian provinces do not allow the limitations on how long an implied warranty lasts, so the above limitation may not apply to you. This warranty gives you specific legal rights, and you may also have other rights that vary from state to state in the U.S. and from province to province in Canada.

With the exception of any warranties implied by state or province law as limited above, the foregoing express limited warranty is exclusive and in lieu of all other warranties, guarantees, agreements, and similar obligations of Festool. Festool makes no other warranty, express or implied, for Festool portable power tools. This warranty policy is only valid for tools that are purchased in the US and Canada. Warranty policies of other countries may vary when obtaining warranty service outside the US and Canada. Some countries do exclude warranty for products bought outside their territory. Festool reserves the right to reject the repair of any tool that is not part of the US/Canada product line. No agent, representative, distributor, dealer, or employee of Festool has the authority to increase or otherwise change the obligations or limitations of this warranty.

---

## Repairs

If your Festool power tools require repair, you must contact our Service Department at 800-554-8741 (613-363-0169 Canada) for authorization and address details. To expedite the repair, please fill out and enclose the Repair Order Form. Download the form at [www.festoolusa.com](http://www.festoolusa.com) ([www.festoolcanada.com](http://www.festoolcanada.com)). No collect shipments will be accepted. No Festool hats, shirts or other wearables may be returned. Also contact our Service Department at the telephone number listed above if you have any questions about warranty claim procedures.

---

## Returns

If you need to return your Festool tools for any reason, please return it to the dealer from which you originally bought the tool.

use or misuse of this equipment. Festool assumes no liability for incidental, special, or consequential damage of any kind. Equipment specifications, applications, and options are subject to change at the sole discretion of Festool without notice.

Festool USA is a division of Tooltechnic Systems, LLC.

Festool is a trademark and service mark of TTS Tooltechnic Systems AG & Co. KG

Plug-It and Systainer are registered trademarks of TTS Tooltechnic Systems AG & Co. KG

[www.festoolusa.com](http://www.festoolusa.com)

# Contents

<b>About This Manual</b> .....	<b>3</b>	<b>Operation</b> .....	<b>12</b>
Tool Symbols .....	3	Setting the Blade Depth .....	12
<b>General Power Tool Safety Warnings</b> .....	<b>4</b>	Setting the Bevel Angle.....	13
Work Area Safety .....	4	Setting the Motor Speed .....	13
Electrical Safety .....	4	Using the Limit Stop .....	14
Personal Safety .....	4	Using Dust Extraction .....	14
Power Tool Use and Care .....	4	Connecting the Plug-it Cord .....	15
Service .....	5	Turning on the Saw .....	15
Specific Safety Rules for Circular Saws.....	5	<b>Applications</b> .....	<b>16</b>
Causes and Prevention of Kickback.....	5	Straight-Lining Rough Lumber .....	16
Respiratory Exposure Safety Warnings .....	5	Crosscutting and Trimming .....	17
<b>Functional Description</b> .....	<b>6</b>	Plunge Cutting .....	18
Intended Use.....	7	Cutting Non-Wood Materials .....	19
Technical Specifications.....	7	Soft Plastics.....	19
<b>Setup</b> .....	<b>7</b>	Brittle Plastics .....	19
Setting Up a New Saw .....	7	Thin Aluminum.....	19
Adjusting the Guide Rail Cams .....	7	Extruded Aluminum .....	19
Trimming the Guide Rail Splinter Guard.....	8	<b>Maintenance</b> .....	<b>20</b>
Installing the Outrigger Splinter Guard.....	8	Routine Maintenance .....	20
Changing the Sawblade .....	9	Replacing the Guide Rail Splinter Guard .....	21
Sawblade Selection .....	10	Changing the Motor Brushes.....	21
Tooth Shape .....	10	Adjustments.....	22
Number of Teeth and Spacing.....	10	Matching Multiple Saws to Shared Guide Rails .	22
Hook Angle .....	10	Installing the Imperial Depth Gauge.....	23
TS 55 REQ Sawblades .....	10	<b>Troubleshooting</b> .....	<b>24</b>
Guide Rails.....	11		
Tips for Choosing Guide Rail Lengths.....	11		
Joining Rails.....	11		

## About This Manual

### Save These Instructions

It is important for you to read and understand this manual. The information it contains relates to protecting YOUR SAFETY and PREVENTING PROBLEMS. The symbols below are used to help you recognize this information.



**WARNING!** Indicates a potentially hazardous situation which, if not avoided, could result in death or serious injury.



**CAUTION!** Indicates a potentially hazardous situation which, if not avoided, could result in minor or moderate injury.



**NOTICE:** Indicates a potential situation which, if not avoided, can result in property damage or damage to the tool.



**Note:** Indicates information, notes, or tips for improving your success using the tool.

### Tool Symbols

V	Volts
W	Watts
Hz	Hertz
~	Alternating Current (AC)
n <sub>o</sub>	No-load Speed
∅	Diameter
⊠	Class II Double Insulated

# General Power Tool Safety Warnings



**WARNING! Read all safety warnings and instructions.** Failure to follow the warnings and instructions may result in electric shock, fire, and/or serious injury.

**Save all warnings and instructions for future reference.**

## Work Area Safety

- ▶ Keep your work area clean and well lit. Cluttered or dark work areas invite accidents.
- ▶ Do not operate power tools in explosive atmospheres, such as in the presence of flammable liquids, gases, or dust. Power tools create sparks which may ignite the dust or fumes.
- ▶ Keep children and bystanders away while operating a power tool. Distractions can cause you to lose control.

## Electrical Safety

- ▶ Power tool plugs must match the outlet. Never modify the plug in any way. Do not use any adapter plugs with earthed (grounded) power tools. Unmodified plugs and matching outlets will reduce risk of electric shock.
- ▶ Avoid body contact with earthed or grounded surfaces such as pipes, radiators, ranges and refrigerators. There is an increased risk of electric shock if your body is earthed or grounded.
- ▶ Do not expose power tools to rain or wet conditions. Water entering a power tool will increase the risk of electric shock.
- ▶ Do not abuse the cord. Never use the cord for carrying, pulling, or unplugging the power tool. Keep cord away from heat, oil, sharp edges or moving parts. Damaged or entangled cords increase the risk of electric shock.
- ▶ When operating a power tool outdoors, use an extension cord suitable for outdoor use. Use of a cord for outdoor use reduces the risk of electric shock.
- ▶ If operating a power tool in a damp location is unavoidable, use a ground fault circuit interrupter (GFCI) protected supply. Use of a GFCI reduces the risk of electric shock.
- ▶ Never use an extension cord that is damaged, including cuts, exposed wires, or bent/missing prongs. Damaged extension cords increase the risk of fire or electric shock.
- ▶ Use only extension cords rated for the purpose.
- ▶ Use only extension cords rated for the amperage of this tool and the length of the cord. Using too small of an extension cord can cause the cord to overheat.

### Extension Cord Ratings

Cord Length	Size (AWG)
<50 Ft.	14
50-100 Ft.	12
>100 Ft.	Not recommended

## Personal Safety

- ▶ Stay alert, watch what you are doing, and use common sense when operating a power tool. Do not use a power tool while tired or under the influence of drugs, alcohol, or medication. A moment of inattention while operating power tools may result in serious personal injury.
- ▶ Use personal protective equipment. Always wear eye protection. Protective equipment such as dust mask, non-skid safety shoes, hard hat, or hearing protection used for appropriate conditions will reduce personal injuries.
- ▶ Prevent unintentional starting. Ensure the switch is in the off-position before connecting to power source, picking up, or carrying the tool. Carrying power tools with your finger on the switch or energizing power tools that have the switch on invites accidents.
- ▶ Remove adjusting key or wrench before turning the power tool on. A wrench or a key that is left attached to a rotating part of the tool may result in personal injury.
- ▶ Do not overreach. Keep proper footing and balance at all times. This enables better control of the tool in unexpected situations.
- ▶ Dress properly. Do not wear loose clothing or jewelry. Keep your hair, clothing, and gloves away from moving parts. Loose clothes, jewelry, or long hair can be caught in moving parts.
- ▶ If devices are provided for the connection of dust extraction and collection facilities, ensure these are connected and properly used. Use of dust collection can reduce dust-related hazards.
- ▶ Always wear safety glasses complying with ANSI Z87.1. Ordinary glasses are not proper protection.

## Power Tool Use and Care

- ▶ Do not force the power tool. Use the correct power tool for your application. The correct power tool will do the job better and safer at the rate for which it is designed.
- ▶ Do not use the power tool if the switch does not turn it on and off. Any power tool that cannot be controlled with the switch is dangerous and must be repaired.
- ▶ Disconnect the plug from the power source before making any adjustments, changing accessories, or storing the tool. Such preventive safety measures reduce the risk of starting the tool accidentally.
- ▶ Store idle tools out of reach of children and do not allow persons unfamiliar with the power tool or these instructions to operate the power tool. Power tools are dangerous in the hands of untrained users.
- ▶ Maintain power tools. Check for misalignment or binding of moving parts, breakage of parts and any other condition that may affect the power tool's operation. If damaged, have the power tool repaired before use. Many accidents are caused by poorly maintained power tools.
- ▶ Keep cutting tools sharp and clean. Properly maintained tools with sharp cutting edges are less likely to bind and are easier to control.
- ▶ Use the power tool, accessories, and tool bits etc. in accordance with these instructions, taking into account the working

conditions and the work to be performed. Use of the power tool for operations different from those intended could result in a hazardous situation.

- ▶ To reduce the risk of serious injury, never alter or misuse the power tool.

---

## Service

- ▶ Have your power tool serviced by a qualified repair person using only identical replacement parts. This will ensure that

the safety of the power tool is maintained.

---

## Specific Safety Rules for Circular Saws

- ▶ Keep hands away from the blade and cutting area. Keep your second hand on the auxiliary handle. If both hands are holding the saw, they cannot be cut by the blade.
- ▶ Keep your body positioned to either side of the saw blade, but not in line with the saw blade. Kickback could cause the saw to jump backward. (See "Causes and Prevention of Kickback" below.)
- ▶ Do not reach underneath the workpiece. The blade is fully exposed under the workpiece.
- ▶ Never use a plunging circular saw that fails to return to its unplunged position. If the saw ever fails to fully retract the sawblade as expected, immediately stop using the saw and have the saw serviced by an authorized service center.
- ▶ Never use a dust extraction system when making cuts that can result in sparks, such as cutting through nails and other ferrous materials. Sparks and hot embers can cause a fire or explosion in the dust extraction system.
- ▶ Never hold the piece being cut in your hands or across your leg. It is important to support the work properly to minimize body exposure, blade binding, or loss of control.
- ▶ Hold the saw by the insulated handles when performing an operation in which the sawblade may contact hidden wiring or its own cord. Contact with a "live" wire will make the exposed metal parts of the tool "live" and shock the operator.
- ▶ When ripping, always use a rip fence or straight edge guide. This improves the accuracy of cut and reduces the chance for blade binding.
- ▶ Always use blades with the correct size and shape arbor holes. Blades that do not match the mounting hardware of the saw will run eccentrically, causing loss of control.
- ▶ Never use damaged or incorrect blade flanges or bolt. The blade flanges and bolt were specially designed for your saw for optimum performance and safety of operation.

---

## Causes and Prevention of Kickback

Kickback is a sudden reaction to a pinched, bound, or misaligned saw blade that causes the saw to lift up and out of the workpiece toward the operator.

Chances for kickback may be reduced by taking proper precautions as described below:

- ▶ Maintain a firm grip with both hands on the saw and position your body and arm to allow you to resist kickback forces. Kickback forces can be controlled by the operator if proper precautions are taken.
- ▶ When interrupting a cut for any reason, release the trigger and hold the saw motionless in the material until the blade comes to a complete stop. Never attempt to remove the saw from the work or pull the saw backward while the blade is in motion, or kickback may occur.
- ▶ When restarting a saw in the workpiece, center the saw blade in the kerf and check that the saw teeth are not engaging the

material. If the saw blade is binding during a restart, it may climb up or kickback from the workpiece.

- ▶ Do not use a dull or damaged blade. Dull or improperly sharpened blades cause excessive friction, blade binding, and kickback.
- ▶ Support large panels to minimize the risk of the blade pinching and causing a kickback. Large panels tend to sag under their own weight. Supports must be placed under the panel on both sides, near the line of cut and near the edge of the panel.
- ▶ The bevel adjusting knobs must be fully tightened before making a cut. If the blade tilts during a cut, it will bind and cause a kickback.
- ▶ Use extra caution when making a plunge cut into existing walls or other blind areas. The protruding blade may cut objects that can cause kickback.

---

## Respiratory Exposure Safety Warnings

Substantial or repeated inhalation of dust and other airborne contaminants, in particular those with a smaller particle size, may cause respiratory or other illnesses. Various dusts created by power sanding, sawing, grinding, drilling and other construction activities contain chemicals or substances known (to the State of California and others) to cause cancer, birth defects or other reproductive harm. Some examples of these chemicals/substances are: lead from lead-based paints; crystalline silica from bricks, cement, and other masonry products; arsenic and chromium from chemically-treated lumber; and some wood

dusts, especially from hardwoods, but also from some softwoods such as Western Red Cedar.

The risk from these exposures varies, depending on how often you do this type of work. To reduce your exposure to these chemicals: work in a well ventilated area and use a properly functioning dust extraction system. When the inhalation of dust cannot be substantially controlled, i.e., kept at or near the ambient (background) level, the operator and any bystanders should wear a respirator approved by NIOSH for the type of dust encountered.

# Functional Description



Item	Name or Description	Ref. Page(s)
A	Viewing Window	8
B	Arbor Bolt	9
C	Spring Loaded Riving Knife	--
D	Miter Release Button	13
E	Dust Collection Port	14
F	Plunge/Trigger Release	15
G	FastFix Arbor/Plunge Lock	9
H	Trigger (On/Off Switch)	15
I	Auxiliary Handle	--
J	Blade Wrench Storage	9

Item	Name or Description	Ref. Page(s)
K	Depth Stop and Gauge	12,23
L	Bevel Gauge and Lock Knob	13
M	Speed Control	13
N	Plug-It Power Cord Port	15
O	Guide Rail Cams	7,8
P	Sole Plate	--
Q	Outrigger Splinter Guard	8,18
R	Limit Stop	14,18
S	Main Handle	--

## Intended Use

The TS 55 REQ, hand-operated circular saw, is designed exclusively for sawing of wood, wood-like materials, and plastics. The saw may also be used for cutting aluminum when a Festool aluminum-cutting sawblade is installed. The tool should not be altered or used for any other purpose,

other than as specified in these operating instructions. Using the tool in contravention to this manual will void your warranty and may lead to injury. The user shall be responsible and liable for damages and accidents resulting from misuse or abuse of this saw.

## Technical Specifications

Power Consumption	1200 Watts (10 amps @ 120 volts)
Speed Range	2,000 to 5,200 RPM (no load)
Blade Diameter	160 mm
Arbor Diameter	20 mm, Round
Depth of Cut (without guide rail)	55 mm (2.2") @ 90°, 43 mm (1.7") @ 45°
Bevel Angle	0° to 45°, plus -1° to 47°
Weight	4.5 kg (9.9 lbs)

## Setup

### Setting Up a New Saw

There are some simple setup procedures to follow before a new saw can be used. Follow this sequence of inspections and adjustments before using the saw for the first time. It is important that these instructions be followed sequentially before cutting the zero-clearance splinter guards.



**WARNING!** Always disconnect the saw from the power supply before making any adjustments to the saw or installing or removing any accessory.



**CAUTION!** Check regularly whether the saw blade is in good condition, and the arbor bolt is firmly tightened. Saw blades which are cracked, damaged, or deformed should no longer be used.

1. With the saw unplugged, inspect the blade for damage and make sure it is properly secured to the arbor. (Refer to "Changing the Sawblade" on page 9 for more information).
2. Perform the guide rail gib cam adjustment procedure described below.
3. Install the power cord into the Plug-It receptacle on the saw (refer to page 15 for more information).
4. After completing all of the inspections and adjustments listed above, cut the zero-clearance splinter guards as described on page 8.

### Adjusting the Guide Rail Cams

The guide rail cams tighten against the rib of the guide rail to remove any side-play from the saw during a cut. Knobs on the top of the cams permit easy adjustment.

1. Place the saw on the guide rail.
2. Loosen both cams by rotating the knobs counterclockwise.
3. Working with one cam at a time, jiggle the saw side-to-side while turning the cam clockwise until the saw fits snugly to the rail.
4. Repeat for the second cam.
5. Make sure the cams are not over tightened by sliding the saw down the guide rail. If the saw does not slide easily, loosen the cams.

#### Notes:

- ▶ The cams do not need to be very tight for normal operations. A tiny amount of side-play will not impact the quality of a cut.
- ▶ Over tightening the cams or operating the saw in abrasive environments can cause premature wear of the wear bars. Periodically inspect the wear bars for flat spots, and replace if necessary.

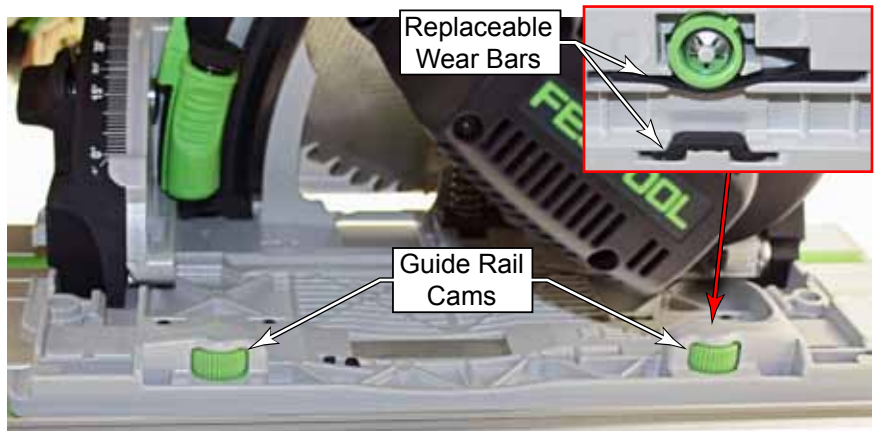

## Trimming the Guide Rail Splinter Guard

The leading edge of the guide rail has a replaceable, rubber, zero-clearance strip. The first time the saw is used with the guide rail, this strip is trimmed to match the sawblade. When trimmed to size, this strip reduces chipping and tearout during normal cutting.

**i Important:** If you have more than one saw that uses the same guide rail system, you want all of the saws to have the same cutting path. Before cutting the splinter guard, use the "[Matching Multiple Saws to Shared Guide Rails](#)" on page 22 to match one saw to another before completing this procedure.

1. Set the blade depth very shallow (6 to 7 mm) so that the blade teeth penetrate the strip by about half a tooth, as shown.

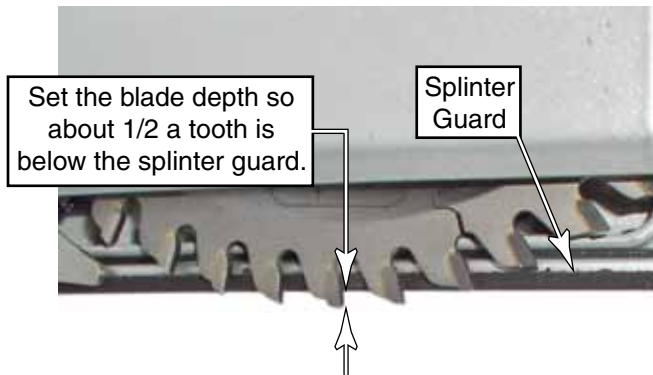

2. Set the motor speed to 6.
3. Place the guide rail on a stable surface with the strip hanging over the edge so you don't cut the table.
4. If necessary, adjust the guide rail cams as described on [page 7](#).
5. Cut the strip in a single, smooth, low-speed rip from one end of the guide rail to the other.



## Installing the Outrigger Splinter Guard

The outrigger splinter guard is used to prevent chipping on the offcut side of the sawblade. The outrigger can be retracted away from the workpiece when not needed.

**i Note:** The outrigger splinter guard is a consumable item and will need to be replaced periodically when it is no longer close to the blade.

**i Note:** The first time you use the outrigger splinter guard, it will be trimmed to match the blade.

1. Remove the clear viewing window by pushing straight down and sliding it out of the saw.
2. Remove the thumbscrew from the outrigger and slide the outrigger on to the front edge of the blade guard as shown.
3. Insert the thumbscrew through the outrigger, through the height adjustment slot, and into the captive nut on the back side of the outrigger.
4. Place the guiderail on the workpiece and the saw on the guiderail.
5. Press down on the outrigger splinter guard so it is lightly touching the workpiece, and tighten the thumbscrew.

6. For longer life, remove the splinter guard and reinstall the clear viewing window, when not in use.

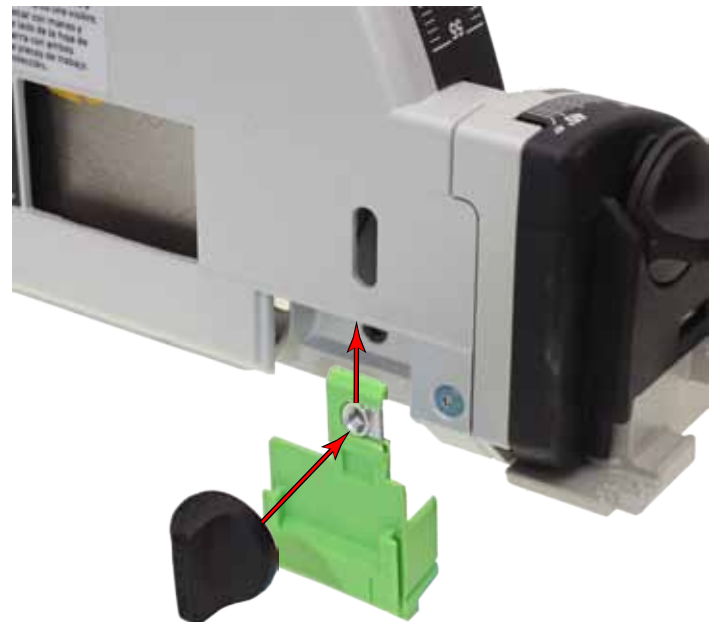



## Changing the Sawblade

The TS55 saw features the FastFix system for easier blade changing. The FastFix system is engaged by raising the FastFix lever and plunging the saw down. The system includes the following features:

- ▶ For safety, the power switch is locked out.
- ▶ The plunge depth is locked in the position shown to the right with the arbor bolt accessible through an opening in the blade cover.
- ▶ The arbor is locked from turning.

### Sawblade Checks and Warnings

- ▶ Use only sawblades that are approved for use with the saw and appropriate for the type of material being cut.
- ▶ Use only sawblades with a diameter of 160 mm, and an arbor bore of 20 mm.
- ▶ Do not use a sawblade that is bent or warped.
- ▶ Do not use a sawblade with missing or damaged teeth.

### Removing the Sawblade

1. Unplug the saw for safety.
2. Although not required, you may wish to remove the outrigger splinter guard for better clearance.
3. Set the blade depth gauge to at least 25 mm, or below.
4. Raise the FastFix latch lever.
5. Press upward on the plunge lock release button and plunge the saw down until it locks into position.
6. Using the arbor wrench (stored in the auxiliary handle) loosen the arbor bolt by turning it counterclockwise.
7. Remove the arbor bolt and flange.

**i Hint:** If you drop the arbor flange inside the blade guard, remove the blade and the arbor flange should come out afterward.

8. Lift the blade off the inboard arbor flange, and slide the blade out of the blade guard over the top of the riving knife.

### Replacing the Sawblade

Festool offers a variety of sawblades for the many types of cuts the saw can be used for. These range from fine cross-cutting, ripping, and even a plastic and metal cutting blade. Refer to "[Sawblade Selection](#)" on page 10 for information on which blade may be best suited for the desired task.

1. Make sure the blade's label is facing outward, and the teeth are facing forward in the direction shown above.
2. Insert the blade into the housing, over the top of the riving knife, and onto the arbor.
3. Make sure the blade is properly seated on the inboard arbor flange.

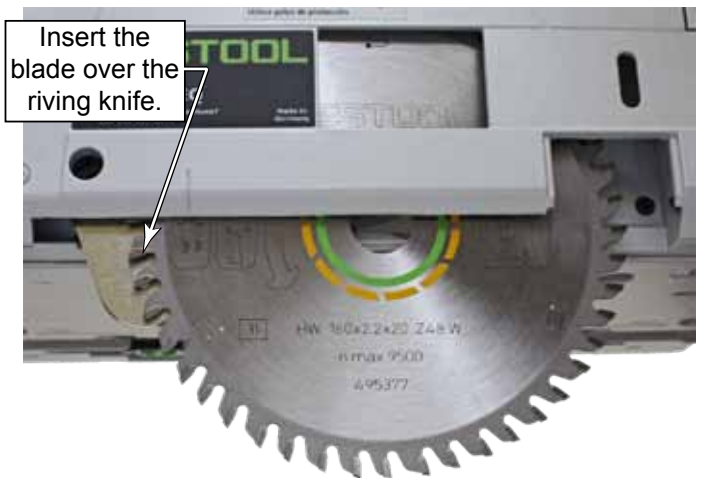
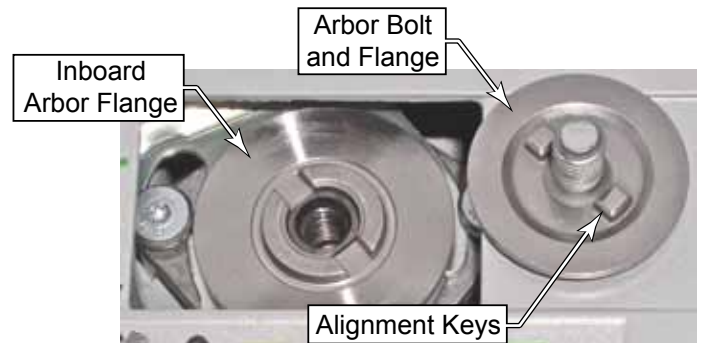

4. Install the arbor flange with the alignment keys aligned with the notches in the inboard arbor flange.
5. Firmly tighten the arbor bolt.



**CAUTION!** The arbor bolt is not a self-tightening type if left too loose. Periodically check to ensure it is firmly tightened.

## Sawblade Selection

Festool sawblades are designed for optimal performance in a variety of applications. Choosing the correct sawblade is important for obtaining the best cuts and optimal blade life. There are several factors that determine which blades are best suited for the operation.

### Tooth Shape

Festool sawblades come in two primary tooth shapes. The Alternate Top Bevel (ATB) shape is ideal for clean cutting of wood fibers. The Triple Chip (TC) shape is very robust in holding sharpness in hard or abrasive materials.

The alternating points of the ATB blade slice through the wood fibers at the edges of the cut to produce clean and efficient cuts. The lower 15° bevel angle of Festool blades allow them to maintain sharpness of the points longer between sharpenings.

The trapezoidal shape of the TC blade tooth maintains its sharpness by not having points that could quickly dull. Each trapezoidal tooth initially cuts a little of the center of the cut, and then is followed by a flat-top raker tooth to finish the cut and clean up the corners. The TC grind is ideally suited for materials that would otherwise quickly dull an ATB blade.

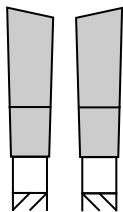

ATB

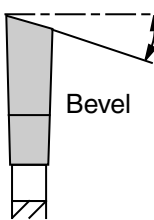

Bevel

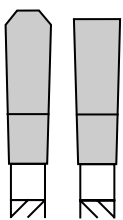

TCG

### Number of Teeth and Spacing

The more teeth a blade has, the less work each tooth has to do by itself. This results in cleaner cuts in fibrous materials such as wood. It also makes the blade less aggressive in its cutting, which is beneficial in both hard materials and fibrous materials.

Another aspect about tooth spacing is harmonics. If each successive tooth strikes the workpiece in rhythm with other teeth, it can set up vibrations in the blade and workpiece. Festool sawblades use variable tooth spacing to prevent harmonics from happening. The spacing between successive teeth is constantly changing so that the frequency of successive cuts is never in a harmful rhythm.

### Hook Angle

The hook angle of a sawblade is the angle between the face of a blade tooth with respect to a radial line to the center of the blade. This is most obvious on ripping blades, where the high hook angle is easily seen. The higher the hook angle, the more aggressive the blade will cut the workpiece. This is desired for ripping, but it is not desired for finer cuts, and especially not for very hard materials.

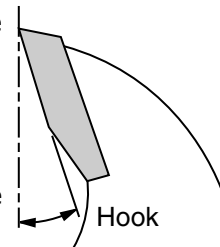

Hook

Cutting harder materials is best performed with blades with lower hook angles. Metal cutting blades (and miter saw blades) actually have negative hook angles to minimize their aggressiveness in the cut. This means that the teeth are sloped slightly backward from the radial line to the center of the blade.

## TS 55 REQ Sawblades

	<p><b>Fine Crosscut:</b> 48T, ATB, 12° hook</p> <p>This is the standard blade that comes with the TS55 saw. The high tooth count, low hook angle, and ATB design make it optimally suited for cutting veneered plywood with minimal tearout.</p>		<p><b>Ripping:</b> 14T, ATB, 37° hook</p> <p>The high hook angle of the Panther blade makes for effortless ripping without burning the cut.</p>
	<p><b>Combination:</b> 28T, ATB, 15° hook</p> <p>This blade combines the geometries of both ripping and crosscut blades. The higher hook angle makes it cut more aggressive like a ripping blade, and the moderate tooth count provides a cleaner cut like a crosscut blade.</p>		<p><b>Fine Laminate:</b> 48T, TC, 4° hook</p> <p>The ultra-hard TCG teeth on this blade provide chip-free cutting of laminates and solid surface materials without dulling.</p>
	<p><b>General Purpose:</b> 12T, ATB, 20° hook</p> <p>With a low tooth count and a high hook angle, this blade easily cuts through general construction materials.</p>		<p><b>Aluminum/Plastic:</b> 56T, TC, -5° hook</p> <p>The negative hook angle and high TCG tooth count of this blade provides grab-free control for cutting aluminum and hard plastic.</p>

## Guide Rails

Guide rails come in a variety of lengths, ranging from 32 inches to 197 inches (800mm to 5000mm). It is always best to use the correct length rail for the cut, but sometimes it is necessary to join two smaller rails together to make a longer rail. Guide rail connecting bars are available for joining two or more guide rails together.

### Tips for Choosing Guide Rail Lengths

The length of the guide rail must be at least 10 inches (250mm) longer than the cut to be performed. This is so that the saw can be supported (and guided) at both the beginning and end of the cut. The minimum position is when the guide rail cam (page 7) is at the edge of the rail, but still on the rail.

- ▶ The guide rail must extend at least 6 to 7 inches (depending on blade depth) ahead of the cut to allow the sawblade to be plunged without entering the workpiece.
- ▶ The guide rail must extend at least 3 inches past the cut to allow the center of the blade to exit the workpiece.

To simplify storage or transportation, some woodworkers prefer having two shorter rails instead of a longer rail. Other woodworkers prefer to have single lengths for the specific cuts they make, to minimize the frequency of needing to join rails. Here are some tips about choosing guide rail lengths to suit your needs:

- ▶ For frequent cutting of plywood sheets that involve both ripping and crosscutting, dedicated guide rails of the appropriate length may be best. This allows for switching back and forth quickly without having to join rails.
- ▶ It's more efficient to have guide rails of different lengths than it is to have two guide rails of the same length. This gives you more variety in lengths. For example, if you had two 55 inch rails, you would have only two possible combinations: 55 and 110 inches. However, if you had lengths of 42 and 75 inches, for example, you would have three combinations of lengths: 42, 75, and 117 inches.

- ▶ Shorter guide rails are easier to work with for shorter cuts. A cabinetmaker, for example, may want dedicated shorter guide rails for crosscutting cabinet carcass components.

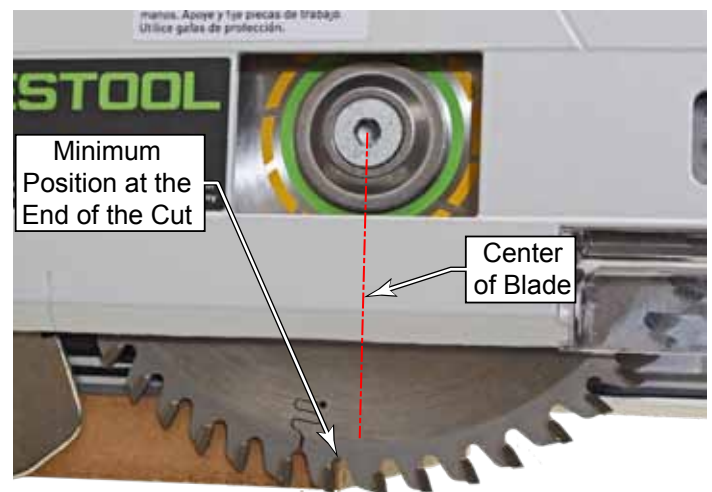
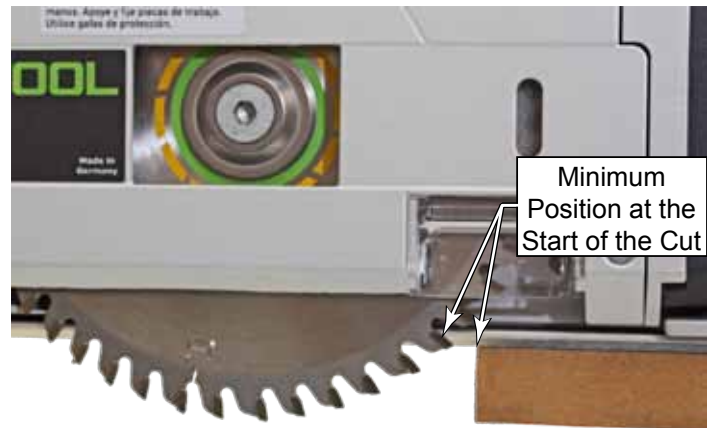

## Joining Rails

**i Note:** Do not assume that butting the two rail ends together will result in a straight line for their entire length. A very tiny error in the butted joint can result in a significant error across the length of the joined rails. A long straightedge is the recommended method for aligning the rails.

1. Insert the two connecting bars into the T-slots on one rail (typically the longer of the two rails). Make sure the clamping screws are facing outward.
2. Slide the second rail over the connecting bars and push the two rails together.
3. Place a straightedge across the joint between the two rails, as shown to the right.
4. Center the top connecting bar across the joint, and gently tighten the 4 clamping screws. Do not over tighten the screws, or you may dimple the guide rail.
5. Carefully flip the guide rails over, and with the straightedge across the joint, tighten the bottom clamping screws.

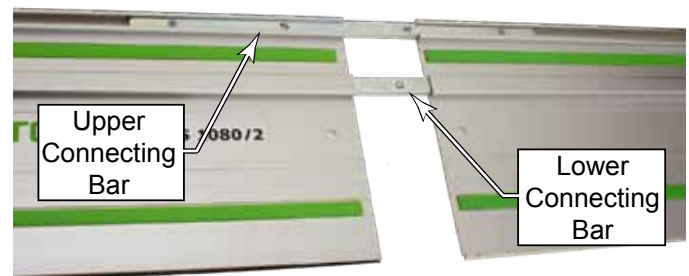

# Operation

## Setting the Blade Depth

The TS55 is equipped with a depth stop for setting the depth of the blade during a plunge cut. Using the correct blade depth improves cutting safety, cut quality, and motor efficiency.

### Multi-Function Tables

When the saw is used in conjunction with a Multi-Function Table (MFT), the blade depth is typically limited to be 2mm deeper than the thickness of the workpiece. This limits the amount that the blade cuts into the table.

### Off-table Cutting

When the saw is used for off-table cutting, the blade can be set deeper without cutting into the worktable. The following guidelines can be used to determine the optimal blade depth.

#### Effects of Too Shallow of a Setting

- ▶ Higher drag on the sawblade, requiring more power and effort to complete the cut.
- ▶ Increased chance for kickback.
- ▶ Increased chipping and splintering on the underside of the cut, especially with melamine and veneers.
- ▶ Increased burning of the cut, especially in certain hardwoods like cherry and maple.
- ▶ With the exception of underside chipping, all of these effects are greatest with finer-toothed blades.

#### Effects of Too Deep of a Setting

- ▶ Increased danger with more of the blade exposed below the workpiece.
- ▶ Increased sawtooth marks in the cut.
- ▶ Increased top-side chipping and splintering, especially without using the guide rail and splinter guards.

### Blade Depth Recommendations

There are no set rules for setting the depth of the blade with respect to the underside of the cut. However, a common industry guideline is to have the gullets of the blade even with the underside of the workpiece. This will therefore be used as a baseline to describe optional depth settings.

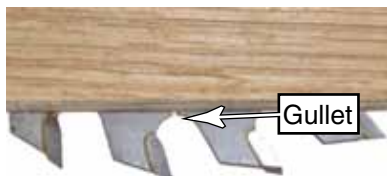

- ▶ If a material is prone to burning in the cut, increase the depth slightly. This includes ripping hardwoods such as cherry and maple.
- ▶ Using a combination blade in solid wood may perform better with a slightly deeper setting.
- ▶ Using a coarse blade in sheet materials may be improved

with a shallower cut.

- ▶ Cutting dense and/or hard materials may require a deeper setting to decrease heat and load on the tool.
- ▶ Cutting fragile or shatter-prone materials such as plastics or countertop laminates is best with a shallow setting (and low speed).
- ▶ Cutting aluminum may be improved with a semi-shallow setting, but not too shallow.
- ▶ When Used with the Multi-Function Table (MFT) you may wish to keep the blade depth shallower.
- ▶ Cutting non-fragile, non-shattering plastics such as polypropylene or solid-surface countertops may be improved with a deeper cut.
- ▶ More aggressive blades, such as the Panther ripping blade, can be used at a shallower setting.

### Using the Depth Stop

The depth stop has two index pointers 5mm apart. One is used to indicate the blade depth when used without a guide rail, and the other is used to indicate the blade depth when used with a guide rail.

The TS 55 REQ also includes an optional imperial (inch) depth gauge sticker. Refer to "[Installing the Imperial Depth Gauge](#)" on page 23 for instructions on installing the sticker.

- ▶ To change the depth setting, press in on the index pointer and slide it up or down to the desired setting.
- ▶ When precise depth control is needed, rotate the fine adjustment screw using the blade wrench. This is typically needed only when making trenching cuts.

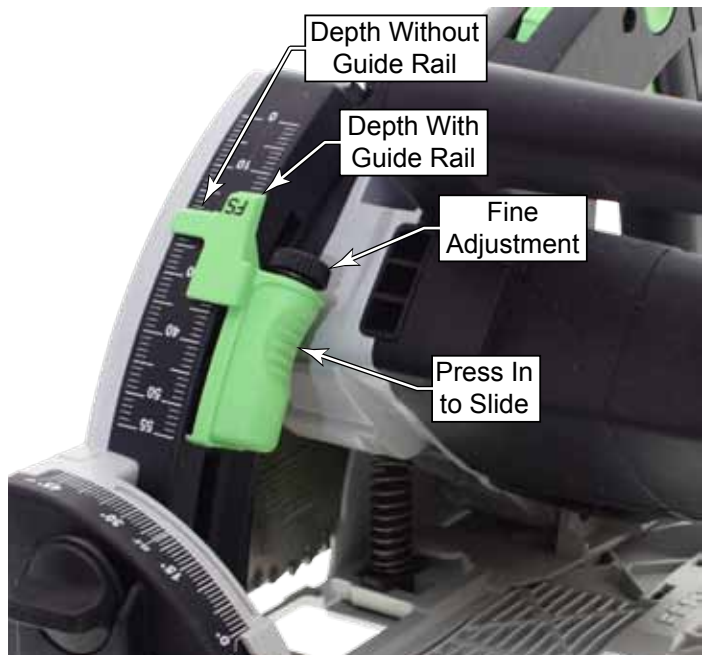

## Setting the Bevel Angle

The standard bevel range of the TS 55 REQ is between 0° and 45°. However, an extended range is also available from -1° to 47°. The extended range is available by pulling out on the limit release knob.

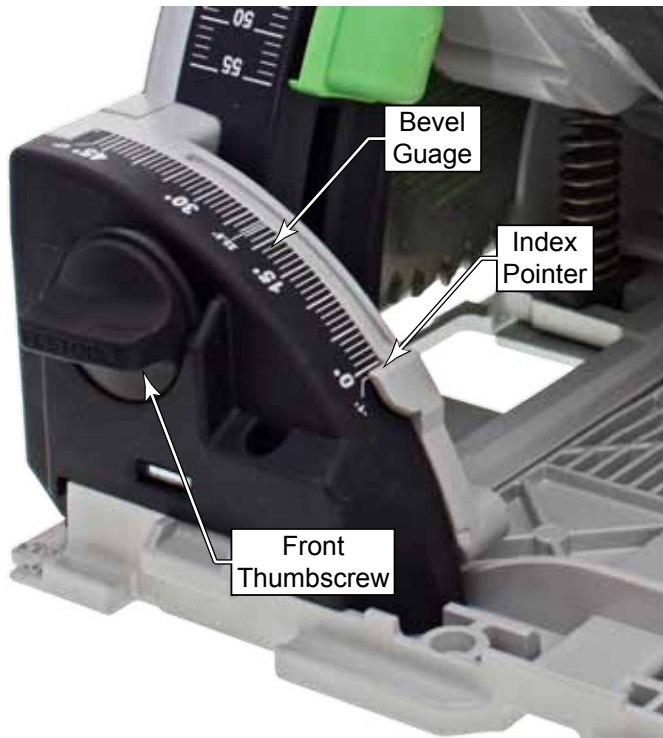

1. Loosen the front and rear bevel thumbscrews.
2. Tilt the saw until the index pointer is aligned with the desired angle. To go above or below the normal limit stops, pull out slightly on the limit release knob.
3. Retighten both bevel thumbscrews.

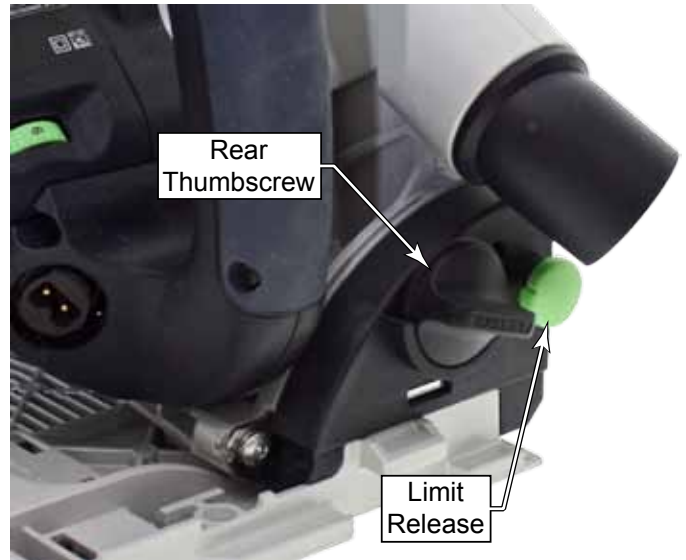

## Setting the Motor Speed

The TS55 has electronic speed control with soft-start circuitry. The electronic controller will maintain the motor speed even as the load changes. The speed control is infinitely variable from 2000 to 5200 RPM. The optimal speed of the saw is predominately determined by the type of material being cut.

Turn the speed control dial to the number shown in the table below.

Material	Speed
Soft wood products and veneer plywoods	6
Hardwood products	3-6
Plastic laminate countertops	6
Hard plastics	3-5
Soft plastics	1-4
Plaster and cementitious hardboard	1-3
Aluminum	4-6



## Using the Limit Stop

The limit stop serves two purposes: it controls the saw's starting position and prevents a kickback during a plunge cut. The leading edge of the limit stop prevents the saw from lifting up at the beginning of a plunge cut. This is what prevents kickback during a plunging operation. Refer to "Plunge Cutting" on page 18 for more information.

1. Slide the limit stop onto the T-slot of the guide rail behind the saw, and with the embossed arrow pointing toward the saw.
2. Position the stop behind the starting position of the saw.
  - ▶ When the blade is at full-depth, the limit stop is  $3\frac{3}{4}$  inches behind the start of the cut.
  - ▶ When the blade is less than full depth, the distance between the blade (cut) and the limit stop will be greater.
  - ▶ For best results, you should always verify the blade's cutting position before starting the cut.
3. Tighten the thumbscrew on the limit stop.



## Using Dust Extraction

The TS55 can be used with or without a dust extraction system. The chip diverter swivels to direct the sawdust away from the work area when a dust extraction system is not used.

For best results, however, a dust extraction system (such as the Festool CT 22 shown below) should be used. Festool dust extractors have the added features of variable speed, and sensing when the saw is turned on. The vacuum will automatically start when the saw is turned on, and will remain running for a couple of seconds after the saw turns off to clear the remaining dust.

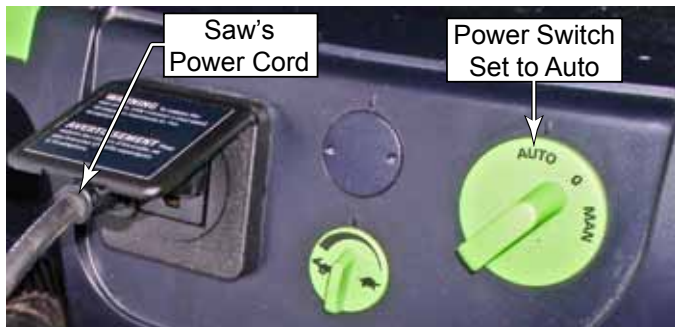

1. Insert the extractor hose on to the chip diverter.
  - ▶ The 27mm Festool hose fits inside the diverter, and the 36mm Festool hose fits over the diverter.
  - ▶ The diverter ID is 35mm ( $1\frac{3}{8}$ "), and the OD is 39mm ( $1\frac{9}{16}$ ").
2. Plug the TS 55 power cord into the auxiliary outlet on the extractor (if so equipped).
3. Set the power switch on the extractor to "Auto." (The auxiliary power outlet is active only when the switch is set to Auto.)



## Connecting the Plug-it Cord

The TS55 saw comes equipped with a removable Plug-It power cord. To install the power cord, insert the cord into the inlet on the tool with the key and keyway aligned, and twist the locking ring. Reverse the procedure to remove the cord.

 **NOTICE:** Make sure to fully tighten the plug-it cord a full quarter-turn until it clicks. If the plug is not fully locked, the socket and cord can overheat and be damaged.

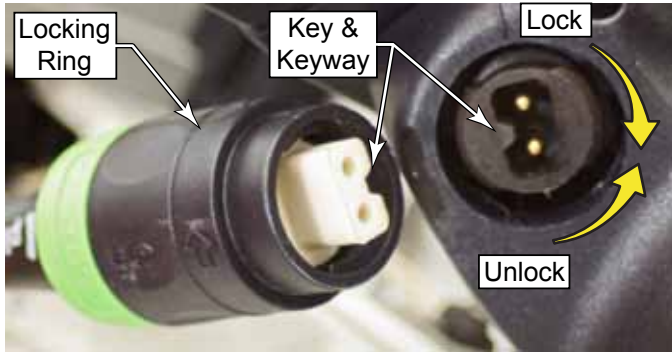

## Turning on the Saw

To prevent unexpected start-ups, the power switch has an integral safety interlock. Before the saw can be started or plunged, the plunge release must be engaged.

To start the saw, push up on the plunge release, and pull back on the trigger. Once the trigger has been engaged, you no longer need to hold the plunge release raised.



### A Note About Motor Sound

Most circular saws do not have variable speed electronic controls like the TS55 has. For this reason, many new saw owners aren't accustomed to the slight "growling" sound of the motor's gears when they first operate the saw. This sound is normal and not an indication that something is wrong with the tool.

The sound is the result of the gears interacting with the electronic speed control. The electronic controller in the motor controls the motor speed by turning it On and Off very rapidly. This form of speed control is called "Pulse Width Modulation" (PWM), and is common in most power tools with a variable speed control. When there is little or no load on the sawblade, the pulsations of the motor cause the gears to rapidly engage and disengage (called lash), and this is the sound you are hearing.

# Applications

The TS55 is capable of performing a wide variety of tasks. The following sections provide information on some of these tasks. This is intended to be an introduction to the capabili-

ties of the saw, but should not be considered as a comprehensive list of its capabilities.

## Straight-Lining Rough Lumber

Purchasing lumber directly from a saw mill is significantly less expensive than buying from a home center. However, part of the reason why the lumber is less expensive is because it frequently has not been straight-line ripped.

Sawmills have special straight-line ripping tablesaws, but they charge an extra fee for the service, and straight-lining on a regular tablesaw is complicated.

The TS55 can quickly and easily straight-line rough lumber using the guide rail. Additionally, if the grain of the wood is diagonal with the cut edge, the TS55 can be used to re-cut the lumber on a diagonal to match the natural wood grain direction or to avoid defects.

### Tips for Successful Straight-Lining

► Use the correct blade for the cut. The Panther ripping blade will provide the easiest cutting in any hardwood. A coarse combination blade may be used for softwoods, or for a finer edge, but it will take more effort to rip the wood.

- Choosing a blade depth: When ripping hardwood lumber, there is a trade off between cutting power and cutting quality. A deeper blade setting takes less energy, but a shallower blade setting typically leaves a finer cut.
- A dedicated ripping blade, such as the Panther, is aggressive enough in cutting power that it may be used with a shallow cutting depth.
- For a less aggressive combination blade, you may need to set the depth a little lower to reduce the power demand on the blade.
- Choose the orientation of the guide rail to optimize the board usage. This may have several different options:
  - Align the cut with the natural wood grain orientation.
  - Align the cut to avoid defects in the wood.
  - Align the cut to maximize board width, while eliminating curved edges.
- Place the board on sawhorses or elevate it from a work table so you do not cut into your work table.

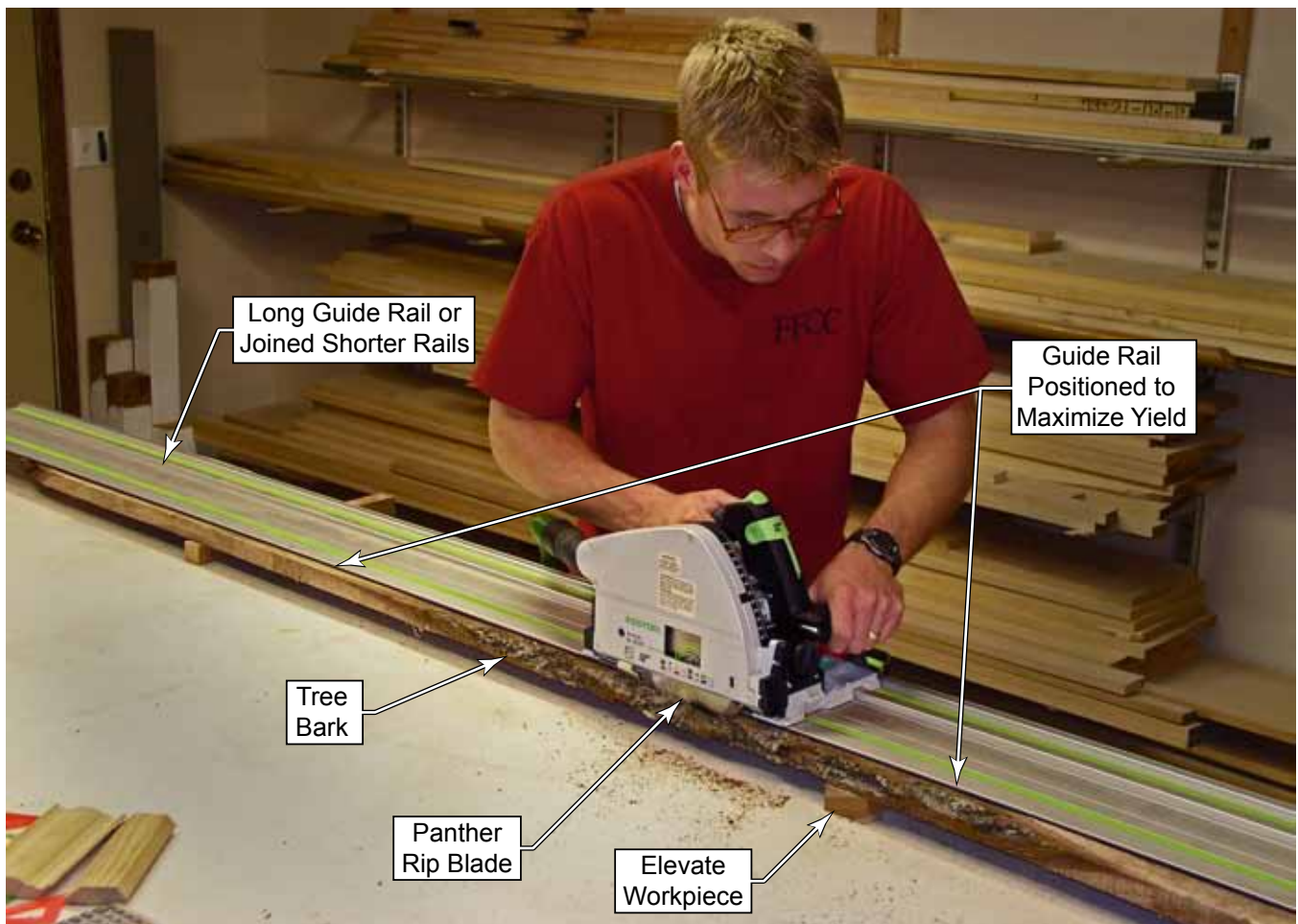



## Crosscutting and Trimming

No other saw on the market can outperform a Festool for splinter-free, fine crosscutting. With other saws, the problem is two-fold; getting a straight cut, and achieving a splinter-free cut. The TS55 handles these problems effortlessly.

### Tips for Successful Crosscutting

- ▶ Use the correct blade for the cut.
  - ▶ Crosscutting fine veneered wood should use the fine crosscut blade. The Alternate-Top-Bevel teeth will slice the wood fibers best, with virtually no chipping.
  - ▶ Crosscutting soft lumber, or lumber-core veneers should use the fine crosscut blade or the combination blade. With fewer teeth than the fine crosscut blade, the combination blade will be more aggressive for cutting, yet still provide good chip-free cutting.
  - ▶ Crosscutting thick hardwood lumber, and difficult to cut lumber should use the coarse crosscut blade. The coarse tooth-count of this blade provides very aggressive cutting of difficult material, but won't provide as smooth of a finish as the finer blades.
  - ▶ Cutting plastic-veneer countertops or solid surface materials should use the fine laminate blade. The Triple-Chip-Grind of this blade lasts longer in hard materials and reduces chipping in man-made materials. The triple-chip-grind will provide good cuts in wood veneers, but not as good as the alternate-top-bevel fine crosscut blade.
- ▶ For small offcuts, overhang the workpiece from a work table or saw horses (as shown below). For larger offcuts, support both the primary piece and the offcut.
- ▶ If the offcut is reusable, use the outrigger splinter guard to prevent chipping.
- ▶ Make sure the workpiece is secure. The lightweight door shown in the example below would slide on the table if not clamped down.
- ▶ Make sure the guide rail is secure if it can move during the cut. In the example below, starting the cut with the saw behind the workpiece can cause the guide rail to tip up and move. (The guide rail clamps are below the guide rail, and not visible.)
- ▶ Don't start the cut by plunging the saw into the wood, as this can lead to tearout at the bottom-back of the saw-blade. Start the cut with the blade down and behind the workpiece (as described on [page 11](#)), and advance the saw forward into the cut.
- ▶ Setting the blade depth too shallow (just barely penetrating the underside of the workpiece) can cause tearout on the underside of the cut.



## Plunge Cutting



**CAUTION!** Never make a plunge cut without a limit stop. The back of the sawblade will lift the saw off the guide rail, and will result in a kickback situation.

Plunge cutting is used when the cut does not start at the edge of the workpiece. Instead, it starts in the middle of the workpiece, and may continue to the end, or may stop short of the end. There is a wide variety of applications for plunge cuts. Some examples include cutting a countertop for a sink or appliance, cutting a hardwood floor for inset tile, slotting a cabinet frame for a pull-out bread board; just to name a few.

### Notes

- ▶ Always use the limit stop when making a plunge cut to prevent an unexpected kickback (see [page 14](#)).
- ▶ Whenever possible, put the guide rail on the side of the cut that will be saved. If the guide rail is placed on the offcut side, you must remember to account for the blade thickness when positioning the guide rail (typically 2.2 mm).
- ▶ Whenever possible, set the saw depth to its maximum setting to minimize the amount of material that is not cut by the blade. Make sure there is nothing below the cut that you don't want to cut into.

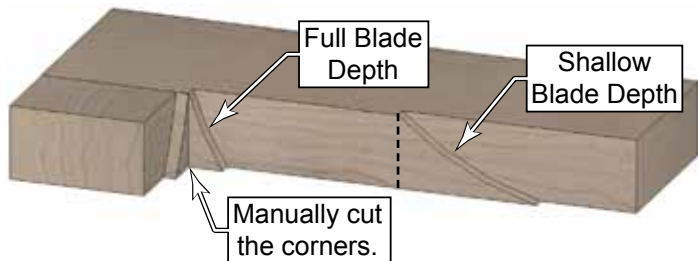

- ▶ Mark the beginning and end of the cut (blue tape in picture below). If the blade is at full depth, there are index marks on the saw that indicate where the blade is positioned.
- ▶ For 4-sided cuts where the center section is removed, support the offcut piece before cutting all four sides to prevent it from breaking the corners. Trim the corners with a handsaw.

- ▶ To control the position of the saw at both the beginning and end, you may use a second limit stop (part number 491582) at the front of the saw, as shown below.

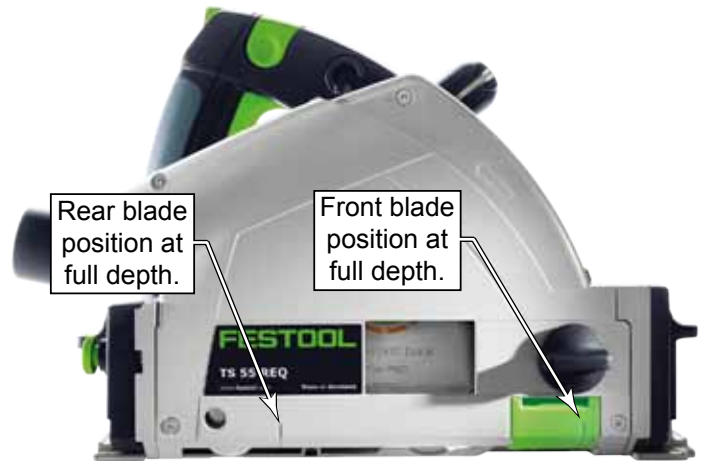

### General Procedure

1. Using pencil lines, tape, or some other means, mark the beginning and end of the cut.
2. Place the guide rail on the cutline.
3. Place the saw on the guide rail, and position it at the start of the cut.
4. Install the limit stop on the guide rail, slide it up to the back of the saw, and lock it in place.
5. If an optional second limit stop is used, set its position in a similar manner.
6. With the saw firmly seated against the beginning limit stop, start the saw and slowly plunge it down.
7. Advance the saw through the cut until the end is reached.
  - ▶ Hold the saw fully plunged until the blade comes to a complete stop.
  - ▶ Never back the saw up, as this can result in a kickback.



## Cutting Non-Wood Materials

### Soft Plastics

Soft plastics such as polypropylene won't chip, but they will melt. Therefore, a more aggressive cut with the blade set deeper and the motor speed set low will reduce the melting.

- ▶ Too shallow of a blade depth and the plastic will be more prone to melting.
- ▶ Too deep of a blade depth and the teeth marks from the blade will be more prevalent.
- ▶ Any of the fine-tooth blades with a slow motor speed will cut this material with good results.
- ▶ Clean up the cut edges with a cabinet scraper.



### Brittle Plastics

Brittle plastics will both melt and chip, so cutting them is problematic with most other saws. The TS55 works great for cutting this type of material.

- ▶ Set the blade depth very shallow to reduce chipping.
- ▶ Set the motor speed very low to reduce melting.
- ▶ Use any one of the finer tooth blades for good results, but the negative hook aluminum and plastic blade provides the best results.
- ▶ In clear plastics such as acrylic, if the cut is milky white, it is a sign of melting. Note how the cut to the right is transparent.



### Thin Aluminum

The problem with cutting thin aluminum sheet is that the blade teeth can catch the edge of the sheet, and cut more aggressively than expected. To reduce this, you want the teeth moving nearly parallel with the aluminum surface (a shallow blade depth).

- ▶ The ultra-thin aluminum shown in the example was cut best with the fine crosscut blade. The positive hook angle of the blade kept the flexible aluminum tight to the guide rail in a sheering cut.
- ▶ For slightly thicker, less flexible pieces of aluminum, the negative hook angle, aluminum cutting blade works best because it cuts less aggressively.



### Extruded Aluminum

Care needs to be taken when cutting extruded aluminum because the blade may cut more aggressively than expected on the various surfaces of the stock. This is most noticeable with thin-walled extrusions.

- ▶ With thin-walled extrusions, try to keep the blade teeth traveling parallel to the walls (see image above) to reduce aggressiveness.
- ▶ With thick-walled extrusions, try to keep the blade teeth traveling slightly more perpendicular to the walls (see image to the right) to decrease loading.
- ▶ Use the negative hook angle, aluminum-cutting blade, and a moderate to high speed setting.
- ▶ Be prepared for the blade to catch unexpectedly as the cutting angle changes with each facet of the extruded shape.



# Maintenance



**WARNING!** Any maintenance or repair work that requires opening of the motor or gear housing should be carried out only by an authorized Customer Service Center (see your dealer for information on locating a service center).



**WARNING!** To reduce the risk of electrocution or other personal injury, always unplug the tool from the power supply outlet before performing any maintenance or repair work on the tool.



**NOTICE:** Do not use compressed air to clean the motor housing of the tool, as you could inject foreign objects into the motor through the ventilation openings.



**NOTICE:** Certain cleaning agents and solvents are harmful to plastic parts. Some of these include, but are not limited to: Gasoline, Acetone, Methyl Ethyl Ketone (MEK), Carbonyl Chloride, cleaning solutions containing Chlorine, Ammonia, and household cleaners containing Ammonia.

## Routine Maintenance

### Keep the Saw Clean

Dust and debris from some materials can be extremely abrasive and cause components within the saw to wear prematurely. It is important to keep moving parts cleared of abrasive dusts.

- ▶ As a general rule, keep the saw clean of all dust and debris. Even soft-wood dust can be abrasive over time.
- ▶ Examine all moving parts for dust and debris.
- ▶ Keep the bevel hinges clean of dust using compressed air or cotton swabs. If the hinges wear due to abrasive particles, the saw will not perform optimally.
- ▶ Keep the blade area and dust extraction port clean of debris. Debris can cause wear and reduce the effectiveness of the dust extraction system.
- ▶ Periodically remove the blade cover (5 screws), the blade, and the inboard arbor flange; and clean any built up debris from the inside of the saw.



### Keep the Sawblades Sharp

Using a dull sawblade can be extremely dangerous and provide poor cut quality.

- ▶ Never attempt to sharpen a sawblade manually. Special equipment is necessary to properly sharpen a circular sawblade. An improperly sharpened sawblade can injure the operator, destroy the saw, and damage the workpiece.
- ▶ The sawblades should be sharpened regularly, and only by a qualified sharpening service.
- ▶ Improper grinding of the carbide teeth of a sawblade can result in serious injury to the saw operator.

### Adjust and Inspect the Saw

To ensure the saw is in proper working order, periodically inspect the operation of the saw and ensure it is properly adjusted.

- ▶ Observe the function of the saw during normal operation.
- ▶ Unusual sounds are indicative of pending problems.
- ▶ A reduction in the cut quality indicates the saw is either improperly adjusted or not functioning properly.
- ▶ A reduction in cutting power or speed may indicate a dull blade or a motor problem.
- ▶ If any of the safety devices on the saw are inoperable or disabled, immediately stop using the saw and have it serviced.
- ▶ Periodically inspect the wear bars for the guide rail cams for wear.

## Replacing the Guide Rail Splinter Guard

The splinter guard prevents splintering and chipping of the workpiece by holding the top edge of the workpiece down as the teeth of the sawblade move upward against it. The splinter guard needs to be replaced if it becomes damaged or worn.

1. Peel the original splinter guard away from the guide rail.
2. As needed, clean residual adhesive and debris from the guide rail.
3. Peel off the plastic backing from the new splinter guard to expose the adhesive.
4. Without stretching the rubber, carefully place the new splinter guard on the underside of the guide rail tight to the alignment rib.
5. Make sure the splinter guard is firmly pressed down to

the guide rail.

6. Trim the splinter guard as described on [page 8](#).

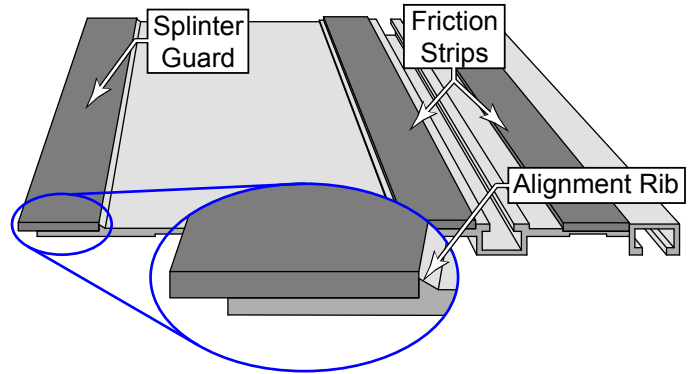

## Changing the Motor Brushes

Festool does not condone brush replacement by the end user. Completion of this procedure by an unauthorized service center will void the tool's warranty.

The motor brushes are graphite bars that provide an electrical connection between the motor controller and the rotating armature. When the brushes have worn past their useful length, spring loaded wear pins are exposed that separate the brush from the armature contacts. This disables the motor to prevent damage. For a shorter break-in period without excessive arcing, new brushes have ribs that quickly form to the curve of the armature.



**CAUTION!** Make sure the power cord is unplugged before beginning this procedure.

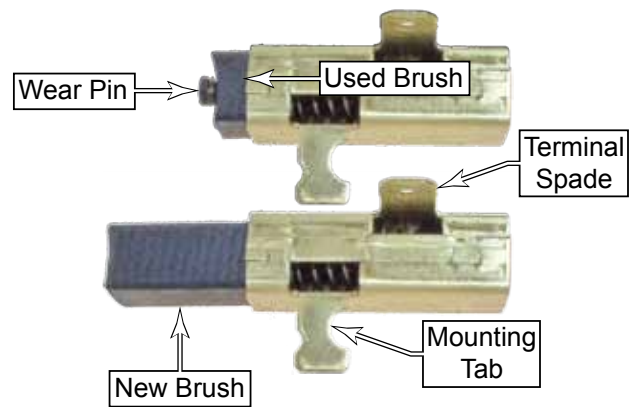

### Procedure

1. Unplug the saw.
2. Remove the four screws that secure the access cover to the motor, and remove the cover.



3. Lift the 2 wire connectors off the terminals on the brushes.



**NOTICE:** Take care to not pull on the red wires for the thermal sensor, or you may pull the sensor out of its pocket. The sensor is embedded in a thermally conductive paste.

4. Remove the screw that secures each brush to the motor housing. Be careful not to drop the screws into the motor.
5. Carefully lift the brushes up to remove them.
6. Insert the new brushes into the motor, and reassemble the saw by reversing the previous steps.

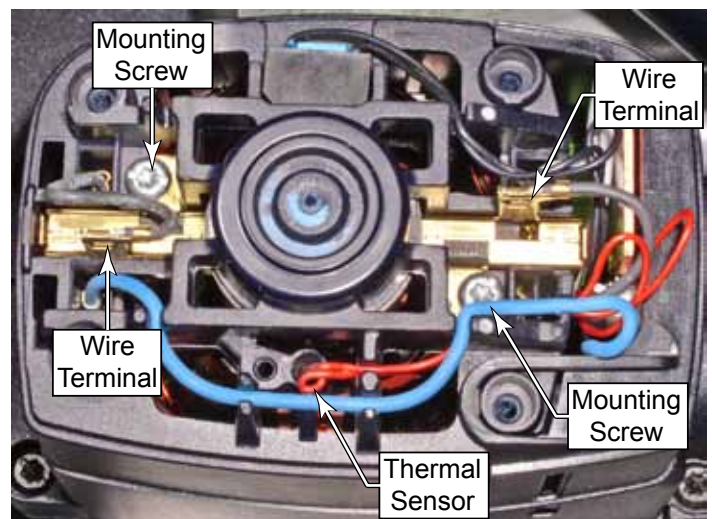

# Adjustments

## Matching Multiple Saws to Shared Guide Rails

If you own multiple saws that share common guide rails, you will want all of your saws calibrated to the same blade position. This will prevent one saw from cutting more guide rail splinter guard than another saw.

**i Note:** Depending on the cutting position of your existing saw(s), it may be necessary to match your existing saws to the cutting position of the TS 55 REQ. To prevent excessive misadjustment of the saw, the TS 55 REQ limits the blade position adjustment to be within 0.030" of the factory calibration. Older generation saws were not limited, and could potentially be misadjusted beyond specification. If your existing saws are adjusted beyond specification, they should be adjusted to match the TS 55 REQ.

1. Place a workpiece on a stable surface, and overhanging the edge so the saw blade can be set to maximum depth.
  - ▶ For best results, the workpiece should be a near-homogenous material, such as a tight grained wood or Medium Density Fiberboard (MDF).
  - ▶ The workpiece can be any length, as long as it is at least slightly longer than the saw.
  - ▶ The thickness of the workpiece is not critical, but you may have best results if it is between 3/4" and 1 1/4"
2. Securely clamp a guide rail to the workpiece, so that the guide rail will remain stationary as you switch between 2 or more saws.
  - ▶ Clamping the guide rail is important. If the guide rail moves during this procedure, you will have to start over.
3. Set the blade depth for all saws to their maximum depth.
4. Using the primary saw that you want your other saw(s) to match, cut the workpiece using a full-depth plunge.

**i Note:** Before adjusting a saw, you should first verify whether it needs adjustment. Check the saw's position using the procedure below, except do not loosen the adjustment screws.

5. Unplug all saws for safety.
6. Slightly loosen the 4 bevel block mounting screws from the underside of the saw. (These are located on the top side of TS 55 EQ and TS 75 EQ saws.)

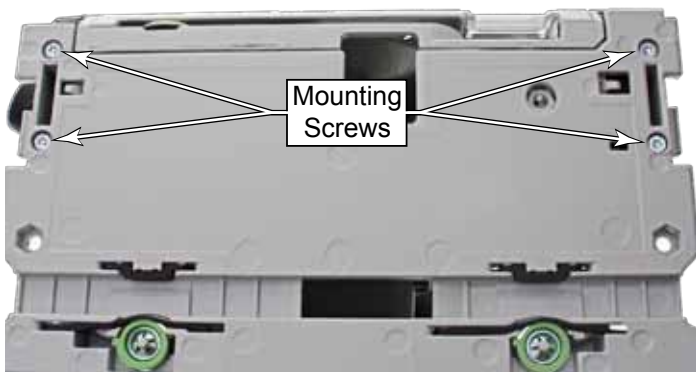

7. **Note:** The TS 55 REQ FastFix has a second stop position which is near full depth. To activate it, plunge the blade to full depth, then open the FastFix lever, and release the plunge until it clicks in place.
8. Without moving the guide rail, place the saw to be adjusted on the guide rail, and press against a forward tooth until it is touching the workpiece edge.
9. Insert a 0.15mm (0.006") feeler gauge between a rear tooth and the workpiece, and press the tooth against the gauge/workpiece. If a feeler gauge is not available, a piece of paper folded in half will equal 0.004" to 0.006".



10. For the TS 55 EQ or TS 75 EQ saws, carefully tighten all 4 bevel block mounting screws; taking care to not move the blade position in the process.
11. For the TS 55 REQ:
  - a. Carefully tighten the 2 forward bevel block mounting screws. These are double-ended screws that are also accessible from above the saw using a 2mm hex key. Note that they turn counterclockwise to tighten from above.
  - b. To tighten the rear bevel block mounting screws, carefully slide the saw to the rear of the guide rail until the screws are accessible from below.

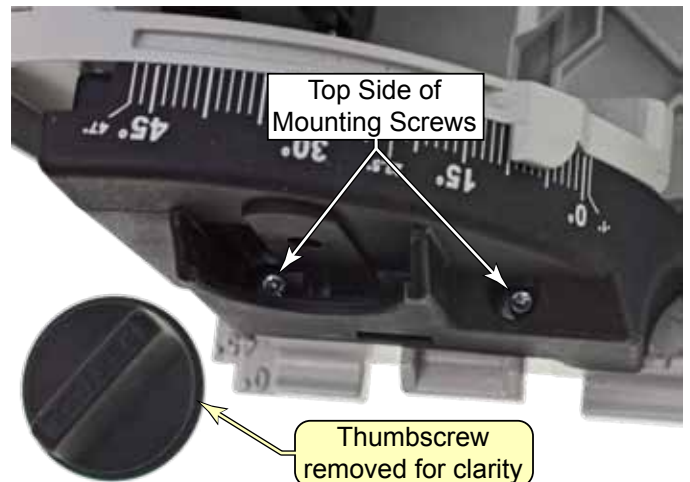

## Installing the Imperial Depth Gauge

The TS 55 REQ comes with an optional imperial depth gauge sticker to replace the standard metric depth gauge.

1. Set the depth gauge pointer to its maximum setting.
2. Using a sharp pencil, carefully mark the zero-depth position of the depth gauge on the blade housing.

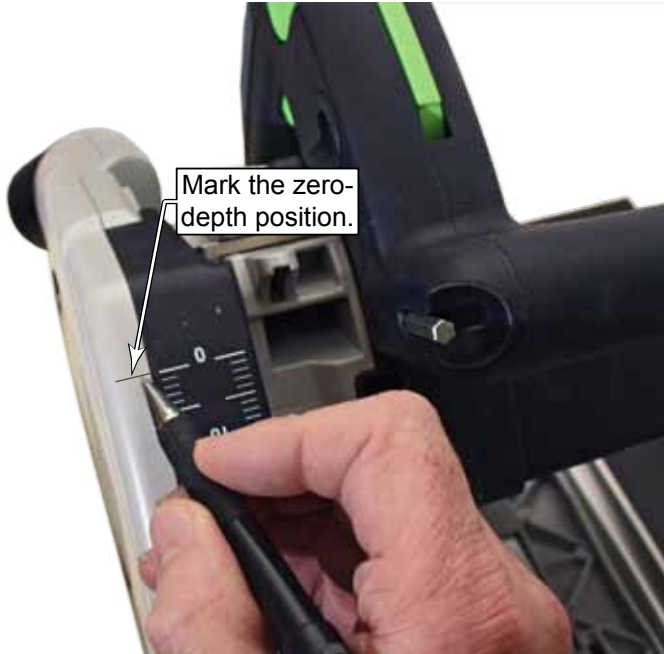

3. Peel back no more than 1/3 of the paper backing from the top of the sticker. Peeling the paper back at a slight angle (as shown) will reduce the likelihood of kinking the sticker later.

**i Important:** Notice that the top of the sticker has the zero-depth indicator, and the numbers increase as they go down.

4. Carefully position the sticker over the existing gauge with the zero-depth aligned with the pencil mark you made above, and straight along the edge of the blade cover.

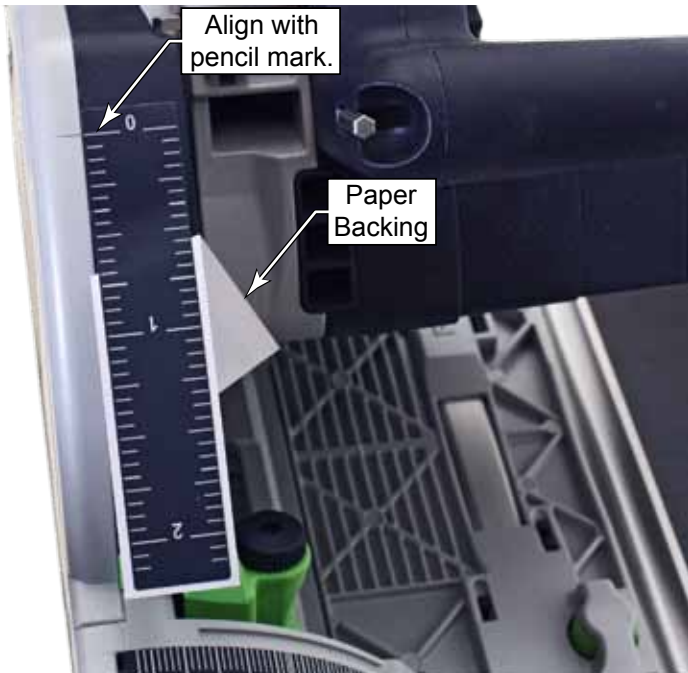

5. Taking care not to kink the sticker, tuck the bottom under the depth gauge pointer.
6. Make sure the sticker is properly aligned along the edge of the blade cover, peel back more of the paper backing, and press the sticker down.
7. Raise the depth pointer back toward zero, peel back the rest of the paper backing, and finish adhering the rest of the sticker.



# Troubleshooting

Symptom	Possible Causes
Motor does not start	<ul style="list-style-type: none"> <li>▶ Check that the cord is properly plugged into an outlet.</li> <li>▶ Make sure the Plug-it connector is properly inserted and fully tightened.</li> <li>▶ Make sure the outlet has power. Check the circuit breaker or try another outlet.</li> <li>▶ If used with a Festool dust extractor, make sure the selector switch is pointing to "Auto". The auxiliary outlet on the dust extractor has power only when the selector is at Auto.</li> <li>▶ Inspect the power cord (including extension cords) for damage or missing prongs.</li> <li>▶ The motor brushes may have worn and need replacement.</li> </ul>
The saw makes a "Growling" sound when it is first turned on or idling.	<ul style="list-style-type: none"> <li>▶ This is normal operation. Refer to <a href="#">page 15</a> for more information.</li> </ul>
The saw makes wavy cuts	<ul style="list-style-type: none"> <li>▶ Make sure the guide rail gib cams are properly adjusted.</li> <li>▶ Inspect the blade for damage.</li> <li>▶ Make sure the sole plate is not rocking on the guide rail.</li> <li>▶ Keep the blade depth consistent during the cut; don't raise and lower the blade.</li> <li>▶ Forcing an ATB-type blade into the cut too fast can cause the blade to deflect.</li> </ul>
Saw cuts are burning	<ul style="list-style-type: none"> <li>▶ Make sure to use the correct blade for the material.</li> <li>▶ Make sure the blade is sharp.</li> <li>▶ Make sure the blade is installed correctly (not turning backward).</li> <li>▶ Reduce the motor speed.</li> <li>▶ If possible, increase the blade depth.</li> <li>▶ Increase your feed speed.</li> </ul>
Excessive chipping on the lower edge of the cut	<ul style="list-style-type: none"> <li>▶ Make sure to use the correct blade for the type of material and type of cut.</li> <li>▶ A very shallow blade depth can cause chipping on the underside if the teeth are barely protruding below the surface. Increase the blade depth.</li> <li>▶ The blade toe-in may be incorrect. Refer to <a href="#">page 22</a> for more information.</li> </ul>
Excessive chipping on the top edge of the cut	<ul style="list-style-type: none"> <li>▶ Make sure to use the correct blade for the type of material and type of cut.</li> <li>▶ Inspect the splinter guard. Make sure it is flush with the cut line for its entire length.</li> <li>▶ Materials prone to splintering may splinter more if the blade is set too deep.</li> </ul>
The sawblade fails to retract after a cutting operation	<ul style="list-style-type: none"> <li>▶ The saw requires immediate service, and should be removed from operation. Contact Festool or your authorized Festool service provider.</li> </ul>





# FESTOOL®

Tools for the toughest demands

**Festool USA**

400 N. Enterprise Blvd

Lebanon, IN 46052

[www.festoolusa.com](http://www.festoolusa.com)

Service Questions:

800-554-8741

Application Questions:

888-337-8600

## Free Manuals Download Website

<http://myh66.com>

<http://usermanuals.us>

<http://www.somanuals.com>

<http://www.4manuals.cc>

<http://www.manual-lib.com>

<http://www.404manual.com>

<http://www.luxmanual.com>

<http://aubethermostatmanual.com>

Golf course search by state

<http://golfingnear.com>

Email search by domain

<http://emailbydomain.com>

Auto manuals search

<http://auto.somanuals.com>

TV manuals search

<http://tv.somanuals.com>