

# FESTOOL

## **Carvex PS420 Series Pendulum Jigsaws**



### **PS420EBQ, PSB420EBQ, PSC420EB, PSBC420EB Jigsaw Supplemental User's Manual**



**WARNING** To reduce the risk of serious injury, read and understand all safety precautions and instructions in this manual before using this tool.

---

# Limited Warranty<sup>1</sup>

## 30 Day Money Back Guarantee

Buy with confidence. If you are not completely satisfied, return your tool<sup>2</sup> to the selling dealer within 30 days and you will receive a refund of either your purchase price or the lowest retail price at which the same item has been offered since your date of purchase. Freight charges are not refundable.

---

## 1+2 Limited Warranty

Festool offers a 3 year limited warranty, one of the strongest in the industry. This warranty is valid on the pre-condition that the tool is used and operated in compliance with the Festool operating instructions. Festool warrants that the specified tool will be free from defects in materials and workmanship for a term of 3 years from the date of purchase.

---

## Conditions of 1+2 Limited Warranty

All customers receive a free extended limited warranty (1 year + 2 years = 3 Years) on new Festool power tools purchased from an authorized retailer. Festool is responsible for all shipping costs during the first year of the warranty. During the second and third year of the warranty the customer is responsible for shipping the tool to Festool. Festool will pay for return shipping to the customer using UPS Ground Service. All warranty service is valid 3 years from the date of purchase on your receipt or invoice. Proof of purchase may be required.

Excluded from the coverage under this warranty are: normal wear and tear, damages caused by misuse, abuse, or neglect; damage caused by anything other than defects in material and workmanship. This warranty does not apply to accessory items such as circular saw blades, drill bits, router bits, jigsaw blades, sanding belts, and grinding wheels. Operating a tool at a voltage or frequency different from the tool's rating will void the warranty. This includes the usage of the tool in combination with a transformer. Festool does not condone nor support the use of any non-Festool engineered, designed, and manufactured accessories or consumables with Festool products. Use of any non-Festool products may affect performance or void the warranty. Festool is not responsible for any damages or losses incurred and user assumes all risk and responsibility with non-Festool derived products. Also excluded are "wearing parts," such as carbon brushes, lamellas of air tools, rubber collars and seals, sanding discs and pads, and Festool gear (hats and shirts).

<sup>1</sup> The following is an exemplar Festool limited warranty. The actual warranty that comes with your power tool is controlling.

<sup>2</sup> Tool must be returned in complete and whole condition as supplied to include Systainer, cutter, blade, power cord, etc.

---

## Liability Statement

This product has been built to the high standards of Festool. Please do not attempt to operate or repair this equipment without adequate training. Any use, operation, or repair in contravention of this document is at your own risk. By acceptance of this system you hereby assume all liability consequent to your

---

## Proprietary Notice

All drawings and information herein are the property of Festool, TTS Tooltechnic Systems AG & Co. KG. All unauthorized use and reproduction is prohibited.

Written and Illustrated by Rick Christopherson.

© 2013 TTS Tooltechnic Systems AG & Co. KG

All rights reserved. Printed in the United States of America and Germany.

The obligations of Festool in its sole discretion under this warranty shall be limited to repair or replacement or a refund of the purchase price for any Festool portable power tool that is found to have a defect in materials or workmanship during the warranty period. FESTOOL SHALL NOT BE LIABLE FOR ANY CONSEQUENTIAL, INCIDENTAL OR SPECIAL DAMAGES REGARDLESS OF THE THEORY OF LAW ON WHICH THE CLAIM IS BASED. ALL WARRANTIES IMPLIED BY STATE LAW, INCLUDING THE IMPLIED WARRANTIES OR MERCHANTABILITY AND FITNESS FOR A PARTICULAR PURPOSE ARE HEREBY LIMITED TO THE DURATION OF THREE YEARS.

Some states in the U.S. and some Canadian provinces do not allow the limitations on how long an implied warranty lasts, so the above limitation may not apply to you. This warranty gives you specific legal rights, and you may also have other rights that vary from state to state in the U.S. and from province to province in Canada.

With the exception of any warranties implied by state or province law as limited above, the foregoing express limited warranty is exclusive and in lieu of all other warranties, guarantees, agreements, and similar obligations of Festool. Festool makes no other warranty, express or implied, for Festool portable power tools. This warranty policy is only valid for tools that are purchased in the US and Canada. Warranty policies of other countries may vary when obtaining warranty service outside the US and Canada. Some countries do exclude warranty for products bought outside their territory. Festool reserves the right to reject the repair of any tool that is not part of the US/Canada product line. No agent, representative, distributor, dealer, or employee of Festool has the authority to increase or otherwise change the obligations or limitations of this warranty.

---

## Repairs

If your Festool power tools require repair, you must contact our Service Department at 800-554-8741 (613-363-0169 Canada) for authorization and address details. To expedite the repair, please fill out and enclose the Repair Order Form. Download the form at [www.festoolusa.com](http://www.festoolusa.com) ([www.festoolcanada.com](http://www.festoolcanada.com)). No collect shipments will be accepted. No Festool hats, shirts or other wearables may be returned. Also contact our Service Department at the telephone number listed above if you have any questions about warranty claim procedures.

---

## Returns

If you need to return your Festool tools for any reason, please return it to the dealer from which you originally bought the tool.

use or misuse of this equipment. Festool assumes no liability for incidental, special, or consequential damage of any kind. Equipment specifications, applications, and options are subject to change at the sole discretion of Festool without notice.

Festool USA is a division of Tooltechnic Systems, LLC.

Festool is a trademark and service mark of TTS Tooltechnic Systems AG & Co. KG

Plug-It and Systainer are registered trademarks of TTS Tooltechnic Systems AG & Co. KG

[www.festoolusa.com](http://www.festoolusa.com)

---

# Contents

---

<b>About This Manual.....</b>	<b>3</b>	Setting the Pendulum Stroke .....	10
Tool Symbols .....	3	Installing/Removing the Battery .....	11
<b>General Power Tool Safety Warnings .....</b>	<b>4</b>	Charging the Battery .....	11
Work Area Safety .....	4	Connecting the Plug-It Power Cord .....	12
Electrical Safety .....	4	Installing the Splinter Guard .....	12
Personal Safety .....	4	Setting the Variable Speed .....	13
Power Tool Use and Care .....	4	Turning on the Saw .....	13
Service .....	5	Sawblade Selection .....	14
Specific Safety Rules for Reciprocating Saws .....	5	<b>Operation .....</b>	<b>15</b>
Specific Safety Rules for Battery Powered Tools .....	5	Using Dust Extraction .....	15
Respiratory Exposure Safety Warnings .....	5	Using the Jigsaw with a Guide Rail .....	15
<b>Functional Description.....</b>	<b>6</b>	Using the Trammel to Cut Circles.....	16
Intended Use.....	7	Making Bevel Cuts.....	17
Technical Specifications.....	7	<b>Maintenance and Adjustment .....</b>	<b>18</b>
<b>Setup.....</b>	<b>8</b>	Routine Maintenance .....	18
Changing the Sawblade .....	8	Adjustments.....	18
Adjusting the Blade Guide .....	8	Programming the LED light Function.....	18
Changing Base Inserts.....	9	<b>Troubleshooting .....</b>	<b>19</b>
Installing/Removing the Dust Collection Port.....	9		
Changing the Main Base.....	10		

---

## About This Manual

---

### Save These Instructions

It is important for you to read and understand this manual. The information it contains relates to protecting YOUR SAFETY and PREVENTING PROBLEMS. The symbols below are used to help you recognize this information.



**WARNING!** Indicates a potentially hazardous situation which, if not avoided, could result in death or serious injury.



**CAUTION!** Indicates a potentially hazardous situation which, if not avoided, could result in minor or moderate injury.



**NOTICE:** Indicates a potential situation which, if not avoided, can result in property damage or damage to the tool.



**Note:** Indicates information, notes, or tips for improving your success using the tool.

---

### Tool Symbols

V	Volts
W	Watts
Hz	Hertz
~	Alternating Current (AC)
n	No-load Speed
□	Class II Double Insulated

# General Power Tool Safety Warnings



**WARNING! Read all safety warnings and instructions.** Failure to follow the warnings and instructions may result in electric shock, fire, and/or serious injury.

**Save all warnings and instructions for future reference.**

## Work Area Safety

- ▶ Keep your work area clean and well lit. Cluttered or dark work areas invite accidents.
- ▶ Do not operate power tools in explosive atmospheres, such as in the presence of flammable liquids, gases, or dust. Power tools create sparks which may ignite the dust or fumes.
- ▶ Keep children and bystanders away while operating a power tool. Distractions can cause you to lose control.

## Electrical Safety

- ▶ Power tool plugs must match the outlet. Never modify the plug in any way. Do not use any adapter plugs with earthed (grounded) power tools. Unmodified plugs and matching outlets will reduce risk of electric shock.
- ▶ Avoid body contact with earthed or grounded surfaces such as pipes, radiators, ranges and refrigerators. There is an increased risk of electric shock if your body is earthed or grounded.
- ▶ Do not expose power tools to rain or wet conditions. Water entering a power tool will increase the risk of electric shock.
- ▶ Do not abuse the cord. Never use the cord for carrying, pulling, or unplugging the power tool. Keep cord away from heat, oil, sharp edges or moving parts. Damaged or entangled cords increase the risk of electric shock.
- ▶ When operating a power tool outdoors, use an extension cord suitable for outdoor use. Use of a cord for outdoor use reduces the risk of electric shock.
- ▶ If operating a power tool in a damp location is unavoidable, use a ground fault circuit interrupter (GFCI) protected supply. Use of a GFCI reduces the risk of electric shock.
- ▶ Never use an extension cord that is damaged, including cuts, exposed wires, or bent/missing prongs. Damaged extension cords increase the risk of fire or electric shock.
- ▶ Use only extension cords rated for the purpose.
- ▶ Use only extension cords rated for the amperage of this tool and the length of the cord. Using too small of an extension cord can cause the cord to overheat.

### Extension Cord Ratings

Cord Length	Size (AWG)
<50 Ft.	14
50-100 Ft.	12
>100 Ft.	Not recommended

## Personal Safety

- ▶ Stay alert, watch what you are doing, and use common sense when operating a power tool. Do not use a power tool while tired or under the influence of drugs, alcohol, or medication. A moment of inattention while operating power tools may result in serious personal injury.
- ▶ Use personal protective equipment. Always wear eye protection. Protective equipment such as dust mask, non-skid safety shoes, hard hat, or hearing protection used for appropriate conditions will reduce personal injuries.
- ▶ Prevent unintentional starting. Ensure the switch is in the off-position before connecting to power source, picking up, or carrying the tool. Carrying power tools with your finger on the switch or energizing power tools that have the switch on invites accidents.
- ▶ Remove adjusting key or wrench before turning the power tool on. A wrench or a key that is left attached to a rotating part of the tool may result in personal injury.
- ▶ Do not overreach. Keep proper footing and balance at all times. This enables better control of the tool in unexpected situations.
- ▶ Dress properly. Do not wear loose clothing or jewelry. Keep your hair, clothing, and gloves away from moving parts. Loose clothes, jewelry, or long hair can be caught in moving parts.
- ▶ If devices are provided for the connection of dust extraction and collection facilities, ensure these are connected and properly used. Use of dust collection can reduce dust-related hazards.
- ▶ Always wear safety glasses complying with ANSI Z87.1. Ordinary glasses are not proper protection.

## Power Tool Use and Care

- ▶ Do not force the power tool. Use the correct power tool for your application. The correct power tool will do the job better and safer at the rate for which it is designed.
- ▶ Do not use the power tool if the switch does not turn it on and off. Any power tool that cannot be controlled with the switch is dangerous and must be repaired.
- ▶ Disconnect the plug from the power source before making any adjustments, changing accessories, or storing the tool. Such preventive safety measures reduce the risk of starting the tool accidentally.
- ▶ Store idle tools out of reach of children and do not allow persons unfamiliar with the power tool or these instructions to operate the power tool. Power tools are dangerous in the hands of untrained users.
- ▶ Maintain power tools. Check for misalignment or binding of moving parts, breakage of parts and any other condition that may affect the power tool's operation. If damaged, have the power tool repaired before use. Many accidents are caused by poorly maintained power tools.
- ▶ Keep cutting tools sharp and clean. Properly maintained tools with sharp cutting edges are less likely to bind and are easier to control.
- ▶ Use the power tool, accessories, and tool bits etc. in accordance with these instructions, taking into account the working

conditions and the work to be performed. Use of the power tool for operations different from those intended could result in a hazardous situation.

- ▶ To reduce the risk of serious injury, never alter or misuse the power tool.

---

## Service

- ▶ Have your power tool serviced by a qualified repair person using only identical replacement parts. This will ensure that

the safety of the power tool is maintained.

---

## Specific Safety Rules for Reciprocating Saws

- ▶ Keep hands away from the blade and cutting area. Do not reach underneath the workpiece. The blade is fully exposed under the workpiece.
- ▶ Never hold the piece being cut in your hands or across your leg. It is important to support the work properly to minimize body exposure, blade binding, or loss of control.
- ▶ Check that there is enough space under the workpiece for the reciprocating saw blade. If the saw blade strikes another object, it may cause a kickback.
- ▶ Never cut material that is thicker than the length of the saw blade.
- ▶ Hold the saw by the insulated handles when performing an operation in which the sawblade may contact hidden wiring or its own cord. Contact with a "live" wire will make the exposed metal parts of the tool "live" and shock the operator.
- ▶ Never use a dust extraction system when making cuts that can result in sparks (unless a spark trap is installed), such as cutting through nails and other ferrous materials. Sparks and hot embers can cause a fire in the dust extraction system.
- ▶ Always check the saw blade to make sure it does not have missing teeth or is bent. Do not use a damaged saw blade.
- ▶ Do not touch the saw blade after prolonged cutting. The saw blade may be hot and cause burns.

---

## Specific Safety Rules for Battery Powered Tools

- ▶ Remove the battery before adjusting the tool or changing saw blades. Failure to do so may result in the tool starting unexpectedly.
- ▶ Use only battery packs specifically designated for use with the power tool. Use of any other battery packs may create a risk of injury and fire.
- ▶ Recharge the battery only with the charger specified by the manufacturer. A charger that is suitable for one type of battery pack may create a risk of fire when used with another battery pack.
- ▶ When the battery pack is not in use, keep it away from metal objects like paper clips, coins, keys, nails, screws, or other small metal objects that can make a connection from one terminal to another. Shorting the battery terminals together may cause burns or a fire.
- ▶ Under abusive conditions, liquid may be ejected from the battery; avoid contact. If contact accidentally occurs, flush with water. If liquid contacts eyes, additionally seek medical help. Liquid ejected from the battery may cause irritation or burns.
- ▶ Do not place batteries near fire or heat. This will reduce the risk of explosion and possibly injury.

---

## Respiratory Exposure Safety Warnings

Substantial or repeated inhalation of dust and other airborne contaminants, in particular those with a smaller particle size, may cause respiratory or other illnesses. Various dusts created by power sanding, sawing, grinding, drilling and other construction activities contain chemicals or substances known (to the State of California and others) to cause cancer, birth defects or other reproductive harm. Some examples of these chemicals/substances are: lead from lead-based paints; crystalline silica from bricks, cement, and other masonry products; arsenic and chromium from chemically-treated lumber; and some wood

dusts, especially from hardwoods, but also from some softwoods such as Western Red Cedar.

The risk from these exposures varies, depending on how often you do this type of work. To reduce your exposure to these chemicals: work in a well ventilated area and use a properly functioning dust extraction system. When the inhalation of dust cannot be substantially controlled, i.e., kept at or near the ambient (background) level, the operator and any bystanders should wear a respirator approved by NIOSH for the type of dust encountered.

# Functional Description



Item	Name or Description	Ref. Page(s)
A	Chip Guard	15
B	Base Insert	9
C	Pendulum Lever	10
D	Main Base	10
E	Left & Right Power Switch	13, 18
F	Blade Release Lever	8
G	Dust Collection Port	9, 15

Item	Name or Description	Ref. Page(s)
H	Plug-It Power Cord Port	12
I	Speed Control	13
J	Trigger Release	13
K	Variable Speed Trigger	13
L	Base Release Lever	10
M	Battery	11
N	LED Work Lights	18

## Intended Use

The Carvex jigsaw, is designed for sawing of wood, wood-like materials, and plastics. With special saw blades offered by Festool, the saw may also be used for cutting aluminum, steel, non-ferrous metals, and ceramic. The tool should not be altered or used for any other purpose, other than

as specified in these operating instructions. Using the tool in contravention to this manual will void your warranty and may lead to injury. The user shall be responsible and liable for damages and accidents resulting from misuse or abuse of this saw.

## Technical Specifications

### Jigsaws

		<b>PS 420 EBQ</b>	<b>PSB 420 EBQ</b>	<b>PSC 420 EB</b>	<b>PSBC 420 EB</b>
Description		Barrel Grip Corded	D-Handle Corded	Barrel Grip Battery	D-Handle Battery
Speed Range (strokes per minute)		1500-3800	1000-3800	1500-3800	1000-3800
Voltage		120 V, 50/60 Hz		10.8-18.0 VDC	
Power Consumption		400 W		N/A	
Stroke Length		26 mm (1.02")			
Pendulum Stroke		Off plus 3 orbit settings			
Maximum Depth of Cut (with appropriate blade)	Wood	120 mm (4.72")			
	Aluminum	20 mm (0.79")			
	Steel	10 mm (0.39")			
Bevel Angle		0° to 45° both sides, with optional angle base			
Weight		1.9 kg (4.2 lbs)		1.8 kg (4.0 lbs) w/o battery	

### Batteries and Charger

The battery powered jigsaws can be operated using any Festool BPC or BPS class battery pack, from 10.8 volts to 18.0 volts. The TRC 3 battery charger is capable of charging any Festool BPC or BPS class battery pack from 7.2 volts to 18.0 volts.

<b>TRC 3 Battery Charger</b>			
Input voltage		120 V, 60Hz	
Output Voltage		7.2 to 18.0 VDC	
Rapid Charge Rate		3 A max.	
Maintenance Charge Rate		0.06 A, pulsating	
LiIon Charging Rates	1.5 Ah	25 Min to 80%, 36 Min to 100%	
	3.0 Ah	55 Min to 80%, 70 Min to 100%	
Permitted charging Temperature		-5°C to +45°C (23°F to 113°F)	
<b>Available Batteries</b>		<b>BPC 15 Li</b>	<b>BPC 18 Li</b>
Voltage		14.4 V	18 V
Capacity		3.0 Ah	3.0 Ah
Weight		0.55 kg (1.21 lb)	0.67 kg (1.48 lb)

# Setup

## Changing the Sawblade

The Carvex jigsaw features tool-free blade changing. Used blades can be ejected from the saw without touching the potentially hot blade. New blades are inserted into the holder with just a simple twist.

Choosing the correct sawblade for the task is important for optimal results. Refer to "[Sawblade Selection](#)" on page 14.



**WARNING!** Always disconnect the saw from the power supply (power cord or battery) before making any adjustments to the saw or installing or removing the blade.



**CAUTION!** After prolonged use, the used sawblade may be hot. Take care not to touch the sawblade until it has cooled.

1. Unplug the saw or remove the battery. This procedure may require you to touch the blade with your fingers, so make sure the saw cannot start unexpectedly.
2. If the splinter guard is installed, remove it as described on [page 12](#).
3. Slide the blade release lever forward until the blade is ejected from the spring loaded holder.
4. Place the new blade into the diagonal slot on the blade holder, press it fully in, and rotate the blade until it locks into place. If the blade does not rotate easily, it is not pressed in far enough. The small tabs on the side of the blade must be inside the blade holder.
5. Adjust the blade guide as described below.

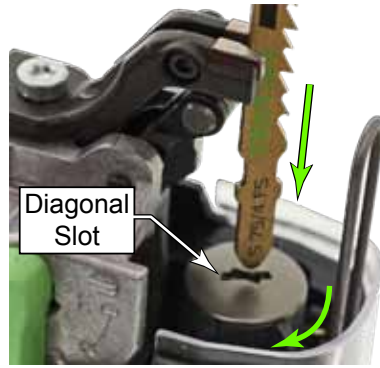

## Adjusting the Blade Guide

The Carvex jigsaw features a lower blade guide to ensure that the blade stays straight and true in the cut. If the blade was guided only by the blade holder, like many other jigsaws, the upper half of the blade could flex, which would make it more likely that the blade wouldn't be perpendicular to the workpiece. For longer life, the blade guide is carbide tipped to reduce wear.



**WARNING!** Always disconnect the saw from the power supply (power cord or battery) before making any adjustments to the saw or installing or removing the blade.

1. Unplug the saw or remove the battery. This procedure may require you to touch the blade with your fingers, so make sure the saw cannot start unexpectedly.
2. Install a blade in the saw.
3. Remove the Main Base as described on [page 10](#).
4. Using the provided 2.5 mm hex key, loosen the adjustment screw enough to ensure the blade fits loosely between the jaws of the blade guide.
5. Carefully push back on the blade to ensure it is fitting between the parallel faces of the blade guide jaws.
6. While wiggling the blade back and forth, tighten the adjustment screw until the jaws are almost touching the blade.

- ▶ Take care not to over-tighten the adjustment screw. If the jaws are too tight to the blade, you will have excessive wear on the jaws, and it may even prevent proper pendulum action.
- ▶ If the jaws are too loose, the blade won't be well guided in the cut.
- ▶ For optimal adjustment, you should be able to wiggle the blade side-to-side just a little bit.

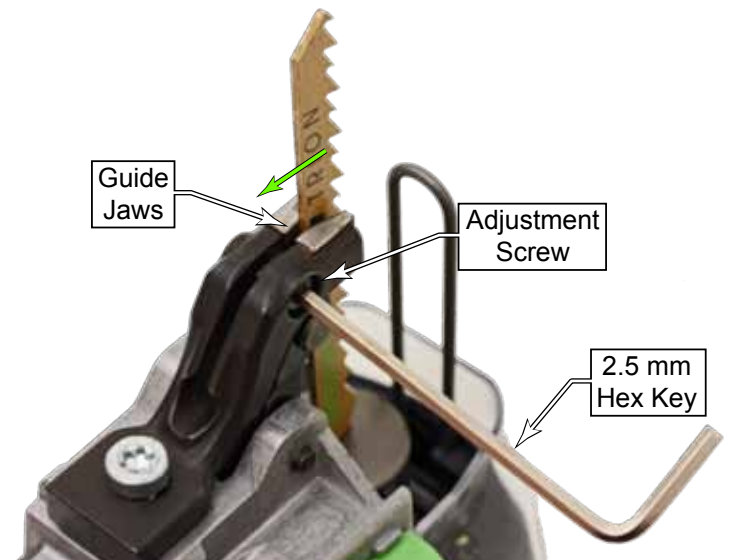



## Changing Base Inserts

The standard Carvex base can be fitted with one of 5 optional base inserts (shown below). Each base insert is described below.

- ▶ **Standard Insert:** This is a general purpose insert that is supplied with the saw, and may be used in all applications.
- ▶ **Felt Insert:** The felt insert provides a soft felt surface to the base of the jigsaw for mar-free cutting on finished materials. The bottom of the felt insert has a tight hook-&-loop surface that holds the replaceable/disposable felt pads in place.

- ▶ **Phenolic Insert:** This insert provides a smooth, hard, and low-friction base for abrasive environments that could scratch softer inserts.
- ▶ **Dimpled Insert:** This insert is designed to provide smooth operation on rough surfaces, such as rough-sawn lumber. The dimples (rounded studs) glide over and between the rough features of the workpiece surface.
- ▶ **Stainless Steel Insert:** This insert is ideal for working on steel, aluminum, and other very hard materials that would scratch even the phenolic insert.



**Standard Insert**



**Felt Insert w/  
Replaceable Felt**



**Phenolic Insert**

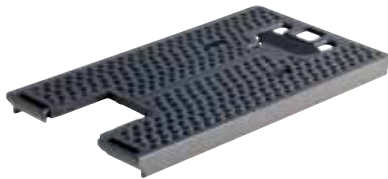

**Dimpled Insert**



**Stainless Steel Insert**

**i** **NOTE:** The optional Base Accessory Kit may include a small key and lanyard. This is for a European configuration to lock the power button, and is not used in North America.



1. Remove the dust collection port as described below. The release tab on the base insert cannot be pressed in when the dust collection port is in place.
2. Either remove the main base from the saw as described on [page 10](#), or remove the sawblade described on [page 8](#).
3. Press down on the back of the release tab and slide the base insert forward about 1/2 inch.
4. Lift the base insert off the main base to remove it.

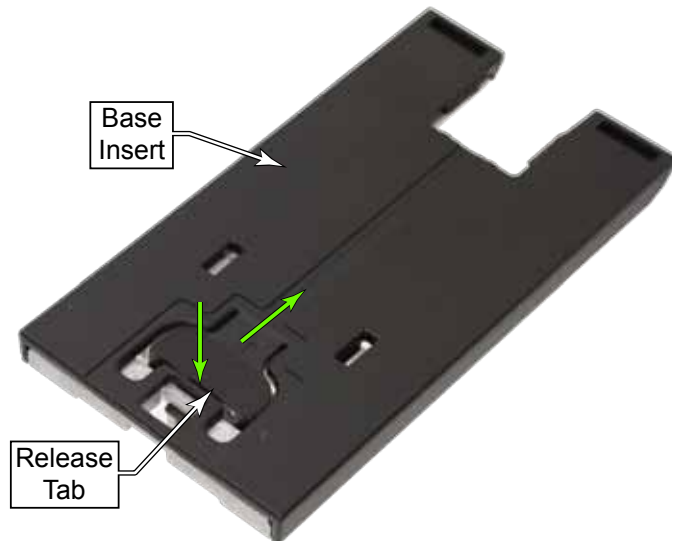

## Installing/Removing the Dust Collection Port

The dust port is used to connect a dust extractor to the jigsaw. Refer to ["Using Dust Extraction"](#) on page 15.

It may be used with the standard base or the guide rail base. However, the dust port cannot be used with the angled base. See [page 10](#) for more information on the different bases.

- ▶ To remove the dust port from the base, press down on the release tab and slide the port out from the base.
- ▶ To install the dust port, slide it into the base until the release tab clicks into place.

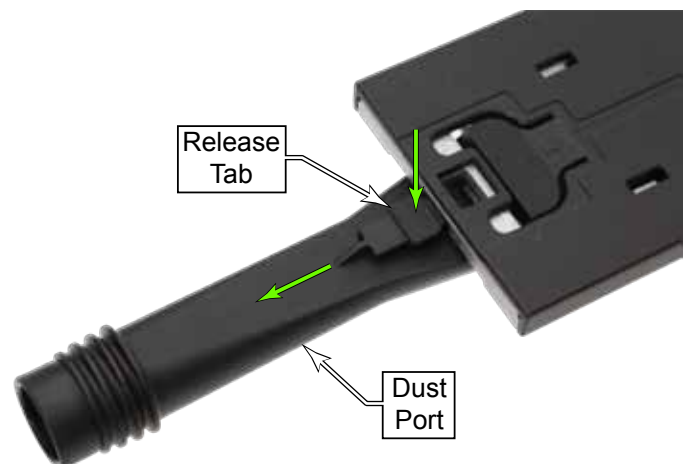

## Changing the Main Base

Three bases are available for the Carvex jigsaw. The bases can be installed and removed without tools.

- ▶ **Standard Base:** The Carvex saw comes equipped with the standard base and standard base insert. The standard base is used to mount any of the optional base inserts described on [page 9](#). The standard base can be used with or without dust collection.
- ▶ **Guide Rail Base:** The guide rail base, also called the adapter base, is used to guide the saw using either a

Festool guide rail, or the Festool trammel (for cutting circles). The guide rail base can be used with or without dust collection. For more information, refer to ["Using the Jigsaw with a Guide Rail"](#) on page 15 or ["Using the Trammel to Cut Circles"](#) on page 16.

- ▶ **Angle Base:** The angle base is used for making bevel cuts with the jigsaw. The two pads can be angled from +45° to -45°. For more information, refer to ["Making Bevel Cuts"](#) on page 17.



Standard Base



Guide Rail Base



Angle Base



**NOTE:** Make sure the guide rail base is installed parallel with the blade by wiggling it side to side before closing the release lever. If it is installed with a slight skew to the saw blade, it may cause the saw to drift off the cutting line when using the saw with a guide rail or trammel.



**WARNING!** Always disconnect the saw from the power supply (power cord or battery) before making any adjustments to the saw or installing or removing the blade.

1. Unplug the saw or remove the battery to prevent accidental startup.
2. Rotate the base release lever outward until the clamp is clear of the main base.
3. Lift the main base off the bottom of the saw.

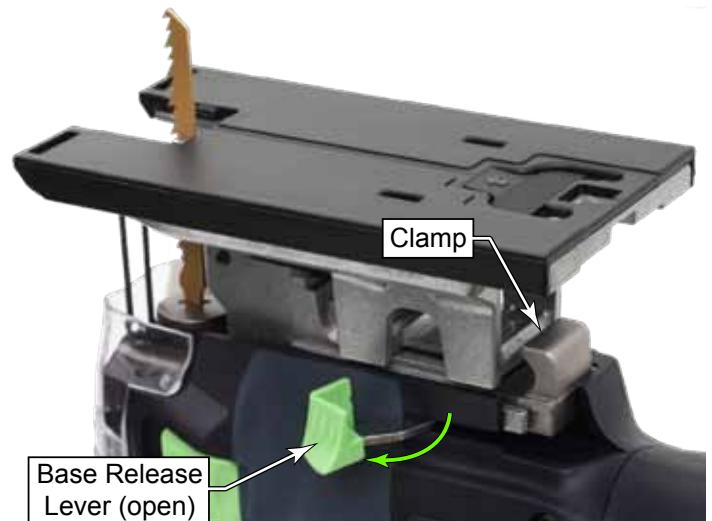

## Setting the Pendulum Stroke

A conventional jigsaw moves the blade up and down in a straight line. A pendulum jigsaw moves the blade in an orbital motion. On the downstroke, the blade is guided away from the cut, and on the upstroke, the blade is guided toward the cut.

The Carvex jigsaw has 4 settings for the pendulum stroke, ranging from a wide orbit to no orbit (straight up and down). Because a jigsaw cuts only on the upstroke, this orbital type of motion is more efficient.

The orbital motion allows the saw to cut more aggressively and improves the life of the blade. However, the larger the orbit and more aggressive the cut, the rougher the cut may be.

To change the pendulum stroke, rotate the lever to settings 0 (off) through 3 (maximum orbit). The lever/setting may be changed regardless whether the saw is running or not.

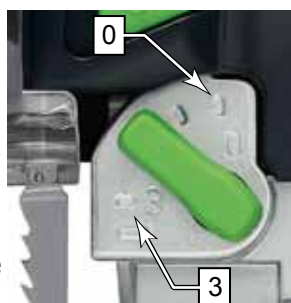

Use a larger orbit (higher number) for aggressive cutting in softer materials. Use a smaller orbit, or no orbit, for harder materials such as harder woods, metals, ceramics, etc.; or when smoother cuts are desired. Also, when cutting thinner materials, a lower orbit setting may produce better results. The pendulum stroke should be set to zero when using a tungsten carbide blade.

Down/Clearing Stroke

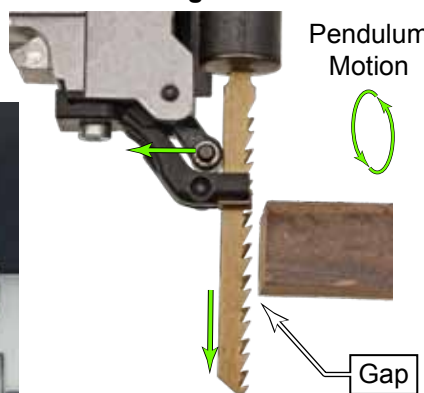

Up/Cutting Stroke

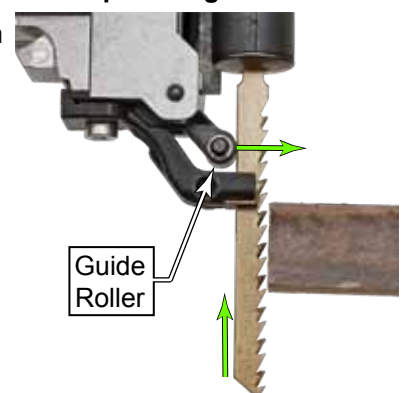

## Installing/Removing the Battery

The battery powered Carvex jigsaws (PSC 420 EB and PSBC 420 EB) use a removable BPC-series 18V LiIon battery pack for their power. However, if needed, the saw may also be powered using any BPC or BPS series battery from 12 to 18 volts. However, performance may be reduced when using a smaller battery.



**WARNING!** Do not use any battery clips to hang a jigsaw from your tool belt or waistband. The saw can start unexpectedly, causing serious personal injury. If a battery has the battery clip installed, it is recommended to remove the clip to prevent it from catching on objects during operation.

To install the battery, slide it into the receptacle on the rear of the saw until it clicks into place. To remove the battery, press in on both left and right release buttons, and slide the battery out of the receptacle.



## Charging the Battery

Battery equipped Carvex saws include a TRC 3 intelligent battery charger. This charger may be used to charge any Festool BPC (LiIon) or BPS (NiCd, NiMH) series battery. The charger is microprocessor controlled and will detect the type of battery being charged as well as the condition of the battery.

To charge a battery, slide it onto the battery slot until it is fully seated. The status light will change when the charger detects the presence of the battery (fully seated). The meanings of the status light indications are listed below:

- ▶ **Yellow, Steady:** Charger is ready, no battery present.
- ▶ **Green, Rapid Flash:** The battery is being charged at its maximum charging rate.
- ▶ **Green, Slow Flash:** The battery is approaching full charge and is being charged at a reduced charging rate.
- ▶ **Green, Steady:** The battery is fully charged.
- ▶ **Red, Flashing:** General fault indication, such as faulty battery pack or faulty connection to battery.
- ▶ **Red, Steady:** The battery temperature is too high to safely charge. Charging will commence when the temperature returns to a lower level.



After the battery has been fully charged, the intelligent charger will switch to a maintenance mode to maintain a full charge on the battery. The battery may be left in the charger until needed. However, it is not recommended to leave a battery in the charger for long-term storage.

For infrequently used batteries, overall battery life will be improved if they are stored with a partial charge, and recharged only before needed.

## Connecting the Plug-It Power Cord

The corded Carvex jigsaws (PS 420 EBQ and PSB 420 EBQ) come equipped with a removable Plug-It power cord. The cord can be removed for easier storage of the tool. The Plug-It port on the PS 420 EBQ model can also be rotated when used inverted under a workpiece, or for fitting in tighter corners.

To install the power cord, insert the cord into the inlet (port) on the tool with the key and keyway aligned, and twist the locking ring  $\frac{1}{4}$ -turn until it clicks. Reverse the procedure to remove the cord.

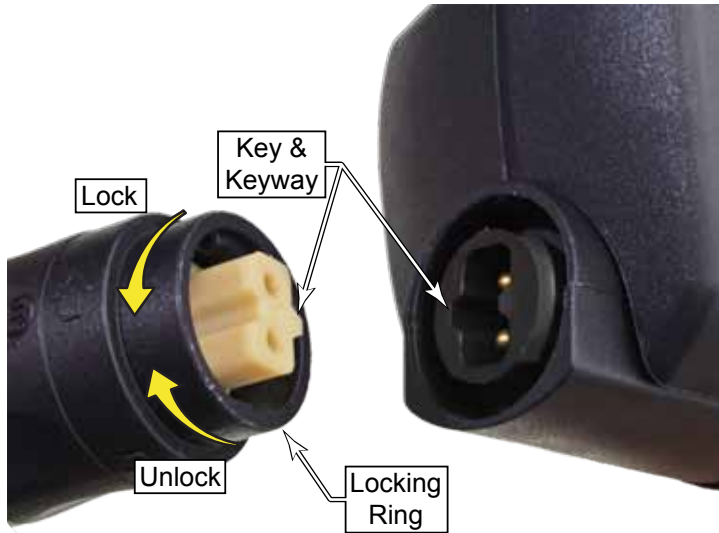

**NOTICE:** Make sure to fully tighten the plug-it cord a full quarter-turn until it clicks. If the plug is not fully locked, the socket and cord can overheat and be damaged.



**NOTE:** The 18 gauge plug-it cord is interchangeable with other tools that use the same size cord, but it cannot be used with larger tools, such as routers and saws. The plug has an extra key to prevent it from being used on a larger tool that would otherwise damage the cord. Larger cords may be used with smaller tools, but not the reverse.



## Installing the Splinter Guard

The clear plastic splinter guard serves as a zero-clearance throat along the blade to reduce splintering of the topside of the workpiece. The splinter guard is a consumable component that is replaced when it wears or when blades of different thicknesses are used.



**WARNING!** This procedure requires the saw to be powered and in operation during a portion of the installation procedure. Care must be taken to prevent personal injury. Remove the battery or unplug the saw when instructed to do so.

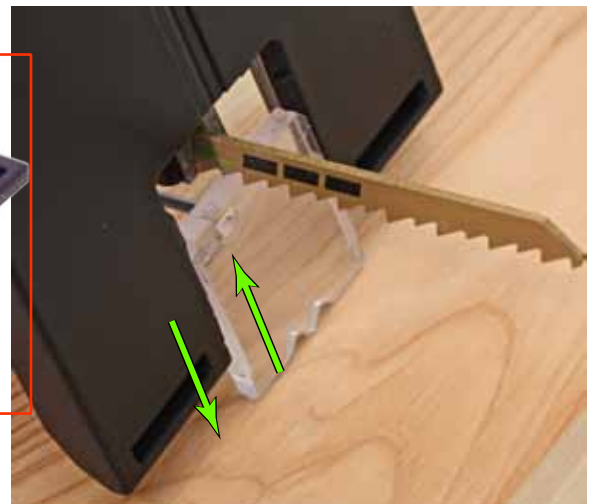
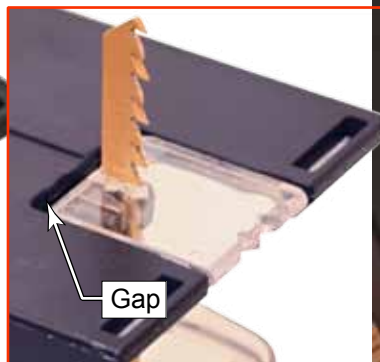
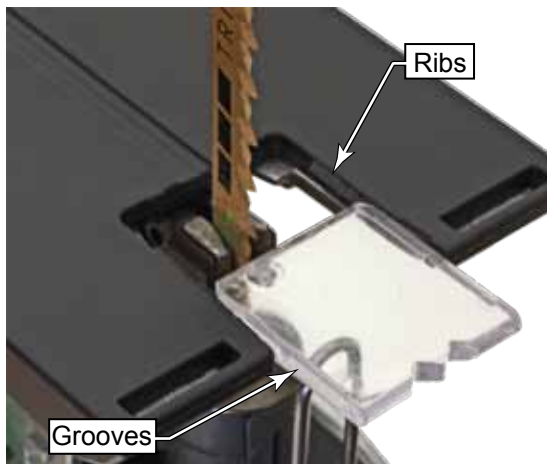

1. Unplug the saw or remove the battery to prevent accidental starting.
2. Rotate the pendulum stroke lever to the zero position.
3. Slide the plastic splinter guard onto the ribs on the main base, but not far enough to touch the blade.
4. Turn the saw on, and press the front of the splinter guard against a table to allow the sawblade to cut into the splinter guard as it slides the rest of the way on the base.
5. For added life, as the splinter guard wears, you can push it farther back into the base until the gap is gone.

## Setting the Variable Speed

The speed of the saw can be varied from 1500 to 3800 strokes per minute. The two D-handle models have a broader speed range of 1000 to 3800 strokes per minute when the variable speed trigger is utilized.

The Carvex jigsaws also include an automatic speed setting, designated with an "A" on the speed dial. In this setting, the saw will operate at maximum speed during a cut, but will operate at a reduced speed before the blade makes contact with the workpiece. This reduced speed makes it easier to line up the sawblade with your cut line at the beginning of your cut.

To set the speed of the saw, rotate the speed dial to the desired setting from 1 to A. The speed may be adjusted while the saw is running.

For the D-handle models, the speed control dial acts as a maximum speed limit when the variable trigger is used. The more you press in on the variable trigger, the faster the saw will operate, until it reaches the speed setting of the speed dial.

The optimal speed of the saw is somewhat subjective, but is predominately determined by the type of material being cut. The actual speed that delivers the best results for a specific cut may depend on other factors, such as blade type, workpiece brittleness, desired smoothness of cut, etc. The table to the right provides a general guideline for blade speeds, but your actual speeds may vary ("A" indicates maximum speed).

Material	Speed
Soft wood products and veneer plywoods	4-A
Hard wood products	3-A
Plastic laminate countertops	4-A
Hard plastics	3-A
Soft plastics	1-4
Plaster and cementitious hardboard	2-A
Aluminum, Ceramic	3-5
Steel	1-4



## Turning on the Saw

All saw models have power switches on the left and right side of the main housing. The D-handle saws also have a variable speed trigger in the handle.

To use the power switches on the barrel, slide either switch forward to start the saw, and then release the switch. The saw will continue to run until you slide either of the switches forward again.

- ▶ The speed of the saw will be determined by the speed control dial described above.
- ▶ It is not necessary to hold the switch forward while the saw is running.
- ▶ Either switch may be used to turn the saw on or off.

To use the variable speed trigger on a D-handle model, press in on the trigger release and pull up on the trigger.

- ▶ The speed of the saw will be controlled by how much the trigger is pulled, but the speed control dial determines the maximum available speed.
- ▶ It is not necessary to continue to hold the trigger release button, but it is necessary to continue to hold the trigger depressed for the saw to run.
- ▶ The automatic speed control function is not available when the trigger is used.

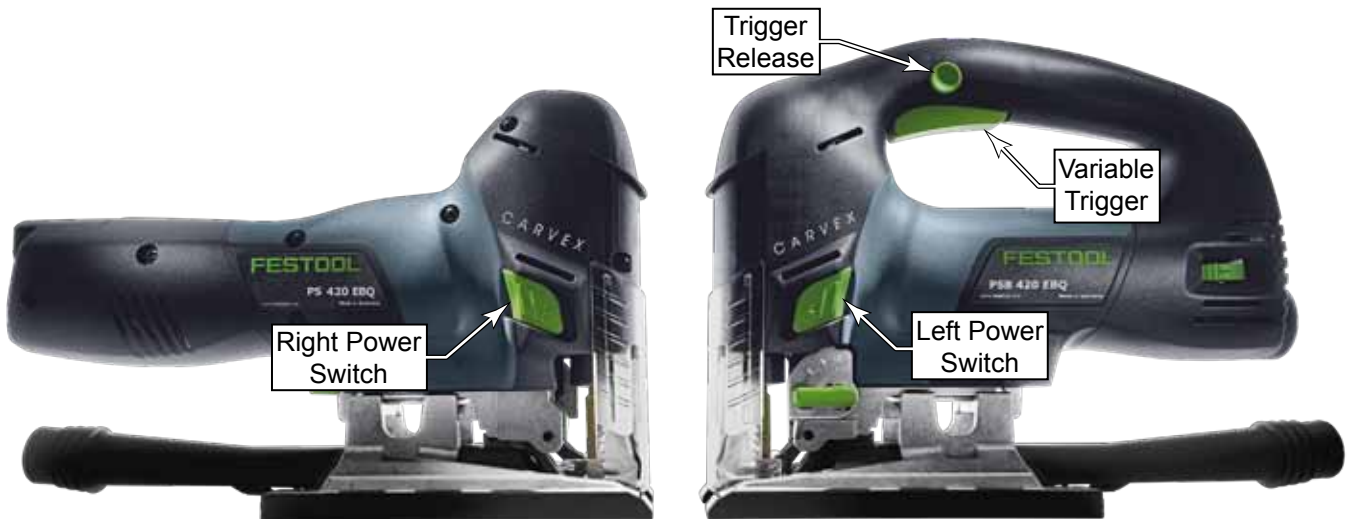

## Sawblade Selection

Festool sawblades are designed for optimal performance in a variety of applications. Choosing the correct sawblade is important for obtaining the best cuts and optimal blade life. There are several factors that determine which blades are best suited for the operation.

Some of the important parameters for choosing the best blade are length, tooth shape, tooth spacing, tooth set, and type of metal used for the blade body and teeth.

### Blade Usage

The shank of Festool sawblades are color coded according to their general usage intention. These colors are listed below. The specialty blades are an exception in that each blade will have its own special purpose and material type. These include carbide tipped blades, ceramic cutting blades, and serrated foam blades.

 Wood  Plastic  Metal  Specialty

### Blade Length



**NOTICE:** Always use a saw blade that is long enough to fully cut through the workpiece. Never attempt to make a partial-depth cut with a jigsaw. Attempting to make a cut with a saw blade that is too short to fully cut the workpiece will likely damage the blade and possibly the saw itself.

It is important to use a saw blade that is the correct length for the material being cut. Because part of the sawblade never extends below the sole plate of the jigsaw, the blade length must be greater than the thickness of the workpiece to be cut.

The length of a jigsaw blade is specified by the length of the body that contains teeth, but does not include the upper shank that fits inside the blade holder. The example below shows a 75 mm blade. The usable length of this blade is approximately 54 mm (2 $\frac{1}{8}$ " ), which is 75 mm minus the 19 mm that does not extend below the saw's sole plate, minus the distance of the lowest tooth from the tip of the blade.

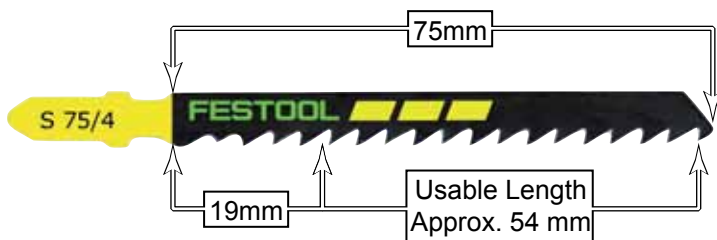

### Tooth Type

Saw blades will have different types of teeth depending on the purpose of the blade and the type of material it is expected to cut.

- ▶ Angle ground teeth are the most common type of teeth for wood cutting applications. These teeth have sharpened sides as well as sharp points to provide effective side cutting of the teeth, and not just the tips.
- ▶ Straight ground teeth are more typical for plastic and metal cutting blades, but some wood cutting blades may also have straight ground teeth. The tips of the teeth are the primary cutting edges for the blade.
- ▶ Carbide tipped blades provide for longer blade life. Carbide is a harder metal that does not dull as quickly as

other metals used for the blade bodies.

- ▶ Tungsten carbide abrasive blades are used for cutting very hard materials, such as ceramics. These types of blades cut in an abrasive or filing type of action.
- ▶ Serrated blades are used for cutting very soft materials, such as building foam. The blade functions much like a knife in its cutting action.

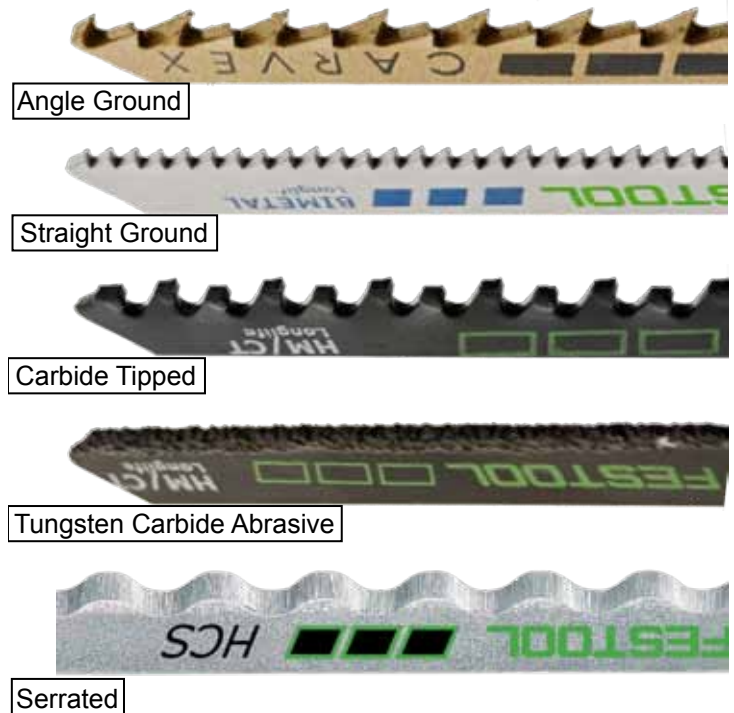

### Tooth Set

The term "tooth Set" refers to whether the teeth of the blade extend out past the body of the blade. This permits the kerf of the blade's cut to be wider than the body of the blade, which reduces the likelihood of the blade binding in the cut or overheating due to friction.

- ▶ Conical ground blades (also called tapered or trapezoidal blades) do not have any set in their teeth, but the body of the blade is ground to be narrower than the width of the teeth. These blades provide very smooth cuts because the teeth are not set side-to-side from the body of the blade, but the body of the blade still has some clearance within the saw kerf.
- ▶ Side Set teeth are when each individual tooth is alternately bent to the left or right of the blade body. This results in the kerf width to be wider than the blade body, and also makes these blades more aggressive in their cutting action. However, the wider the tooth set, the rougher the cut surface will be.
- ▶ Wavy set teeth are used almost exclusively for fine-tooth blades, such as metal cutting or fine scroll blades. The teeth are so close together that it is not possible to put a set on each tooth separately, so the teeth are set in groups with a waving pattern down the length of the body.



# Operation

## Using Dust Extraction

The Carvex jigsaw can be used with or without a dust extraction system. For best results, however, a dust extraction system (such as the Festool CT 22 shown below) should be used. Festool dust extractors have the added features of variable speed, and sensing when the corded model saw is turned on. When a corded model saw is plugged into the electrical outlet on the vacuum, the vacuum will automatically start when the saw is turned on, and will remain running for a couple of seconds after the saw turns off to clear the remaining dust.

**i NOTE:** A battery operated saw will not activate the automatic function of the vacuum. The vacuum will have to be activated manually.

**i NOTE:** The Angled Base (see [page 10](#)) does not permit the dust collection port to be installed. Therefore, dust collection will not be available.

1. To use the dust extraction system, install the dust collection port as described on [page 9](#).
2. For improved air flow of the vacuum, slide the chip guard down.



3. Slide the vacuum hose over the dust collection port. The outside diameter of the port is approximately 27 mm.

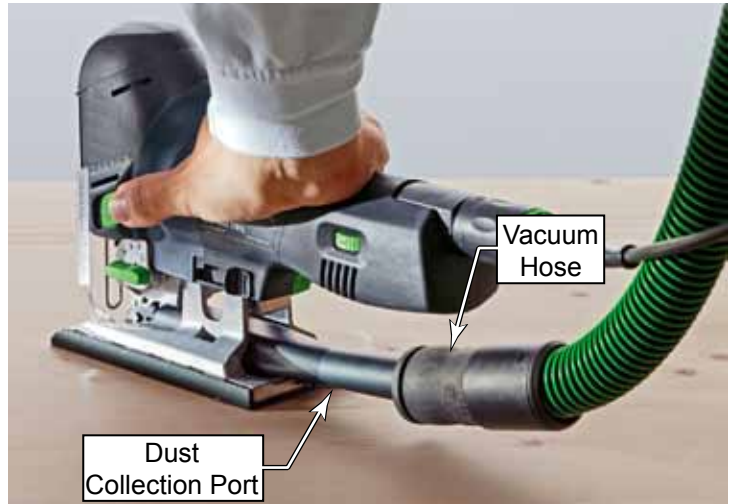

4. For corded models, plug the jigsaw into the electrical receptacle on the front of the dust extractor, and turn the power switch to "Auto".

▶ When the power switch is in the manual or off position, the electrical outlet will not have any power.

5. For cordless models, turn the power switch to manual.

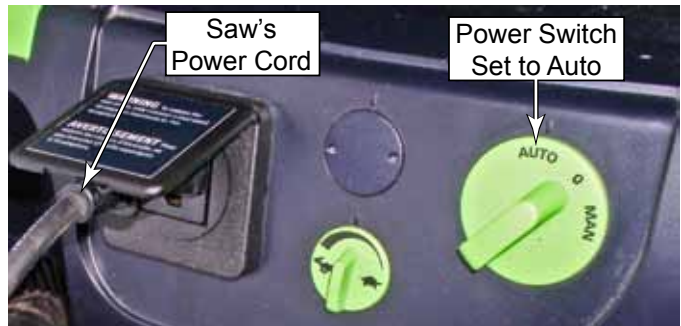

## Using the Jigsaw with a Guide Rail

When the optional guide rail base (see [page 10](#)) is installed on the jigsaw, the saw may be used with a Festool guide rail for performing straight cuts. In this configuration, the distance from the rear edge of the guide rail to the center of the blade is approximately 1 3/8" (35mm).

1. Install the optional guide rail base as described on [page 10](#).
2. Position the guide rail parallel to the desired cut line, and 1 3/8" (35mm) away from the center of the cut. Note, you will need to subtract 1/2 the thickness of the blade to set the distance to the edge of the cut instead of the center of the cut.
3. Clamp the guide rail to the workpiece.

**i NOTE:** The body of the jigsaw does not press down on the guide rail. To reduce the chance of slipping, it is recommended to clamp the guide rail.

4. For best results, it is recommended to use a blade with a wide tooth side set, such as the FSG blades.

5. Place the jigsaw base over the rear T-slot of the guide rail and perform the cut as normal.

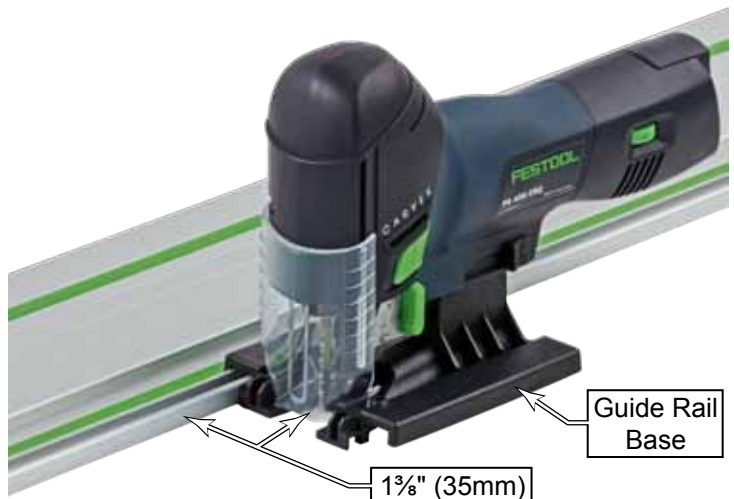

## Using the Trammel to Cut Circles

The optional circle cutter (trammel) permits the jigsaw to cut circular holes in a workpiece from the minimum and maximum sizes shown in the table below.

	Min Inch	Max Inch	Min mm	Max mm
<b>Radius</b>	1 <sup>13</sup> / <sub>16</sub>	59	46	1500
<b>Diameter</b>	3 <sup>3</sup> / <sub>8</sub>	118	92	3000

The optional circle cutting trammel attachment mounts to the underside of the optional guide rail base (see [page 10](#)). The circle cutting attachment contains the following features:

- ▶ Built-in tape guide showing the cutting radius from 46 mm to 1500 mm.
- ▶ Clamping knob to lock the trammel at the desired radius.
- ▶ Index pointers and trammel points for either right- or left-hand mounting to the jigsaw base.
- ▶ Trammel points for either clockwise or counterclockwise cutting directions.
- ▶ Trammel point pin with on-tool storage location.

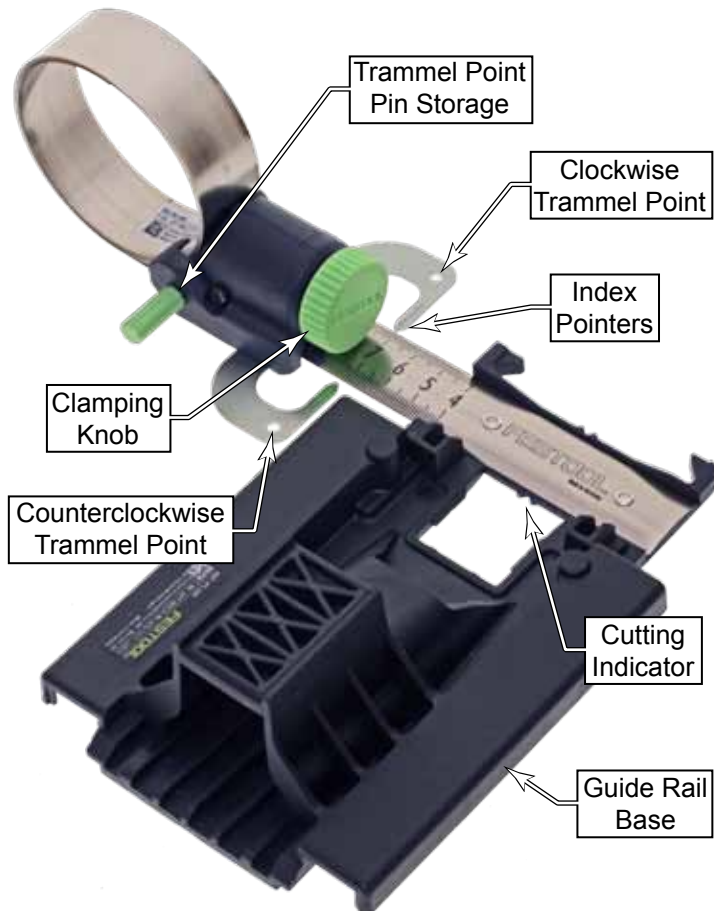

1. Identify the location of the center of the arc or circle you wish to cut.
2. Drill a 4mm (5/32") hole at the center of the arc or circle.
3. Loosen the clamping knob and extend the tape measure until the index pointers are pointing to the desired radius. The radius is 1/2 the diameter of a circle.
4. Retighten the clamping knob.
5. Insert the trammel point pin through the trammel point of the circle cutter, and into the hole you drilled into the workpiece above.
  - ▶ There are 2 trammel points on the circle cutter. One is for clockwise rotation and the other for counterclockwise rotation. Use the trammel point that is directly across from the sawblade when the circle cutter is mounted to the jigsaw.
6. Install the desired sawblade into the saw. If the radius/diameter of the cut is small, use a scrolling sawblade. For larger diameter circles, the high side set teeth of the FSG blades will probably work best.
7. Install the guide rail base on the saw as described on [page 10](#).
8. If you are cutting a full circle, you will need a starting point for the sawblade that lines up with your circle.
  - a. Using a pencil and the cutting indicator, trace out a portion of the circle where you will manually begin cutting.
  - b. Drill a hole on the waste-side of your circle large enough to insert the sawblade into.
  - c. Use this starting hole to manually begin cutting the circle—just enough to get the sawblade lined up with the cut.
9. Place the jigsaw onto the circle cutter and continue with the cut.
10. Before completing the cut, make sure that both the waste piece and the saved piece are supported.

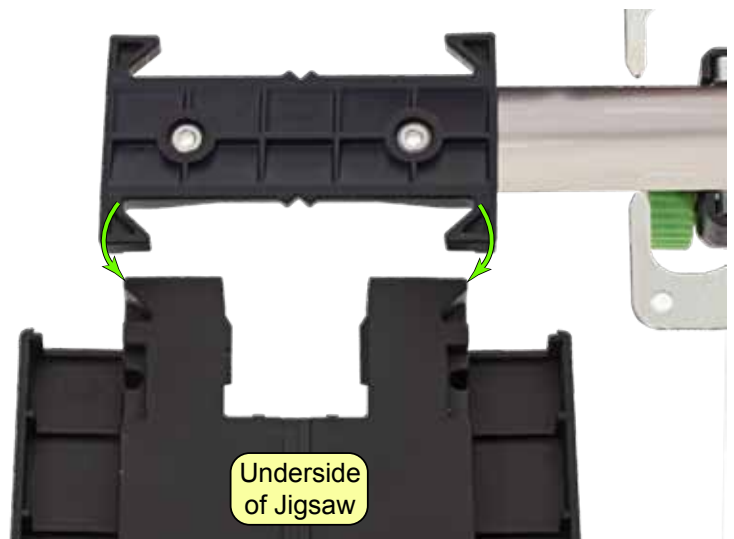



## Making Bevel Cuts

Bevel cuts may be made with the optional angle base. The angle base provides bevel angles up to  $48^\circ$  to the left and to the right. It can also function on both inside and outside corners for edge registration.



To adjust the bevel angle, rotate the adjustment knob on the rear of the angle base. Rotating the knob clockwise raises the bevel feet. Rotating the knob counterclockwise lowers the bevel feet.

The best way of setting the bevel angle is to set the angle between the left and right bevel feet. The angle between the bevel feet will be twice the bevel angle.

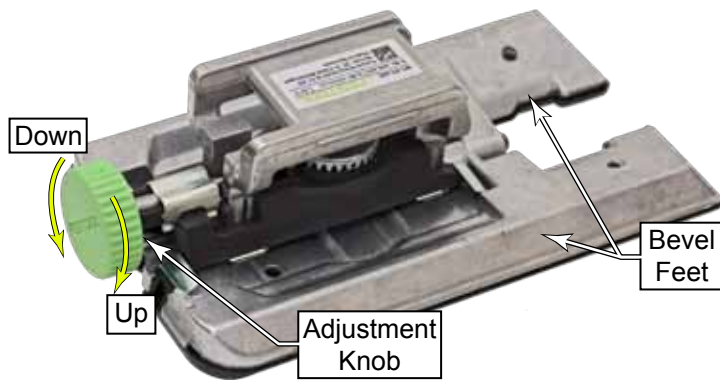

**i Hint:** A digital angle finder is ideal for this operation. In the example below, the angle finder was reset to zero when the two arms were pointing in opposite directions ( $180^\circ$ ). The reading on the display ( $45^\circ$ ) is twice the actual bevel angle ( $22.5^\circ$ ).

For setting the approximate angle, the angle base includes a built-in angle indicator that shows the angle between the base and the blade.

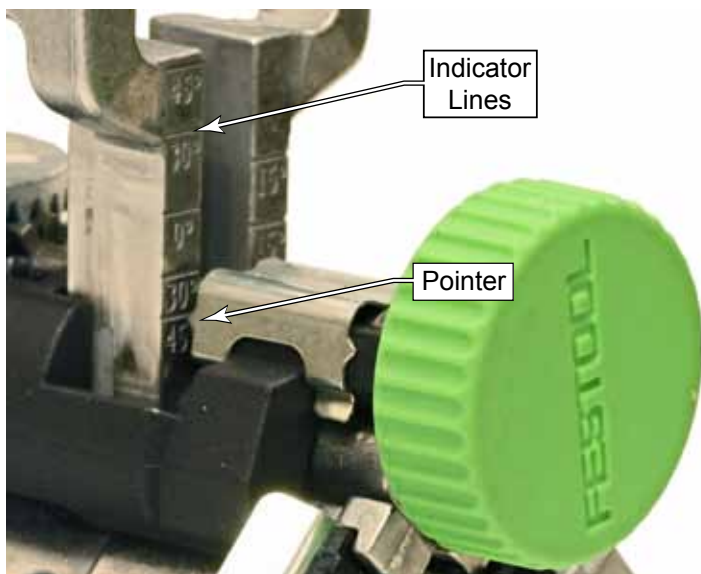

# Maintenance and Adjustment



**WARNING!** Any maintenance or repair work that requires opening of the motor or gear housing should be carried out only by an authorized Customer Service Center (see your dealer for information on locating a service center).



**WARNING!** To reduce the risk of electrocution or other personal injury, always unplug the tool from the power supply outlet or remove the battery before performing any maintenance or repair work on the tool.



**NOTICE:** Do not use compressed air to clean the motor housing of the tool, as you could inject foreign objects into the motor through the ventilation openings.



**NOTICE:** Certain cleaning agents and solvents are harmful to plastic parts. Some of these include, but are not limited to: Gasoline, Acetone, Methyl Ethyl Ketone (MEK), Carbonyl Chloride, cleaning solutions containing Chlorine, Ammonia, and household cleaners containing Ammonia.

## Routine Maintenance

### Keep the Saw Clean

Dust and debris from some materials can be extremely abrasive and cause components within the saw to wear prematurely. It is important to keep moving parts cleared of abrasive dusts.

- ▶ As a general rule, keep the saw clean of all dust and debris. Even soft-wood dust can be abrasive over time.
- ▶ Examine all moving parts for dust and debris.
- ▶ Keep the blade area and dust extraction port clean of debris. Debris can cause wear and reduce the effectiveness of the dust extraction system.

## Adjustments

### Programming the LED light Function



**WARNING!** The stroboscopic function of the LED light may make it difficult to determine the blade position, or give the appearance that the blade is not moving.



**WARNING!** Never look directly into the LED lights. The lights are very bright and may damage your vision.

The LED work lights have 3 programmable settings. These are stroboscopic, steady-on, and off. To reduce the likelihood of the bright LED lights from shining in the operator's eyes, the lights will automatically turn off any time the saw is rotated slightly past vertical toward the upside down position. These three operating modes are described below:

**Stroboscopic:** The stroboscopic function means that the LEDs will operate in unison with the speed of the sawblade stroke. This synchronous operation will make the sawblade appear stationary, instead of a blur of motion. The purpose of this stopped-motion appearance is to make it easier to follow a pencil line.

The stroboscopic effect is active only when the blade speed is above approximately 2100 strokes per minute. This means the frequency range of the light is 35 to 63 Hertz.

**Steady-On:** In the steady-on mode, the LED lights will be active and steady-on anytime the saw is operating, except when the saw is turned upside down.

**Off:** In this mode, the LED lights are disabled.



**WARNING!** Do not perform this adjustment with a sawblade installed in the jigsaw. This adjustment may result in the saw starting unexpectedly.

1. Remove the sawblade from the saw as described on [page 8](#).
2. Hold the saw in such a manner that when the LED lights turn on, they will not shine directly into your eyes.

3. Simultaneously press and hold both left and right barrel power switches until the saw beeps.
  - ▶ If the saw turns on, turn it back off and try again. The saw may turn on if both switches are not pressed simultaneously.
  - ▶ It will take approximately 10 seconds for the saw to beep from the time you first pressed the two switches.
  - ▶ The LED lights may or may not come on after the saw beeps, depending on the previous program mode.
4. When the saw beeps, release both power switches.
5. Press and release the right-hand power switch to cycle through the 3 programming options.
  - ▶ The LED lights will indicate the current program mode. They will flash if in stroboscopic mode. They will be steady-on for steady-on mode. They will be off for the off-mode.
6. When the desired program mode is selected, Press and release the left-hand power switch to exit program-mode.

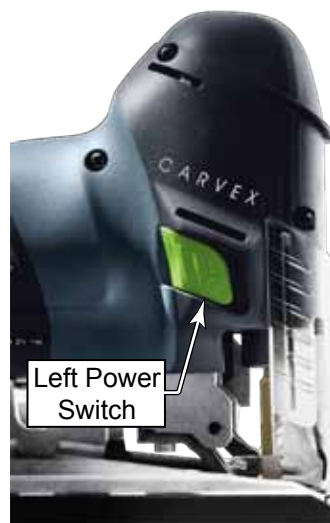

# Troubleshooting

Symptom	Possible Causes
Motor does not start (corded models)	<ul style="list-style-type: none"> <li>▶ Check that the cord is properly plugged into an outlet.</li> <li>▶ Make sure the Plug-it connector is properly inserted and fully tightened.</li> <li>▶ Make sure the outlet has power. Check the circuit breaker or try another outlet.</li> <li>▶ If used with a Festool dust extractor, make sure the selector switch is pointing to "Auto". The auxiliary outlet on the dust extractor has power only when the selector is at Auto.</li> <li>▶ Inspect the power cord (including extension cords) for damage or missing prongs.</li> </ul>
Motor does not start (cordless models)	<ul style="list-style-type: none"> <li>▶ Make sure the battery is properly charged and correctly installed on the saw. If possible, try a different battery to determine if the problem persists.</li> </ul>
LED work lights not functioning properly	<ul style="list-style-type: none"> <li>▶ Verify that the LED light function is correctly programmed as described on <a href="#">page 18</a>. The LEDs have 3 programmable options for "steady-on", "stroboscopic", and "off".</li> <li>▶ The LEDs will turn off if the saw is inverted or tilted slightly past the vertical position. This is to prevent the lights from shining into the operator's eyes. The LEDs will resume normal operation the next time the saw is turned on while in the normal horizontal position.</li> </ul>
The saw blade will not eject	<ul style="list-style-type: none"> <li>▶ Make sure you have removed the splinter guard before attempting to eject the blade. The blade cannot rotate with the splinter guard in place.</li> <li>▶ Make sure to use the correct sawblade identified for use with a Carvex jigsaw. Some blades may be too thick or have too much paint on the shank to easily slide out. If a thick blade rotates to the eject position but does not come out, try to gently pull it out with pliers.</li> <li>▶ Inspect the blade holder to make sure it is in the Park position (fully retracted). If the blade holder is not in the Park position, unplug the saw and press the tip of the blade against a work surface to retract it.</li> </ul>
Saw blade burns on the rear of the blade shank (away from the teeth)	<p>Additional symptoms may include: bluish discoloration of the metal, sparks emanating from the blade guide area, the blade bends backward even under a light cutting speed.</p> <ul style="list-style-type: none"> <li>▶ The blade guides are set too close for the thickness of the saw blade. Readjust the blade guides. <ul style="list-style-type: none"> <li>▶ The guides should barely contact the blade without restricting the movement of the blade.</li> <li>▶ Note that for thinner workpieces, the blade guides can be set fairly wide without adversely affecting the cut quality.</li> </ul> </li> </ul>
Poor cut quality	<ul style="list-style-type: none"> <li>▶ Make sure to use the correct blade for the desired cut: <ul style="list-style-type: none"> <li>▶ Saw blades with a wide set to the teeth will cut more aggressively (faster), but will leave more scratches in the side of the cut.</li> <li>▶ Saw blades with fewer teeth will cut more aggressively, but may be more prone to chipping in some woods.</li> <li>▶ Saw blades with a wider shank (front-to-rear) cut better in a straight line, but are more difficult for cutting tight curves.</li> </ul> </li> <li>▶ Don't force the saw through the cut. Let the blade work at the speed it was intended.</li> <li>▶ Use the correct blade speed. Too slow of a speed may result in rough cuts. Too fast can burn the workpiece.</li> </ul>
Dust extractor will not auto-start when the saw starts	<ul style="list-style-type: none"> <li>▶ If the speed of the saw is set to 1 and the saw is not yet cutting, it may not draw enough power from the dust extractor to activate the auto-start function. The extractor should start once the saw begins drawing more power during a cut.</li> <li>▶ The saw's power cord must be plugged into the extractor's auxiliary outlet. The auto-start feature will not function with battery powered jigsaws.</li> </ul>

# FESTOOL®

Tools for the toughest demands

**Festool USA**

400 N. Enterprise Blvd

Lebanon, IN 46052

[www.festoolusa.com](http://www.festoolusa.com)

Service Questions:

800-554-8741

Application Questions:

888-337-8600

## Free Manuals Download Website

<http://myh66.com>

<http://usermanuals.us>

<http://www.somanuals.com>

<http://www.4manuals.cc>

<http://www.manual-lib.com>

<http://www.404manual.com>

<http://www.luxmanual.com>

<http://aubethermostatmanual.com>

Golf course search by state

<http://golfingnear.com>

Email search by domain

<http://emailbydomain.com>

Auto manuals search

<http://auto.somanuals.com>

TV manuals search

<http://tv.somanuals.com>