



FilterStream[®]

Advanced Cleaning Appliances[™]

INSTRUCTION MANUAL

DirtTamer SUPREME V2400 CORDLESS WET|DRY VAC

Download from www.Somanuals.com. All Manuals Search And Download.

IMPORTANT SAFEGUARDS	4	HOW TO USE	14
		Picking Up Dry Debris	
		Picking Up Liquid & Wet Debris	
ABOUT YOUR DIRTTAMER SUPREME	6		
		CLEANING TIPS	15
VACUUM DESCRIPTION	7		
		MAINTENANCE/FILTER REPLACEMENT	16-18
WALL MOUNTABLE CHARGING BASE	8	Emptying/Cleaning Pre-Filter and Bowl	
		Cleaning/Replacing Foam and HEPA Filters	
BATTERY CHARGING PROCEDURE	9	Cleaning Vacuum Cleaner	
		BATTERY REPLACEMENT	19
CHARGE AND LOW BATTERY INDICATORS	10		
		ACCESSORIES	19
CLEANING TOOLS	11-12		
		WARRANTY	Back Cover
DIRT FINDING HEADLIGHT	12		
3-STAGE FILTRATION SYSTEM	13		

Congratulations!

You now own a top-quality FilterStream®
DirtTamer Supreme V2400 Cordless Wet/Dry Vacuum.
To ensure maximum satisfaction, please
take a few moments to review the following
important information before using this item.

Thank You!

IMPORTANT SAFEGUARDS

When using electrical appliances, always follow basic precautions, including the following:
PLEASE READ ALL INSTRUCTIONS CAREFULLY BEFORE USING THIS APPLIANCE

WARNING: To reduce the risk of fire, electrical shock or injury:

- Close supervision is necessary when any appliance is used by or near children. Do not allow this vacuum cleaner to be used as a toy.
- Do not use without bowl and filters in place. Clean bowl, pre-filter, filter cover, and foam filter (or HEPA filter) after picking up any perishable food items.
- To protect against risk of electrical shock, do not put unit or charging base in water or other liquid.
- Do not pick up anything that is burning or smoking, such as cigarettes, matches, or hot ashes.
- Avoid picking up hard, sharp objects with the vacuum as they may damage the vacuum and the filters.
- Do not use to pick up toxic substances, flammable or combustible liquids, such as gasoline, or operate in the presence of explosive or flammable fumes. Although this vacuum is designed to pick up liquids, only the nozzle end of the bowl should be placed in a liquid. Do not immerse the entire vacuum in any liquid.
- Do not operate in the presence of explosives and/or flammable fumes or liquids.
- Do not unplug the charger by pulling on the cord. Never carry the charger or base by the cord or yank to disconnect from an outlet; instead, grasp the charger and pull to disconnect. Do not pull cord around sharp edges or corners.
- Do not allow the cord to hang over the edge of a table or counter or touch hot surfaces. The vacuum should be placed or mounted away from sinks and hot surfaces.
- The use of an extension cord is not recommended. Only plug the charger into a standard electrical outlet (120V/60 Hz).

- Use only the charger supplied with this unit to recharge this vacuum.
- Do not attempt to use the charger with any other product.
- Never handle the plug or vacuum with wet hands.
- Do not operate with a damaged cord or charger. If this unit has been dropped into water, or if it malfunctions, return the unit to the store where it was purchased.
- Unplug the charger from outlet before any routine cleaning or maintenance.
- Do not put any object into openings. Do not use with any opening blocked; keep free of dust, lint, hair, or anything that may reduce airflow.
- Do not operate vacuum without filters in place. Replace any damaged filter promptly.
- Do not use on or near hot surfaces.
- Use extra care when cleaning on stairs.
- This vacuum is intended for household use only and not for commercial or industrial use.
- Use only as described in this manual. Use only FilterStream® DirtTamer® accessories and filters.

- This product contains a sealed lead acid battery. Do not incinerate the battery as it will explode at high temperatures. Always dispose of the battery in accordance with your state's laws.
- Leaks from a battery can occur under extreme conditions. If the battery liquid gets on skin, wash immediately with water. If it gets in your eyes, immediately flush your eyes with a mild solution of baking soda and water and seek medical attention.

SAVE THESE INSTRUCTIONS

ABOUT YOUR DIRTTAMER SUPREME

Your DirtTamer Supreme V2400 Cordless Wet/Dry Vacuum is the most advanced hand-held vacuum of its kind. Exhibiting superior suction, extra long runtime, patented 3-stage filtration, and the unique ability to trap 99.97% of allergy causing particles with the included HEPA filter, your DirtTamer Supreme will clean your home better than any other cordless hand-held vacuum.

Your DirtTamer Supreme V2400 comes complete with a headlight, exclusive charge and low battery level indicators, charging base, foam filter, HEPA filter and 3 handy cleaning tools, so you can clean anywhere, anytime.

Please follow this manual for the proper set-up, use, and care of this revolutionary cleaning product.

VACUUM DESCRIPTION

Your DirtTamer Supreme vacuum contains the following parts:

- 1 Charging Base
- 2 Bowl
- 3 Bowl Nozzle
- 4 Bowl Latch
- 5 Charge and Low Battery Indicators
- 6 On/Off Switch
- 7 Handle/Housing
- 8 Battery Compartment
- 9 Charger and Cord
- 10 Squeegee
- 11 Upholstery Brush
- 12 Extendible Wand/Crevice Tool
- 13 Plastic Wall Anchors
- 14 Screws
- 15 Filter Cover
- 16 Pre Filter
- 17 Foam Filter
- 18 HEPA Filter
- 19 Exhaust Port
- 20 Dirt Finding Headlight

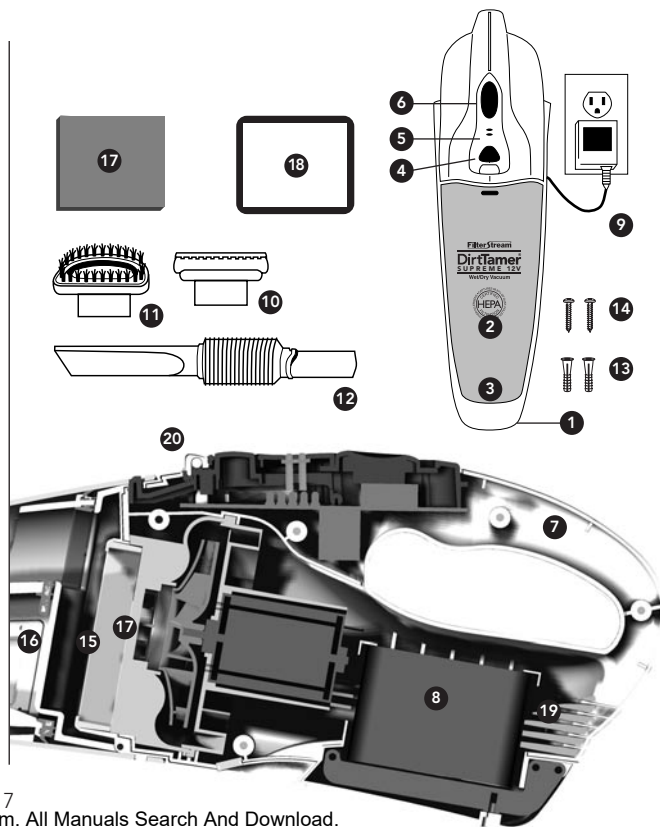

WALL MOUNTABLE CHARGING BASE

The Charging Base recharges your DirtTamer Supreme V2400 vacuum and stores the vacuum with its cleaning tools for convenient access.

The Charging Base can be mounted vertically (see Figure A) or placed on a horizontal surface such as a counter, shelf, etc.

If you choose to wall mount the Charging Base, please follow these steps:

1. Pick a convenient position within 6 feet of an electrical outlet. If the Charging Base will be mounted closer to an outlet, wrap any excess cord in the storage area on the back of the Charging Base. (Note: Do not use an outlet which is controlled with a wall switch).
2. Place the Charging Base against the wall in the desired location and mark the center of each hole.
3. Drill a $\frac{3}{16}$ " diameter hole through the center of the top mark. Push a Plastic Wall Anchor into the drilled hole.
4. Insert one of the included screws and turn it until the screw head is $\frac{1}{4}$ " above the wall surface.

5. Recheck that the hole alignment is straight, then drill the second hole and install the other Plastic Wall Anchor and Screw.
6. Slide the Charging Base into place making sure the cord exits through one of the slots.

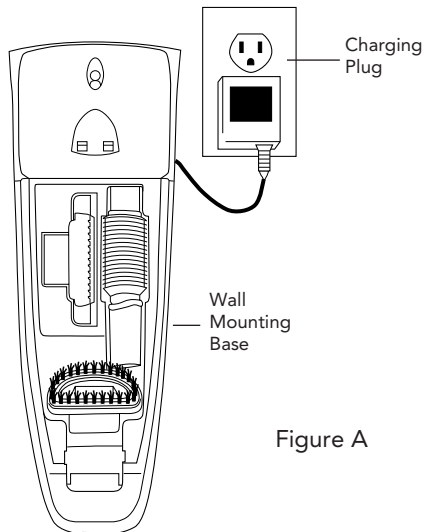

Figure A

BATTERY CHARGING PROCEDURE

1. Plug the Charging Base into a 110/120 volt electrical outlet.

2. **IMPORTANT:**

Make sure that the On/Off switch is turned to the "Off" position before charging. Otherwise, your vacuum will not charge.

3. Slide the vacuum downward onto the Charging Base making sure that the vacuum firmly hooks onto the Charging Base (see Figure B). Your vacuum will begin charging and the Green LED light on the Charge Indicator will glow to show charging is taking place. If your DirtTamer Supreme V2400 is completely out of power, a full recharge will take approximately 10 hours.

NOTE: before first use, charge your vacuum for at least 24 hours.

4. To maintain a charge, keep the Charger plugged into a standard wall outlet at all times. When charging, the Charger may be warm to the touch. This is normal.

Figure B

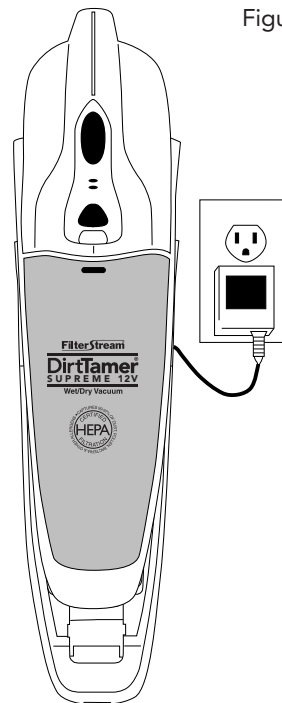

CHARGE AND LOW BATTERY INDICATORS

Unique LED lights monitor the power condition of your DirtTamer Supreme V2400 vacuum

Green Light Only:

Indicates that the vacuum is **charging** or **"on"** and **operating at an acceptable level** of power.

Red Light Only:

The red light will illuminate when your vacuum is almost out of power and needs to be recharged.

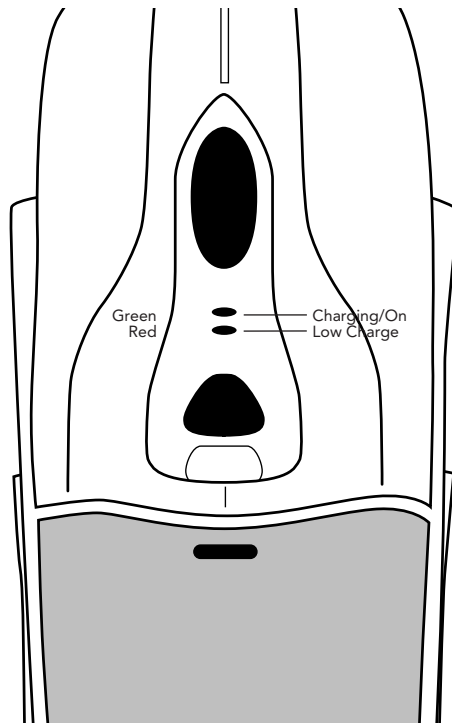

CLEANING TOOLS

Your DirtTamer Supreme V2400 vacuum includes the following unique cleaning tools that will make your cleaning tasks easier.

1. SQUEEGEE

This tool has rubber edges for picking up liquid spills on hard surfaces such as floors, countertops, etc. Attach the Squeegee to your vacuum by pushing the tool firmly into the Bowl Nozzle.

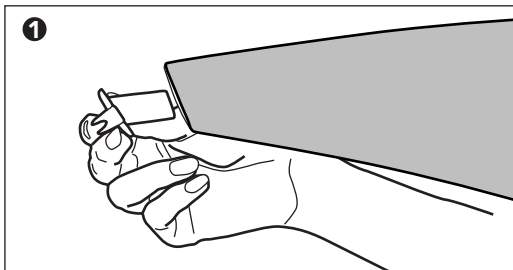

2. EXTENDIBLE WAND/CREVICE TOOL

This "two in one" tool works great as a long reach cleaning wand or a crevice tool.

To use as a long reach cleaning wand, simply extend the tool by pulling each end of the tool in opposite directions (the tool will expand like an accordion) and insert the larger end into the Bowl Nozzle. The wand is then ready for cleaning hard to reach areas (e.g. ceiling corners, under appliances, etc.).

To use as a crevice tool: simply compress the tool to your desired length and insert the larger end into the Bowl Nozzle. The crevice tool is then ready to use in tight places such as between car seats, in corners, etc.

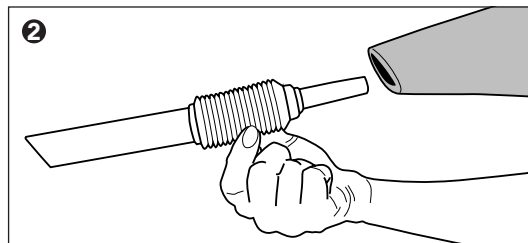

3. UPHOLSTERY BRUSH

This tool is used for picking up dirt and dust debris from upholstery, tables, etc. Attach the Upholstery Brush to your vacuum by pushing the tool firmly into the Bowl Nozzle with the brush facing down.

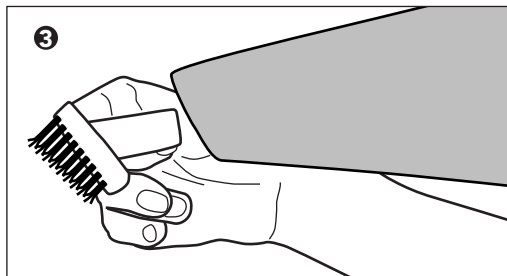

Your DirtTamer Supreme vacuum is equipped with a unique Dirt Finding Headlight which allows you to easily see dirt and dust under furniture or in dark corners.

The headlight will operate when the vacuum is switched "On".

REPLACEMENT LAMPS FOR HEADLIGHT

The lamp in your DirtTamer Supreme headlight will last for years of normal household use.

**For a replacement lamp,
please call us at 1-800-211-9607**

LAMP REPLACEMENT INSTRUCTIONS

1. Insert the tip of a flat head screwdriver into the slot at the front of the lamp and twist to remove the lamp cartridge.
2. Remove the used lamp cartridge with your fingers.
3. Insert a new replacement lamp cartridge. Use only a genuine FilterStream® V2400-LAMP lamp cartridge.

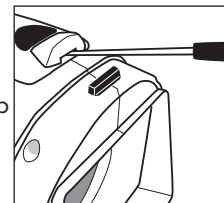

3-STAGE FILTRATION SYSTEM

Dirt Tamer Supreme has a revolutionary, patented 3-stage filtration system that provides superior suction for a longer period of time.

Stage 1: Large particles of debris are separated from liquids and air. The large particles remain in the Pre-Filter for easy disposal (see "Maintenance" section of this manual for Pre-Filter and Bowl emptying instructions).

Stage 2: Liquids and smaller dirt particles are separated from air and collected in the Bowl.

Stage 3: Fine dust/dirt particles are trapped by the standard Foam Filter (included), or, with the included HEPA filter, 99.97% of dust, pollen, bacteria and other allergens down to 0.3 microns in size can be captured.

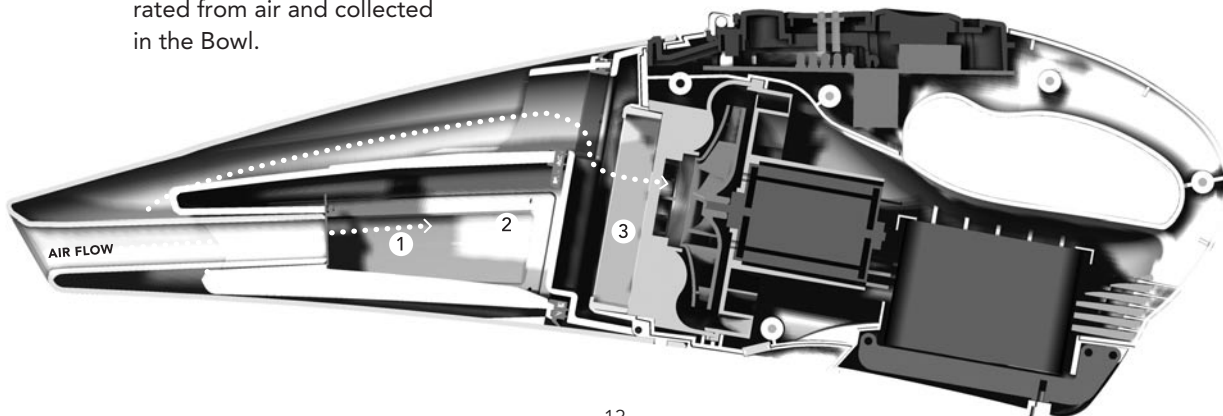

HOW TO USE

Remove your vacuum from the Charging Base and slide the On/Off Switch to the "On" position to operate. Slide the On/Off Switch to the "Off" position between cleaning tasks to conserve power.

PICKING UP DRY DEBRIS

Use your vacuum for picking up dirt, dust, food crumbs, etc. from counters, bare floors, rugs, automobile interiors, upholstered furniture, etc. After dry pickups, empty and clean the Bowl and Foam Filter before picking up liquid or wet spills.

Note: If using a HEPA Filter in place of the Foam Filter, shake loose, or brush off any dust or debris from the HEPA Filter if you notice any build-up.

DO NOT WASH OR RINSE THE HEPA FILTER, as this may damage the HEPA material.

If the HEPA Filter accidentally gets wet from vacuuming wet spills, remove the HEPA Filter, pat it dry with a paper towel, and allow it to thoroughly air dry before next use.

PICKING UP LIQUIDS OR WET DEBRIS

Use your vacuum to pick up liquids or wet debris. For ideal performance, we recommend the use of the Foam Filter for liquid debris.

- (a) For liquid pickups, insert the Squeegee into the Bowl Nozzle and pull the Squeegee through the liquid.
- (b) Do not fill the Bowl beyond the end of the Pre-Filter (about 9 oz. of liquid). If there is any liquid in the Bowl, hold the Bowl Nozzle down to avoid leakage. Tipping the Bowl Nozzle up may cause the liquid to enter the fan area.
- (c) After picking up perishable spills (e.g. milk, juice, etc.), empty your vacuum's Bowl and Pre-Filter immediately and thoroughly clean the Bowl, Pre-Filter, Filter Cover and Foam Filter to prevent mold and mildew from forming.



Your **DirtTamer Supreme V2400** vacuum will be more effective at cleaning up spills if you adhere to the following procedures:

CARPET CLEAN UPS

1. Immediately vacuum up as much of the spill as possible.
2. For oily spills, work some low sudsing carpet shampoo into the area according to the directions on the shampoo container (do not use solvent based cleaners). Vacuum up shampoo and spill residue, then proceed to step #3.
For water soluble spills, dampen the spill area using a spray bottle of cold, clean water. Be careful not to saturate the carpet.
3. Work water into the nap of the carpet.
4. Vacuum up water and spill residue.
5. Repeat the above procedure if necessary.
6. Cover the cleaned spill area with several layers of paper towels or a terry cloth towel. Step on the towels several times to soak up the moisture.
7. Brush up the nap of the carpet.

UPHOLSTERY CLEAN UPS

1. Immediately vacuum up as much of the spill as possible.
2. Follow your furniture manufacturer's instructions for spot cleaning upholstery.
Note: Never use flammable cleaners with your vacuum.

EMPTYING/CLEANING PRE-FILTER AND BOWL

Liquids, dirt and debris (wet and dry) picked up by your vacuum will collect in the Pre-Filter and Bowl. To empty/clean these parts, please follow these steps:

(a) Holding the Bowl with one hand and the Handle/Housing with the other, depress the Bowl Latch and swing the Bowl away from the Handle/Housing.

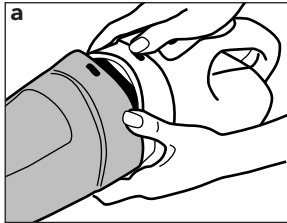

(b) While holding the Bowl in one hand, remove the Pre-Filter with your other hand by grasping the pull-tab on top of the Pre-Filter with your fingers. Empty any

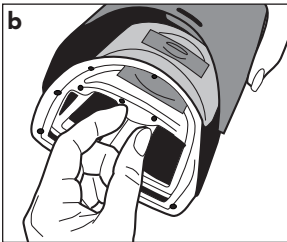

dirt, debris, or liquid from the Bowl and Pre-Filter into the sink or wastebasket.

(c) Rinse or hand wash the Pre-Filter, Bowl and Filter Cover with water (if needed, with warm, soapy water).

Note: The Pre-Filter, Bowl and Filter Cover can be washed in the dishwasher (top rack only).

(d) Allow the Pre-Filter, Bowl and Filter Cover to dry. Then reinsert the Pre-Filter into the Bowl, snap the Filter Cover onto the Handle/Housing, and reattach the Bowl to the Handle/Housing.

MAINTENANCE/FILTER REPLACEMENT

CLEANING/REPLACING FOAM AND HEPA FILTERS

To remove/replace the Filter (either foam or HEPA) from the vacuum, please follow these steps:

- (a) Remove the Filter Cover from the vacuum Handle/Housing.
- (b) Remove the Filter from the Handle/Housing.
- (c) Clean the Filter as follows.

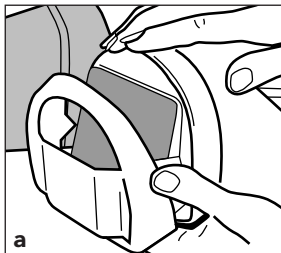

Foam Filter Cleaning:

Wash the Foam Filter in warm, soapy water until clean. Allow the Foam Filter to dry before reinserting into the Handle/Housing.

Note: Use only mild soap. Avoid detergents,

chemical cleaners or solvents as these may damage the plastic.

HEPA Filter Cleaning: Use your finger to lightly clean the paper surface of the HEPA Filter, clearing off any dirt, dust, and hair.

NOTE 1: Do not wash the HEPA Filter. Water will permanently damage the filter.

NOTE 2: Under normal household use, the HEPA filter will last six (6) months to one (1) year

(d) Insert either side of the clean Filter (or if necessary, a new Filter) into the Handle/Housing, then snap-on the Filter Cover and reattach the Bowl to the Handle/Housing (making sure that the Pre-Filter is inserted into the Bowl).

NOTE: Filters should be replaced periodically to provide best performance or when the filter has been damaged.

MAINTENANCE/FILTER REPLACEMENT

Your DirtTamer Supreme V2400 includes a standard Foam Filter for trapping fine dust and dirt particles, and a FilterStream® certified HEPA filter to trap microscopic particles that can aggravate allergies during vacuuming. With the HEPA filter, 99.97% of dust, pollen, bacteria, and other allergens down to 0.3 microns in size can be captured.

CLEANING THE VACUUM HOUSING

Clean the vacuum's Handle/Housing with a damp cloth. Never immerse the Handle/Housing in water.

**To order HEPA or Foam Filters,
please visit www.filterstream.com
or call 800-211-9607.**

Battery Removal and Disposal: This product uses a sealed lead acid battery. When the battery no longer recharges, it should be removed from the vacuum and recycled in accordance with state laws. The battery must not be incinerated or composted.

WARNING: In some areas, it is illegal to place used lead acid batteries in the trash or in municipal solid waste streams.

To remove the battery, follow these steps:

- (a) Use a Phillips screwdriver to unscrew the Battery Compartment retaining screw and remove the cover.

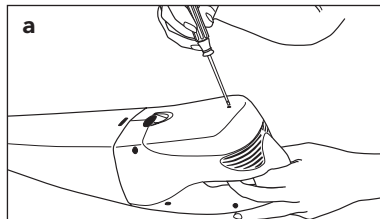

BATTERY REPLACEMENT

- (b) Remove the two rear screws from the Battery Bracket leaving the front screw in place.

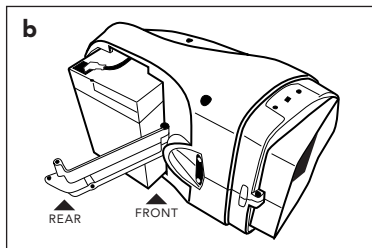

- (c) Pivot the Battery Bracket out of the battery's way so the battery can slide free from the bracket. If the battery has leaked or vented, protective gloves should be worn before touching the case. Remove the case by grasping the edges and sliding the battery out of the unit.
- (d) Unfasten the battery wire where the clips are connected.
- (e) When replacing the battery, ensure that the wires are not pinched against each other or between the battery and the housing.

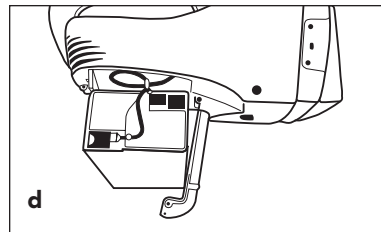
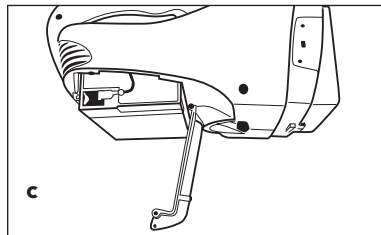

ACCESSORIES:

To order replacement parts,
please visit www.filterstream.com
or call 1-800-211-9607.

2 YEAR LIMITED WARRANTY

FilterStream Company warrants that this product is free from defects in materials or workmanship for a period of two (2) years from the date of original purchase.

If the product fails to operate in accordance with the manufacturer's specifications, simply return the product to the retail location where you purchased it where you purchased it or contact FilterStream customer service at service@filterstream.com or call 1-800-685-0710 to obtain an authorization number (RA#). Once you have been issued an authorization number, please return the defective product to us and we will, at our option, repair or replace the product and ship it back to you via postal mail or UPS at no charge.

This warranty does not cover damage resulting from accident, misuse or abuse, lack of reasonable care, the affixing of any attachment not provided with the product, or loss of parts, or subjecting the product to anything but the specified voltage or batteries.

THIS WARRANTY IS IN LIEU OF ANY OTHER WARRANTY, EXPRESS OR IMPLIED. ALL IMPLIED WARRANTIES, INCLUDING ANY IMPLIED WARRANTY OF MERCHANTABILITY OR FITNESS FOR ANY PARTICULAR PURPOSE, ARE LIMITED IN DURATION TO TWO (2) YEARS FROM THE DATE OF ORIGINAL PURCHASE. IN NO EVENT WILL FILTERSTREAM COMPANY BE RESPONSIBLE FOR INCIDENTAL, CONSEQUENTIAL, OR SPECIAL DAMAGES RESULTING FROM THE USE OF THIS PRODUCT.

Some states do not allow limitation on how long an implied warranty lasts and/or the exclusion or limitation of incidental or consequential damages, so the above limitation may not apply to you. This warranty gives you specific legal rights which vary from state to state.

To speak with a FilterStream Customer Service Representative, please call: 1-800-685-0710

Artwork #: 01 A200 21

**FILTERSTREAM COMPANY SERVICE CENTER, WWW.FILTERSTREAM.COM
P.O. BOX 526, MARBLEHEAD, MA USA 01945-0526**

Free Manuals Download Website

<http://myh66.com>

<http://usermanuals.us>

<http://www.somanuals.com>

<http://www.4manuals.cc>

<http://www.manual-lib.com>

<http://www.404manual.com>

<http://www.luxmanual.com>

<http://aubethermostatmanual.com>

Golf course search by state

<http://golfingnear.com>

Email search by domain

<http://emailbydomain.com>

Auto manuals search

<http://auto.somanuals.com>

TV manuals search

<http://tv.somanuals.com>