

OPERATING INSTRUCTIONS

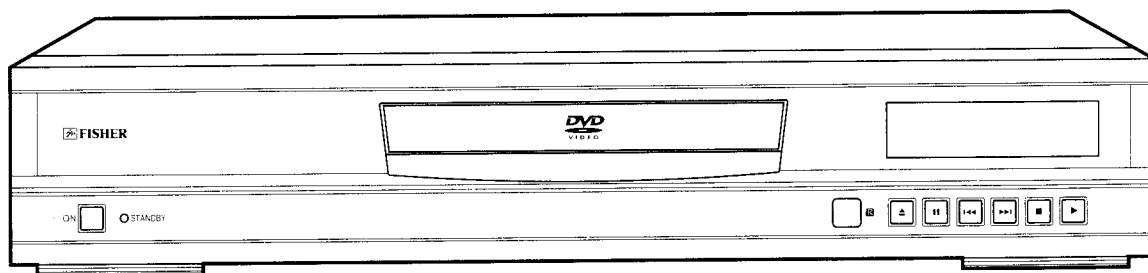

DVD-SL30

DVD Video Player

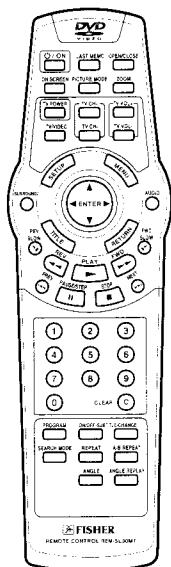

FISHER'S HELP-LINE

Call the toll-free number below if you have any difficulties operating this product.
1-800-421-5013 (Weekdays 8:00 AM - 5:00 PM Pacific Time)

CONTENTS

Safety Certification	E2	Frame by Frame Advance Playback [DVD]	E18
Accessories	E2	Picture Zoom [DVD]	E18
Controls	E3	Viewing from a Desired Camera Angle (Multi-Angle) [DVD]	E18
Multi-Brand TV Remote Control	E4	Angle Replay	E18
Before Connection	E6	Normal Repeat Playback	E19
Choosing a Connection	E6	Designated Range Repeat Playback (A-B Repeat)	E19
Basic Connections	E7	Programmed Playback [CD]	E20
Connecting to a TV (Example 1)	E7	Selecting Subtitle Language [DVD]	E21
Additional Connection Examples	E9	Selecting Audio Soundtrack Language (Multi-Language) [DVD]	E21
Connecting to an Audio System and TV (Example 2)	E9	Selecting On-Screen Information	E22
Connecting to an Amplifier with Dolby Digital Decoder, DTS Decoder, or MPEG2 Decoder (Example 3)	E10	Selecting Picture Mode	E22
Connecting to a Digital Amplifier (Example 4)	E10	Selecting Spatializer N-2-2™ Virtual Surround Sound Mode [DVD] [CD]	E22
Connecting to an Amplifier with Dolby Pro Logic Decoder (Example 5)	E11	MP3 CD Operation	E23
Power Supply	E11	MP3 CD Information	E23
For Safe and Efficient Operation	E11	MP3 CD Playback	E23
Playable Discs	E12	Stopping Playback	E24
Basic Operation	E13	Pause	E24
Before Starting	E13	File Skip	E24
Basic Playback	E13	Repeat Playback	E24
Stopping Playback	E14	TVGuardian® Operation	E25
Continuing Playback from Where You Stopped Watching (LAST MEMO PLAY) for DVD only	E14	Before Setting	E25
Chapter (Track) Skip	E14	Setting TVGuardian®	E25
Selecting a DVD Menu	E15	How It Works After Setting TVGuardian®	E26
Selecting a Title Menu [DVD]	E15	Initial Settings	E27
Title Search [DVD]	E16	Setting Language	E27
Chapter Search [DVD]	E16	Setting Display	E28
Time Search [DVD]	E16	Setting Digital Out	E28
Time Search [CD]	E16	Setting Parental	E29
Track Search [CD]	E16	Language Code List	E30
Fast Playback	E17	Troubleshooting Guide	E31
Slow Motion Playback [DVD]	E17	Maintenance	E32
Still Picture (Pause)	E17	Specifications	E32
		Warranty	E33

Please Read This Manual.

Because DVD is a new technology, we recommend that you read this manual carefully before connecting your DVD video player and operating it for the first time.

Keep the manual in a safe place for future reference.

IMPORTANT INFORMATION:

To connect this DVD video player to a TV, TV must have a set of Audio/Video composite input jacks (RCA-type). You cannot use an antenna terminal to connect this DVD video player.

To operate the built-in TVGuardian®



This unit has the built-in TVGuardian® Foul Language Filter (TVG®).



When a disc supporting closed caption is played, it will mute the audio during the entire phrase containing offensive language. For more details, see page E25.

To enjoy Dolby Digital sound

For connection, see "Connecting to an Amplifier with Dolby Digital Decoder, DTS Decoder or MPEG2 Decoder (Example 3)" on page E10.

See "Setting Digital Out" in the INITIAL SETTINGS on page E28.

	CAUTION RISK OF ELECTRIC SHOCK DO NOT OPEN	
CAUTION: TO PREVENT THE RISK OF ELECTRIC SHOCK, DO NOT REMOVE COVER (OR BACK). NO USER-SERVICEABLE PARTS INSIDE. REFER SERVICING TO QUALIFIED SERVICE PERSONNEL.		

	This symbol indicates that dangerous voltage constituting a risk of electric shock is present within this unit.
	This symbol indicates that there are important operating and maintenance instructions in the literature accompanying this unit.

WARNING: TO PREVENT FIRE OR SHOCK HAZARD, DO NOT EXPOSE THIS APPLIANCE TO RAIN OR MOISTURE.

WARNING: UNAUTHORIZED RECORDING OF COPYRIGHTED MATERIAL MAY VIOLATE APPLICABLE COPYRIGHT LAWS. THE MANUFACTURER ASSUMES NO RESPONSIBILITY FOR UNAUTHORIZED DUPLICATION, USE OR OTHER ACTS WHICH INFRINGE UPON THE RIGHTS OF COPYRIGHT OWNERS.

SAFETY CERTIFICATION

This unit is made and tested to meet exacting safety standards. It meets UL and FCC requirements and complies with safety performance standards of the U.S. Department of Health and Human Services.

CAUTION - USE OF CONTROLS OR ADJUSTMENTS OR PERFORMANCE OF PROCEDURES OTHER THAN THOSE SPECIFIED HEREIN MAY RESULT IN HAZARDOUS RADIATION EXPOSURE.

THIS UNIT SHOULD NOT BE ADJUSTED OR REPAIRED BY ANYONE EXCEPT PROPERLY QUALIFIED SERVICE PERSONNEL.

FCC INFORMATION

This device complies with Part 15 of the FCC Rules. Operation is subject to the following two conditions: (1) This device may not cause harmful interference, and (2) this device must accept any interference received, including interference that may cause undesired operation.

CAUTION:

Changes or modifications not expressly approved by Fisher may void the user's authority to operate this equipment.

Note:

This equipment has been tested and found to comply with the limits for a Class B digital device, pursuant to Part 15 of the FCC Rules. These limits are designed to provide reasonable protection against harmful interference in a residential installation. This equipment generates, uses and can radiate radio frequency energy and, if not installed and used in accordance with the instructions, may cause harmful interference to radio communications. However, there is no guarantee that interference will not occur in a particular installation. If this equipment does cause harmful interference to radio or television reception, which can be determined by turning the equipment off and on, the user is encouraged to try to correct the interference by one or more of the following measures:

- Reorient or relocate the receiving antenna.
- Increase the separation between the equipment and receiver.
- Connect the equipment into an outlet on a circuit different from that to which the receiver is connected.
- Consult the dealer or an experienced radio/TV technician for help.

ACCESSORIES

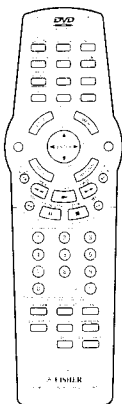

REM-SL30MT wireless remote control
Part No. 645 051 6047

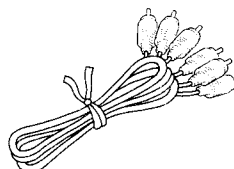

Audio/Video cable
Part No. 645 037 3893



CONTROLS

Front Panel

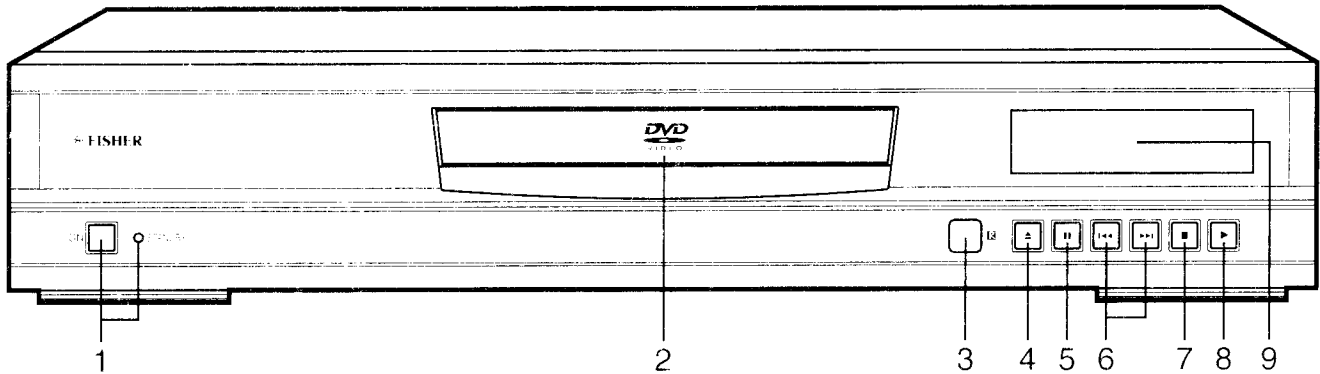

- | | |
|--|---|
| 1. Power button/Standby indicator (I/O, ON, STANDBY) | 6. Skip/Next/Previous buttons (I◀◀ ▶▶I) |
| 2. Disc tray | 7. Stop button (■) |
| 3. Remote sensor (IR) | 8. Play button (▶) |
| 4. Open/Close button (▲) | 9. FL Display |
| 5. Pause/Step button () | |

FL Display

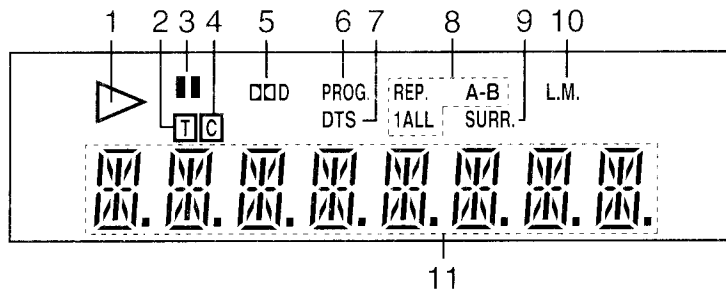

- | | |
|---|--|
| 1. Play indicator (▶) | 7. DTS indicator (DTS) |
| 2. Title and Track indicator (T) | 8. Repeat mode indicators (REP., 1, ALL, A-B) |
| 3. Pause indicator () | 9. Surround mode indicator (SURR.) |
| 4. Chapter indicator (C) | 10. Last memory indicator (L.M.) |
| 5. Dolby Digital indicator (Dolby Digital logo) | 11. Message or number indicators
(Title, chapter, track, playing time or other information) |
| 6. Program indicator (PROG.) | |

Rear Panel

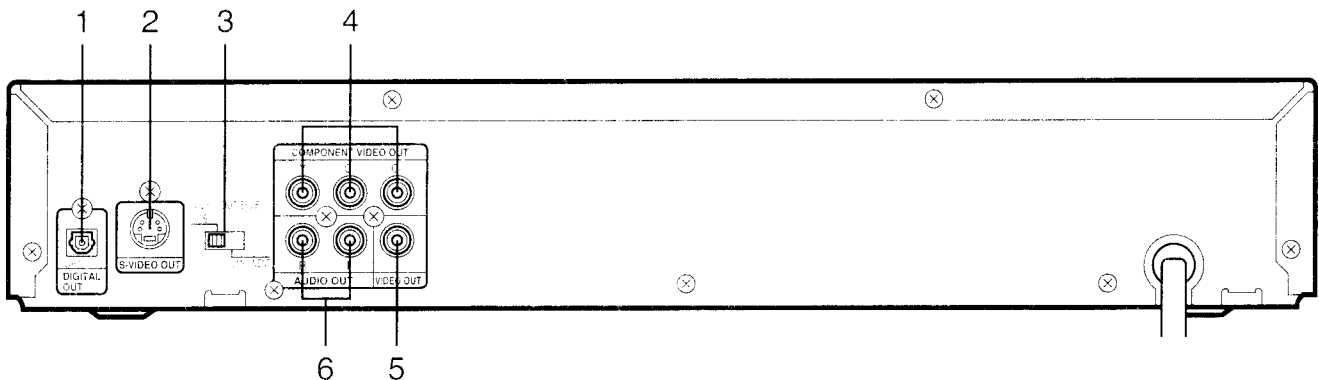

- | | |
|--|---|
| 1. Optical digital output jack (DIGITAL OUT) | 4. Component video output jacks (COMPONENT VIDEO OUT) |
| 2. S-Video output jack (S-VIDEO OUT) | 5. Video output jack (VIDEO OUT) |
| 3. Video output select switch (VIDEO OUT SELECT) | 6. Audio output jacks (AUDIO OUT) |

MULTI-BRAND TV REMOTE CONTROL

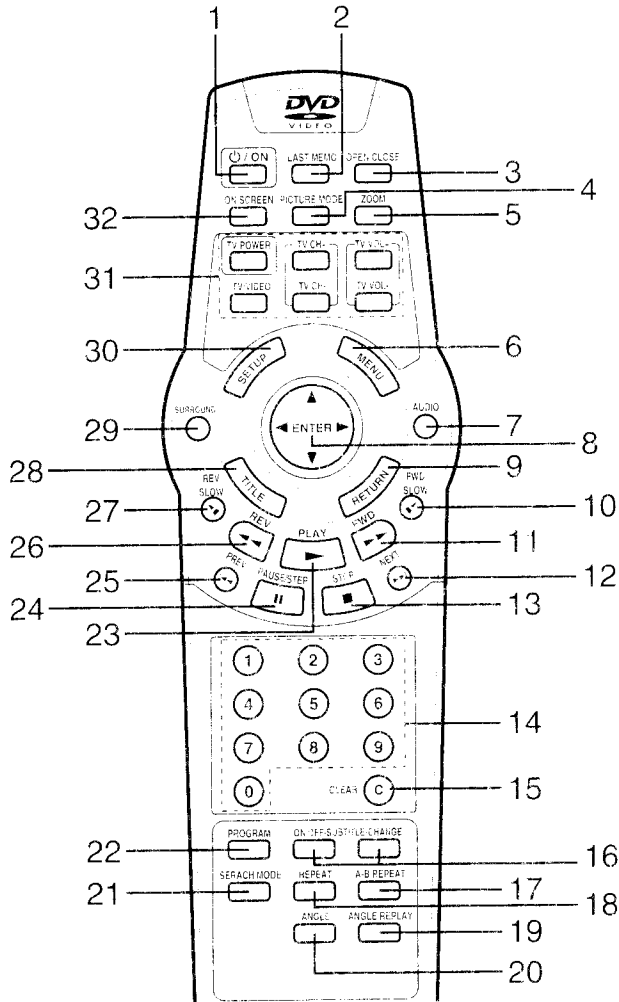

Controls

1. Power button (I/OFF)
2. Last memory button (LAST MEMO)
3. Open/Close button (OPEN/CLOSE)
4. Picture mode button (PICTURE MODE)
5. Zoom button (ZOOM)
6. Menu button (MENU)
7. Audio button (AUDIO)
8. Joy-stick (ENTER, ▲, ►, ▼, ◀)
9. Return button (RETURN) (See page E24.)
10. Forward slow button (FWD SLOW I▶)
11. Forward button (FWD ▶▶▶)
12. Skip/Next button (NEXT ▶▶▶i)
13. Stop button (STOP ■)
14. Number buttons (1 - 9, 0)
15. Clear button (CLEAR)
16. Subtitle On/Off and Change buttons (ON/OFF-SUBTITLE-CHANGE)
17. A-B repeat button (A-B REPEAT)
18. Repeat button (REPEAT)
19. Angle replay button (ANGLE REPLAY)
20. Angle button (ANGLE)
21. Search mode button (SEARCH MODE)
22. Program button (PROGRAM)
23. Play button (PLAY ▶)
24. Pause/Step button (PAUSE/STEP ||)
25. Skip/Previous button (PREV I◀◀)
26. Reverse button (REV ◀◀)
27. Reverse slow button (REV SLOW ◀I)
28. Title button (TITLE)
29. Surround sound button (SURROUND)
30. Setup button (SETUP)
31. TV control buttons
Power button (TV POWER)
TV/VIDEO select button (TV/VIDEO)
Channel scanning buttons (TV CH+, TV CH-)
Volume buttons (TV VOL+, TV VOL-)
32. On screen display button (ON SCREEN)

Inserting batteries

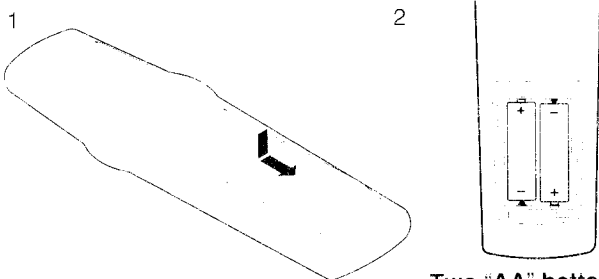

Two "AA" batteries
(not supplied)

Note:
Remove the batteries if the remote control is not to be used for a month or more. Batteries left in the unit may leak and cause damage.

IMPORTANT NOTE:

SPENT OR DISCHARGED BATTERIES MUST BE RECYCLED OR DISPOSED OF PROPERLY IN COMPLIANCE WITH ALL APPLICABLE LAWS. FOR DETAILED INFORMATION, CONTACT YOUR LOCAL COUNTY SOLID WASTE AUTHORITY.

Remote control range

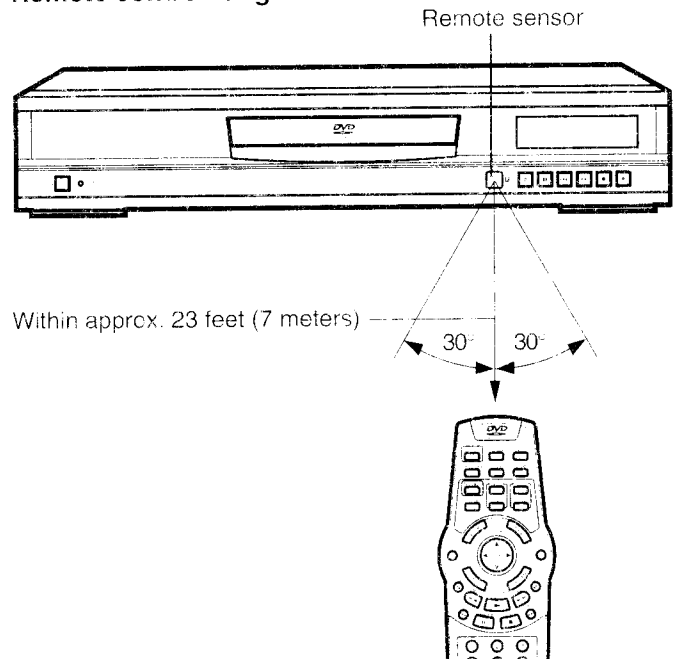

To set the remote control code for TV

This remote control can operate the basic functions of TVs made by the manufacturers listed below.

To enter the remote control code for your brand of TV, follow the steps below

1. In the chart below, find the code corresponding to your brand of TV.
2. While holding down [TV POWER], enter the 2-digit code using the number buttons [0 - 9], then release [TV POWER].
 - The remote control is now set to operate your TV.

TV brands	Code
ADMIRAL	05, 10, 13
EMERSON	17
FISHER	03
GE	07
GOLD STAR	01
HITACHI	02
JVC	15
MAGNAVOX	08
MATSUSHITA	12, 18
mitsubishi	14
PANASONIC	12, 18
QUASAR	12, 18
RCA	06
SAMSUNG	16
SANYO	03
SHARP	00, 13
SONY	11
TECHNOL ACE	05
TOSHIBA	04
ZENITH	09, 10

Notes on using the Joy-stick

The Joy-stick has five functions depending on the direction it is moved.

Press straight down: ENTER

Tilt towards the front: ▲

Tilt towards the right: ►

Tilt towards the back: ▼

Tilt towards the left: ◀

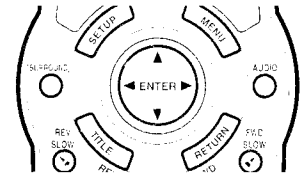

Note:

Control the stick using your thumb.

Notes:

- Only remote-controlled TVs can be operated using this remote control. (Refer to your TV instruction manual for more details.)
- There may be some older TV models that cannot be operated with this remote control. If this is the case, use the original remote control supplied with the TV.

IMPORTANT NOTE:

If the batteries in the remote control are changed, the code settings for the TV must be re-entered.

Write your code number below for future reference.

TV.



**Need help? Call
1-800-421-5013**

BEFORE CONNECTION

IMPORTANT INFORMATION:

- To connect this unit to a TV, TV must have a set of Audio/Video composite input jacks (RCA-type). You cannot use an antenna terminal to connect this unit.
- If your TV has only an antenna terminal, please purchase the TV with Audio/Video input jacks or the RF modulator.
- Do not connect the unit to a VCR directly. The playback picture will be distorted because DVD video discs are copy-protected.
- Please refer to the instruction manuals for the components that you are connecting (TV, AV amplifier, etc.).

Choosing a Connection

Does your TV have "Audio/Video input jacks"?

Yes

No

Do you use an RF Modulator (not supplied)?

Yes

See "Connecting to a TV (Example 1)" and "Using RF Modulator" on pages E7 & E8.

No

Please purchase the TV with Audio/Video input jacks or the RF Modulator.

TV Connection

Do you connect it to a TV?

Yes

See "Connecting to a TV (Example 1)" on page E7.

No

Do you connect it to an Audio System and a TV?

Yes

See "Connecting to an Audio System and TV (Example 2)" on page E9.

TV and Amplifier Connection

VIDEO Connection

See "Connecting to a TV (Example 1)" on page E7.

AUDIO Connection

Do you connect it to an Amplifier with Dolby Digital Decoder, DTS Decoder or MPEG2 Decoder?

Yes

See "Connecting to an Amplifier with Dolby Digital Decoder, DTS Decoder or MPEG2 Decoder (Example 3)" on page E10.

No

Do you connect it to a Digital Amplifier?

Yes

See "Connecting to a Digital Amplifier (Example 4)" on page E10.

No

Do you connect it to an Amplifier with Dolby Pro Logic Decoder?

Yes

See "Connecting to an Amplifier with Dolby Pro Logic Decoder (Example 5)" on page E11.

No

See "Connecting to a TV (Example 1)" on page E7.

**Need help? Call
1-800-421-5013**



BASIC CONNECTIONS

Connecting to a TV (Example 1)

Connect the DVD video player to your TV.
This is the easiest way to hook up the DVD video player.

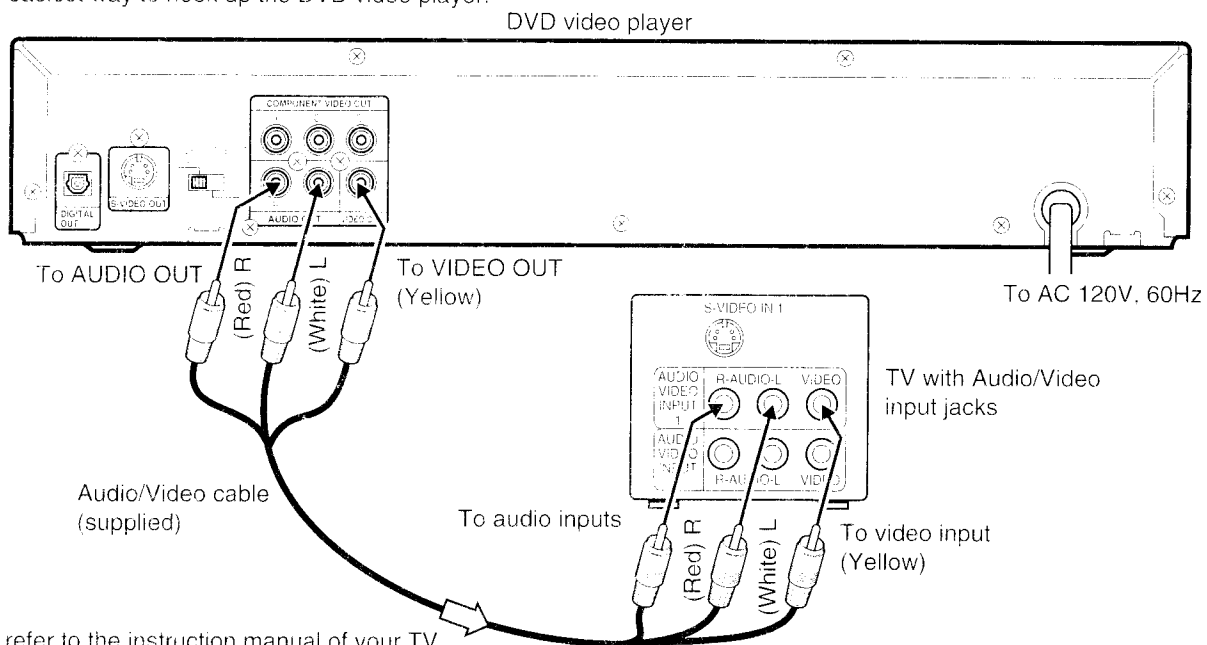

Notes:

- Please refer to the instruction manual of your TV.
- When you connect the DVD video player to your TV, be sure to turn off the power and disconnect both units from the wall outlet until all the connections have been made.
- If your TV has one audio input jack, connect the AUDIO OUT jacks of the DVD video player to a Y-cable adapter (not supplied), then connect it to the TV Audio input. Please consult your local audio/video dealer.
- Do not connect the DVD video player to a VCR directly. The playback picture will be distorted because DVD video discs are copy protected.

Note:

Please follow the steps before turn on the power.

1. If your TV has the S-video input jack, connect the DVD video player with the S-video cable (not supplied). (The VIDEO OUT jack connection is not necessary.) You can enjoy clearer picture playback.
2. Set the VIDEO OUT SELECT switch to the **S** position.
3. You also need to connect the left and right audio cables (not supplied) to the AUDIO OUT jacks of DVD video player and the Audio input jacks of the TV.

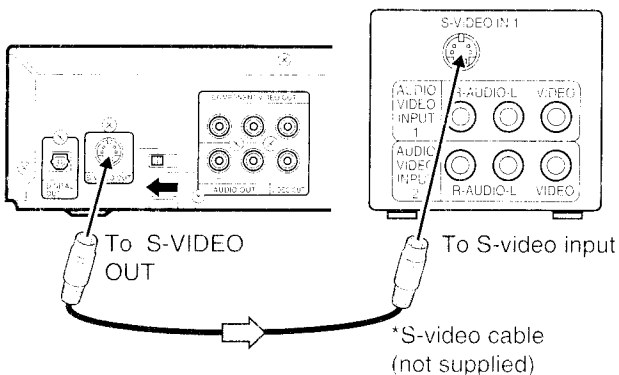

*Please consult your local audio/video dealer.



**Need help? Call
1-800-421-5013**

Note:

Please follow the steps before turn on the power.

1. If your TV has the component video input jacks, connect the DVD video player to these jacks. (The VIDEO OUT or S-VIDEO OUT jack connection is not necessary.) You can enjoy high quality picture playback.
2. Set the VIDEO OUT SELECT switch to the **COMPONENT** position.
3. You also need to connect the left and right audio cables (not supplied) to the AUDIO OUT jacks of DVD video player and the Audio input jacks of the TV.

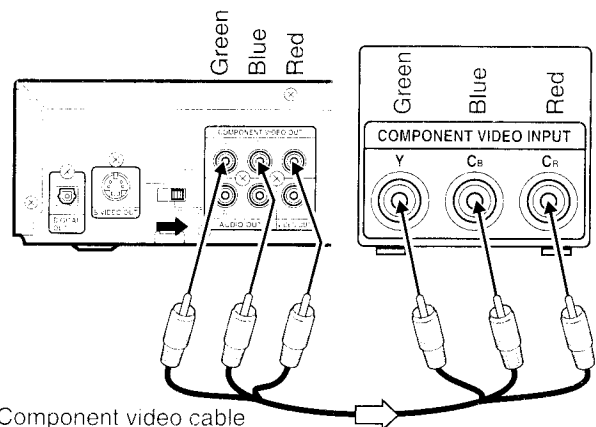

Using RF Modulator

If your TV does not have a Video input jack and has an antenna terminal only, please purchase the *RF Modulator (not supplied).
(*Please consult your audio/video dealer.)

Example: DVD video player, TV and RF Modulator connections

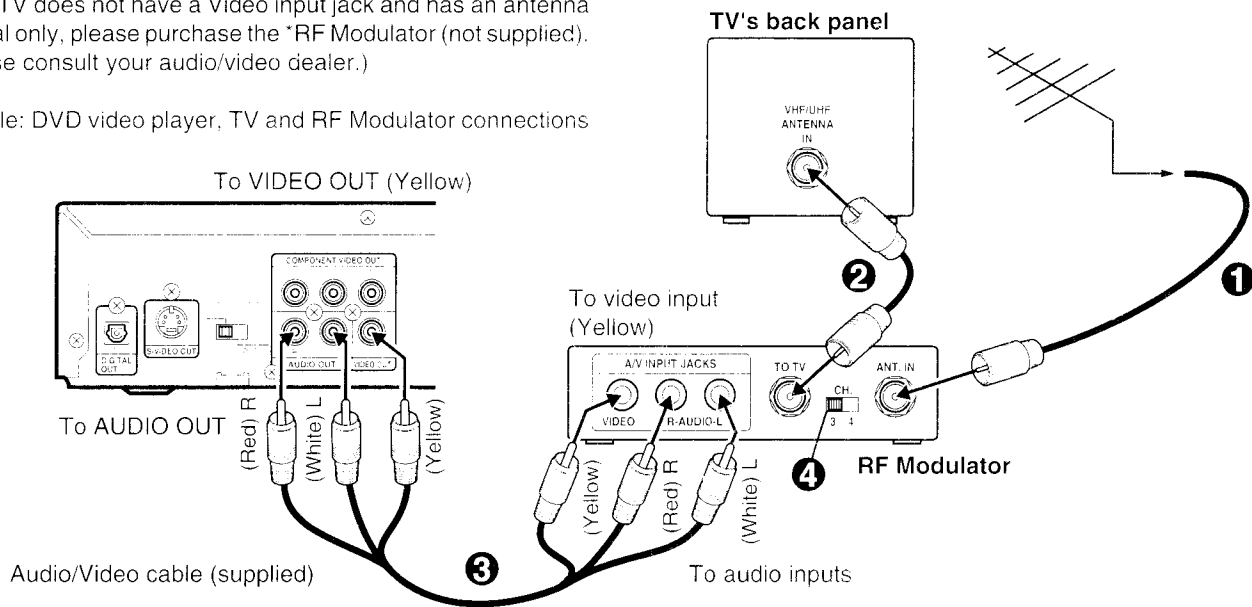

1. Connect the antenna cable (not supplied) to the ANT. IN terminal of the RF Modulator.
 2. Connect the 75-ohm coaxial cable (not supplied) between the TO TV terminal of the RF Modulator and the VHF/UHF ANTENNA IN terminal of the TV.
 3. Connect the Audio/Video cable (supplied) between the AUDIO OUT and VIDEO OUT jacks of the DVD video player and the AUDIO INPUT and VIDEO INPUT jacks of the RF Modulator.
 4. Turn on the TV, and set the channel number (CH3 or CH4) on both TV and RF Modulator, whichever is not used for regular broadcasts in your area.
- Note:
For more details, please refer to the instruction manual of the RF Modulator.

Example: DVD video player, VCR, TV and RF Modulator connections

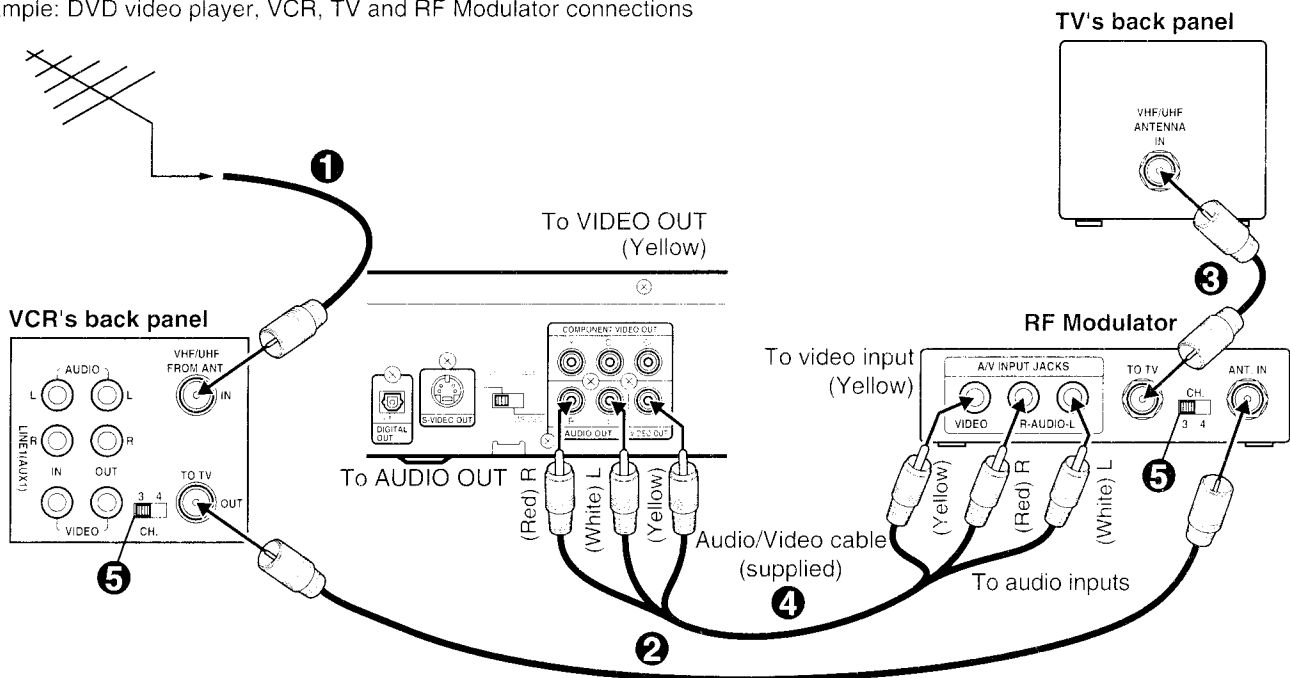

1. Connect the antenna cable (not supplied) to the VHF/UHF FROM ANT IN terminal of the VCR.
2. Connect the 75-ohm coaxial cable (not supplied) between the TO TV OUT terminal of the VCR and the ANT. IN terminal of the RF Modulator.
3. Connect the 75-ohm coaxial cable (not supplied) between the TO TV terminal of the RF Modulator and the VHF/UHF ANTENNA IN terminal of the TV.
4. Connect the Audio/Video cable (supplied) between the AUDIO OUT and VIDEO OUT jacks of the DVD video player and the AUDIO INPUT and VIDEO INPUT jacks of the RF Modulator.
5. Turn on the TV, and set the channel number (CH3 or CH4) on all TV, VCR and RF Modulator, whichever is not used for regular broadcasts in your area.

Note:
For more details, please refer to the instruction manual of the RF Modulator.

ADDITIONAL CONNECTION EXAMPLES

Connecting to an Audio System and TV (Example 2)

Connect the DVD video player to an Audio System and a TV.

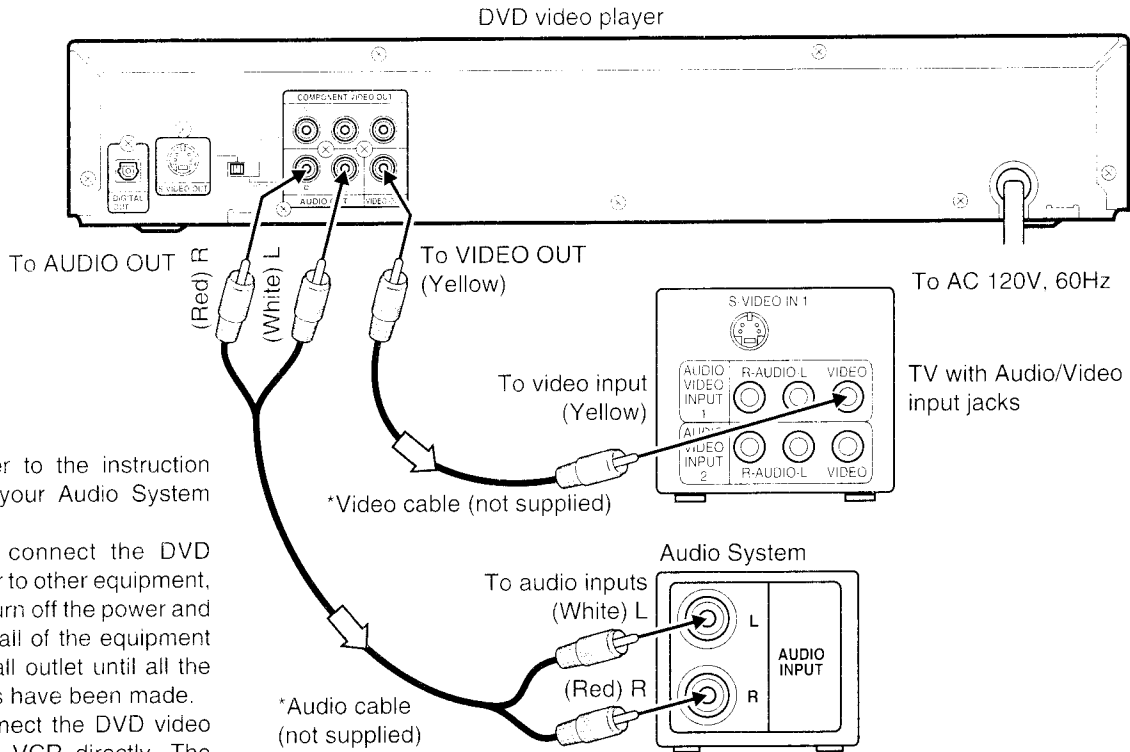

Notes:

- Please refer to the instruction manual of your Audio System and TV.
- When you connect the DVD video player to other equipment, be sure to turn off the power and disconnect all of the equipment from the wall outlet until all the connections have been made.
- Do not connect the DVD video player to a VCR directly. The playback picture will be distorted because DVD video discs are copy protected.

*Please consult your local audio/video dealer.

Note:

Please follow the steps before turn on the power.

1. If your TV has the S-video input jack, connect the DVD video player with the S-video cable (not supplied). (The VIDEO OUT jack connection is not necessary.) You can enjoy clearer picture playback.
2. Set the VIDEO OUT SELECT switch to the **S** position.
3. You also need to connect the left and right audio cables (not supplied) to the AUDIO OUT jacks of DVD video player and the Audio input jacks of the Audio System.

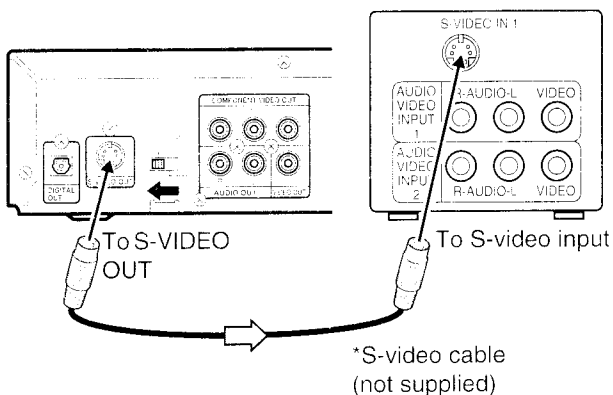

*Please consult your local audio/video dealer.

Note:

Please follow the steps before turn on the power.

1. If your TV has the component video input jacks, connect the DVD video player to these jacks. (The VIDEO OUT or S-VIDEO OUT jack connection is not necessary.) You can enjoy high quality picture playback.
2. Set the VIDEO OUT SELECT switch to the **COMPONENT** position.
3. You also need to connect the left and right audio cables (not supplied) to the AUDIO OUT jacks of DVD video player and the Audio input jacks of the Audio System.

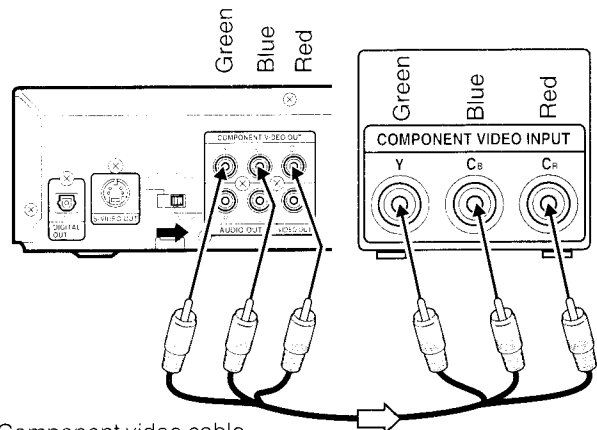

*Component video cable (not supplied)

Notes:

- For VIDEO connection, please refer to "BASIC CONNECTIONS" on page E7.
- Please refer to the instruction manual of your amplifier.
- When you connect the DVD video player to your amplifier, be sure to turn off the power and disconnect both units from the wall outlet until all the connections have been made.

Connecting to an Amplifier with Dolby Digital Decoder, DTS Decoder or MPEG2 Decoder (Example 3)

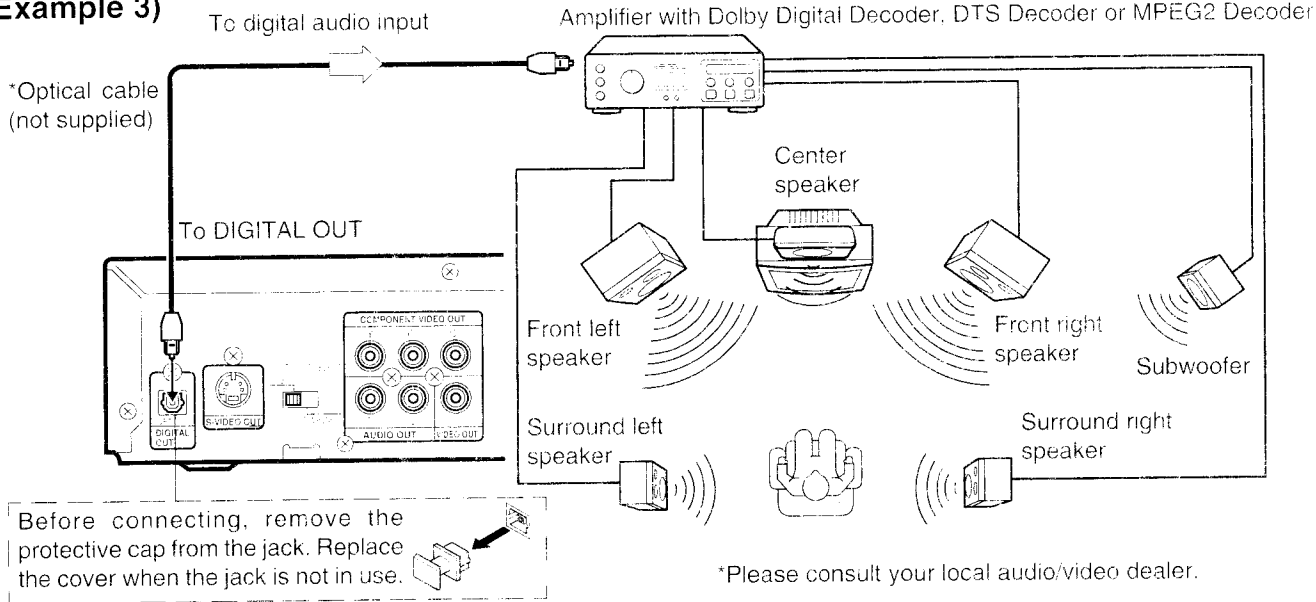

To enjoy Dolby Digital sound

Select "Dolby Digital: BitStream" in "Setting Digital Out" on the INITIAL SETTINGS. (See page E28.)

To enjoy DTS sound

Select "DTS: On" in "Setting Digital Out" on the INITIAL SETTINGS. (See page E28.)

To enjoy MPEG2 sound

Select "MPEG: BitStream" in "Setting Digital Out" on the INITIAL SETTINGS. (See page E28.)

Manufactured under license from Dolby Laboratories.

"Dolby", "Pro Logic" and the double-D symbol are trademarks of Dolby Laboratories.

"DTS" and "DTS Digital Out" are trademarks of Digital Theater Systems, Inc.



Need help? Call
1-800-421-5013

Connecting to a Digital Amplifier (Example 4)

You can enjoy 2 Channel Digital Stereo Sound.

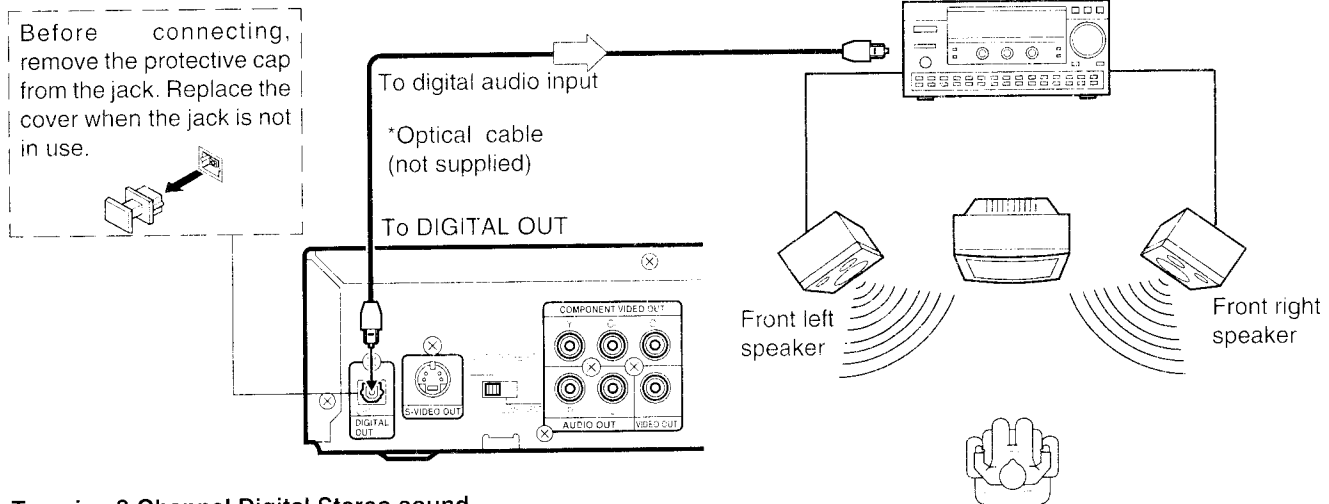

To enjoy 2 Channel Digital Stereo sound

Select "Dolby Digital: LPCM", "MPEG: LPCM", and "DTS: Off" in "Setting Digital Out" on the INITIAL SETTINGS. (See page E28.)

Note:

If "DTS: On" is selected, loud noise will occur. (See page E28.)

*Please consult your local audio/video dealer.



Connecting to an Amplifier with Dolby Pro Logic Decoder (Example 5)

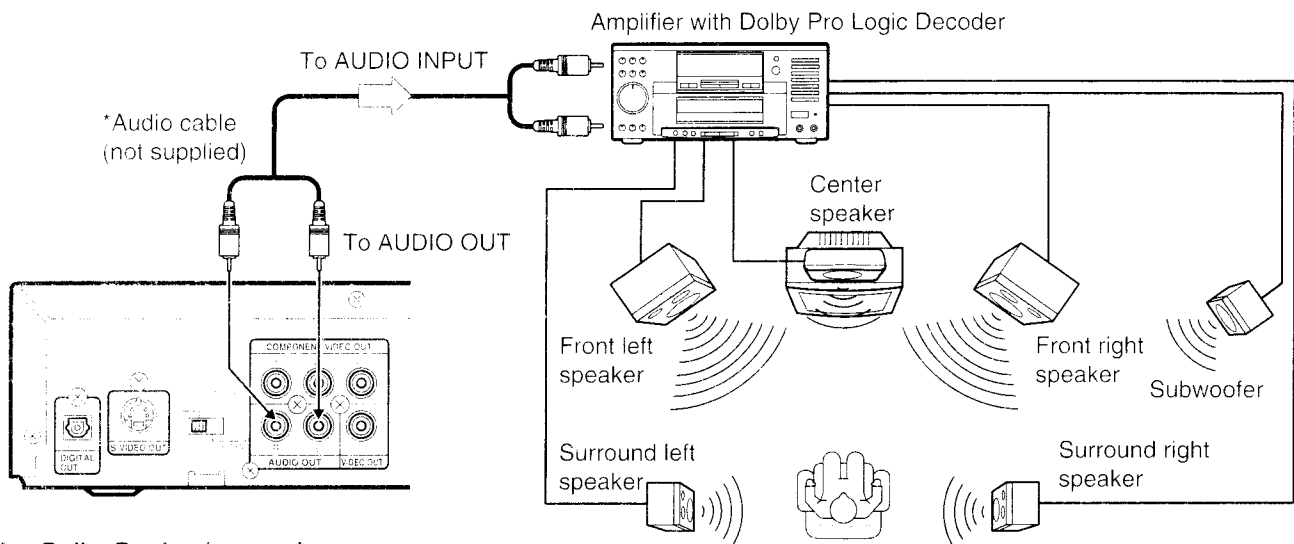

To enjoy Dolby Pro Logic sound

Select "Dolby Digital: LPCM" in "Setting Digital Out" on the INITIAL SETTINGS. (See page E28.)

Note:

Please refer to the instruction manual of your amplifier.

*Please consult your local audio/video dealer.

Power Supply

Connect the power cord to a 120VAC 60Hz outlet. This unit is equipped with a polarized plug. If you have difficulty inserting the plug, turn it over and reinsert it. If the unit will not be used for a long time, disconnect the AC plug from the AC outlet.

Notes:

- Before plugging the power cord into an AC outlet, make sure that all the connections have been made.
- The unit is not disconnected from the AC power unless the power cord is unplugged from the AC outlet.

CAUTION:

When connecting the DVD video player, follow the installation instructions in the attached "IMPORTANT SAFETY INSTRUCTIONS".



**Need help? Call
1-800-421-5013**



FOR SAFE AND EFFICIENT OPERATION

- Do not damage the power cord
- When not in use, disconnect the power cord from the outlet. Grasp the plug, not the cord, when disconnecting the unit.
- If water should enter the unit, electrical shock or a malfunction may result. Use in an area where there is low humidity and little dust.
- Do not disassemble or alter the unit in any way.
- Do not use the unit in areas where extremes in temperature occur (below 40° F (5° C) or exceeding 95° F (35° C)), or where it may be exposed to direct sunlight.
- Because of the DVD video player extremely low noise and wide dynamic range, there is a tendency to set the volume on the amplifier higher than necessary. Doing so may produce an excessively high output from the amplifier which can cause damage to your speakers. Please be careful in this regard.
- Sudden changes in the surrounding temperature can cause dew to form on the optical pickup lens inside the unit. Under this condition the unit may be unable to operate properly. If this should occur, remove the disc and allow the unit to adjust to the surrounding temperature.
- **When carrying the unit, be sure to remove a disc which may be inside and turn the power off. Then unplug the power cord from the AC outlet after 10 seconds. Carrying the unit with a disc inside may damage the disc and/or the unit.**
- The unit is automatically set to the standby mode after approximately 30 minutes have elapsed under the complete stop mode.

Press [OPEN/CLOSE] (or [▲] on the DVD video player) when closing the disc tray. Do not push the disc tray.

PLAYABLE DISCS

The following types of discs can be played on this unit.

Disc type and logo mark		Recorded content	Disc size	Maximum playing time
DVD Video		Audio + Video	5 inches (12 cm)	Approx. 4 hours (Single sided disc) Approx. 8 hours (Double sided disc)
			3 inches (8 cm)	Approx. 80 minutes (Single sided disc) Approx. 160 minutes (Double sided disc)
Music CD		Audio	5 inches (12 cm)	74 minutes
			3 inches (8 cm)	20 minutes

Region Number

Region number (Regional restriction code) is built-in to the DVD video player and DVD video discs.

Region number "1" or "ALL" of DVD video discs can be used on this unit.



DVD Video Disc

There are the marks on some DVD video disc package.

Examples:



Multiple languages



Multi-language subtitles



Multi-angle

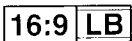

Multi-aspect



Region number



Closed caption

CAUTION:

- Only the above types of discs can be played on this unit. DVD-ROM, CD-ROM, SVCD, CVD, VCD, etc. cannot be played.
- This unit can play back the DVD-R that has recorded movie data as well. However, some DVD-Rs can not be played back depending on the recording conditions.
- The DVD-R that has no movie data can not be played back.
- This unit is to be used exclusively with the NTSC color system. PAL and SECAM system discs cannot be used with this unit.
- **For MP3 CD, please see page E23.**

DVD Video Disc

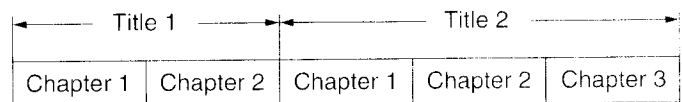

DVD video discs are divided into titles, and the titles are sub-divided into chapters.

Music CD Disc

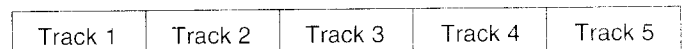

Music CD discs are divided into tracks.

Handling, Storing and Cleaning Discs

- Fingerprints and dust should be carefully wiped from the signal surface of the disc (glossy side) with a soft cloth. Wipe in a straight motion from the center to the outside of the disc.
- Never use chemicals such as record cleaning sprays, antistatic sprays or fluids, benzene or thinner to clean the discs. These chemicals will permanently damage the plastic surface of the disc.
- To remove a disc from its storage case, press down on the center of the case and lift the disc out, holding it carefully by the edges.

- Discs should be returned to their cases after use to protect them from dust and scratches.
- To prevent warping the disc, do not expose it to direct sunlight, high humidity or high temperatures for extended periods of time.
- Do not apply paper or write anything on either side of the disc. Sharp writing instruments, or the inks used in some felt-tip pens, may damage the surfaces of the disc.

BASIC OPERATION

Before Starting

- Turn on the power (TV, Audio system, AV amplifier, etc.).
- **Select the video input source from your television.**
(Refer to your TV owner's manual.)

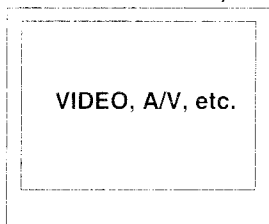

- Select the playback picture size according to the aspect ratio of the TV. (For more details, see "Setting Display" on page E28.)

4:3 LB

(Letterbox):

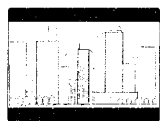

4:3 PS

(Panscan):

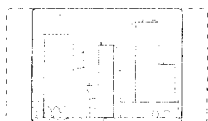

16:9 :

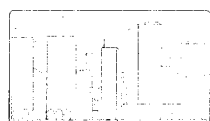

- Select the audio input source (Audio system, AV amplifier, etc.).

Basic Playback

Notes:

- Do not touch the disc tray while it is moving.
- Never place anything except a disc on the disc tray. Foreign objects can damage the unit.
- Do not apply excessive force to the disc tray.
- Discs must be placed on the disc tray one at a time.

When operation buttons are pressed, that operation is displayed on the TV screen. The display turns off after several seconds.

1. Press [ON/OFF].
 - The STANDBY indicator turns off.
 - "FISHER" logo appears on the TV screen.
 - "NO DISC" appears on the FL display.
2. Press [OPEN/CLOSE] (or [▲]) on the DVD video player).
 - "OPEN" appears on the FL display and the disc tray opens.

Note:

To open or close the disc tray, be sure to press [OPEN/CLOSE] (or [▲]). Do not press the disc tray with your hand.

3. Place the disc with the label facing up on the disc tray.

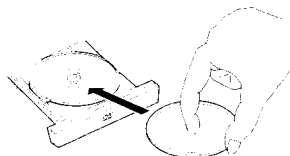

or

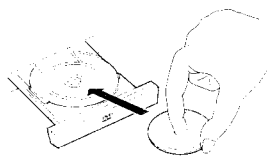

For 5-inch (12cm) disc

For 3-inch (8cm) disc

4. Press [OPEN/CLOSE] (or [▲]) again.
The disc tray closes. "READING" appears on the FL display.
Note:
Some discs may start playback automatically.

Important Note:

- This instruction manual explains the basic instruction of this DVD video player using the remote control unit.
- Some DVD video discs have different functions that may not be explained in this instruction manual. You may need extra instructions. In this case, please follow the instructions displayed on the TV screen or jacket or case of the disc.
- "⊘" may appear on the TV screen during operation. This icon means that the function is not available on the disc now.
- For improvement, on-screen displays subject to change without notice.

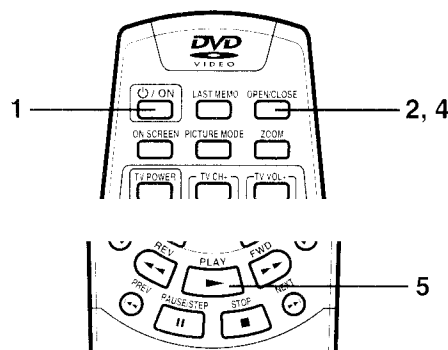
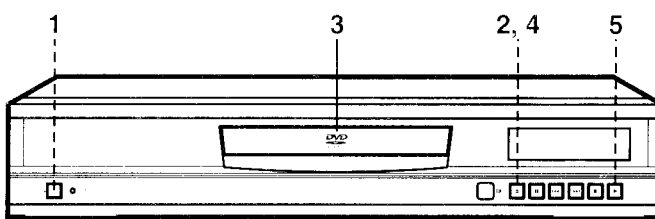

5. Press [PLAY ▶] (or [▶] on the DVD video player) to start playback.
 - "▶" appears.

Example:

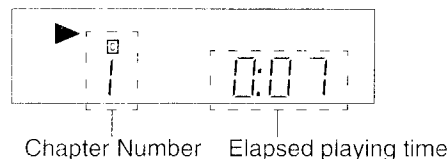

Chapter Number Elapsed playing time

Notes:

- In some discs, even if 4:3 PS is selected, the black bands may remain on the screen.
- If the disc is loaded with the label side downward (and it is a single sided disc), or if a badly scratched disc is loaded, "NO DISC" (or "NO PLAY") appears. If this occurs, load the disc correctly or replace the disc.

If a DVD disc menu appears on the TV screen...

Select the desired menu by pressing [▲], [▶], [▼] or [◀] (or the number buttons), then press [ENTER]. Playback of the selected menu starts.

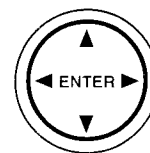

Note:

For more details, please refer to the jacket or case of the disc.

Stopping Playback

- Press [STOP ■] (or [■] on the DVD video player) once during playback. "Resume ■" appears briefly on the TV screen. When you press [PLAY ►] (or [►]), playback starts automatically from the point where you stopped. "►" appears briefly on the TV screen.

Note:

Some discs may not resume playback.

- Press [STOP ■] (or [■]) twice during playback. "■" briefly appears on the TV screen and playback stops completely. When you press [PLAY ►] (or [►]), playback starts from the beginning of the disc.

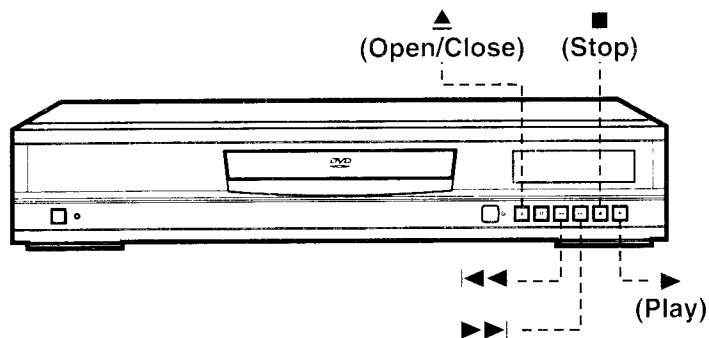

Continuing Playback from Where You Stopped Watching (LAST MEMO PLAY), for DVD only

- Press [LAST MEMO] to stop playback. "Last Memo ■" appears briefly on the TV screen. "L.M." appears on the FL display.
- Press [OPEN/CLOSE] to open the disc tray to change the disc, or press [P/ON] to turn off the power.
- Load the disc (or press [PLAY ►]), or press [P/ON] again. "Last Memory Play?" appears on the TV screen.
 - Yes
 - No
 - Clear ... (The memory is released.)
- Use [▲] to select "Yes".
- Press [ENTER]. Playback resumes from the point where you stopped. If desired, press [LAST MEMO] again.

Notes:

- Point on up to 3 discs can be memorized.
- The Last Memo Play mode may not work correctly with some discs.

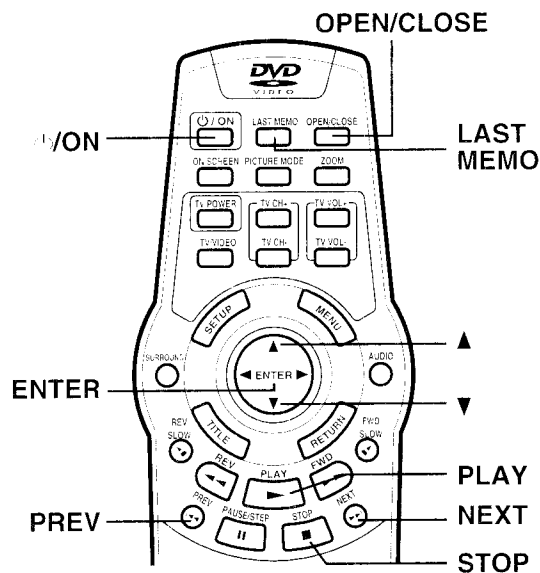

Chapter (Track) Skip

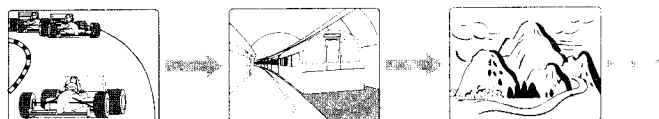

Skipping forward

Press [NEXT ►►] (or [►►]) during playback to skip to the next chapter (or track).

"►►" appears briefly on the TV screen.

A chapter (or track) is skipped each time the button is pressed.

Skipping backward

Press [PREV ◀◀] (or [◀◀]) during playback to skip back to the beginning of the chapter (or track) currently play.

"◀◀" appears briefly on the TV screen.

Press the button again immediately to skip back to the beginning of the previous chapter (or track).

Note:

You can skip only through the chapters, not over the title on the DVD disc.

This product incorporates copyright protection technology that is protected by method claims of certain U.S. patents and other intellectual property rights owned by Macrovision Corporation and other rights owners. Use of this copyright protection technology must be authorized by Macrovision Corporation, and is intended for home and other limited viewing uses only unless otherwise authorized by Macrovision Corporation. Reverse engineering or disassembly is prohibited.



Selecting a DVD Menu

Notes:

- The operation may differ depending on the disc used.
- Selecting a menu may not be possible on some discs.

1. Press [MENU].
The main menu screen will appear.

Note:

Press [MENU] again to resume playback.

2. Press [▲], [▼], [◀] or [▶] (or the number buttons) to select the desired menu.
3. Press [ENTER]
The selected menu playback starts.

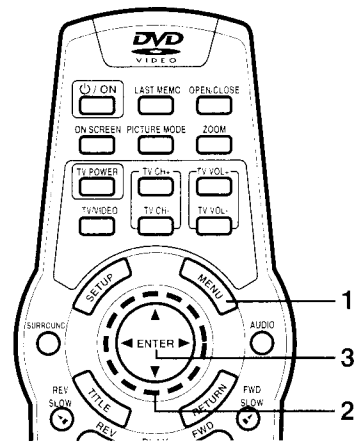

Selecting a Title Menu [DVD]

Notes:

- The operation may differ depending on the disc used.
- Selecting a title may not be possible on some discs.

1. Press [TITLE].
The title menu will appear (if the disc contains a title menu).
2. Press [▲], [▼], [◀] or [▶] (or the number buttons) to select the desired title.
3. Press [ENTER].
The selected title playback starts.

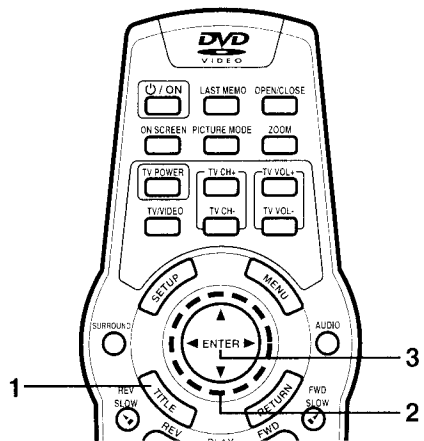

Important Note:

“⊘” may appear on the TV screen during operation. This icon means that the function is not available on the disc now.



**Need help? Call
1-800-421-5013**

Title Search [DVD]

1. Press [SEARCH MODE] once during playback or in the stop mode.
The title search screen appears on the TV screen.
Example:
Title Search --/02
2. Press the number button(s) to enter the title number.
Example:
To select Title No.3, press [3].
To select Title No.10, press [1], then [0].
To select Title No.24, press [2], then [4].
Note:
If you make a mistake, press [CLEAR].
3. Press [PLAY ►].
Playback starts from the selected title.

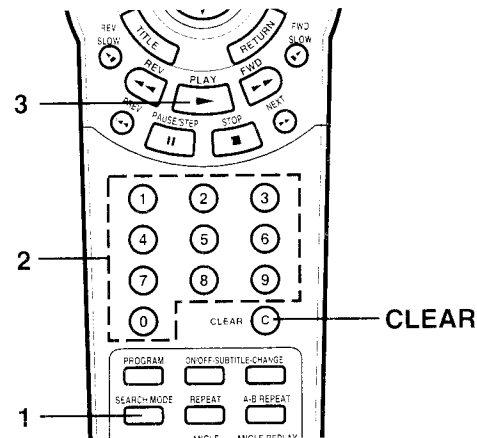

Chapter Search [DVD]

1. Press [SEARCH MODE] twice during playback.
The chapter search screen appears on the TV screen.
Example:
Title 01 Chapter Search --/35
2. Press the number button(s) to enter the chapter number.
Example:
To select Chapter No.3, press [3].
To select Chapter No.10, press [1], then [0].
To select Chapter No.24, press [2], then [4].
Note:
If you make a mistake, press [CLEAR].
3. Press [PLAY ►].
Playback starts from the selected chapter .

Time Search [CD]

1. Press [SEARCH MODE] once during playback.
The time search screen appears on the TV screen.
Example:
Time Search --:--:--
2. Press the number button(s) to enter the time.
Example:
2 minutes 5 seconds Press [2], [0] and [5].
42 minutes 39 seconds Press [4], [2], [3] and [9].
Note:
If you make a mistake, press [CLEAR].
3. Press [PLAY ►].
Playback starts from the searched time in the track.

Time Search [DVD]

1. Press [SEARCH MODE] three times during playback.
The time search screen appears on the TV screen.
Example:
Time Search --:--:--
2. Press the number button(s) to enter the time.
Example:
20 minutes 5 seconds Press [2], [0], [0] and [5].
42 minutes 39 seconds Press [4], [2], [3] and [9].
1 hour 4 minutes 35 seconds Press [1], [0], [4], [3] and [5].
Note:
If you make a mistake, press [CLEAR].
3. Press [PLAY ►].
Playback starts from the searched time.

Track Search [CD]

1. Press the number buttons during playback or in the stop mode.
Example:
To select Track No. 3, press [3].
To select Track No. 10, press [1], then [0].
To select Track No. 24, press [2], then [4].
2. Press [PLAY ►].
Playback starts from the selected track.

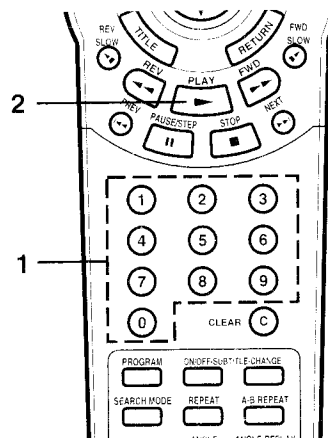

Fast Playback

Fast forward playback

Press [FWD ►►] repeatedly to select the fast speed forward playback.

[DVD]

►► 1 → ►► 2 → ►► 3 → ►► 4 (4 steps)

[CD]

►► 1 → ►► 2 (2 steps)

Press [PLAY ►] to return to normal playback.

Fast reverse playback

Press [REV ◀◀] repeatedly to select the fast speed reverse playback.

[DVD]

◀◀ 1 → ◀◀ 2 → ◀◀ 3 → ◀◀ 4 (4 steps)

[CD]

◀◀ 1 → ◀◀ 2 (2 steps)

Press [PLAY ►] to return to normal playback.

Note:

The sound is muted during fast playback in DVD.

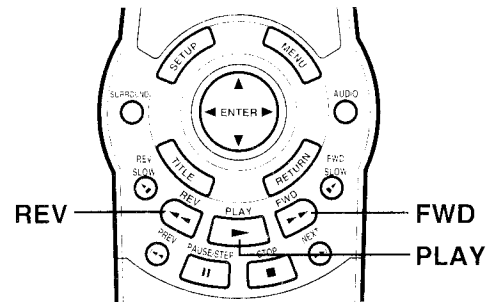

Slow Motion Playback [DVD]

Forward slow playback

Press [FWD SLOW I►] repeatedly to select the forward slow speed playback.

I► 1 → I► 2 → I► 3 → I► 4 (4 steps)

Press [PLAY ►] to return to normal playback.

Reverse slow playback

Press [REV SLOW ◀I] repeatedly to select the reverse slow speed playback.

◀I 1 → ◀I 2 → ◀I 3 → ◀I 4 (4 steps)

Press [PLAY ►] to return to normal playback.

Note:

The sound is muted during slow motion playback.

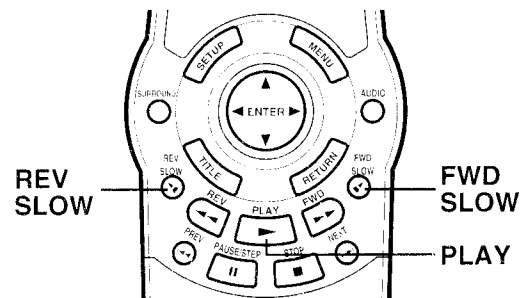

Important Note:

“⊘” may appear on the TV screen during operation. This icon means that the function is not available on the disc now.

Still Picture (Pause)

Press [PAUSE/STEP II] during playback.

- “II” appears on the FL display.
- “II” appears briefly on the TV screen.

Press [PLAY ►] to return to normal playback.

[DVD]

Still picture mode

[CD]

Pause mode

Note: The sound is muted.

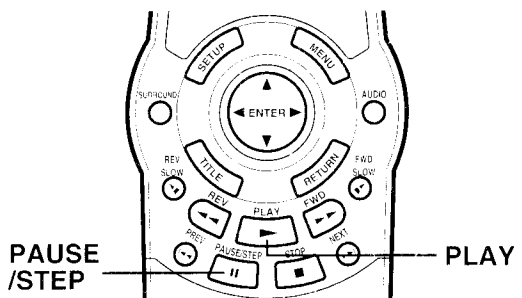

Need help? Call
1-800-421-5013

Frame by Frame Advance Playback

[DVD]

Press [PAUSE/STEP II] during still picture.

- "II" appears briefly on the TV screen.

Each time the button is pressed, the picture advances one frame.

Press [PLAY ►] to return to normal playback.

Notes:

- The sound is muted.
- Frame playback is operated forward only.

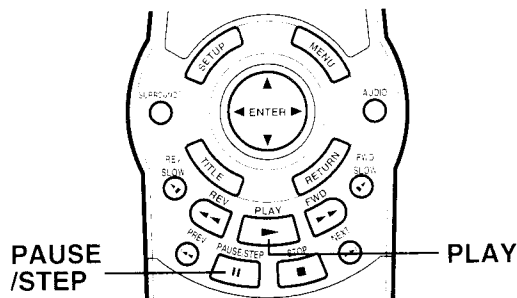

Picture Zoom [DVD]

1. Press [ZOOM] during normal/slow playback or still picture. The central part of the picture is magnified, and "Q 1" appears on the TV screen.

- Each time the button is pressed, the zoom mode will be changed as follows:

Q 1 → Q 2 → Q Off

- Press [▲], [▶], [▼] or [◀] to change the zoom point.

2. Press [ZOOM] to select "Q Off" to return to the original screen.

Note:

Picture Zoom may not work on some discs.

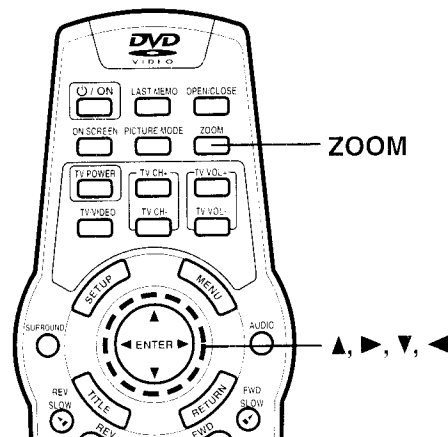

Viewing from a Desired Camera Angle (Multi-Angle) [DVD]

Some DVD video discs may contain scenes which have been shot simultaneously from a number of different camera angles. The jacket or case of discs that are recorded with angles will be marked.

Example:



Note:

The recorded angles differ depending on the disc used.

1. Play the disc that is recorded with angles.
2. Press [ANGLE] repeatedly until the desired angle appears.

Example:



Angle Replay

During Multi-angle playback screen, press [ANGLE REPLAY]. The player skips back to last approximately 10 seconds, changes it to the next camera angle and plays it, and continues playback. If desired, press the button again.

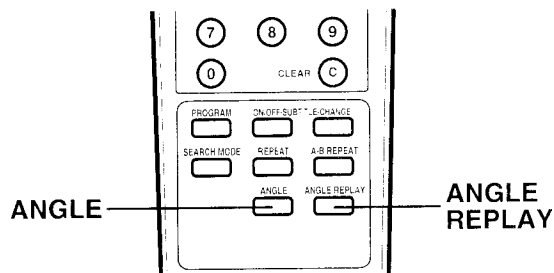
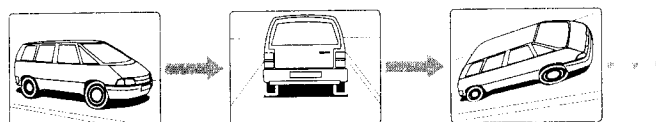

Important Note:

"⊘" may appear on the TV screen during operation. This icon means that the function is not available on the disc now.



Need help? Call
1-800-421-5013

Normal Repeat Playback

Press [REPEAT] during playback (or programmed play) of the title (or track) you want to repeat.

Each time the button is pressed, the repeat mode will be changed as follows.

[DVD]

- ↻ Chapter (REP. 1): Repeat of chapter being played
- ↻ Title (REP. ALL): Repeat of title being played
- ↻ Off: Normal playback mode

[CD]

- ↻ 1 (REP. 1): Repeat of track being played
- ↻ All (REP. ALL): Repeat all tracks
- ↻ Off: Normal playback mode

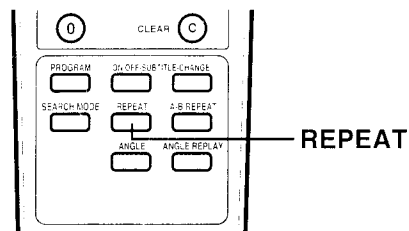

Designated Range Repeat Playback (A-B Repeat)

1. Press [A-B REPEAT] during playback at the beginning of the section you want to repeat (Point A).
 - "A-" appears on the TV screen.
 - "A-B" blinks on the FL display.
2. Press [A-B REPEAT] again at the end of the section you want to repeat (Point B).
 - "B" appears briefly on the TV screen.
 - "A-B" remains lit on the FL display.The section between points A and B is played repeatedly.
3. To return to normal playback, press [A-B REPEAT] again.
 - "Off" appears briefly on the TV screen.

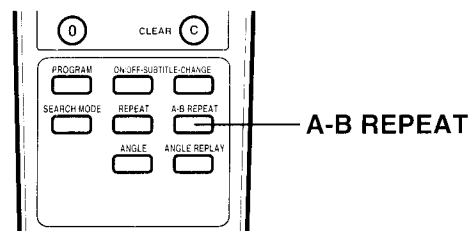
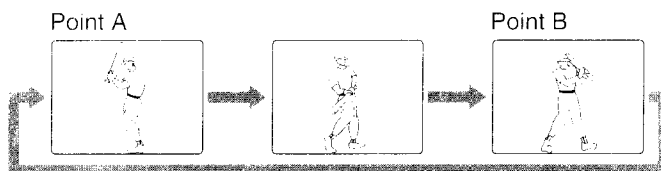

Note:

Normal repeat playback or A-B repeat playback mode may not work correctly with some discs.

Important Note:

"⊘" may appear on the TV screen during operation. This icon means that the function is not available on the disc now.



**Need help? Call
1-800-421-5013**

Programmed Playback [CD]

Up to 20 selections can be programmed.

Programming procedure

1. Press [PROGRAM] in the stop mode.
 - "Program Mode" screen appears.
2. Press the number buttons to select the track number.
Example:
To select Track No.3, press [0], then [3].
To select Track No.10, press [1], then [0].
To select Track No.24, press [2], then [4].
Notes:
 - If you make a mistake, press [CLEAR].
 - To quit the "Program Mode" screen, press [PROGRAM].

3. Press [▼] to move the highlighted box down.

Example:

Program Mode			
All Clear			
1	03	6 --	11 -- 16 --
2	--	7 --	12 -- 17 --
3	--	8 --	13 -- 18 --
4	--	9 --	14 -- 19 --
5	--	10 --	15 -- 20 --

4. Repeat step 2 and 3 above to select another track.
5. Press [PLAY ►] to start playback.
 - "PROG." remains lit.When all programmed selections have played, the player stops automatically.
 - The program contents are retained in memory.

Note:

To play the program again, press [PROGRAM] to call up the program screen, then press [PLAY ►].

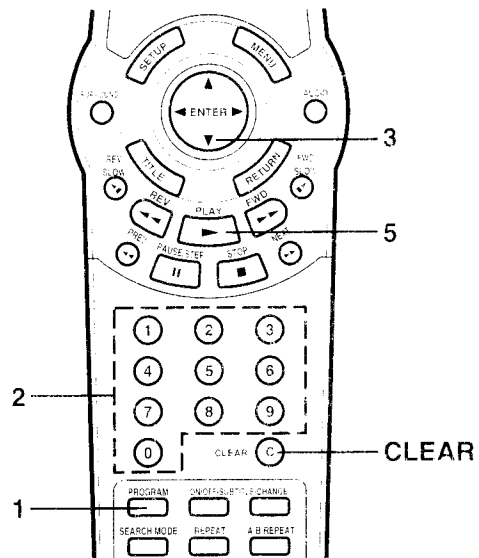

To clear the program one by one

1. Press [PROGRAM] to display the "Program Mode" screen.
2. Press [▲] or [▼] to select the track number.
3. Press [CLEAR].

To clear all the programs

1. Press [PROGRAM] to display the "Program Mode" screen.
2. Press [▲] to select "All Clear".
3. Press [ENTER].

To change the program

1. Press [PROGRAM] to display the "Program Mode" screen.
2. Press [▲] or [▼] to select the track number.
3. Press the number buttons to select the track number to be replaced.

Note:

To quit the "Program Mode" screen, press [PROGRAM].



Need help? Call
1-800-421-5013

Selecting Subtitle Language [DVD]

This operation works only with discs on which multiple subtitle languages are recorded.

1. Press [ON/OFF-SUBTITLE] during playback.
The subtitle language mark appears. (Example: 2/3 en)
If " Off" appears, press the button again.
2. Press [SUBTITLE-CHANGE] repeatedly until the desired subtitle language appears on the TV screen.
After few seconds, " " disappears.
Example:

1/3 fr
└── French

Notes:

- In some cases, the subtitle language is not changed to the selected one.
- When a disc supporting closed caption is played, the subtitle and the closed caption may overlap each other on the TV screen. In this case, turn the subtitle off.
- When the desired language is not selected even if the button is pressed, the language is not available on the disc.
- When the power is turned on or the disc is replaced, select the subtitle language again.
- If the subtitle language is not necessary, press [ON/OFF-SUBTITLE] to select " Off".

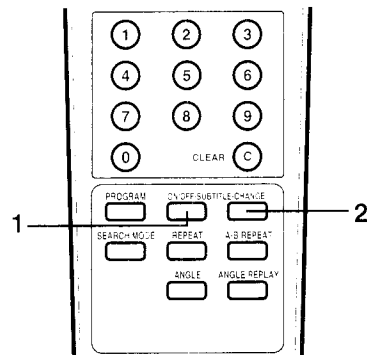

Selecting Audio Soundtrack Language (Multi-Language) [DVD]

This operation works only with discs on which multiple audio soundtrack languages are recorded.

1. Press [AUDIO] during playback.
2. Press [AUDIO] repeatedly until the desired language appears on the TV screen.
Examples:

1/4 fr
└── French

1/3 DTS
└── DTS sound

(If using an amplifier with DTS Decoder, the DTS sound will be heard. See page E10 for the amplifier connection.)

Notes:

- When the desired language is not selected even if the button is pressed, the language is not available on the disc.
- When the power is turned on or the disc is replaced, select the language again.
- If the language is not recorded on the disc, only the available language on the disc will be heard.

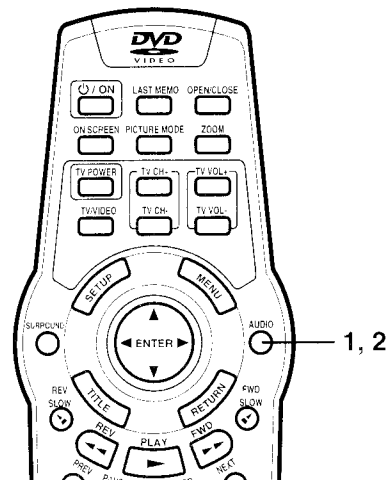
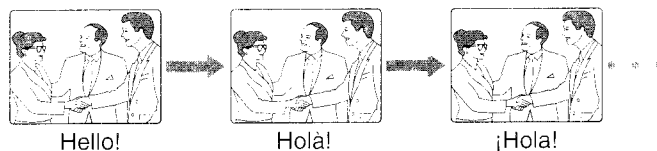

Need help? Call
1-800-421-5013

Selecting On-Screen Information

Press [ON SCREEN] repeatedly to show the disc information (Title, Chapter, Title elapsed playing time, Language, etc.).

Example for DVD:

1. Press [ON SCREEN] during playback.

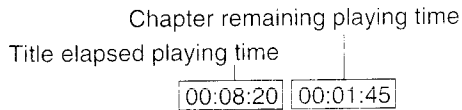

2. Press [ON SCREEN].

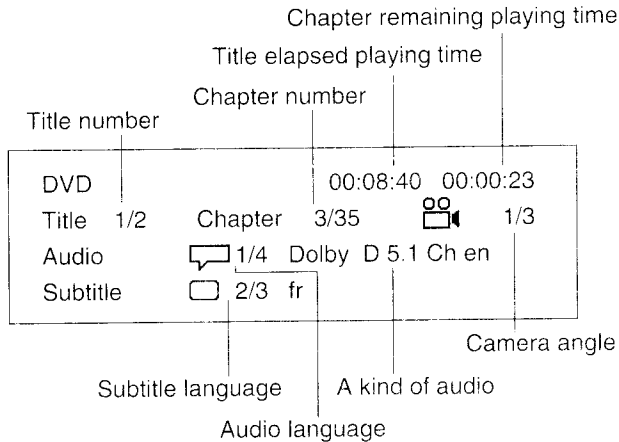

3. Press [ON SCREEN] to close the disc information.

Example for Music CD:

1. Press [ON SCREEN] during playback.

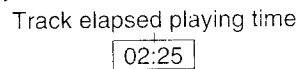

2. Press [ON SCREEN].

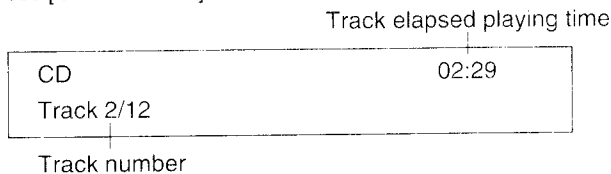

3. Press [ON SCREEN] to close the disc information.

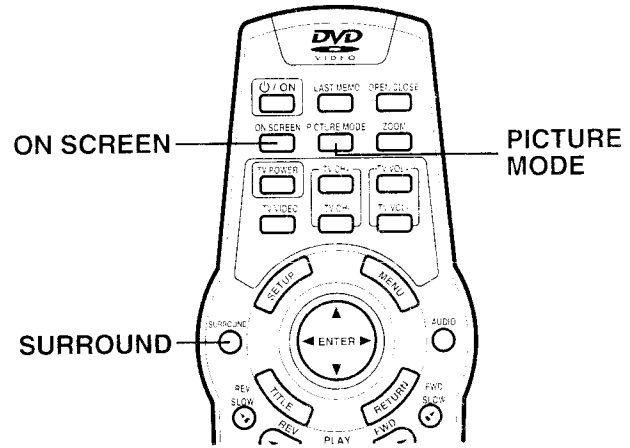

Selecting Picture Mode

Press [PICTURE MODE] to show the picture mode. Each time the button is pressed, the picture mode changes as below.

Standard Mild Black and White Standard ...

Selecting Spatializer N-2-2™ Virtual Surround Sound Mode [DVD] [CD]

Press [SURROUND] to set the Spatializer N-2-2 Virtual Surround Sound.

" On" briefly appears on the TV screen.
"SURR." appears on the FL display.

Press the button again to return to the original mode.
" Off" briefly appears on the TV screen.
"SURR." disappears.

Portions of this product are licensed from Desper Products, Inc., a subsidiary of Spatializer Audio Laboratories, Inc. Copyright ©1997-2001 Spatializer Audio Laboratories, Inc. All Rights Reserved Worldwide. *Spatializer*®, N-2-2™ and the circle-in-square device are trademarks of Desper Products, Inc.

For improvement, on-screen displays subject to change without notice.

Important Note:

" " may appear on the TV screen during operation. This icon means that the function is not available on the disc now.



**Need help? Call
1-800-421-5013**



MP3 CD OPERATION

This player can play back the CD-R/RW that have recorded music data or MP3 files. However, some CD-R/RWs can not be played back depending on the recording conditions. Before playing back MP3 CD, please read the following.

MP3 CD Information

Limitations on MP3 CD playback

- This player can recognize up to 256 files or folders per disc. The CD with 257 files or folders and over is not available to this player
- MP3 CD may not be played in the recorded order
- As for multi-session disc, only the first session can be played.
- If the CD has both audio tracks and MP3 files, only audio tracks are played.
- It would take 30 seconds or more for this player to read MP3 files depending on its structure.

Limitations on display

- Available letters for display are the following: capital or small alphabets of A through Z, and numbers of 0 through 9.
- Other letters than those above are replaced in "-" (hyphen).

Notes on MP3 files

- The recommend recording setting for a high-quality sound is 44.1 kHz of sampling frequency and 128kbps of fixing bit rate.
- To play back MP3 CD in the recorded order,
 - Please use the MP3 software with the function that can record data alphabetically or numerically.
 - Please refrain from making many sub-folders by preference.

CAUTION:

- Some MP3 CDs can not be played back depending on the recording conditions.
- The CD-R/RW that has no music data or non-MP3 files can not be played back.

MP3 CD Playback

- Press [OPEN/CLOSE] (or [▲]).
 - "OPEN" appears and the disc tray opens.

Note:
To open or close the disc tray, be sure to press [OPEN/CLOSE] (or [▲]). Do not press the disc tray with your hand.

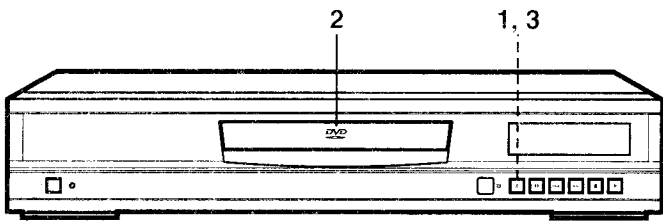

- Place the disc with the label facing up on the disc tray.

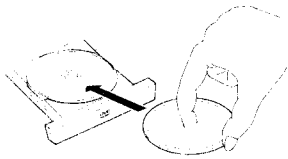

- Press [OPEN/CLOSE] (or [▲]).
 - The disc tray closes.
 - "READING" appears on the FL display
 - A table of contents in the first directory appears on the TV screen.

Example:

MP3	1/24	00:00:00
HYPER-EURO-MAX		
1 MUSIC001	8 MUSIC008	
2 MUSIC002	9 MUSIC009	
3 MUSIC003	10 MUSIC010	
4 MUSIC004	11 MUSIC011	
5 MUSIC005	12 MUSIC012	
6 MUSIC006		
7 MUSIC007		
File: MAX		

File information

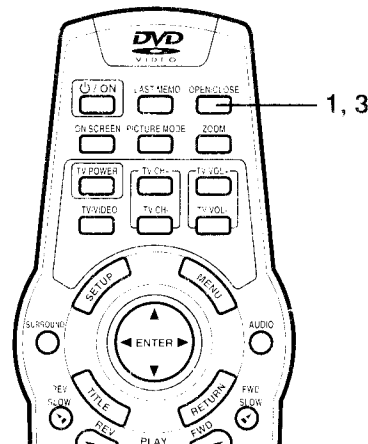

Note:

If the disc is loaded with the label side downward, or if a badly scratched disc is loaded, "NO DISC" (or "NO PLAY") appears. If this occurs, load the disc correctly or replace the disc.

4. Press the directional arrow button ([▲], [▶], [▼] or [◀]) to move the highlighted box to the desired file.
 - To go on to the next or previous directory, press the directional arrow button.
 - To go back to the previous directory, press [RETURN].
 - In some discs, if [MENU] is pressed, it goes back to the first directory.
5. Press [ENTER] to start playback.
 - "▶" briefly appears on the TV screen.
 - The letter's color in the highlighted box turns green.

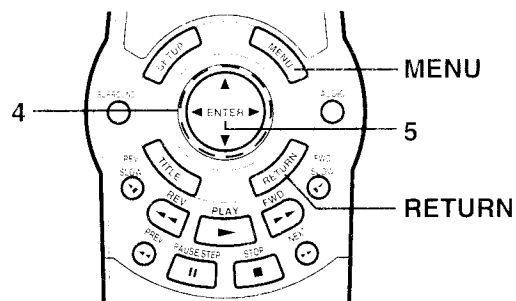

Example: (the second directory)

	Current file elapsed playing time	Total file number	Current file number
MP3	13/24	00:00:08	
MAX2			
13 MUSIC013	20 MUSIC020		
14 MUSIC014	21 MUSIC021		
15 MUSIC015	22 MUSIC022		
16 MUSIC016	23 MUSIC023		
17 MUSIC017	24 MUSIC024		
18 MUSIC018			
19 MUSIC019			
File: MAX			

Important Note:

"⊘" may appear on the TV screen during operation. This icon means that the function is not available on the disc now.



Need help? Call
1-800-421-5013

Stopping Playback

Press [STOP ■] during playback. "■" appears briefly on the TV screen and playback stops completely.

Pause

Press [PAUSE/STEP II] during playback.

- "II" appears briefly on the TV screen.
- "II" appears on the FL display.

Note:

The sound is muted.

Press [PLAY ▶] to return to normal playback.

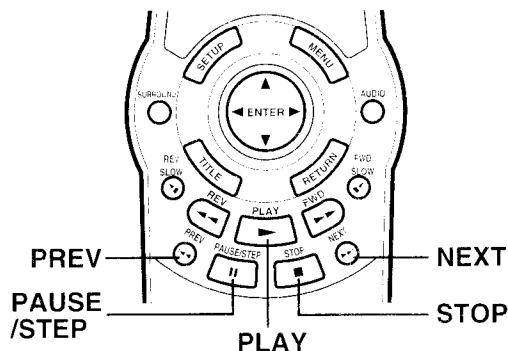

File Skip

Skipping forward

Press [NEXT ▶▶] during playback to skip to the next file.

"▶▶" appears briefly on the TV screen.

Skipping backward

Press [PREV ◀◀] during playback to skip back to the beginning of the file currently play.

"◀◀" appears briefly on the TV screen.

Press the button again immediately to skip back to the beginning of the previous file.

Repeat Playback

Press [REPEAT] during playback.

Each time the button is pressed, the repeat mode will be changed as follows.

- ↻ 1 (REP. 1):
Repeat of file being played
- ↻ All (REP. ALL):
Repeat all files
- ↻ Off:
Normal playback mode

Note:

Repeat playback may not work correctly with some discs.

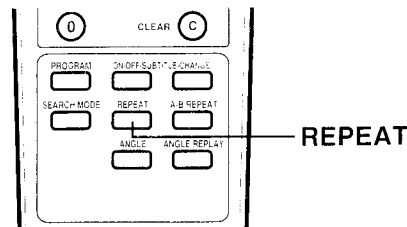

TVGuardian® OPERATION

Before Setting

- Initial setting is "CC2" on this unit.
- Please set "CC2" or "C2" (Closed caption on channel 2) on your TV first.
For more details, please refer to the instruction manual of your TV.
- Set the subtitle language to "Off". (See page E21.)

Setting TVGuardian®

Example:

To set "TV Mode Strict", "TVG CC On" and "TVG CC Ch CC2"

- Press [SETUP] in the stop mode.
The setup screen appears.
- Press [▶] to select "Parental".
- Press [ENTER].
"Parental" screen appears.
- Press [▼] to select "TVG Mode".
Note:
If the parental lock "🔒" is set, the highlighted box does not move. **You must enter the password to release the parental lock first.** See page E29.

Password	----	🔒
Level	Off	
TVG Mode	Off	Off
TVG CC	Off	Moderate
TVG CC Ch	CC2	Strict

Note:

If "TVG Mode" is not necessary, select "Off".

- Press [ENTER].
"TVG Mode Strict" remains.
- Press [▼] to select "TVG CC (Closed Caption)".
- Press [ENTER].
The submenu ("Off", "CUSS" and "On") appears.
- Press [▼] to select "On".

Password	----	🔒
Level	Off	
TVG Mode	Strict	
TVG CC	Off	Off
TVG CC Ch	CC2	CUSS
		On

Note:

If "TVG CC Off" is selected, closed caption may not appear at CC2 mode on your TV screen.

In this instruction manual, the language in on-screen display is English. If you change the language (see page E27), please follow the selected language in on-screen display.

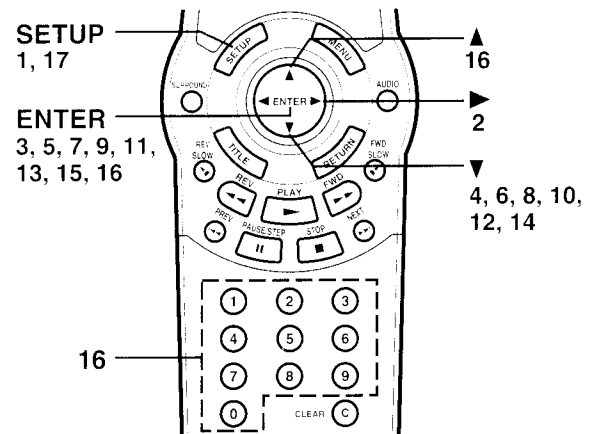

- Press [ENTER].
"TVG CC On" remains.
- Press [▼] to select "TVG CC Ch (Output Channel)".
- Press [ENTER].
The submenu ("CC1" and "CC2") appears.
- Press [▼] to select "CC2".

Password	----	🔒
Level	Off	
TVG Mode	Strict	
TVG CC	On	
TVG CC Ch	CC2	CC1
		CC2

Note:

This is channel number setting for your TV. For more details, please refer to the instruction manual of your TV.

- Press [ENTER].
"TVG CC Ch CC2" remains.
- After step 15, you must set the parental lock as shown below.**
(For more details, please refer to "Setting Parental" on page E29.)
 - Press [▲] to select "Level".
 - Press [ENTER] repeatedly to select the parental lock level.
 - Press [▲] to select "Password ----".
 - Enter a number in 4 digits.
 - Press [ENTER].
"🔒" appears.

Note:

If you do not set it, the TVGuardian does not work, and it returns to the initial settings.

- Press [SETUP].
The setup screen disappears.

How It Works After Setting TVGuardian®:

When a disc supporting closed caption is played, it mutes the entire phrase instead of just the swear word and displays the modified text, by design. It turns the sound back on when the phrase is completed.

Examples:

The phrase "Get the hell out.", is muted and "Get Out.", is displayed.

The phrase "Move you're a--!", is muted and "Move your tail!", is displayed.

IMPORTANT INFORMATION:

- Use a TV with closed caption capability and set the function to "On".
- Set the same channel number on your TV as above.
- The built-in TVGuardian® Foul Language Filter (TVG®) works only English language DVD video disc supporting closed caption, not any other languages.
- **For improvement, on-screen displays subject to change without notice.**

Setting TVGuardian			Operation (TV: CC2 or C2)	
TVG Mode	TVG CC	TVG CC Ch	Sound	Closed Caption
Off	--	CC2	Original sound	No display
Moderate	Off	CC2	Mute the swear word	No display
	CUSS	CC2	Mute the swear word	Display the modified text only
	On	CC2	Mute the swear word	Display all text with the modified text
Strict	Off	CC2	Mute the swear word	No display
	CUSS	CC2	Mute the swear word	Display the modified text only
	On	CC2	Mute the swear word	Display all text with the modified text

Setting TVGuardian			Operation (TV: CC1 or C1)	
TVG Mode	TVG CC	TVG CC Ch	Sound	Closed Caption
Off	--	CC2	Original sound	Original text
Moderate	Off	CC2	Mute the swear word	No display
	CUSS	CC2	Mute the swear word	No display
	On	CC2	Mute the swear word	No display
Strict	Off	CC2	Mute the swear word	No display
	CUSS	CC2	Mute the swear word	No display
	On	CC2	Mute the swear word	No display

Notes:

- Foul word that are normally filtered are missed when closed-captioning errors exist (i.e. a foul word is not captioned, misspelled or is not synchronized with the spoken word.)
- The built-in Foul Language Filter may not work on some discs depending on recording conditions.
- DVD video discs may or may not respond to the TVG Mode settings. Make sure this function works with your DVD video discs.
- When playback starts, the TVG information may appear on the TV screen.

TVGuardian® and TVG® are registered trademarks of Principle Solutions, Inc.



**Need help? Call
1-800-421-5013**

INITIAL SETTINGS

Once the initial settings have been completed, the player can always be operated under the same conditions. The settings will be retained in the memory until they are changed, even if the power is turned off.

Setting Language

1. Press [SETUP] in the stop mode.
The setup screen appears.
"Language" is highlighted.
2. Press [ENTER].
"Language" screen appears.
3. Press [▼] or [▲] to select the item (highlighted).

Example:

OSD	English
Audio	Disc
Subtitle	Disc
DVD Menu	Disc

4. Press [ENTER].
The submenu appears.
Example:

OSD	English	English
Audio	Disc	Español
Subtitle	Disc	Français
DVD Menu	Disc	Deutsch
		Portugues

5. Press [▼] or [▲] to select the language (highlighted).
6. Press [ENTER].
The selected language remains.
7. Repeat steps 3 and 6 for other items.
Note:
If "Others" is selected, enter the language code. (See "LANGUAGE CODE LIST" on page E30.)
8. Press [▲] to skip back to the setup screen (or press [SETUP]).

Notes:

- In this instruction manual, the language in on-screen display is English.
If you change the language, please follow the selected language in on-screen display.
- You cannot switch audio sound track languages if there is only one language recorded on the disc.
- When you play back a DVD video disc, the player automatically displays the pre-selected subtitle language if it is included on the disc.
- If "Others" is selected, enter the language code. (See "LANGUAGE CODE LIST" on page E30.)
- **For improvement, on-screen displays subject to change without notice.**

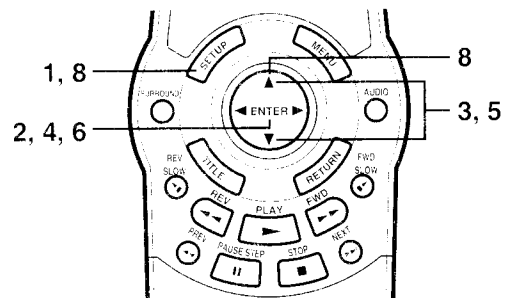

**Need help? Call
1-800-421-5013**

Setting Parental

Note:

If you set "TVG Mode", "TVG CC" or "TVG CC Ch", set them first before steps 6 and 7. See "Setting TVGuardian®" on page E25.

1. Press [SETUP] in the stop mode.
The setup screen appears.
2. Press [▶] to select "Parental".
3. Press [ENTER].
"Parental" screen appears.
4. Press [▼] to skip "Password ----" and select "Level".

Password	----	
Level	Off	
TVG Mode	Off	
TVG CC	Off	
TVG CC Ch	CC2	

5. Press [ENTER] repeatedly to select the parental lock level ("Level Off" ~ "Level 8").
6. Press [▲] to return to "Password ----".
7. Enter a number in 4 digits, then press [ENTER].
The password is now set.

Password	----	
Level	1	
TVG Mode	Off	
TVG CC	Off	
TVG CC Ch	CC2	

Note:

If you do not set it, Parental Control does not work, and it returns to the initial settings.

8. Press [SETUP].
The setup screen disappears.

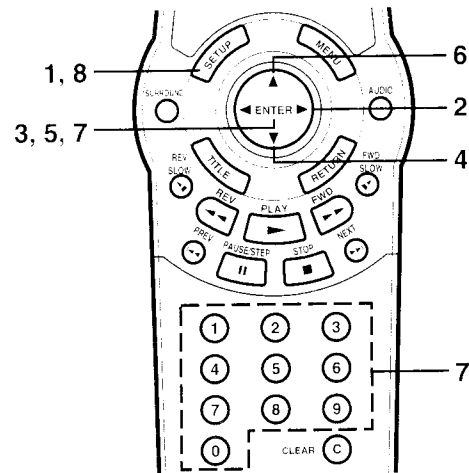

Parental Control

MPAA (Motion Picture Association of America) Guideline is a rating system that provides advanced cautionary information to parent about the content of movie programs.

The parental lock level is equivalent to the following MPAA Rating System.

- Level 7: NC-17 (No one 17 and under admitted)
- Level 6: R (Restricted)
- Level 4: PG13 (Parental guidance cautioned)
- Level 3: PG (Parental guidance suggested)
- Level 1: G (General audiences)

Some DVD discs contain a restriction level which enables parents to prevent playback of discs by children. This DVD video player is equipped with a password designed to prevent children changing the level.

You cannot play DVD video discs rated higher than the level you selected unless you cancel the parental lock function. For example, when you select level "5", the DVD video player will not play discs with ratings of "6", "7" or "8". The information will appear on the TV screen.

If you forget the password...

Enter "788444" even if 4 digits "----" appears, then press [ENTER] to clear the current password. Enter a new password and set the parental lock level again.

Note:

DVD video discs may or may not respond to the parental lock settings. Make sure this function works with your DVD video discs.

To lock the disc tray

You can lock the disc tray to prevent misuse of young children. While the disc tray is opened, press the ▲ button on the DVD video player until "LOCK" appears on the FL display (or "Disc Tray Locked" appears on the TV screen). (The disc tray closes.)

- The ▲ button (or [OPEN/CLOSE]) will not function.

To release this mode, press the ▲ button until "UNLOCK" appears on the FL display (or "Disc Tray Unlocked" appears on the TV screen).



**Need help? Call
1-800-421-5013**

LANGUAGE CODE LIST

Enter the appropriate code number for the initial settings "AUDIO", "SUBTITLE" and "DVD MENU".

Code	Abbreviation of the language	Language	Code	Abbreviation of the language	Language	Code	Abbreviation of the language	Language
6565	aa	Afar	7369	ie	Interlingue	8278	rn	Kirundi
6566	ab	Abkhazian	7375	ik	Inupiak	8279	ro	Romanian
6570	af	Afrikaans	7378	in	Indonesian	8285	ru	Russian
6577	am	Amharic	7383	is	Icelandic	8287	rw	Kinyarwanda
6582	ar	Arabic	7384	it	Italian	8365	sa	Sanskrit
6583	as	Assamese	7387	iw	Hebrew	8368	sd	Sindhi
6589	ay	Aymara	7465	ja	Japanese	8371	sg	Sangro
6590	az	Azerbaijani	7473	ji	Yiddish	8372	sh	Serbo-Croatian
6665	ba	Bashkir	7487	jw	Javanese	8373	si	Singhalese
6669	be	Byelorussian	7565	ka	Georgian	8375	sk	Slovak
6671	bg	Bulgarian	7575	kk	Kazakh	8376	sl	Slovenian
6672	bh	Bihari	7576	kl	Greenlandic	8377	sm	Samoan
6673	bi	Bislama	7577	km	Cambodian	8378	sn	Shona
6678	bn	Bengali; Bangla	7578	kn	Kannada	8379	so	Somali
6679	bo	Tibetan	7579	ko	Korean	8381	sq	Albanian
6682	br	Breton	7583	ks	Kashmiri	8382	sr	Serbian
6765	ca	Catalan	7585	ku	Kurdish	8383	ss	Siswati
6779	co	Corsican	7589	ky	Kirghiz	8384	st	Sesotho
6783	cs	Czech	7665	la	Latin	8385	su	Sundanese
6789	cy	Welsh	7678	ln	Lingala	8386	sv	Swedish
6865	da	Danish	7679	lo	Laothian	8387	sw	Swahili
6869	de	German	7684	lt	Lithuanian	8465	ta	Tamil
6890	dz	Bhutani	7686	lv	Latvian, Lettish	8469	te	Telugu
6976	el	Greek	7771	mg	Malagasy	8471	tg	Tajik
6978	en	English	7773	mi	Maori	8472	th	Thai
6979	eo	Esperanto	7775	mk	Macedonian	8473	ti	Tigrinya
6983	es	Spanish	7776	ml	Malayalam	8475	tk	Turkmen
6984	et	Estonian	7778	mn	Mongolian	8476	tl	Tagalog
6985	eu	Basque	7779	mo	Moldavian	8478	tn	Setswana
7065	fa	Persian	7782	mr	Marathi	8479	to	Tonga
7073	fi	Finnish	7783	ms	Malay	8482	tr	Turkish
7074	fj	Fiji	7784	mt	Maltese	8483	ts	Tsonga
7079	fo	Faeroese	7789	my	Burmese	8484	tt	Tatar
7082	fr	French	7865	na	Nauru	8487	tw	Twi
7089	fy	Frisian	7869	ne	Nepali	8575	uk	Ukrainian
7165	ga	Irish	7876	nl	Dutch	8582	ur	Urdu
7168	gd	Scots Gaelic	7879	no	Norwegian	8590	uz	Uzbek
7176	gl	Galician	7967	oc	Occitan	8673	vi	Vietnamese
7178	gn	Guarani	7977	om	(Afan) Oromo	8679	vo	Volapük
7185	gu	Gujarati	7982	or	Oriya	8779	wo	Wolof
7265	ha	Hausa	8065	pa	Punjabi	8872	xh	Xhosa
7273	hi	Hindi	8076	pl	Polish	8979	yo	Yoruba
7282	hr	Croatian	8083	ps	Pashto, Pushto	9072	zh	Chinese
7285	hu	Hungarian	8084	pt	Portuguese	9085	zu	Zulu
7289	hy	Armenian	8185	qu	Quechua			
7365	ia	Interlingua	8277	rm	Rhaeto-Romance			



TROUBLESHOOTING GUIDE

If you have followed the instructions and are having difficulty operation the unit, locate the SYMPTOM in the left column below. Check the corresponding POSSIBLE CAUSE and CORRECTIVE ACTION columns to locate and remedy the problem.

SYMPTOM	POSSIBLE CAUSE	CORRECTIVE ACTION
No power.	No power plug connection at the AC wall outlet.	Insert the power plug into the AC wall outlet.
The power is on, but the player does not work.	No disc is loaded.	Load a disc.
No picture.	An unplayable disc is loaded.	Load a playable disc. (Check the disc logo, type, color system and regional code.)
	The TV is not set to receive signal from the player.	Select the correct input function on the TV.
	The video cable is not connected.	Connect the video cable into the jack.
	The S-video cable is not connected.	Connect the video cable into the jack.
No sound.	The TV is turned off.	Turn on the TV.
	The audio cables are not connected.	Connect the audio cables into the jacks.
	The audio equipment is turned off.	Turn on the audio equipment connected with the audio cable.
The playback picture is poor.	An unplayable disc is loaded.	Load a playable disc. (Check the disc logo, type, color system and regional code.)
"⊗" appears on the TV screen.	The selected function does not operate on the disc now.	The feature or action cannot be completed at this time because: <ul style="list-style-type: none"> • The feature is not available at the moment. • The DVD software restricts it. • The DVD software doesn't support the feature (e.g., angles).
The player does not start playback.	No disc is loaded.	Load a disc.
	An unplayable disc is loaded.	Load a playable disc. (Check the disc logo, type, color system and regional code.)
	The disc is loaded with the label side down.	Load the disc on the disc tray correctly.
	The disc is dirty.	Clean the disc or replace it.
	"Parental" is set.	Cancel the parental lock function or change the rating level. Reset it after play. (See page E29.)
The disc tray does not open.	The disc tray may be locked.	Press the ▲ button on the DVD video player until "UNLOCK" appears. (See page E29.)
The operation or display is not normal.	The player must be reset.	<ol style="list-style-type: none"> 1. Disconnect the power cord. 2. Reconnect the power cord. 3. Resume operation.
The remote control does not work properly.	The batteries in the remote control are weak, or installed incorrectly.	Check the battery polarity (+ or -). Replace the batteries.
	The remote control is not aimed at the remote sensor window.	Aim the remote control at the remote sensor window.

SERVICING:

Should this product require service, refer to the FISHER DVD limited warranty.

If you do not have a convenient FISHER service station nearby, contact the FISHER dealer where you purchased the unit. Be sure to give the model number and explain the problem. The dealer will advise you how to obtain service.

MAINTENANCE

WARNING:

FOR YOUR PERSONAL SAFETY, BE SURE TO DISCONNECT THE AC POWER CORD BEFORE PROCEEDING WITH ANY MAINTENANCE OR CLEANING.

Cleaning the cabinet

Use a clean soft cloth moistened with plain lukewarm water and wrung dry. Never use benzol, benzene or other strong chemical cleaners since these could damage the finish of your unit. It is important that no liquid reaches the inside of the unit.

SPECIFICATIONS

Type:

DVD Video player

Signal format:

NTSC color

Laser:

Semiconductor laser, wavelength 650 nm/790 nm

Frequency range (digital audio):

4 Hz to 44 kHz (DVD fs: 96 kHz)

Signal to noise ratio:

More than 105 dB

Harmonic distortion (digital audio):

0.003 %

Wow and flutter:

Below measurable level

Outputs:

DIGITAL OUT:

Optical

COMPONENT VIDEO OUT:

Y: 1.0 V_{p-p} (75 Ω)

C_B, C_R: 0.7 V_{p-p} (75 Ω)

AUDIO OUT:

L: 2 V rms

R: 2 V rms

VIDEO OUT:

1.0 V_{p-p} (75 Ω)

S-VIDEO OUT:

Y: 1.0 V_{p-p} (75 Ω)

C: 0.286 V_{p-p} (75 Ω)

Power requirements:

AC 120 V, 60 Hz

Power consumption:

12 Watts

Dimensions (W x H x D):

Approx. 17.1" x 3.1" x 11" (435 x 79 x 281 mm)

Weight:

Approx. 6.2 lbs (2.8 kg)

IMPORTANT INFORMATION

Because its products are subject to continuous improvement, FISHER reserves the right to modify product designs and specifications without notice and without incurring any obligation.



**FISHER DVD
MODEL DVD-SL30 LIMITED WARRANTY**

OBLIGATIONS

In order to obtain warranty service, the product must be delivered to and picked up from an Authorized Fisher Factory Service Center at the user's expense, unless specifically stated otherwise in this warranty. The names and addresses of Authorized Fisher Service Centers may be obtained by calling the toll-free number listed below.

For product operation, authorized service center referral, service assistance or problem resolution, call

**CUSTOMER INFORMATION 1-800-421-5013
Weekdays 8:00 AM - 5:00 PM Pacific Time**

For accessories and/or parts not available from an authorized dealer, call

**PARTS ORDER INFORMATION 1-800-726-9662
Weekdays 8:00 AM - 5:00 PM Pacific Time**

THIS WARRANTY IS VALID ONLY ON FISHER PRODUCTS PURCHASED OR RENTED AND USED IN THE UNITED STATES OF AMERICA. THIS WARRANTY APPLIES ONLY TO THE ORIGINAL RETAIL USER, AND DOES NOT APPLY TO PRODUCTS USED FOR ANY INDUSTRIAL, PROFESSIONAL OR COMMERCIAL PURPOSE. THE ORIGINAL DATED BILL OF SALE, SALES SLIP OR RENTAL AGREEMENT MUST BE SUBMITTED TO THE AUTHORIZED FISHER SERVICE CENTER AT THE TIME WARRANTY SERVICE IS REQUESTED.

Subject to the OBLIGATIONS above and EXCLUSIONS below, SANYO FISHER COMPANY (SFC) warrants this FISHER product against defects in materials and workmanship for the periods of LABOR and PARTS specified below. SFC will repair or replace (at its option) the product and any of its parts which fail to conform to this warranty. The warranty period commences on the date the product was first purchased or rented at retail.

LABOR	PARTS
1 YEAR	1 YEAR

EXCLUSIONS

This warranty does not cover (A) the adjustment of customer-operated controls as explained in the appropriate model's instruction manual, or (B) the repair of any product whose serial number has been altered, defaced or removed.

This warranty shall not apply to the cabinet or cosmetic parts, knobs or routine maintenance.

This warranty does not apply to uncrating, setup, installation, removal of the product for repair or reinstallation of the product after repair.

This warranty does not apply to repairs or replacements necessitated by any cause beyond the control of SFC including, but not limited to, any malfunction, defect or failure caused by or resulting from unauthorized service or parts, improper maintenance, operation contrary to furnished instructions, shipping or transit accidents, modification or repair by the user, abuse, misuse, neglect, accident, incorrect power line voltage, fire, flood or other Acts of God, or normal wear and tear. The foregoing is in lieu of all other expressed warranties and SFC does not assume or authorize any party to assume for it any other obligation or liability.

THE DURATION OF ANY WARRANTIES WHICH MAY BE IMPLIED BY LAW (INCLUDING THE WARRANTIES OF MERCHANTABILITY AND FITNESS) IS LIMITED TO THE TERM OF THIS WARRANTY. IN NO EVENT SHALL SFC BE LIABLE FOR SPECIAL, INCIDENTAL OR CONSEQUENTIAL DAMAGES ARISING FROM OWNERSHIP OR USE OF THIS PRODUCT, OR FOR ANY DELAY IN THE PERFORMANCE OF ITS OBLIGATIONS UNDER THIS WARRANTY DUE TO CAUSES BEYOND ITS CONTROL.

SOME STATES DO NOT ALLOW LIMITATIONS ON HOW LONG AN IMPLIED WARRANTY LASTS AND/OR DO NOT ALLOW THE EXCLUSION OR LIMITATION OF CONSEQUENTIAL DAMAGES, SO THE ABOVE LIMITATIONS AND EXCLUSIONS MAY NOT APPLY TO YOU.

THIS WARRANTY GIVES YOU SPECIFIC LEGAL RIGHTS. YOU MAY HAVE OTHER RIGHTS, WHICH VARY FROM STATE TO STATE.

F/A R11 (M)

For your protection in the event of theft or loss of this product, please fill in the information below for your own personal records.

Model No. _____

Serial No. _____
(Located on back or bottom side of unit)

Date of Purchase _____

Purchase Price _____

Where Purchased _____



21605 Plummer Street
Chatsworth, CA 91311

Downloaded from www.Somanu.com All Manuals Search And Download.

Printed in China

Free Manuals Download Website

<http://myh66.com>

<http://usermanuals.us>

<http://www.somanuals.com>

<http://www.4manuals.cc>

<http://www.manual-lib.com>

<http://www.404manual.com>

<http://www.luxmanual.com>

<http://aubethermostatmanual.com>

Golf course search by state

<http://golfingnear.com>

Email search by domain

<http://emailbydomain.com>

Auto manuals search

<http://auto.somanuals.com>

TV manuals search

<http://tv.somanuals.com>