

Installation instructions and user guide

Front loading dryers

ED56, AD55, AD39 models

NZ AU GB IE

Introduction	2
Safety and warnings	3
Installation instructions	
Installation options	5
Installation – Electronic and Manual 4.5 kg dryers	6
Installation – Manual 3.5 kg dryers	8
Specifications	8
Dryer wall mounting instructions	9
Before you dry	
Sorting and loading	11
Cleaning the lint filter	12
Electronic dryer	
Using your dryer	13
Dryness levels	13
1 hour settings	14
Key Lock	14
Temperature settings	15
Delay start	15
Wrinkle guard	15
Manual dryers	
Using your dryer	16
Drying times	17
Drying rack	18
Operating problems	19
Manufacturers warranty	20
Customer care	21

Important!

SAVE THESE INSTRUCTIONS

The models shown in this user guide may not be available in all markets and are subject to change at any time. For current details about model and specification availability in your country, please go to our website www.fisherpaykel.com or contact your local Fisher & Paykel dealer.

Download from www.Somanuals.com. All Manuals Search And Download.

Congratulations on purchasing a Fisher & Paykel dryer. Your new dryer will give you the convenience of tumble drying and your clothes the advantage of not being subjected to the harsh overdrying effects of the sun. Your clothes will feel softer, retain their shape better and will require less ironing.

At Fisher & Paykel we aim to provide products that are simple to use, ergonomic and energy efficient. Thousands of tonnes of washing and 70 years of laundry experience have been programmed into your dryer to help give you the best possible performance.

We hope you enjoy your new dryer. We have certainly enjoyed designing it.

Cost to dry

Many people are reluctant to use a dryer because they believe they are expensive to run. True enough, sunshine is free, but we don't always have sunshine and the benefits to you and your clothes can make machine drying worthwhile.

The following example of a 2.5 kg load is used to demonstrate the cost of drying.

- 4 T-shirts
- 1 Sweat Shirt
- 5 Pair Underpants
- 5 Pairs Socks
- 1 Pair Trousers
- 2 Pair Shorts
- 3 Handkerchiefs

This load was spun at a high spin speed (1000 rpm) and dried in an Electronic dryer on dryness level 4 (Medium dry and Extra dry lights on). The load took 60 minutes to dry.

For example if power costs 10 cents / unit, the load will cost approximately 15 cents to dry (1.48 units x 10c). Check with your local Electricity Supply Authority for your domestic tariff.

Before using your dryer

- Ensure the correct installation has been used for the dryer type. The Electronic and Manual 4.5 kg dryers are rear venting dryers while the Manual 3.5 kg dryer is a front venting dryer.
- Read the Safety and Installation Instructions.

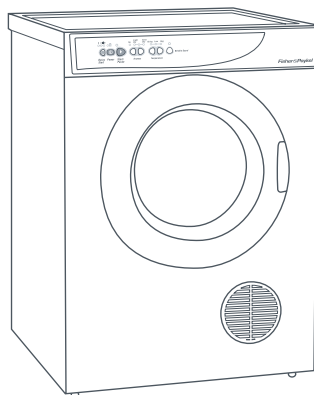

⚠ WARNING!**Fire Hazard**

Only dry fabrics that have been washed with water.

Do not use heat to dry articles containing foam rubber or similarly textured rubber-like materials. Dry on Airing.

A clothes dryer produces combustible lint and must be exhausted outdoors.

Take care to prevent the accumulation of lint around the exhaust opening and surrounding area.

Failure to follow these instructions can result in death or personal injury.

Dryer use

- The tumble dryer is intended only for drying textile material washed in water.
- Undergarments that contain metal reinforcements should not be placed in the dryer. Damage to the dryer can result if the metal reinforcements come loose during drying. If you wish to dry these items use a drying rack.
- Never dry rubber articles, fibreglass, or any plastic items or film eg plastic lined tablecloths and baby bibs.
- Clothes should go through the cool down/airing phase of the cycle. If for any reason the dryer is stopped before the cycle has finished, dry clothes should be removed immediately and not left in the dryer.
Clothes should be spread out to cool and not left bunched up eg in a clothes basket.
- This dryer has been designed for domestic use only, not for commercial applications, such as massage/beauty clinics where there may be increased lint accumulation or flammable materials in the atmosphere or load.
- This dryer is not intended for use by young children or infirm persons without supervision.
- Young children should be supervised to ensure they do not play with the dryer.

Important!

If you are using an extension cord or a portable electrical outlet device (eg multi-socket outlet box), ensure that it is positioned so that it does not come into contact with water or moisture.

Lint

Accumulated lint in the dryer can become a fire hazard, it also reduces the efficiency of the dryer by causing longer drying times and increased power consumption.

- Clean the lint filter before every load.
- Ensure the area around the dryer is clear of lint.
- At regular intervals have the interior of the dryer cleaned of any accumulated lint. This must be done by a qualified person for electrical safety.
- If you change the mounting of the dryer from upright to inverted or vice versa, the dryer must be cleaned internally by a serviceman.

4 Safety and warnings

Spontaneous combustion

Important!

To reduce the risk of fire in a tumble dryer the following should be observed:

- Items that have been spotted or soaked with vegetable oil or cooking oil are a fire hazard and should not be placed in a tumble dryer.
- Oil-affected items can ignite spontaneously, especially when exposed to heat sources such as a tumble dryer.
The items become warm causing an oxidation reaction in the oil. This oxidation creates heat. If the heat cannot escape the items can become hot enough to catch fire. Piling, stacking or storing oil-affected items can prevent heat from escaping creating a fire hazard.
- If it is unavoidable that fabrics that contain vegetable oil, cooking oil or have been contaminated by hair care products be placed in a tumble dryer, they should first be washed in hot water with extra detergent – this will reduce, but not eliminate the fire hazard. The cool down cycle of the dryer should be used to reduce the temperature of these items. They should not be removed from the tumble dryer or piled or stacked while hot.
- Items that have previously been cleaned in, washed in, soaked in or spotted with flammable liquids or solids eg petrol/gasoline, kerosene, dry cleaning solvents, vegetable or cooking oil, waxes or other flammable or explosive substances should not be placed in a tumble dryer.
- Highly flammable substances commonly used in domestic environments include acetone, denatured alcohol, petrol/gasoline, kerosene, some brands of spot removers, turpentine, waxes and wax removers.
- Fabric Softeners or similar products should not be used in a tumble dryer to eliminate the effects of static electricity, unless this practice is specifically recommended by the manufacturer of the fabric softener product.
- Rubber backed articles, clothes fitted with foam rubber pads, pillows, fibreglass, shoes containing rubber, plastic items such as shower caps, and babies waterproof napkin covers should not be placed in the dryer.
- Items containing rubber (also known as latex foam) or similarly textured rubber like materials should not be dried on any heat setting. Dry these garments on Airing. Foam rubber material can when heated produce fire by spontaneous combustion.

There are several different ways you can install your dryer.

1. Free standing

The dryer stands on the floor and can easily be moved into position.

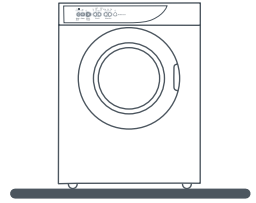

Fig. 1 Free standing

2. Plinth*

Electronic and Manual 4.5 kg only

A plinth, with adjustable feet, allows the dryer to be:

- matched in height to your washer.
- installed under a bench.

Plinths can be purchased from your dealer.

115 mm Plinth Part No. 94832

60 mm Plinth Part No. 94852

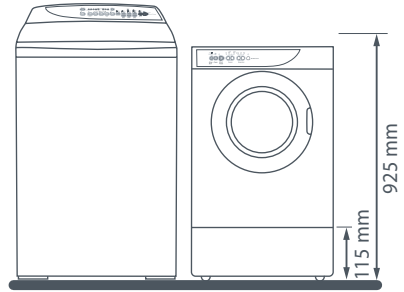

Fig. 2 Plinth height

3. Upright wall mounting*

All models

The wall mounting kit allows the dryer to be installed at any desired height minimising the amount of bending and stretching.

Wall Mounting Kit Part No. 502067

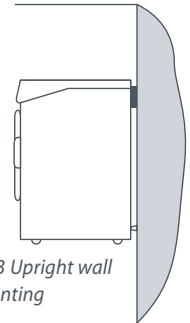

Fig. 3 Upright wall mounting

4. Inverted wall mounting*

All models

A wall mounting kit and inverted panel allows you to install the dryer above the washer or tub.

AD39 Inverted Panel Part No. 427560P

AD55 Inverted Panel Part No. 427560

ED56 Inverted Panel Part No. 427562

Wall Mounting Kit Part No. 502067

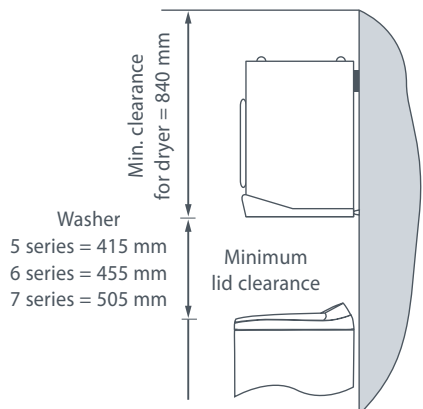

Fig. 4 Inverted wall mounting

*Contact your dealer for assistance with plinths, inversion kits and wall mounting kits

Correct installation is very important for all dryers to ensure maximum efficiency and safety.

Important!

Never run the dryer unless the airflow system is free from obstruction.

There must be adequate ventilation to avoid the backflow of gases into the room from appliances burning fuels, including open fires, when operating the dryer.

Exhaust air must not be discharged into a flue which is used for exhausting fumes from appliances burning gas or other fuels.

External venting

The dryer has been designed to be externally vented to provide the following advantages:

- Ensures optimum efficiency by preventing recirculation of moist air.
- Eliminates condensation on walls and ceilings.
- Reduces the chance of lint being sucked into the dryer.
- Prevents lint and other fine particles being blown into the room.

All external venting systems should be:

- Made from galvanised metal pipe or be sleeved with a galvanised metal pipe where the vent system goes through a wall or ceiling.
- Exhausted outside and not into another confined space.
- Fitted with a vent cap outside to stop rain water entering the dryer exhaust system.
- Angled to avoid condensation running back into the dryer.
- Less than 2 m long. Special installation is required for ducting over 2 m. Contact your Authorised Service Centre.

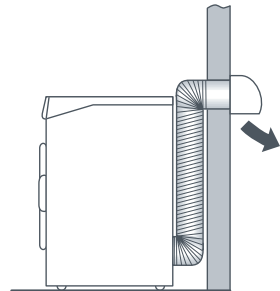

Fig. 5 External venting

DO NOT use the internal vent deflector as an external weather cap as this will cause restriction of the airflow and a loss in performance.

Flush venting

The dryer is vented through a hole in the wall, using a galvanised metal pipe or flexible hose. This is suitable for floor and wall mounted dryers installed against an outside wall.

Flexible Hose 400 mm Part No. 460754

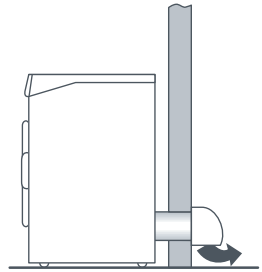

Fig. 6 Flush venting

Movable venting

The dryer is vented using a flexible hose through a hole in the wall. This allows the dryer to be moved from the wall slightly. Suitable for floor mounted dryers only.

Flexible Hose 2 m Part No. 503858

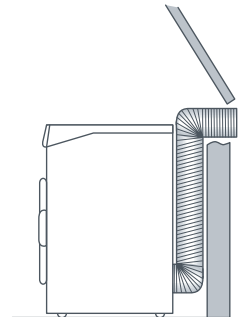

Fig. 7 Movable venting

Window venting

A flexible hose is used to vent the dryer through a window. Maximum hose length is 2 metres.

Flexible Hose 2 m Part No. 503858

Venting duct

The dryer is vented using an extendible duct that allows venting to a window or through an existing wall vent. The duct can be used with a flexible hose. Specially suitable for inverted dryers.

Venting Duct Kit Part No. 460886

Flexible Hose 2 m Part No. 503858

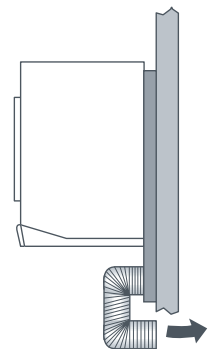

Fig. 8 Venting duct

Internal venting

Included with the dryer is a vent deflector. This screws on to the back of the dryer over the exhaust outlet. If external venting is not possible the deflector must be fitted. The outlet of the vent deflector must be clear of any obstructions to ensure normal and safe operation.

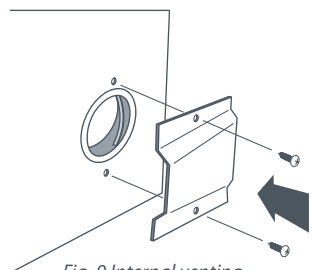

Fig. 9 Internal venting

Dryer position

The Manual 3.5 kg dryer is front venting. The air is taken in through the grill at the rear of the dryer and vented out through the grill in the door.

The dryer should be positioned so that the air intake at the rear is unrestricted. The minimum clearance needed from the wall is 50 mm.

Included with this dryer are two plastic spacers. Fitting these on the rear of the dryer will ensure the dryer is correctly positioned away from the wall.

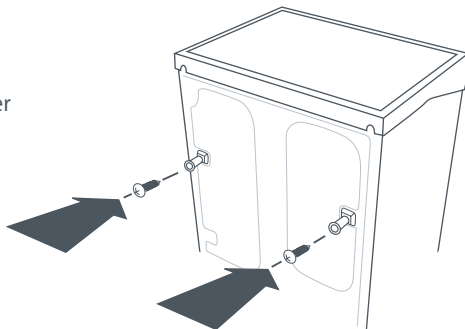

Fig. 10 Spacers

- Use screws provided to fit the spacers. (As shown in the diagram.)

Directional outlet grill

The outlet grill can be rotated to direct the exhaust air. It should be adjusted so that it points towards an external window or door.

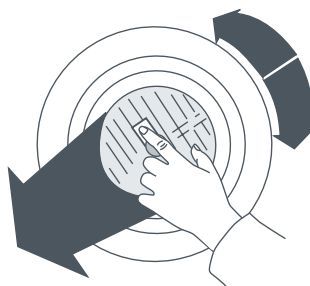

Fig. 11 Directional outlet grill

Specifications

	Electronic and Manual dryers	Manual dryers
Capacity (Dry)	4.5 kg (Dry)	3.5 kg (Dry)
Dimensions		
Width	565 mm	565 mm
Depth	560 mm	440 mm
Height	790 mm	790 mm
Electrical	NZ/AUS	NZ/AUS
Volts	230/240	230/240
Hz	50	50
Amps	8.0	8.0

Note: if the electrical supply cord is damaged it must be replaced by the manufacturer or its service agent or similar qualified person in order to avoid a hazard.

Tools and parts required:

- 1 drill and 3 mm bit
- 1 Phillips screw driver
- 2 wood screws 14 x 50 timbertite screws
- 1 screw driver
- 1 helper to lift dryer onto bracket

Extra tools and parts for mounting onto a concrete wall:

- 1 6 mm bit
- 2 M6 x 50 expanding bolts
- 1 adjustable spanner

Note: read these instructions in conjunction with venting instructions.

- 1 Determine the position of the dryer on the wall and mark the bracket position.
 - A minimum of 70 mm is needed between the top of the bracket and the ceiling for ease of installation.
 - If mounting over a washer allow sufficient room to open the lid of the washer or use a lid catch retainer – Part no. 479273.
 - If the dryer is vented through the mounting wall ensure the venting hole clears any studs.
- 2 Fit the bracket to the wall. Ensure the bracket is securely fastened at both ends (eg into the stud). Fit a timber slat between the studs to mount the bracket onto if the stud position is too wide.
- 3 Fit the spacers using screws provided. If timber slat has been used with wall mounting bracket, pack spacers away from wall by same amount.
- 4 Mount the dryer on the bracket. Tilt the dryer out from below, engage the bracket in the back panel slots then lower the dryer and rest against the wall.

WARNING!



Weight Hazard

**Use two or more people to move and install the dryer.
Failure to do so can result in back or other injury.**

- 5 Fit inverted control panel over the existing panel if necessary.

10 Dryer wall mounting instructions

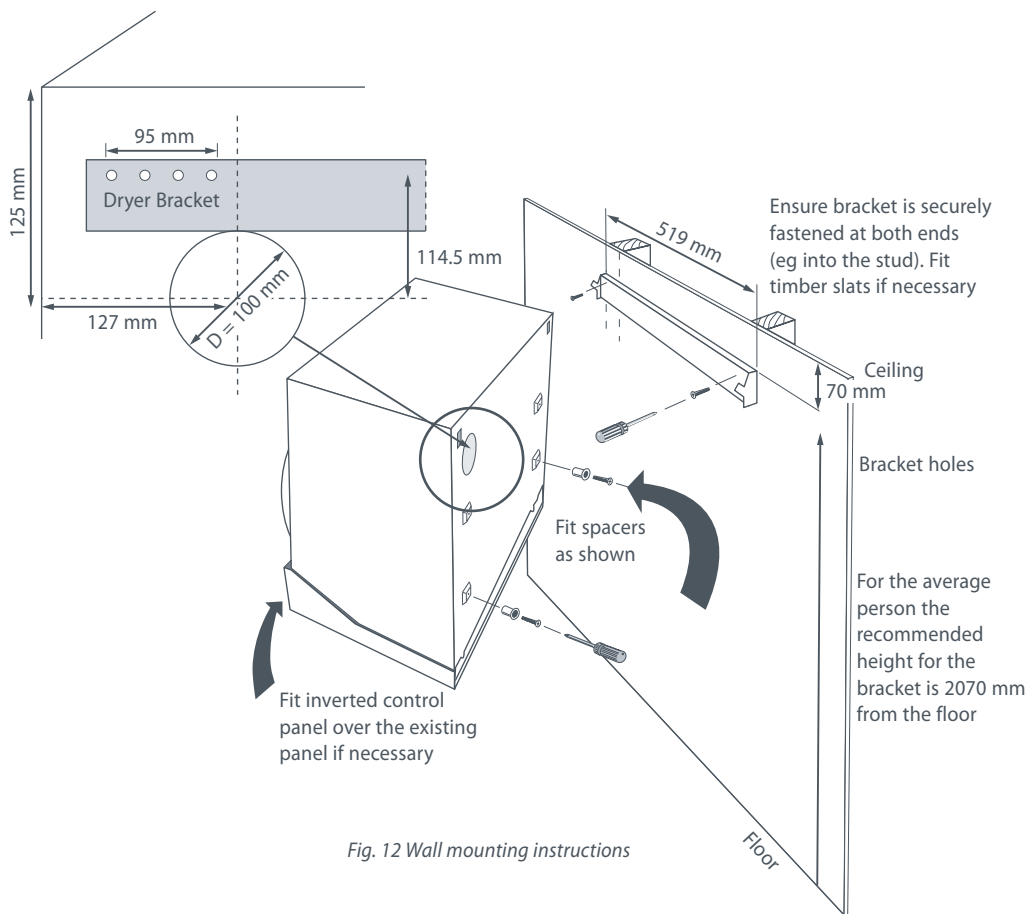

Fig. 12 Wall mounting instructions

Note: if you change mounting from upright to inverted or vice versa the dryer must be cleaned internally by a serviceman.

To get the most efficient use of your dryer we recommend you sort your loads.

Before drying

- Look for a care label on your clothes. This will tell you if they can be safely tumble dried.
- Close zippers, hooks and eyes, etc to reduce snagging and tangling.

Drying times

- Drying very small loads is inefficient. Try to dry medium to large loads.
- Sort your clothes into loads that take a similar time to dry eg heavier items (towels, T-shirts, flannelette sheets) from light items (synthetics and polycotton sheets and shirts). This will prevent some garments becoming overdried while others are still damp.
- Spin clothes at the highest spin speed suitable for the load type. The more water you remove in the wash, the less time it will need to dry. (NEVER put dripping wet clothes in or on top of the dryer as excessive water could cause an electrical hazard.)

Lint

- Dry lint givers and lint collectors separately.

Lint Givers	Lint Collectors
Towels	Synthetics
Chenille	Corduroy
Nappies	Poly Cotton
	Socks

To reduce creasing

- Shake clothes out and load individually to help clothes dry evenly.
- Launder permanent press garments separately eg business shirts.
- Allow enough room for clothes to tumble freely when loading.
- Hang garments as soon as the dryer cycle is completed to reduce the need for ironing.

12 Cleaning the lint filter

Electronic and Manual 4.5 kg dryers

It is important to clean the lint filter regularly, as the lint produced in the drying process can become a fire hazard if it is allowed to accumulate in or around your dryer.

The lint filter is located in the door opening.

- 1 Remove the lint filter, open it out and wipe clean with your hand.
- 2 Close the lint filter and place it back in the opening.

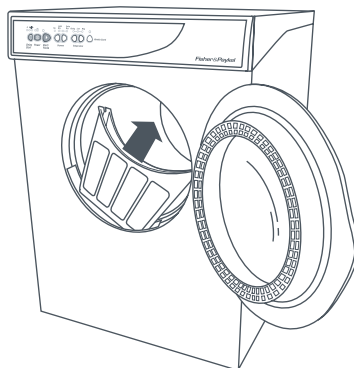

Fig. 13 Lint filter – 4.5 kg dryers

Manual 3.5 kg dryers

The lint filter is located on the door of the dryer behind the directional outlet grill.

- 1 To remove the outlet grill grasp the hub in the centre of the grill and pull. Wipe the filter clean with your hand.
- 2 To replace the grill, locate the hub over the boss in the centre of the door and push firmly.

Note: do not clean your lint filter by vacuuming or wetting it, as this may block the fine pores essential for maximum airflow.

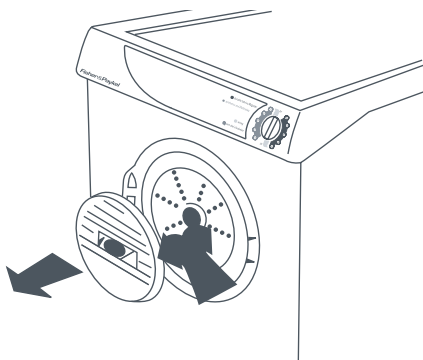

Fig. 14 Lint filter – Manual 3.5 kg dryer

Your Electronic dryer takes the guess work out of choosing drying times by sensing the dryness of the load. When your dryer senses that the clothes have dried to the dryness level you have selected, the dryer will automatically turn itself off.

Using your dryer

- 1 Clean the lint filter before every load.
- 2 Load the clothes into the dryer.
- 3 Press POWER.
- 4 Select the dryness level.
- 5 Select the temperature setting and other drying options.
- 6 Press START/PAUSE.

The dryer will beep 5 times at the end of the cycle.

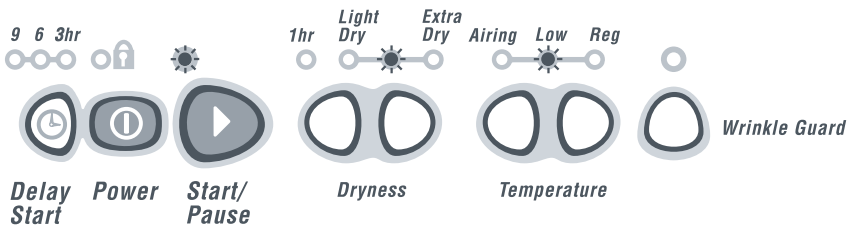

Fig. 15 Control panel – Electronic dryer

Dryness levels

The Electronic dryer has 5 dryness levels from Light Dry through to Extra Dry. Choose the dryness level to suit your load using the guide opposite. If you find the load is not dry enough, select the next dryness level up. The higher the level, the longer the drying time and the drier your clothes will be. Two lights are sometimes used to show the dryness level. For example the Light-Medium Dry and Medium-Extra Dry settings.

Light to Medium Settings

- Delicate fabrics eg synthetics
- Fabrics prone to shrinking eg sweatshirts
- Or if you want the clothes slightly damp for ironing

Medium to Extra Dry Settings

- Heavier fabrics eg towels
- Durable fabrics eg denim

Airing / Cool down

When the dryer has sensed that the load is dry it will automatically go into a 10 minute airing or cool down cycle. During airing the drum tumbles and cool air is blown through the clothes. This reduces creasing if the clothes are left in the dryer.

1 hour setting

The 1 hour setting is a manual cycle which dries continuously for 60 minutes. The manual cycle does not sense when your clothes are dry.

You can use the 1 hour setting when using a drying rack to dry shoes, hats and other items that are best dried without tumbling.

Note: it is important to check the clothes throughout the manual cycle to avoid overdrying.

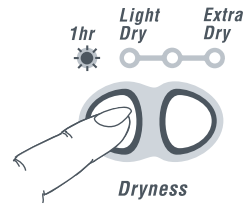

Key Lock

Setting Key Lock prevents the dryer from being accidentally switched off, or the programme being altered when the dryer is running.

- 1 Select drying cycle and press START/PAUSE.
- 2 Press KEY LOCK (the lock shaped button) and hold for 2 seconds.
- 3 The Key Lock light will flash and the dryer will give 2 quick beeps.
- 4 The Key Lock light will remain on and all other keys will now be locked.

To remove the key lock repeat steps 2 and 3.

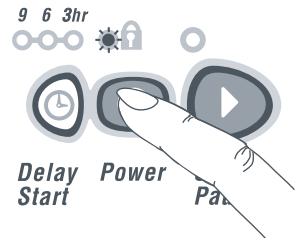

Pausing the dryer

Opening the door or pressing START/PAUSE will stop the dryer tumbling. To start again close the door and press START/PAUSE.

Note: if the door is opened when the dryer is running, and left open for more than 8 minutes, or the door is opened during airing the dryer will automatically switch off.

Drum reversal

To minimise tangling and to ensure your clothes dry efficiently, the dryer reverses the tumbling during the cycle.

Temperature settings

This dryer has 3 temperature settings; regular, low and airing.

- The REGULAR setting is for drying most fabrics.
- The LOW setting is for drying delicates and synthetics. It is half heat so the temperatures are lower for maximum care of the fabrics.
- The AIRING setting is a cycle designed to freshen up garments. The airing setting operates only on the 1 hour manual cycle.

The regular and low settings will operate on both the manual and the auto-sensing cycles.

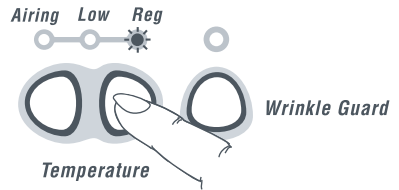

Delay start

DELAY START will delay the start of the drying cycle by 3, 6 or 9 hours.

- 1 Select drying cycle.
- 2 Press DELAY START once for a delay of 3 hours. Press again for 6 hours, a third time for 9 hours and again to return to normal.

Selecting DELAY START will cancel the 'beeping' at the end of the cycle.

Note: the DELAY START will not operate when the 1 hour manual cycle is selected.

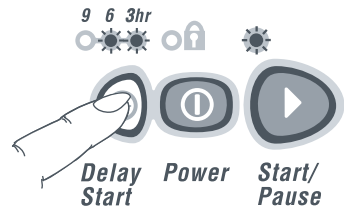

Important!

Do not leave non-colourfast materials to sit wet in the dryer as the dye may run.

Wrinkle guard

Use WRINKLE GUARD to minimise the creasing that occurs when the clothes are left to sit in the dryer.

At the end of the cycle the drum will rotate briefly every 5 minutes while cool air is blown through the clothes. WRINKLE GUARD will continue for 12 hours or until the dryer is turned off. The dryer will beep to remind you that the cycle is finished.

WRINKLE GUARD can be turned on or off at any time during the cycle.

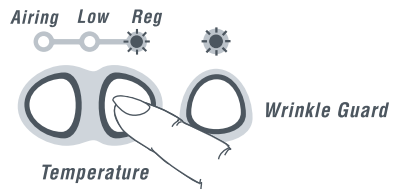

16 Manual dryers

The Manual dryers have been designed so you can select how long you want the clothes to dry for. So you know exactly when your clothes will be ready.

Using your dryer

- 1 Clean the lint filter before every load.
- 2 Load the clothes into the dryer.
- 3 Turning the knob clockwise only, select the desired cycle and drying time.
- 4 Try to remove the clothes from the dryer as soon as the cycle is completed to help prevent creasing.

Note: the 3.5 kg dryer will stop every 5 – 6 minutes, to allow clothes to redistribute.

Drying cycles

The Manual dryers have two drying cycles designed to take care of all your drying needs.

- The REGULAR cycle is for drying more durable fabric or garment types eg cotton, denim. Here the heater remains on until the airing phase of the cycle.
- The DELICATE cycle is for drying delicates and synthetics. Here the heater pulses on and off, so garments are dried at lower temperatures.

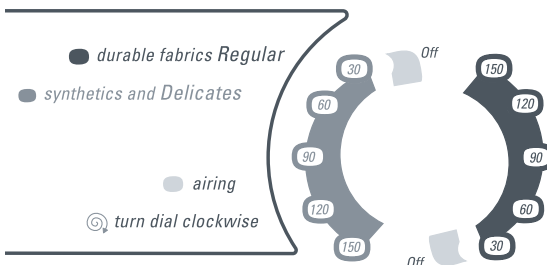

Fig. 16 Control panel – Manual dryer

Note: the dryers will not dry if the knob is turned anti-clockwise.

Airing / Cool down

When the Manual dryer has finished drying it will automatically go into a 13 – 15 minute airing or cool down cycle. During airing the drum tumbles and cool air is blown through the clothes. This reduces creasing if the clothes are left in the dryer.

This phase of the drying cycle can be used to air clothes.

Drying times

With your new dryer it may take a few trials before you can accurately predict the correct drying time for each individual load.

As a guide we have included some examples of loads and drying times. These times are approximate only, based on the garments being spun at the maximum spin speed suitable for the wash load.

Load comparison	Approximate drying times
7 Towels	60 – 80 mins
10 Shirts (cotton/polyester)	20 – 40 mins
4 T-shirts plus 5 Towels	60 – 80 mins
9 Small Delicates	20 – 30 mins

4.5 kg dryers only

A drying rack is available to dry shoes, hats and other items that are best dried without tumbling.

How to use the drying rack

- 1 Place the locating pin at the end of the drying rack into the hole in the centre of the rear of the dryer drum.
- 2 Adjust the rack so that it is flat.
- 3 For the Electronic dryer we recommend using the 1 hour manual cycle, and the low temperature setting (fully featured models).
For the Manual dryer we recommend using the Delicate cycle.

Important!

Check the articles throughout the cycle to avoid overdrying.

The dryer rack is an optional extra. (Part No. 427228). In New Zealand, contact your Fisher & Paykel Dealer. In Australia, contact Fisher & Paykel on 1300 650 590.

If your dryer is not operating properly use the checklist below to find the possible solution.

Pressing POWER or setting the timer does not turn the machine on.

Is the electrical cord plugged in?

Is the power switched on at the wall?

Is the door securely closed?

Could your household power supply be at fault. Try plugging in another electrical appliance.

Make sure the timer is not in the OFF position.

Clothes are still damp.

If you have turned the knob anti-clockwise on the Timer dryers the dryer will not dry.

Try selecting a higher dryness level.

Very small loads in the Electronic dryer may under-dry. Increase the load size.

Pressing START/PAUSE does not start the Electronic dryer.

Try pressing START/PAUSE again.

Has the KEY LOCK been set?

Dryer is taking a long time to dry.

Is the lint filter clean?

Is the airflow system free from obstruction?

The dryer keeps stopping and starting.

Has Wrinkle Guard been turned on?

The dryer is beeping and the pattern of lights is unfamiliar.

Turn the dryer off at the wall. Wait 15 seconds and turn it back on. Press POWER and restart.

If the problem persists contact your Dealer or Authorised Service Centre.

Manufacturers warranty

The purchaser automatically receives a 2 year Manufacturer's Warranty with the purchase of this Product covering parts and labour for servicing within the country of purchase.

Fisher & Paykel undertakes to:

Repair or, at its option, replace without cost to the owner either for material or labour any part of the Product, the serial number of which appears on the Product, which is found to be defective within TWO YEARS of the date of purchase.

This warranty DOES NOT cover

- A Service calls which are not related to any defect in the Product. The cost of a service call will be charged if the problem is found not to be a Product fault. For example:
 1. Correcting the installation of the Product.
 2. Instructing you how to use the Product.
 3. Replacing house fuses or correcting house wiring or plumbing.
 4. Correcting fault(s) caused by the user.
 5. Noise or vibration that is considered normal, eg drain/fan sounds, regeneration noises or user warning beeps.
 6. Correcting damage caused by pests, eg rats, cockroaches etc.
 7. Poor drying performance due to incorrect installation eg no venting system fitted, dryer vent against a wall, blocked lint filter.
 8. Poor drying performance due to incorrect loading eg overloading or underloading.
 9. Damage from articles in the drum eg bra wires, pens, crayons, dye transfer or flammable material.
 10. Dryer not heating due to timer knob being turned anticlockwise.
- B Defects caused by factors other than:
 1. Normal domestic use or
 2. Use in accordance with the Product's User Guide.
- C Defects to the Product caused by accident, neglect, misuse or Act of God.
- D The cost of repairs carried out by non-authorized repairers or the cost of correcting such unauthorised repairs.
- E Normal recommended maintenance as set out in the Product's User Guide.
- F Repairs when the appliance has been dismantled, repaired or serviced by other than an AUTHORISED CUSTOMER SERVICE CENTRE or the selling dealer.
- G Pick-up and delivery.
- H Transportation or travel costs involved in the repair when the Product is installed outside the AUTHORISED CUSTOMER SERVICE CENTRE'S normal service area.

An Authorised Service Agent must provide service under this Manufacturer's Warranty (Refer to the Customer care section at the back of this book). Such service shall be provided during normal business hours. This warranty certificate should be shown when making any claim.

Note

This Warranty is an extra benefit and does not affect your legal rights under local consumer laws and applies only to Product purchased in New Zealand and Australia.

Please keep this User Guide in a safe place.

Check the things you can do yourself. Refer to your User Guide and check:

- 1 Your appliance is correctly installed
- 2 You are familiar with its normal operation
- 3 You have read the Trouble Shooting section

If after checking these points you still need assistance please refer to the following:

In New Zealand if you need assistance...*

Call your Fisher & Paykel retailer who is trained to provide information on your appliance, or if we can be of any further help, please contact our Customer Care Centre,

Toll Free: 0800 FP CARE or 0800 37 2273 Fax: (09) 273 0656

Email: customer.care@fp.co.nz

Postal address: P.O.Box 58732, Greenmount, Auckland

If you need service...*

Fisher & Paykel has a network of independent Fisher & Paykel AUTHORISED SERVICE CENTRES whose fully trained technicians can carry out any service necessary on your appliance. Your dealer or our Customer Care Centre can recommend an AUTHORISED SERVICE CENTRE in your area.

In Australia if you need assistance...*

Call the Fisher & Paykel Customer Care Centre and talk to one of our Customer Care Consultants.

Toll Free: 1300 650 590

Fax: (07) 3826 9298

Email: customer.care@fp.com.au

Postal address: PO Box 798, Cleveland, QLD 4163

If you need service...*

Fisher & Paykel Australia Pty Ltd has a network of independent Fisher & Paykel AUTHORISED SERVICE CENTRES whose fully trained technicians can carry out any service necessary on your appliance. Our Customer Care Centre can recommend an AUTHORISED SERVICE CENTRE in your area.

*If you call or write, please provide: name, address, model number, serial number, date of purchase and a description of the problem. This information is needed in order to better respond to your request for assistance.

Product details can be found on a sticker situated on the back of the dryer cabinet, or on the inside of the dryer door.

Product details

Fisher & Paykel Appliances Ltd

Model/Serial No.

Date of Purchase _____ **Purchaser** _____

Dealer _____ **Suburb** _____

Town _____ **Country** _____

Copyright © Fisher & Paykel 2006. All rights reserved.

The product specifications in this booklet apply to the specific products and models described at the date of issue. Under our policy of continuous product improvement, these specifications may change at any time. You should therefore check with your Customer Care Centre to ensure this booklet correctly describes the product currently available.

www.fisherpaykel.com

NZ AU GB IE

Dryer

Installation instructions and user guide

Published: 12/2006

Part No. 427621 B

Free Manuals Download Website

<http://myh66.com>

<http://usermanuals.us>

<http://www.somanuals.com>

<http://www.4manuals.cc>

<http://www.manual-lib.com>

<http://www.404manual.com>

<http://www.luxmanual.com>

<http://aubethermostatmanual.com>

Golf course search by state

<http://golfingnear.com>

Email search by domain

<http://emailbydomain.com>

Auto manuals search

<http://auto.somanuals.com>

TV manuals search

<http://tv.somanuals.com>