

Installation instructions and user guide

Food waste disposer

GD50S1

NZ

Safety and warnings	2
Installation instructions	3
Operating instructions	8
Cleaning and maintenance	9
Troubleshooting	10
Manufacturer's warranty	11
Customer care	12

Important!

SAVE THESE INSTRUCTIONS

The models shown in this user guide may not be available in all markets and are subject to change at any time. For current details about model and specification availability in your country, please go to our website listed on the back cover or contact your local Fisher & Paykel dealer.

2 Safety and warnings

Use this appliance only for its intended purpose as described in this User Guide.

Important safety precautions !

When using this appliance, always use basic safety precautions, including the following:

Danger!

- This appliance is not intended for the use by children or infirmed persons without supervision.
- To reduce the risk of injury, close supervision is required when a waste disposer is used near children.
- Do not put fingers or hands into the waste disposer.
- Unplug the unit before attempting to clear a jam or remove an object from the disposer.
- As the waste disposer is magnetic, use only non-magnetic tools such as a wooden spoon or long handled plastic tongs when attempting to loosen a jam or remove objects from the waste disposer.
- To reduce the risk of injury by materials that may be expelled by a waste disposer, do not put non-food items, or any of the following into the food waste disposer:
 - a) Shells, such as mussel or oyster shells.
 - b) Caustic drain cleaners or similar products.
 - c) Glass, china or plastic.
 - d) Large whole bones.
 - e) Metal, such as bottle caps, tin cans, utensils or aluminium foil.
 - f) Hot grease or other hot liquids.
 - g) Whole corn husks or similar fibrous material.
- When not operating the waste disposer, leave the drain stopper in place to reduce the risk of objects falling into the disposer.
- Your new appliance must be properly installed in accordance with the installation instructions before it is used.
- Never unplug the waste disposer by pulling on the power cord.
- Always grip the plug firmly and pull straight from the outlet.
- Repair or replace immediately all electric service cords that have become frayed or otherwise damaged.
- Power cords must be replaced by a qualified electrician or authorised service engineer.
- Do not use a cord that shows cracks or abrasion along it's length or at either the plug or appliance end.

! WARNING!



Electrical Shock Hazard

To reduce the risk of electric shock or injury to persons, read the IMPORTANT SAFETY PRECAUTIONS before operating this appliance.

SAVE THESE INSTRUCTIONS

Before you begin

Please read these installation instructions completely and carefully.

- The following installation instructions are intended as a general guide.
- Please ensure that the waste disposal unit is installed according to local building codes for your area.
- Installation is recommended to be done by a qualified plumber or installer.
- Product failure due to improper installation is not covered under the Warranty.

Preparation

Removing an existing waste disposer, if installed

- 1 Disconnect electrical power supply to existing disposer.
- 2 Remove old disposer or sink flange assembly.
- 3 Inspect drain line. If it is heavily coated with hardened grease and accumulations, clear out the build-up using a plumber's rod or auger.
- 4 Remove old sealing materials and gaskets from sink opening, both top and bottom.

What you will need

- Phillips screwdriver
- Flat blade screwdriver
- Steel Punch or wooden dowel
- Petroleum jelly or liquid soap
- Plumber's Putty

Important!

Top and bottom of sink and sink flange surfaces must be free of any materials to prevent leaks.

4 Installation instructions

Unpacking your waste disposer

- 1 Remove the waste disposer from the packaging.
- 2 Identify and check that all components are included in the carton before beginning the installation (fig. 1).
- 3 Take care not to misplace any of the components.

Components

1. Stopper
2. Sink flange
3. Rubber gasket
4. Flange ring
5. Protector ring
6. Mount ring
7. Screw clamp
8. Hopper with splash guard
9. Dishwasher discharge inlet
10. Drain housing
11. Reset button
12. Lower shell
13. End Bell (Electrical Connections)
14. Power cord
15. Outlet gasket
16. Discharge waste elbow
17. Waste elbow flange nut

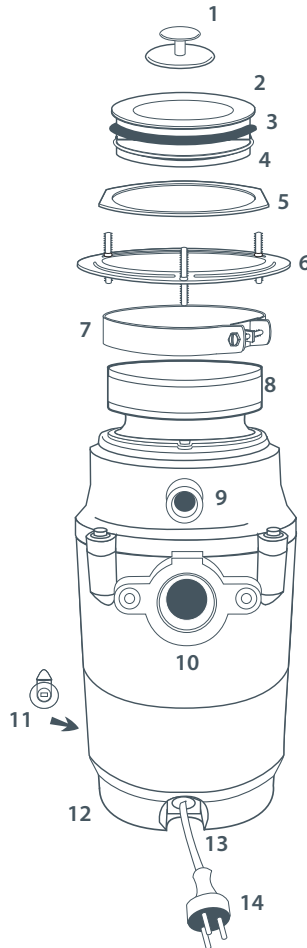

Fig 1. Three Bolt Mount System

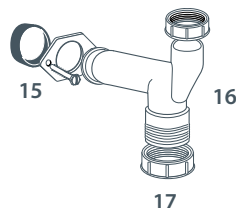

Fig 1.2. Elbow

Installation

- 1 Loosen the clamp screw to allow the mounting system to be removed (fig.2).
- 2 Turn the mounting assembly over and remove the flange ring from the track on the sink flange. Undo the three screws holding it together. This will allow the sink flange, mount ring, and protector ring to separate (fig 3). Use the flat blade screwdriver as a lever if required.
- 3 Apply a small amount of plumbers putty to the lip of the flange and position the sink flange into the sink drain hole ensuring that the rubber gasket on the underside of the sink flange is firmly in place (fig.4).
- 4 Approaching from under the sink, slide the protector ring and mount ring onto the underside of the sink flange. Fit the flange ring into the track on the sink flange, then tighten the 3 mounting screws evenly and securely (fig.5).

Note:

Ensure that the mounting assembly connection is fixed securely and tightly.

No dishwasher connection required

If a dishwasher is not being connected, please proceed to step 7.

Connecting to a dishwasher

If you are connecting to a dishwasher, please continue with steps 5 & 6.

- 5 Using a blunt instrument (steel punch or wooden dowel), knock out the entire plug at the end of the dishwasher drain inlet (as shown in fig.6). Do not use a screwdriver or sharp instrument. When the knockout plug falls into disposer, you may remove it or simply grind it up when the disposer is used. This will not damage the disposer in any way, but may take some time to grind, over the course of several uses.
- 6 Connect the dishwasher drain hose to the dishwasher inlet pipe on the waste disposer (fig. 6). Use a clamp to ensure a tight seal. A stepped rubber adaptor (not supplied with the product) may be required if the diameter of the drain hose is larger than the diameter of the waste disposer's inlet connection.

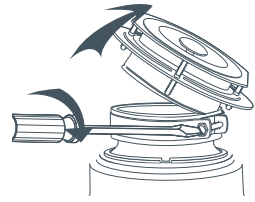

Fig. 2 Removing the mounting system from the waste disposer

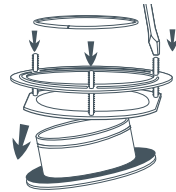

Fig. 3 Disassembling the mounting system

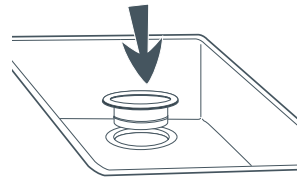

Fig. 4 Fitting the flange into the sink drain hole

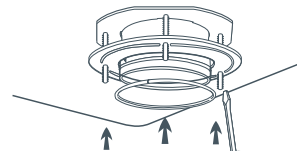

Fig. 5 Fixing the mounting system to the underside of the sink

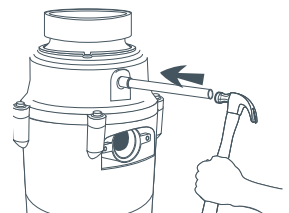

Fig. 6 Connecting to a dishwasher (if required)

6 Installation instructions

- 7 Connect the discharge elbow to the lower outlet on the waste disposer (fig. 7).
- 8 Prior to connecting the waste disposer to the mounting assembly, press firmly down on the rubber splash guard to check that it is firmly fitted onto the neck of the hopper.
- 9 Lubricate the top lip and angled surface of the rubber splash guard with liquid soap or petroleum jelly (fig. 8).

Important!

Please do not remove clamp and splash guard from hopper. Both parts are factory installed and installation ready.

- 10 Align the discharge elbow up with the waste pipe (refer to fig.11) so that the waste disposer is correctly positioned, prior to engaging with the mounting assembly.
- 11 Guide the waste disposer up to the sink flange (fig. 9). Engage the groove of the splash guard around the ridge at the bottom of the sink flange. A slight rocking motion may be required to help ensure a proper fit.
- 12 While still supporting the body of the waste disposer, tighten the screw clamp around the rubber splash guard (fig.10). The waste disposer will now hang by itself.
- 13 Connect the discharge elbow up with the waste pipe (fig.11) and tighten the slip nut on the drain pipe.

Note:

If you need to rotate the waste disposer to connect with the waste pipe, it is important to make sure the sink flange does not turn. Movement of the sink flange will break the seal. If this occurs, disengage the waste disposer from the discharge elbow and mounting assembly. Return to step 10 to realign the waste disposer before repeating steps 11-13.

Important!

Ensure that the reset button is readily accessible after installation of the waste disposer.

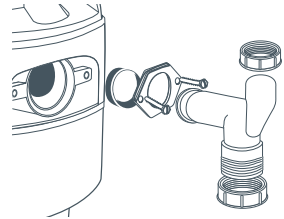

Fig. 7 Connecting the discharge elbow

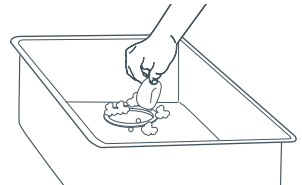

Fig. 8 Lubricate the rubber splash guard

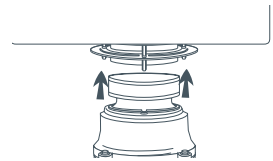

Fig. 9 Engage the waste disposer

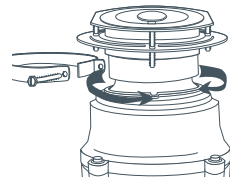

Fig. 10 Tightening the clamp

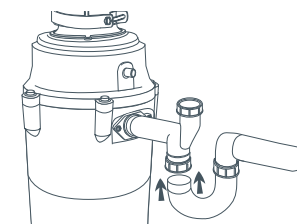

Fig. 11 Connecting the drain outlet

Controlling the waste disposer

All electrical connections **MUST** be done by a registered electrician. The waste disposer must be connected to the power supply by an earthed 3-pin outlet socket, mounted adjacent to the waste disposer under the sink.

Wall mounted switch

The waste disposer can be controlled by means of a wall mounted power switch, positioned 500mm minimum away from the sink.

Bench mounted air switch

An alternative option to a wall mounted control switch is a bench mounted air switch positioned within easy reach next to the sink.

We recommend using an Easy Fit by Fisher & Paykel Air Switch, which is available as an optional accessory from your Fisher & Paykel retailer or can be purchased through Fisher & Paykel Spare Parts (Part no. 2001105).

Operating instructions

- 1 Remove the sink stopper and turn on a medium flow of cold water.

Note:

Do not use hot water. Only cold water should be run through the waste disposer.

- 2 Press the wall mounted control switch, or an air switch if fitted, to activate the waste disposer.
- 3 Feed food items through the sink opening of the waste disposer gradually.

Note:

Overloading the waste disposer with too much food waste at once may cause the blades to jam and the disposer to shut down. The overload button may be required to be reset. Refer to the Overload Reset button section on page 9.

Caution!

Do not put hands or fingers into the waste disposer.

- 4 Before turning the waste disposer off, let the water and the disposer run for approximately half a minute after shredding stops. This assures that all the food waste is thoroughly flushed through the trap and drain.

Helpful Hints

- If a dishwasher drain hose has been connected to the waste disposer, be sure that the waste disposer's chamber is empty before using the dishwasher to ensure the dishwasher is able to drain properly.
- It is recommended to leave the stopper in the drain when the disposer is not in use to prevent utensils and foreign objects from falling into the waste disposer.
- The waste disposer is designed to give you years of trouble-free service. The grinding mechanism is built to handle all normal food wastes, but WILL NOT grind and dispose of items such as tin cans, bottles, bottle caps, glass, china, leather, large bones, mussel or oyster shells. These are waste materials that should be collected with your household rubbish.
- We recommend cutting or breaking up items which require considerable grinding time, such as melon rinds, grapefruit skins, small bones and corn cob husks or dispose of these items with your household waste collection.

Your waste disposer is self-cleaning and scours itself with each use. Under normal usage, your waste disposer will not require any special care.

Note:

Always run cold water into the chamber before, during and after using the waste disposer. Do not use hot water.

Removing an odour

- Grinding up a tray of ice cubes will help to clean the shredding plate.
- Running orange or lemon rinds through the waste disposer will help to freshen up the grinding chamber.

Note:

- Do not pour bleach or drain cleaners, into the waste disposer
- Never put corrosive substances or chemicals into the waste disposer.

Unblocking a jam

- 1 Before investigating a blockage, you **MUST** disconnect the power supply.
- 2 The waste disposer is magnetic. **ALWAYS** use non-magnetic tools, such as a wooden spoon or long handled plastic tongs when attempting to loosen a jam or remove an object from the waste disposer.
- 3 After clearing the blockage or jam, turn the power back on, turn on a medium flow of cold water and run the waste disposer for half a minute to ensure that all the food waste is thoroughly flushed through the trap and drain.

Note:

If the motor does not start when activated, refer to the Overload Reset Button section below or the Troubleshooting guide on page 9.

Overload Reset button

The waste disposer is fitted with an overload control which prevents the motor from operating should overloading occur.

Overloading occurs when the motor is unable to turn, usually caused by a foreign object falling in to the chamber or too much food waste being fed through into the chamber at once, jamming the shredding plate. When overloaded the motor will stop automatically. To restart the motor the overload reset button must be pressed.

The reset overload button is a small red button located opposite the power cord outlet, near the bottom of the waste disposer. Before resetting the overload button, you **MUST** disconnect the power supply.

Important!

The motor is permanently lubricated for life. Do not attempt to lubricate your waste disposer.

Troubleshooting tips

Problem	Possible causes	What to do
Waste disposer is not starting	No electricity at the power outlet	Check that the plug is correctly connected and power is turned on Check another appliance at the same outlet Check house fuse
	Foreign object may be lodged between the turntable and grinding ring	Turn power supply and water tap off. Rotate the turntable, using a plastic, wooden or non-magnetic implement to dislodge the foreign object
	Grinding chamber may be overloaded with food waste or foreign matter	Turn the power and water tap off and, using a plastic, wooden or non-magnetic implement, remove the food waste or foreign matter. Refer to the operating instructions section
	Safety overload button may have tripped	The reset overload button is a red button located externally, opposite the power cord outlet, near the bottom of the waste disposer
Abnormal noise when operating	A spoon, bottle cap or other foreign object may have fallen into the waste disposer	Turn power supply and water tap off. Wait until grinding blades and turntable has stopped turning. Use a plastic, wooden or non-magnetic implement to remove the foreign object
Waste disposer is jammed	Foreign object may be lodged between the turntable and grinding ring	Turn power supply and water tap off. Rotate the turntable, using a plastic, wooden or non-magnetic implement to dislodge the foreign object
Unit is leaking at the top connections	Improper seating of the sink flange	Check that the sink flange is centred and sealed tightly into the sink drain by the mounting assembly from underneath. Refer to step 2 of the installation instructions
	Improperly installed rubber gasket	Check that the rubber gasket is sitting flat under the lip of the sink flange. Refer to step 2 of the installation instructions
	Mount ring not tightened properly	Discharge outlet elbow may not be tightened. Check the discharge elbow is tight. Refer to step 13 of the installation instructions
Unit is leaking at the discharge outlet	Discharge outlet elbow may not be tightened	Check the discharge elbow is tight. Refer to step 13 of the installation instructions
Water is slow to drain from the sink	Rubber splash guard fingers trapping air inside the chamber	When the rubber splash guard is new, air can become trapped within the chamber preventing water from draining quickly. Pushing food through the rubber splash guard will release the air and the water will drain. Over time, the splash guard fingers will soften and flex, holding back less air and aiding drainage

Fisher & Paykel undertakes to

Repair or, at its option, replace without cost to the owner either for material or labour any part of the Product, the serial number of which appears on the Product, which is found to be defective within TWO YEARS from the date of purchase.

This warranty DOES NOT Cover

- A Service calls which are not related to any defect in the Product. The cost of a service call will be charged if the problem is not found to be a Product related fault. For example:
 - 1. Correct the installation of the product.
 - 2. Instruct you how to use the product.
 - 3. Replace house fuses or correct house wiring.
 - 4. Correcting fault(s) caused by the user.
 - 5. Correcting damage caused by pests, eg. rats, cockroaches etc.
- B Defects caused by factors other than:
 - 1. Normal domestic use or
 - 2. Use in accordance with the Product's User Guide.
- C Defects to the Product caused by accident, neglect, misuse or 'Act of God'.
- D The cost of repairs carried out by non-authorized repairers or the cost of correcting such unauthorised repairs.
- E Normal recommended maintenance as set out in the Product's User Guide.
- F Repairs when the appliance has been dismantled, repaired or serviced by other than a Fisher & Paykel AUTHORISED CUSTOMER SERVICE CENTRE or the selling dealer.
- G Pick up and delivery.
- H Transportation or travelling costs involved in the repair when the product is installed outside the Fisher & Paykel AUTHORISED CUSTOMER SERVICE CENTRE'S normal service area.

Service under this manufacturer's warranty must be provided by an Authorised Service Agent (refer to the Customer care section for contact details). Such service shall be provided during normal business hours. This warranty certificate should be shown when making any claim.

Note:

This Warranty is an extra benefit and does not affect your legal rights and applies only to product purchased in New Zealand and Australia.

Please keep this User Guide in a safe place.

Do not return to Fisher & Paykel.

Check the things you can do yourself.
Refer to your User Guide and check:



- 1 your appliance is correctly installed
- 2 you are familiar with its normal operation

If after checking these points you still need assistance, please refer to your nearest Authorised Service Centre, or contact us through our local website listed on the back cover.

In New Zealand if you need assistance...*

Call your Fisher & Paykel retailer who is trained to provide information on your appliance, or if we can be of any further help, please contact our Customer Care Centre,

Toll Free: 0800 FP CARE or 0800 37 22 73 **Fax:** (09) 273 0656

Email: customer.care@fp.co.nz

Postal address: P.O. Box 58732, Greenmount, Auckland

If you need service...*

Fisher & Paykel has a network of independent Fisher & Paykel Authorised Service Centres whose fully trained technicians can carry out any service necessary on your appliance. Your dealer or our Customer Care Centre can recommend an Authorised Service Centre in your area.

In Australia if you need assistance...*

Call the Fisher & Paykel Customer Care Centre and talk to one of our Customer Care Consultants.

Toll Free: 13 00 650 590 **Fax:** (07) 3826 9298

Email: customer.care@fp.com.au

Postal Address: PO Box 798, Cleveland QLD 4163

If you need service...*

Fisher & Paykel Australia Pty Ltd has a network of independent Fisher & Paykel Authorised Service Centres whose fully trained technicians can carry out any service necessary on your appliance. Our Customer Care Centre can recommend an Authorised Service Centre in your area.

*If you call or write, please provide: name, address, model number, serial number, date of purchase and a description of the problem. This information is needed in order to better respond to your request for assistance.

Product Details

Fisher & Paykel Appliances Ltd

Model/Serial No. _____

Date of Purchase _____ **Purchaser** _____

Dealer _____ **Suburb** _____

Town _____ **Country** _____

Copyright © Fisher & Paykel 2008. All rights reserved.
The product specifications in this booklet apply to the specific products and models described at the date of issue. Under our policy of continuous product improvement, these specifications may change at any time. You should therefore check with your Dealer to ensure this booklet correctly describes the product currently available.

www.elba.co.nz

NZ

Food waste disposer installation
and user guide

Published: 09/2008

Part No. 791633

Free Manuals Download Website

<http://myh66.com>

<http://usermanuals.us>

<http://www.somanuals.com>

<http://www.4manuals.cc>

<http://www.manual-lib.com>

<http://www.404manual.com>

<http://www.luxmanual.com>

<http://aubethermostatmanual.com>

Golf course search by state

<http://golfingnear.com>

Email search by domain

<http://emailbydomain.com>

Auto manuals search

<http://auto.somanuals.com>

TV manuals search

<http://tv.somanuals.com>